

THIS DRAWING IS UNPUBLISHED. RELEASED FOR PUBLICATION. ALL RIGHTS RESERVED.

REVISIONS				
#	LTR	DESCRIPTION	DATE	BY
P2		REVISED PER ECO-11-004587	11MAR11	RK HMR
R		REVISED PER ECO-18-000976	13APR2018	RS JO

- 1 OBSOLETE PART NO.
- 2 'AMP', PART NUMBER AND DATE CODE MARKED WHEN HOUSING SIZE PERMITS.
- 3 .046±.015 CHARS. MARKED FIRST AND EVERY 5TH CAVITY, ONE SIDE.
- 5 SUPERSEDED BY 3-87456-3.
- 6 SUPERSEDED BY 4-87456-5.
- 7 OBSOLETE PARTS: OBSOLETE CIS STREAMLINING PER D.RENAUD/D.SINISI

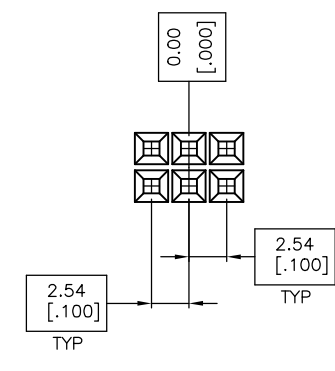
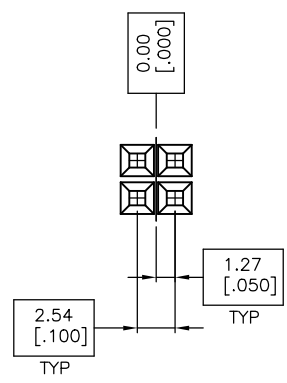
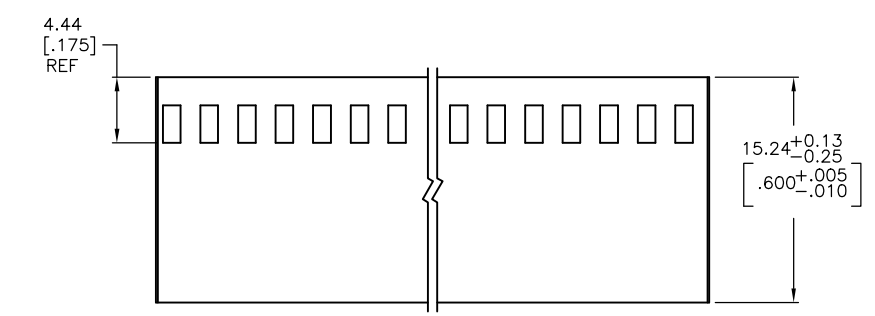
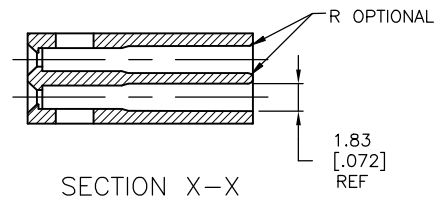
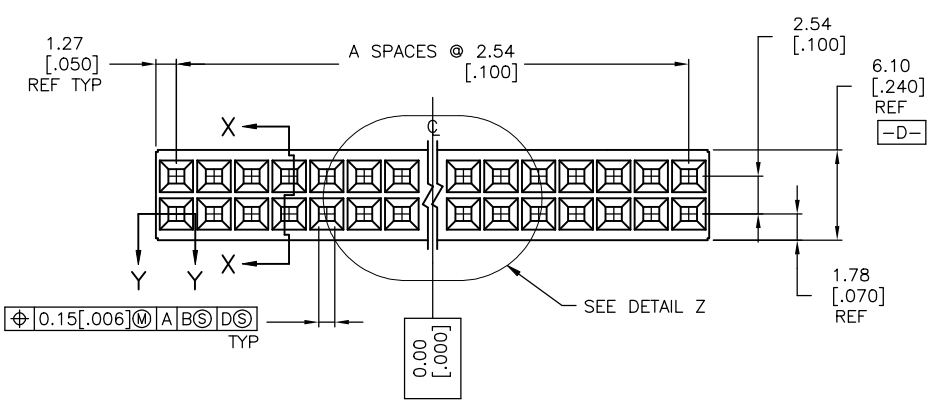
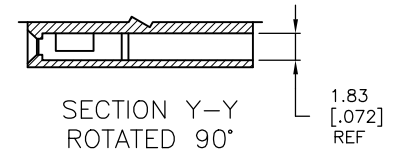
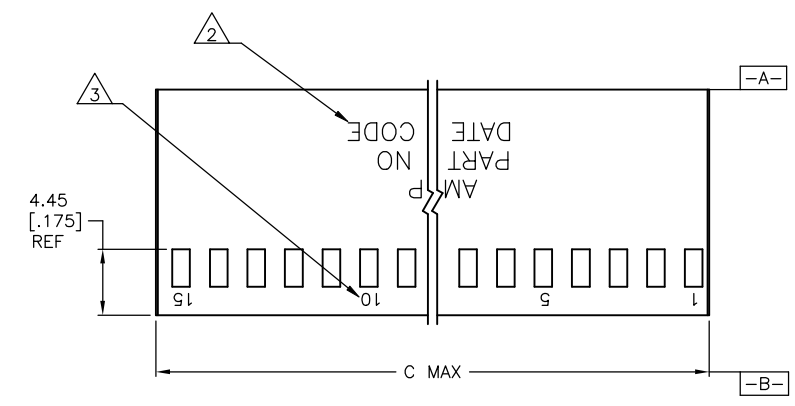

DETAIL Z

6-87456-5	81.28 [3.200]	31	64	6-87456-6
6-87456-3	73.66 [2.900]	28	58	6-87456-4
6-87456-1	71.12 [2.800]	27	56	6-87456-2
5-87456-9	60.96 [2.400]	23	48	6-87456-0
5-87456-7	83.82 [3.300]	32	66	5-87456-4
5-87456-5	88.90 [3.505]	34	70	5-87456-6
5-87456-3	2.67 [.105]	-	2	-
5-87456-1	76.33 [3.005]	29	60	5-87456-2
4-87456-9	5.21 [.205]	1	4	5-87456-0
4-87456-7	91.57 [3.605]	35	72	4-87456-8
4-87456-5	68.71 [2.705]	26	54	4-87456-6
4-87456-3	53.47 [2.105]	20	42	4-87456-4
4-87456-1	66.17 [2.605]	25	52	4-87456-2
3-87456-9	63.63 [2.505]	24	50	4-87456-0
3-87456-7	56.01 [2.205]	21	44	3-87456-8
3-87456-5	50.93 [2.005]	19	40	3-87456-6
3-87456-3	48.39 [1.905]	18	38	3-87456-4
3-87456-1	45.85 [1.805]	17	36	3-87456-2
2-87456-9	43.31 [1.705]	16	34	3-87456-0
2-87456-7	40.77 [1.605]	15	32	2-87456-8
2-87456-5	38.23 [1.505]	14	30	2-87456-6
2-87456-3	35.69 [1.405]	13	28	2-87456-4
2-87456-1	33.15 [1.305]	12	26	2-87456-2
1-87456-9	30.61 [1.205]	11	24	2-87456-0
1-87456-7	28.07 [1.105]	10	22	1-87456-8
1-87456-5	25.53 [1.005]	9	20	1-87456-6
1-87456-3	22.99 [.905]	8	18	1-87456-4
1-87456-1	20.45 [.805]	7	16	1-87456-2
87456-9	17.91 [.705]	6	14	1-87456-0
87456-7	15.37 [.605]	5	12	87456-8
87456-5	12.83 [.505]	4	10	87456-6
87456-3	10.29 [.405]	3	8	87456-4
87456-1	7.75 [.305]	2	6	87456-2
PART NO. WITHOUT MARKING	C	A	NO. OF POSITIONS	PART NO. MARKED

THIS DRAWING IS A CONTROLLED DOCUMENT. E. BRANDBERG 11-06-92, J. GESFORD 11-30-92, J. GESFORD 11-30-92

TE Connectivity Ltd.

HOUSING, MOD IV
DOUBLE ROW, .100X.100 C/L
CRIMP SNAP-IN, SHORT ENTRY

SIZE: A1 00779 C-87456

SCALE: 4:1 SHEET 1 OF 1

X-ON Electronics

Largest Supplier of Electrical and Electronic Components

Click to view similar products for [Headers & Wire Housings](#) category:

Click to view products by [TE Connectivity](#) manufacturer:

Other Similar products are found below :

[892-18-020-10-001101](#) [58102-G61-06LF](#) [582553-1](#) [0009485154](#) [009176003701906](#) [0050291907](#) [LY20-4P-DT1-P1E-BR](#) [02.125.8002.8](#)
[609-3404](#) [61062-3](#) [61082-181009](#) [622-3653LF](#) [63453-116](#) [636-1030](#) [636-1427](#) [636-3427](#) [636-4007](#) [641938-9](#) [641991-4](#) [644827-2](#) [65817-010LF](#) [65817-015LF](#) [65863-015LF](#) [66207-023LF](#) [67095-007LF](#) [67601157](#) [68645-018](#) [68648-049](#) [70.362.1628.0](#) [70-4210](#) [70-4226B](#) [70-4853B](#) [707-5020](#) [707-5028](#) [71.350.2428.0](#) [71918-208LF](#) [71961-016LF](#) [733-134](#) [733-162](#) [754199-000](#) [760-3052](#) [787-8014-00](#) [79531-3000](#)
[FCN-360C032-B](#) [FCN-367T-T012/H](#) [FCN-723D010/2](#) [80.063.4001.1](#) [800-90-001-10-001000](#) [800-90-010-10-002000](#) [801-43-002-10-013000](#)