

Three Phase High Performance EMI Filter – Bookshelf Type Dual Stage WYE Configuration

DATASHEET

High performance filters with bookshelf design is designed for motor drive applications requiring minimum space and convenient installation with superior performance at significant interference levels.



Approvals & Compliance

UL Recognised



CSA Certified



Features

- High Performance Dual Stage
- Bookshelf Design with neutral
- Compact / Light Weight / Cost effective

Typical Circuit Diagram

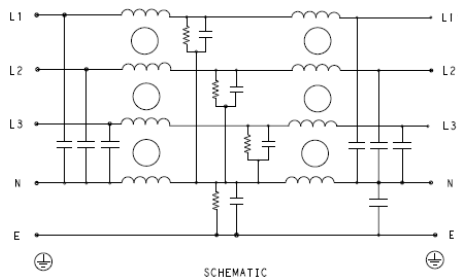

Applications

- AC/Dc Drives
- HVAC
- Robotics
- UPS

Specifications

Electrical Characteristics

Maximum Continuous Operating Voltage	440/520VAC
Current Ratings	7A to 150A @40°C, Din Mount 7A to 100A@40°C
Operating Frequency	50/60Hz
High Potential Test Voltage -440VAC	Line to Ground 2632VDC for 1 Minute
	Line to Line 1892VDC for 1 Minute
High Potential Test Voltage -520VAC	Line to Ground 2856VDC for 1 Minute
	Line to Line 2236VDC for 1 Minute
Overload Capability	135% of Rated current for 15 minutes

Functional Characteristics

Operating Temperature Range	-25°C to +85°C
Climatic Category	25/85/21
Termination	Shock Proof
Flammability corresponding to	UL 94 V-0

Reference Standards

Design Corresponding to	UL 60939-3 and CSA 22.2 No.8-13
-------------------------	---------------------------------

Selection Table – Standard Version





TE Ordering Number	Catalog Number	Rated Current @40°C	Rated Voltage @40°C	Leakage Current (mA)	Termination 	Weight (Kgs)
2-1609998-0	7KEVD10ABSW	7A	440 VAC	5	41	1.5
2-1609998-1	16KEVD10ABSW	16A	440 VAC	5	41	2
2-1609998-2	30KEVD10ABSW	30A	440 VAC	5	41	2.2
2-1609998-3	42KEVD10ABSW	42A	440 VAC	11	10	3
2-1609998-4	55KEVD10ABSW	55A	440 VAC	11	10	3
2-1609998-5	75KEVD10ABSW	75A	440 VAC	11	16	4
2-1609998-6	100KEVD10ABSW	100A	440 VAC	11	25	4
2-1609998-7	125KEVD10ABSW	125A	440 VAC	11	50	8
2-1609998-8	150KEVD10ABSW	150A	440 VAC	11	50	10
5-1609998-0	7KEVD10BBSW	7A	520 VAC	5	41	1.5
5-1609998-1	16KEVD10BBSW	16A	520 VAC	5	41	2
5-1609998-2	30KEVD10BBSW	30A	520 VAC	5	41	2.2
5-1609998-3	42KEVD10BBSW	42A	520 VAC	11	10	3
5-1609998-4	55KEVD10BBSW	55A	520 VAC	11	10	3
5-1609998-5	75KEVD10BBSW	75A	520 VAC	11	16	4
5-1609998-6	100KEVD10BBSW	100A	520 VAC	11	25	4
5-1609998-7	125KEVD10BBSW	125A	520 VAC	11	50	8
5-1609998-8	150KEVD10BBSW	150A	520 VAC	11	50	10

KEV-BS SERIES

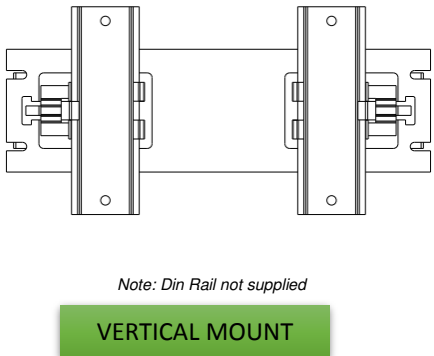
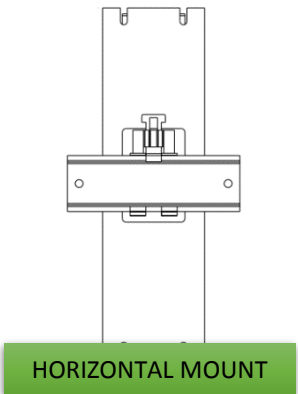

Selection Table – Din Rail Mount



TE Ordering Number	Part Number	Din Type	Rated Current @40°C	Rated Voltage @40°C	Leakage Current (mA)	Termination 	Weight (Kgs)
3-1609998-0	7KEVD10ABSWHM	HORIZONTAL	7A	440 VAC	5	41	1.6
3-1609998-1	16KEVD10ABSWHM	HORIZONTAL	16A	440 VAC	5	41	2.1
3-1609998-2	30KEVD10ABSWHM	HORIZONTAL	30A	440 VAC	5	41	2.3
3-1609998-3	7KEVD10ABSWVM	VERTICAL	7A	440 VAC	5	41	1.7
3-1609998-4	16KEVD10ABSWVM	VERTICAL	16A	440 VAC	5	41	2.2
3-1609998-5	30KEVD10ABSWVM	VERTICAL	30A	440 VAC	5	41	2.4
3-1609998-6	42KEVD10ABSWHM	HORIZONTAL	42A	440 VAC	11	10	3.2
3-1609998-7	55KEVD10ABSWHM	HORIZONTAL	55A	440 VAC	11	10	3.2
3-1609998-8	75KEVD10ABSWHM	HORIZONTAL	75A	440 VAC	11	16	4.2
3-1609998-9	100KEVD10ABSWHM	HORIZONTAL	100A	440 VAC	11	25	4.2
6-1609998-0	7KEVD10BBSWHM	HORIZONTAL	7A	520 VAC	5	41	1.6
6-1609998-1	16KEVD10BBSWHM	HORIZONTAL	16A	520 VAC	5	41	2.1
6-1609998-2	30KEVD10BBSWHM	HORIZONTAL	30A	520 VAC	5	41	2.3
6-1609998-3	7KEVD10BBSWVM	VERTICAL	7A	520 VAC	5	41	1.7
6-1609998-4	16KEVD10BBSWVM	VERTICAL	16A	520 VAC	5	41	2.2
6-1609998-5	30KEVD10BBSWVM	VERTICAL	30A	520 VAC	5	41	2.4
6-1609998-6	42KEVD10BBSWHM	HORIZONTAL	42A	520 VAC	11	10	3.2
6-1609998-7	55KEVD10BBSWHM	HORIZONTAL	55A	520 VAC	11	10	3.2
6-1609998-8	75KEVD10BBSWHM	HORIZONTAL	75A	520 VAC	11	16	4.2
6-1609998-9	100KEVD10BBSWHM	HORIZONTAL	100A	520 VAC	11	25	4.2

Connectors Cross Section

	41	10	16	25	50
Wire Section (mm ²)	4mm ²	10 mm ²	16 mm ²	25 mm ²	50 mm ²
Wire Section (AWG)	12AWG	8 AWG	6 AWG	4 AWG	1/0 AWG
Wire Stripping	Max 10mm	max 13.5 mm	max 17 mm	max 17 mm	max 20 mm
Max Recommended Torque	0.5 Nm / 4.5 in.lbs	1.2 Nm / 10.8 in.lbs	2÷2.2 Nm / 18÷19.8 in.lbs	2 Nm / 18 in.lbs	6 Nm / 54 in.lbs

Insertion Loss (Typical) – Measured in Closed 50Ω System

Common Mode 50Ω / 50Ω

		Frequency in MHz								
		0.01	0.05	0.15	0.5	1	3	5	10	30
Current Rating	7A	70	70	72	78	72	62	54	45	25
	16A	72	70	68	70	74	65	58	46	24
	30A	49	50	60	79	77	64	56	48	34
	42A	50	50	61	75	78	65	57	46	32
	55A	41	40	26	30	32	50	52	49	22
	75A	42	40	28	32	35	51	50	46	21
	100A	40	37	42	32	36	48	50	46	20
	125A	39	41	50	66	60	50	45	37	17
	150A	31	33	44	61	56	47	43	36	21

Differential Mode 50Ω / 50Ω

		Frequency in MHz								
		0.01	0.05	0.15	0.5	1	3	5	10	30
Current Rating	7A	50	52	36	50	50	46	40	26	30
	16A	56	50	38	51	52	48	42	28	32
	30A	31	34	48	83	80	57	45	23	25
	42A	32	32	50	80	75	72	46	26	22
	55A	30	35	20	22	34	45	48	26	27
	75A	40	38	25	21	34	46	48	30	24
	100A	45	40	50	25	32	50	47	32	22
	125A	49	50	54	53	45	33	26	19	19
	150A	44	45	43	56	47	33	27	22	22

Common Mode Insertion Loss (Typical in dB – refer to Table above)

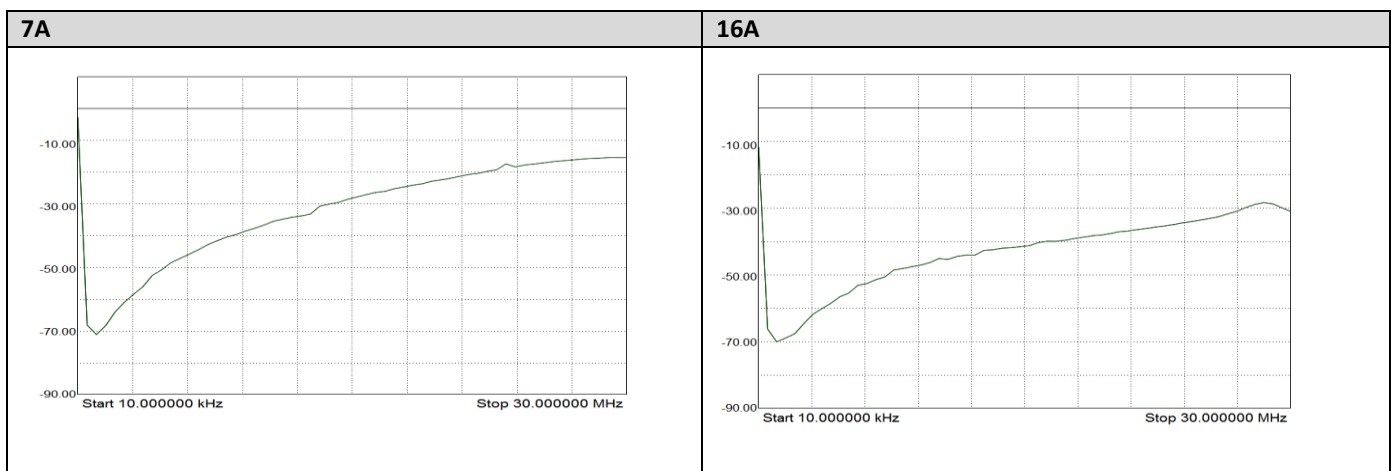

KEV-BS SERIES

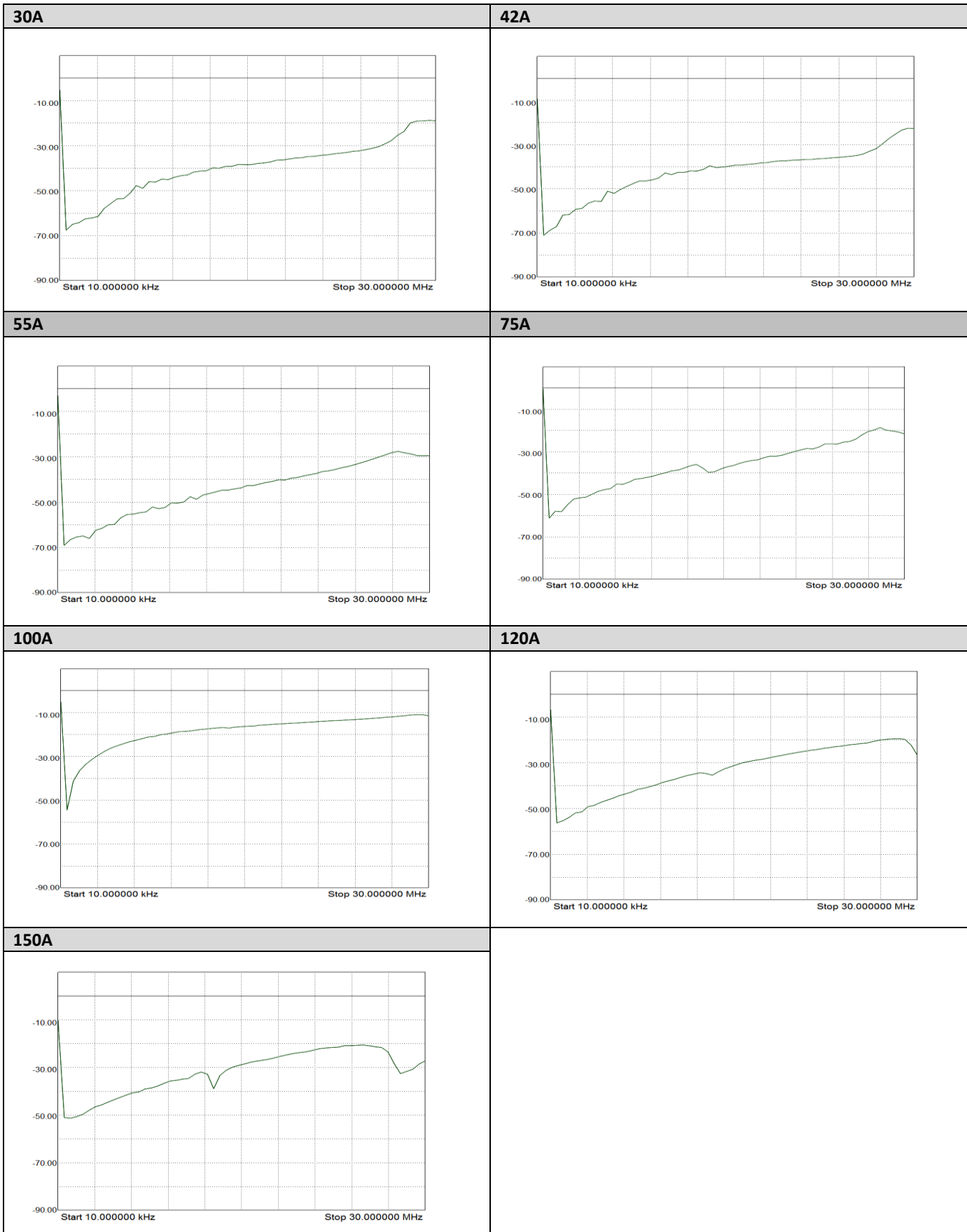

Case Dimensions – Standard Dimension

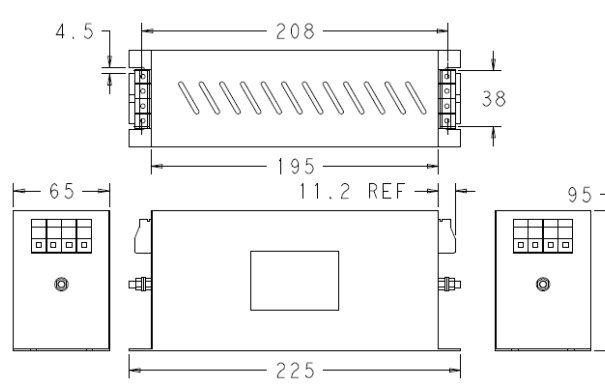
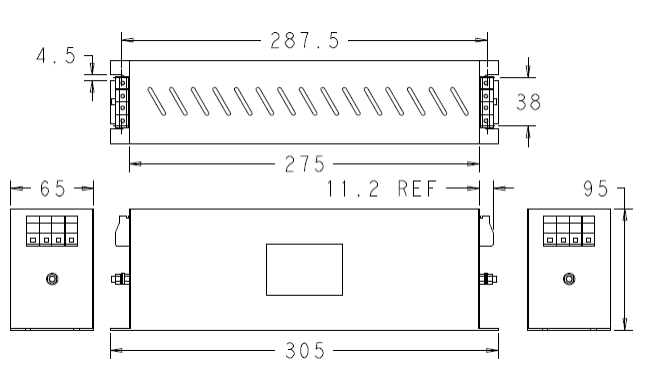
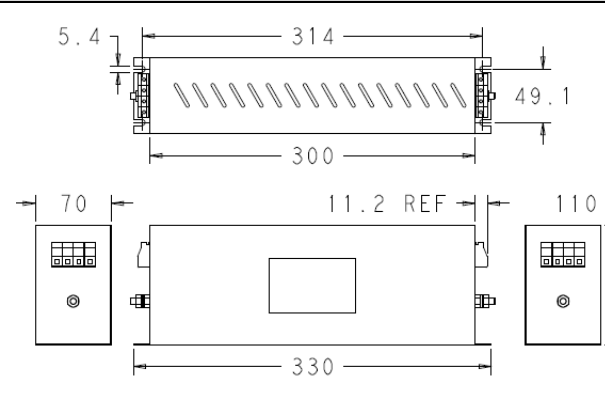
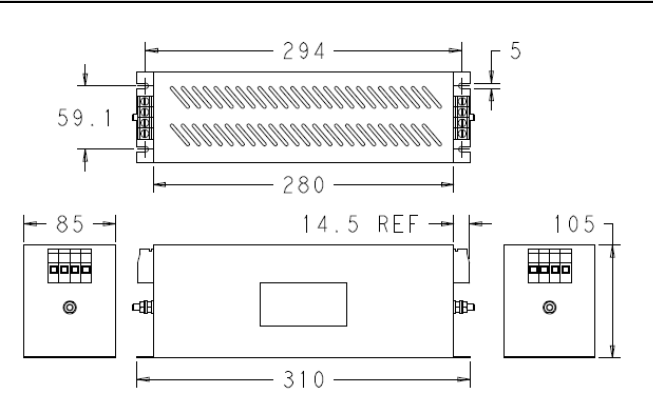
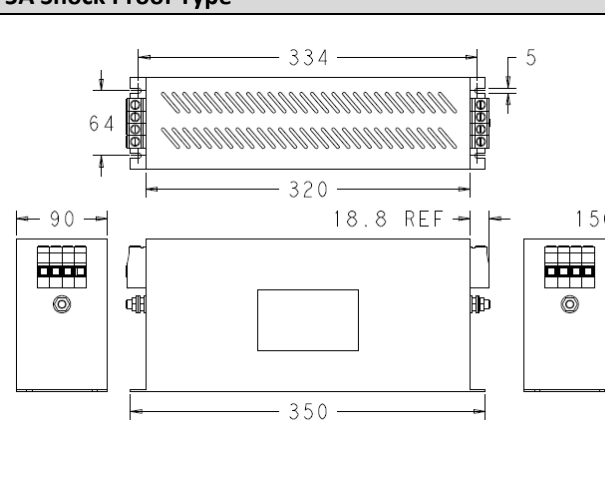
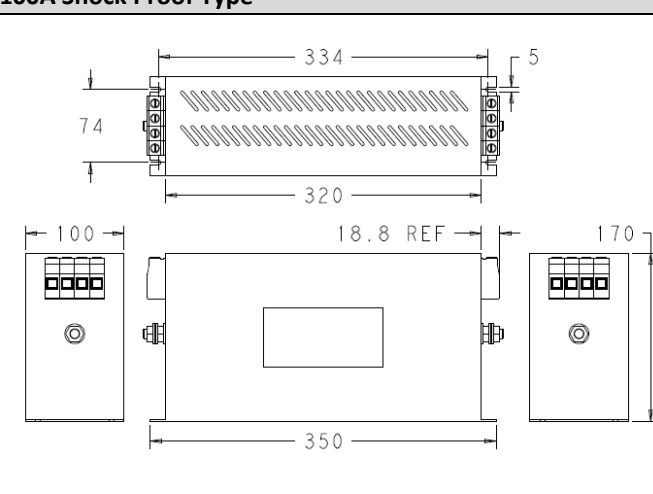
<p>7A Shock Proof Type</p> 	<p>16A Shock Proof Type</p> 
<p>30A to 42A Shock Proof Types</p> 	<p>55A Shock Proof Type</p> 
<p>75A Shock Proof Type</p> 	<p>100A Shock Proof Type</p> 

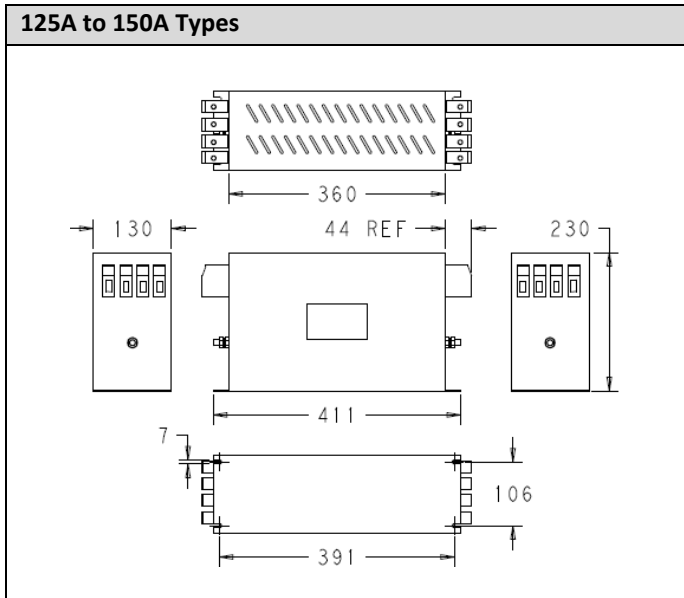

Case Dimensions – Din Rail Mount

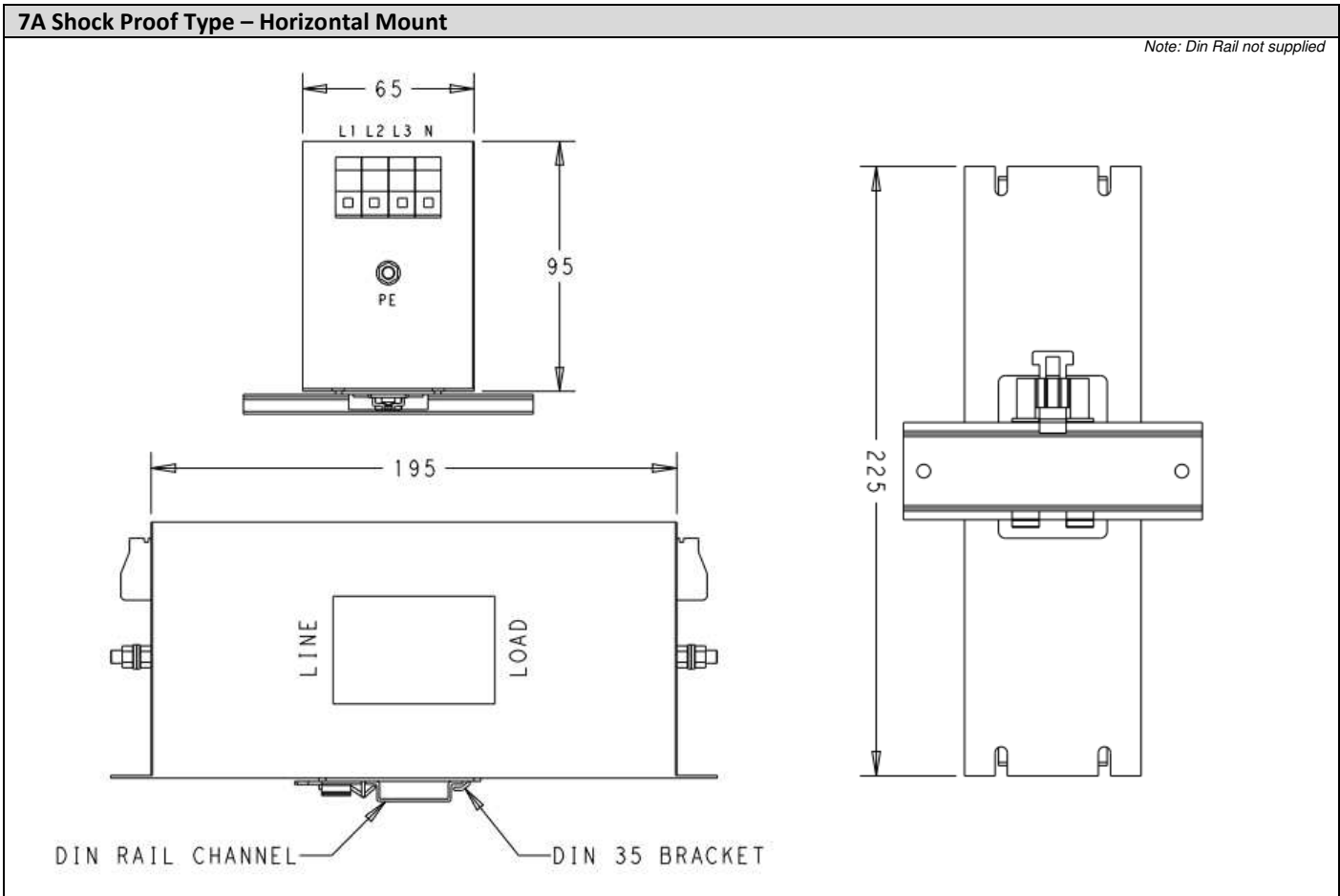

KEV-BS SERIES



7A Shock Proof Type – Vertical Mount

Note: Din Rail not supplied

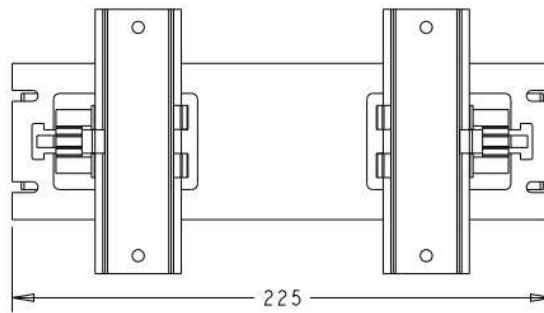
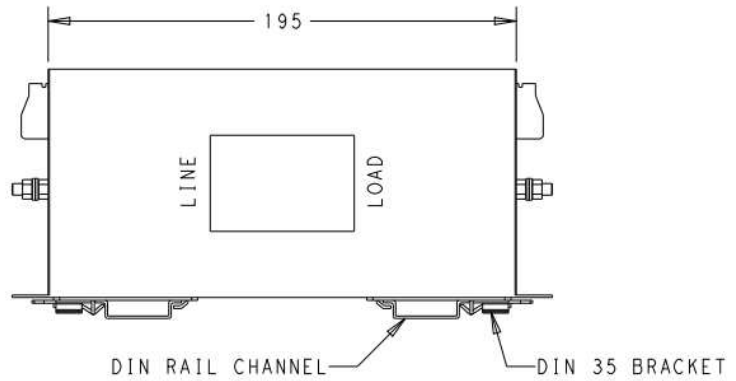
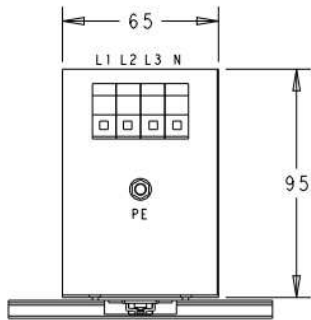

16A Shock Proof Type – Horizontal Mount

Note: Din Rail not supplied

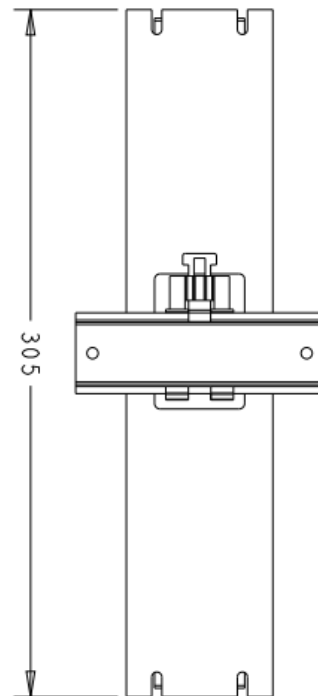
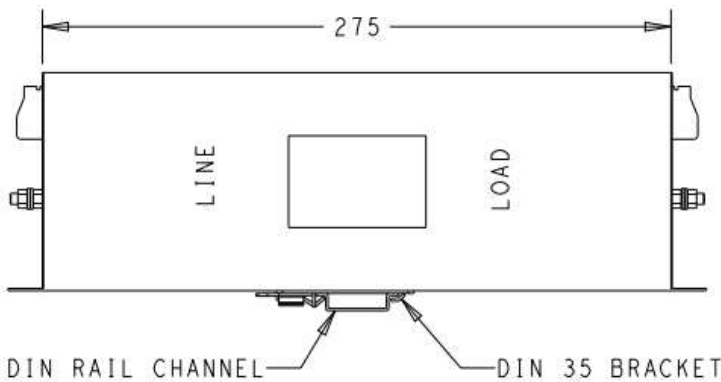
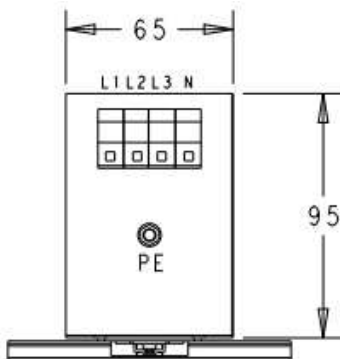

KEV-BS SERIES



16A Shock Proof Type – Vertical Mount

Note: Din Rail not supplied

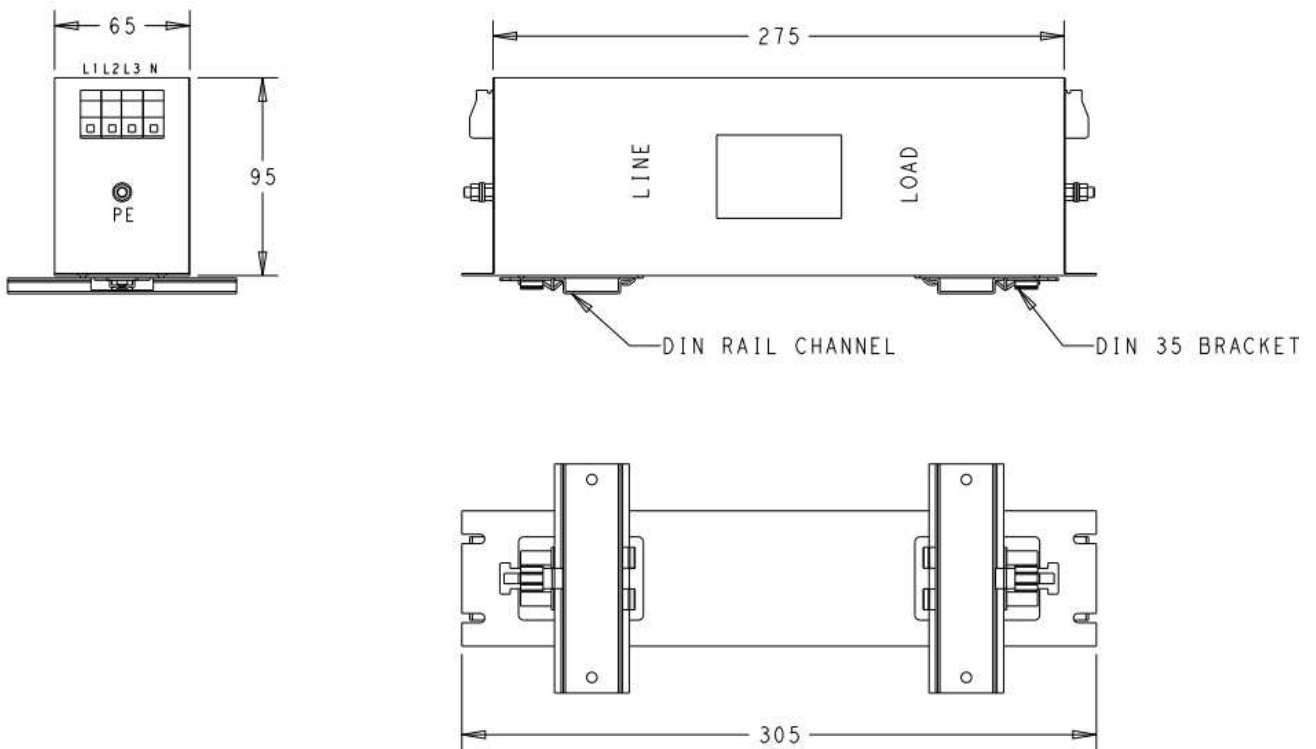

30A Shock Proof Type – Horizontal Mount

Note: Din Rail not supplied

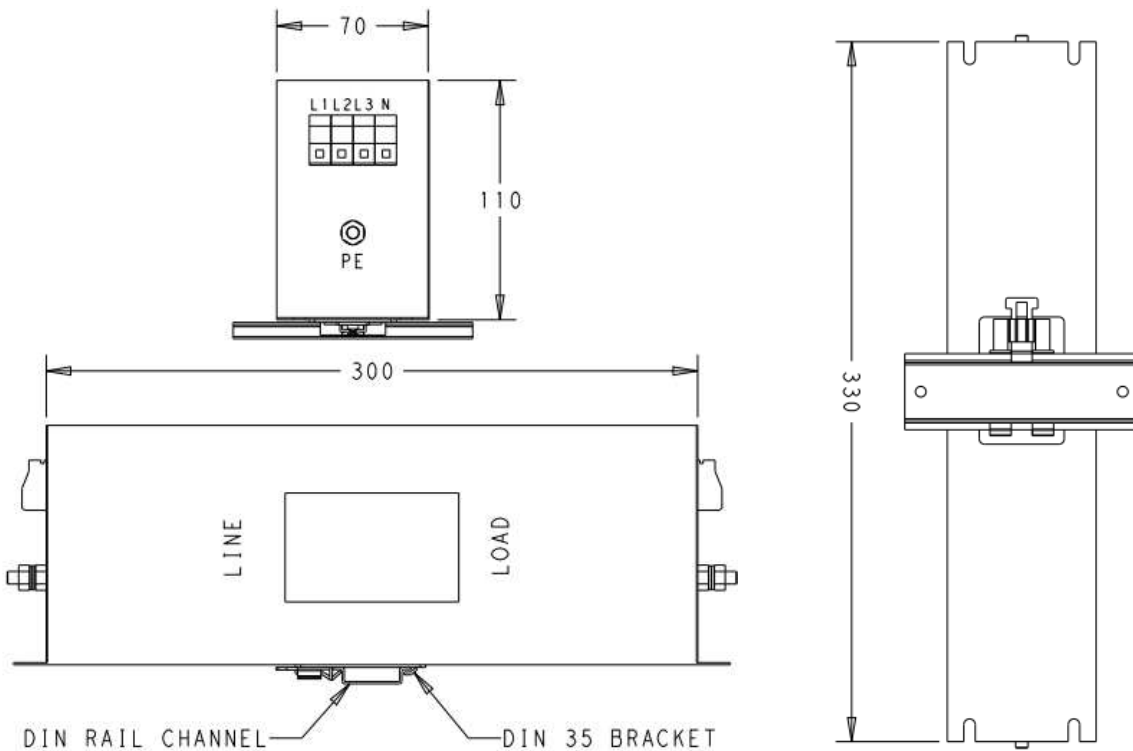

KEV-BS SERIES



30A Shock Proof Type – Vertical Mount

Note: Din Rail not supplied

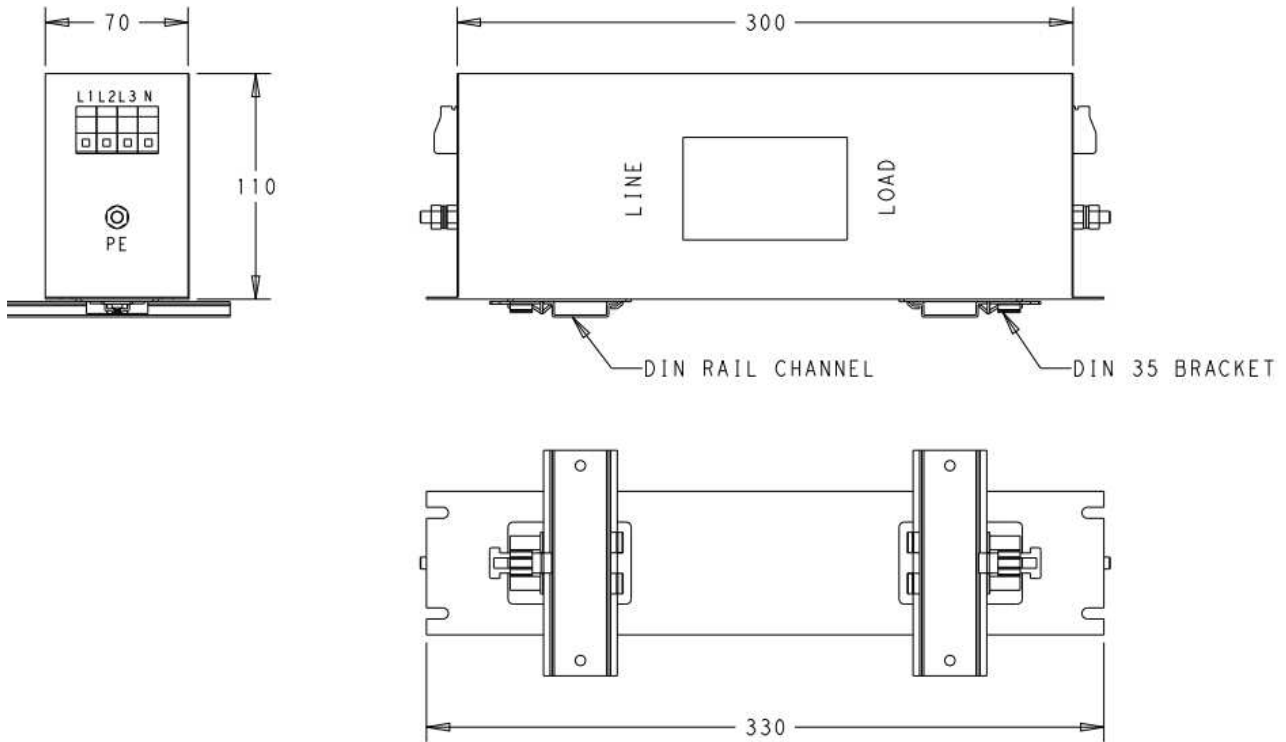

42A Shock Proof Type – Horizontal Mount

Note: Din Rail not supplied

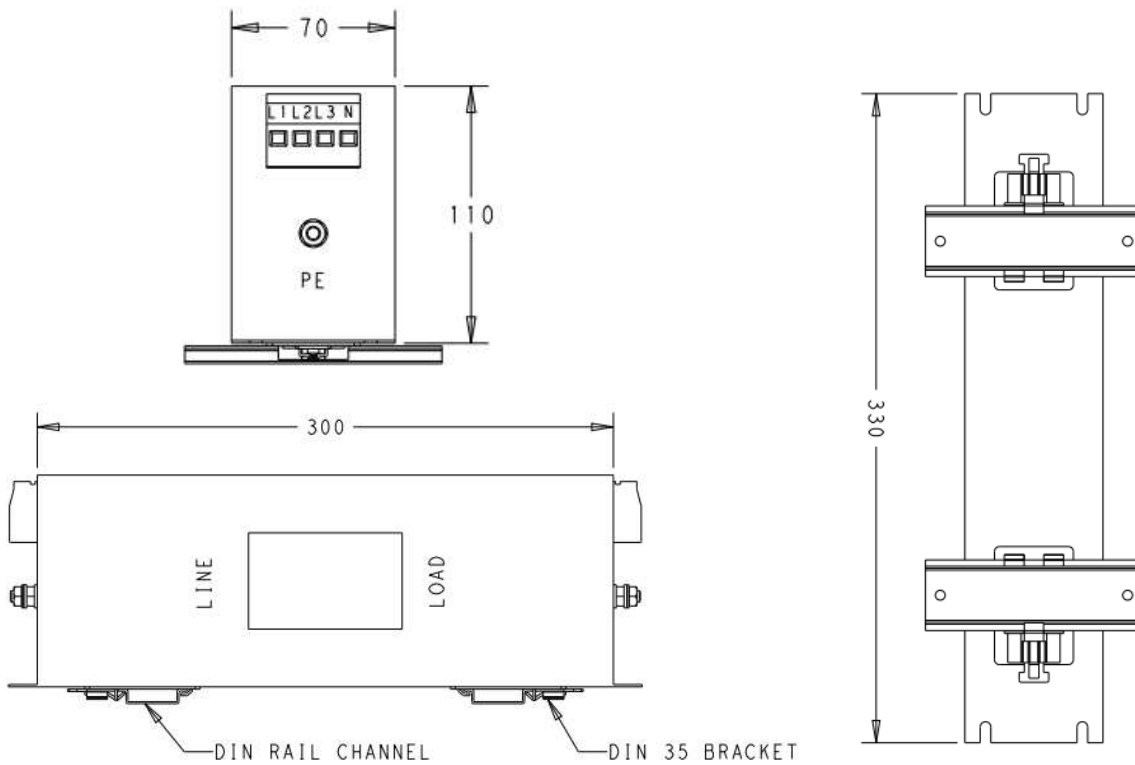

KEV-BS SERIES



55A Shock Proof Type – Horizontal Mount

Note: Din Rail not supplied

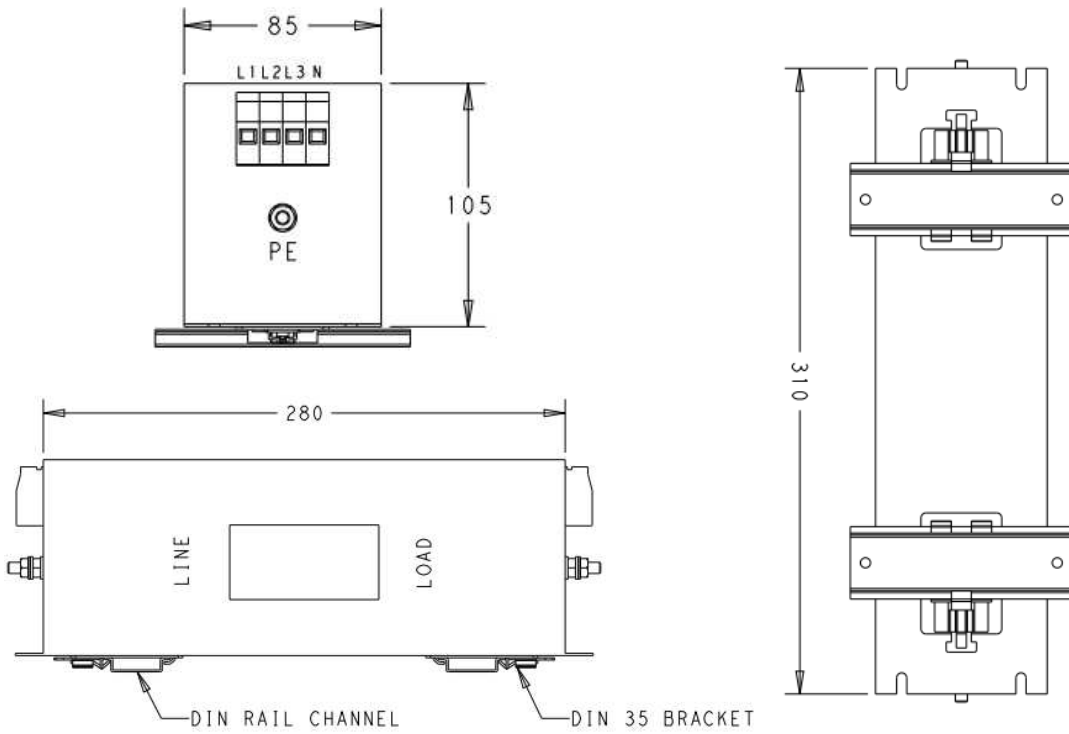

75A Shock Proof Type – Horizontal Mount

Note: Din Rail not supplied

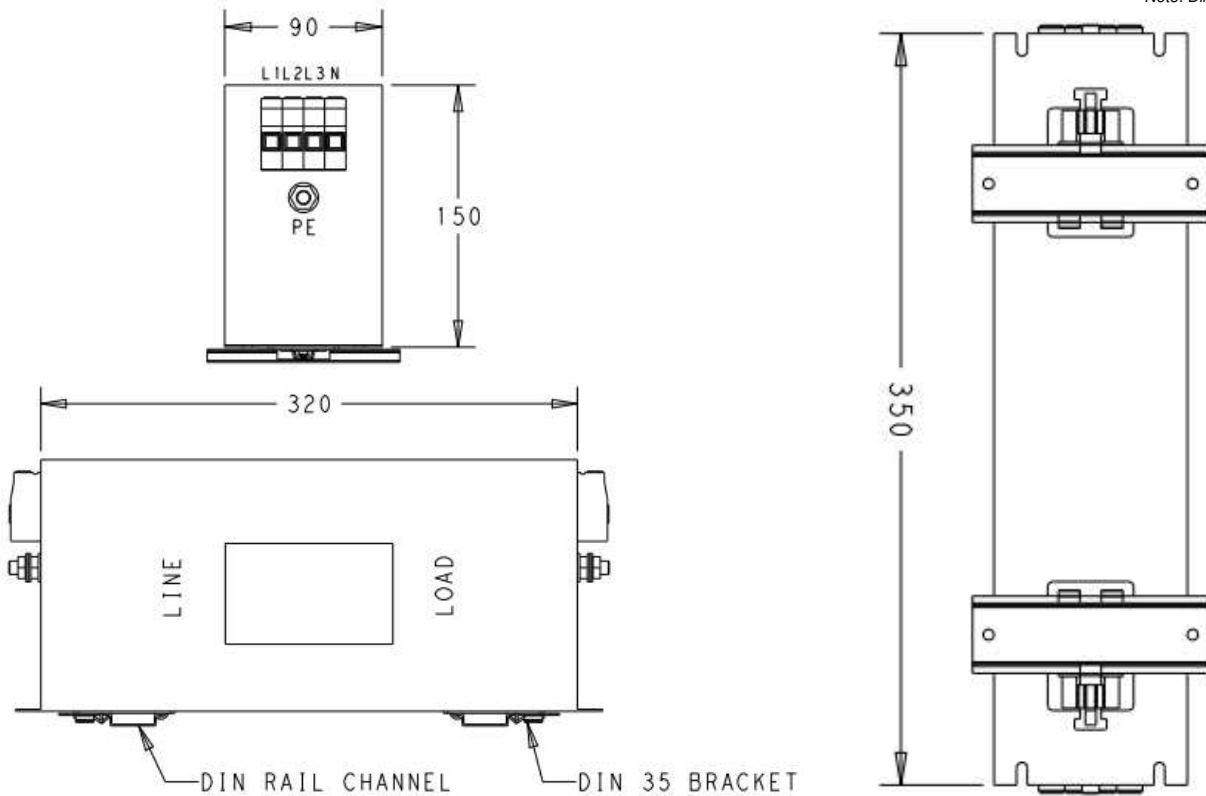

KEV-BS SERIES



100A Shock Proof Type – Horizontal Mount

Note: Din Rail not supplied

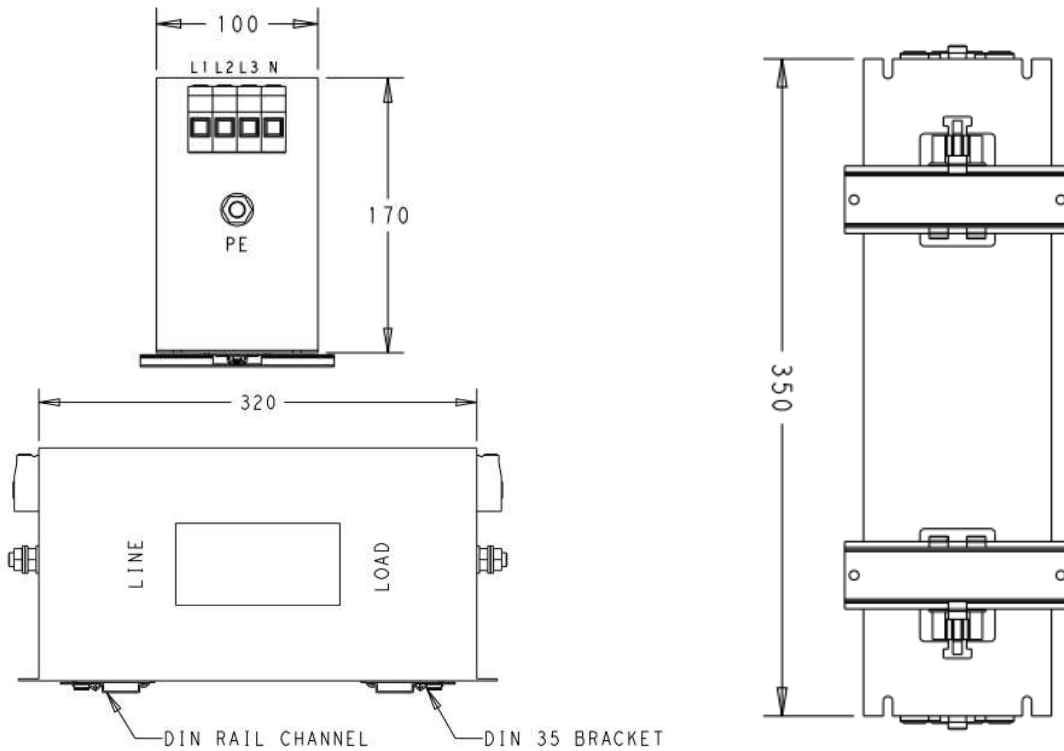

All dimensions in mm; Tolerances according: ISO2768-m

How to Order

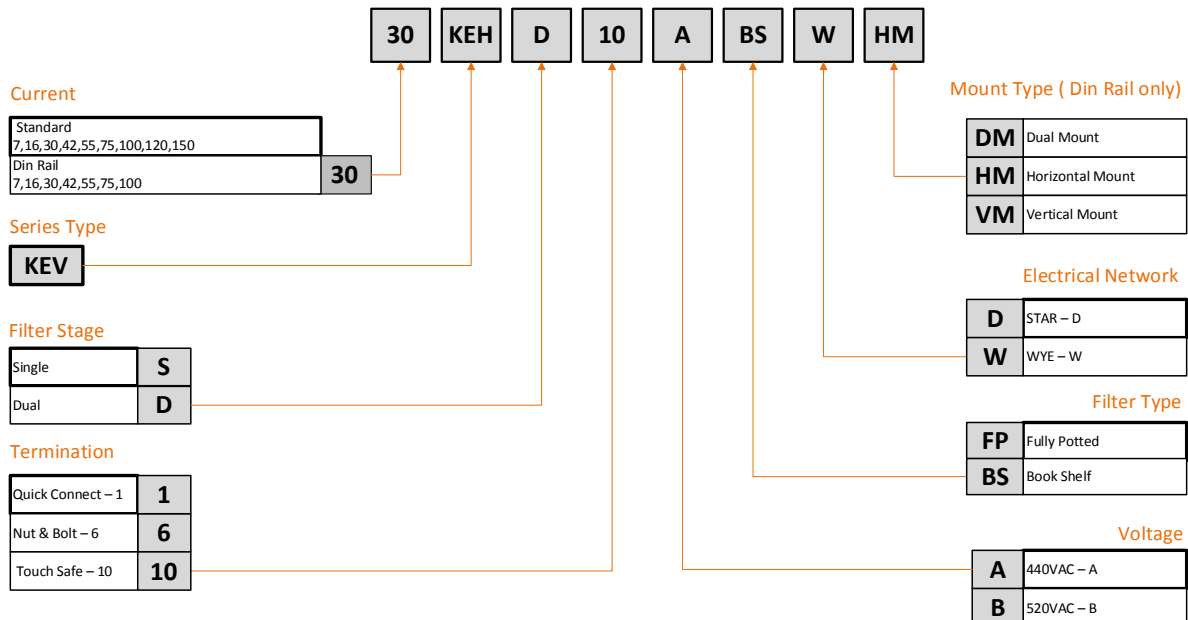

X-ON Electronics

Largest Supplier of Electrical and Electronic Components

Click to view similar products for [Power Line Filters](#) category:

Click to view products by [TE Connectivity](#) manufacturer:

Other Similar products are found below :

[6609019-3](#) [6609026-5](#) [6609030-6](#) [6609973-2](#) [D30A](#) [7-1609090-5](#) [F2810](#) [F4456A](#) [F7382Z](#) [F7863Z](#) [FAHAV3100ZC000](#) [806276](#) [FN2020B-1-06](#) [FN2080B-10-06](#) [FN2410H-32-33](#) [FN2410H-80-34](#) [FP144](#) [FS4153-20-06](#) [FS4353-500-99](#) [12-MMB-030-11-D](#) [DB4-393](#) [15811T200](#) [20B1](#) [LC630](#) [2B1](#) [1609080-2](#) [1609993-8](#) [1-6609070-1](#) [F1100AA02](#) [F1150CC10](#) [F1500CA10](#) [F1500CA15](#) [F4041Z](#) [F7585E](#) [1B1](#) [FN2070A-16-06](#) [FN2090A-20-06](#) [FN2090B-12-06](#) [FN2090Z-1-06](#) [FN2410H-25-33](#) [FN2410H-60-34](#) [FN2410H-8-44](#) [FN2412H-8-44](#) [FN323B-6-01](#) [FN3258H-130-35](#) [FN610R-3-06](#) [20EHQ7](#) [20EHZ7](#) [20K1](#) [30B6](#)