

Sin nuestra autorización, queda terminantemente prohibida la reproducción total o parcial de este documento, así como su uso indebido y/o su exhibición o comunicación a terceros. De los infractores se exigirá el correspondiente resarcimiento de daños y perjuicios. Se reserva todos los derechos para el caso de la concesión de patente de invención o el registro de Modelo Industrial.

Weitergabe sowie Vervielfältigung dieser Unterlage, Verwertung und Mitteilung ihres Inhalts sind nicht gestattet, soweit nicht ausdrücklich zugestanden. Zuwiderhandlungen verpflichten zu Schadenersatz. Alle Rechte für den Fall der Patenterteilung oder GM-Eintragung vorbehalten.

Copying of this document, and giving it to others and the use or communication of the contents thereof, are forbidden without express authority. Offenders are liable to the payment of damages. All rights are reserved in the event of the grant of a patent or the registration of a utility model or design.

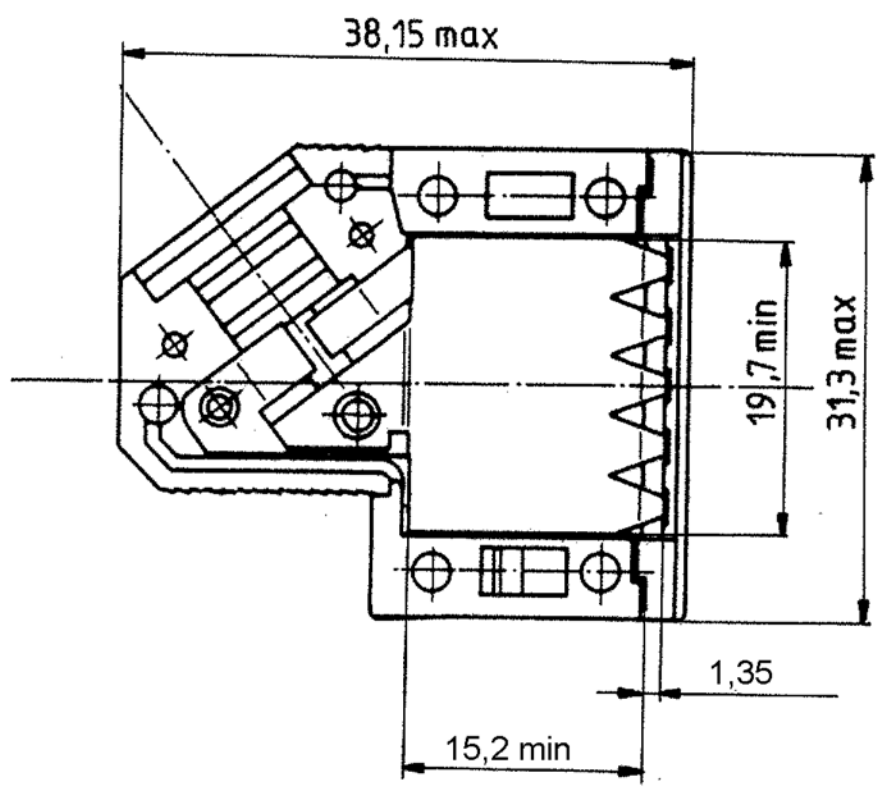

1 FOR PLASTIC PARTS (POS. 1 AND 2):  
 - LENGTHS: DIN 16901/130,  
 - ANGLES, FORMS: DIN 7168-m, R,  
 FOR METAL PARTS (POS. 3 AND 4): DIN 7168-m,  
 FOR SCREWS (POS. 5 AND 6): DIN 7981 F-H.

P/N 9 contacts version: V42254-A6000-G\*09

	Maßstab
	TE Connectivity
Datum: 30.08.88	D-Sub housing shielded 9 contacts
Bearb: De Petter	
Geor: PD Com P&SE	
Norm:	

C	ECO-12-008266	28AUG12	CWR
Zust	Mitteilung	Datum	Name

TOLERANCES UNLESS OTHERWISE SPECIFIED:  
 1  
 V42254-A6000-G\*\*\*-\*-27  
 customer drawing number: C 1393738-1  
 page 1+ of 6

Si esta versión autorizada, queda formalmente prohibida la reproducción total o parcial de este documento, así como su uso indebido y/o su exhibición o comunicación a terceros. De los infractores se exigirá el correspondiente resarcimiento de daños y perjuicios. Se reserva todos los derechos para el caso de la concesión de patente de invención o el registro de Modelo Industrial.



Weitergabe sowie Vervielfältigung dieses Unterbauelementes und Mitteilung ihres Inhalts ist nicht gestattet, soweit nicht ausdrücklich zugestanden. Zuwiderhandlung kann strafrechtliche Konsequenzen nach geltendem Recht nach sich ziehen. Alle Rechte vorbehalten. Alle Rechte vorbehalten.

Copying of this document and giving it to others and the use or communication of the contents thereof are forbidden without express authority. Offenders are liable to the payment of damages. All rights are reserved in the event of the grant of a patent or the registration of a utility model or design.

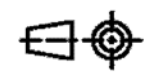

housing		dimension									
P/N	No. of contacts	A	B	C	D	E	F	G	H	J	K
V42254-A6000-											
G × 15	15					28	39,62		R3	14,5	R4,5
G × 25	25	13	14	1	7,5	41,8	53,52	6,5	R4	16	R5,5
G × 37	37					58,25	69,8				
G × 50	50	16	17,5	1,5	9,5	55,78	67,41	9,5	R5,5	20,6	R7

2) only for the 37 contacts version  
 1) tape only for the 15 to 37 contacts versions  
 drawn is the 25 contacts version

				Maßstab	
				TE Connectivity	
		Datum: 30.08.88 Bearb. De Petter Gepr. PD Com P&SE Norm.:		D-Sub housing shielded 15 to 50 contacts	
		TOLERANCES UNLESS OTHERWISE SPECIFIED:		<b>V42254-A6000-G***-*-27</b>	
		C SEE SHEET 1		page 2+	
		1		customer drawing number: C 1393738-1	
Zust.	Mitteilung	Datum	Name		

V 4 2 2 5 4 - A 6 0 0 \* - G \* \* \*

Housing type  
G plastic housing, shielded

Marking and colour of the housing

1	TE-marking, grey
2	without marking, grey
3	TE-marking, black
4	without marking, black

wire diameter	No. of contacts - housing size					
	0	1	2	3	4	
4-8					09	9 contact - housing size 1
5-10					15	15 contacts - housing size 2
5-11					25	25 contacts - housing size 3
6-11					37	37 contacts - housing size 4
9-14,5					50	50 contacts - housing size 5

  

Packaging	set 1)	200	2)	200	2)	200	2)	200	2)	200	2)

1) per set, in blister  
 - 9 and 15 contacts : 25  
 - 25, 37 and 50 contacts : 15  
 2) loose pieces, in cardboard : 200



TE Connectivity

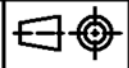

SCALE WEIGHT

LOC DIMENSIONS  
GW IN MM

MATERIAL

DATE 30.08.88

NAME D-Sub Housing

NAME De Petter

shielded

DEP. PD Com P&SE

EC

TOLERANCE UNLESS SPECIFIED OTHERWISE

DWG NO. SHT. 3+

SEE SHEET 1

V42254-A6000-G\*\*\*-\*-27

REV. CHANGE ORDER DATE APP. customer drawing number: C 1393738-1 OF 6

THIS INFORMATION IS CONFIDENTIAL AND PROPRIETARY TO TYCO ELECTRONICS CORPORATION AND ITS WORLDWIDE SUBSIDIARIES AND AFFILIATES. IT MAY NOT BE DISCLOSED TO ANYONE, OTHER THAN TYCO ELECTRONICS PERSONNEL, WITHOUT WRITTEN AUTHORIZATION FROM TYCO ELECTRONICS CORPORATION, HARRISBURG, PENNSYLVANIA USA.

PROPRIETARY:

A

B

C

D

E

F

Active part numbers. Contact Tyco Electronics for other configuration availability

Old Part Number	TE Part Number	
V42254-A6000-G109	1393738-1	
V42254-A6000-G115	1393738-2	
V42254-A6000-G125	1393738-3	
V42254-A6000-G137	1393738-4	
V42254-A6000-G150	1393738-5	
V42254-A6000-G209	<del>1393738-6</del>	OBSOLETE
V42254-A6000-G309	<del>1393738-7</del>	OBSOLETE
V42254-A6000-G315	<del>1393738-8</del>	OBSOLETE
V42254-A6000-G325	1393738-9	SUPERSEDED BY 1393738-1
V42254-A6001-G109	4-1393738-2	OBSOLETE
V42254-A6001-G125	4-1393738-4	SUPERSEDED BY 6-1393738-1
V42254-A6001-G309	4-1393738-5	SUPERSEDED BY 1-1393739-9
V42254-A6001-G315	4-1393738-6	SUPERSEDED BY 6-1393738-7
V42254-A6002-G109	5-1393738-0	OBSOLETE
V42254-A6002-G125	5-1393738-2	SUPERSEDED BY 6-1393738-1
V42254-A6003-G137	5-1393738-7	SUPERSEDED BY 6-1393738-2
V42254-A6004-G109	5-1393738-9	
V42254-A6004-G115	6-1393738-0	
V42254-A6004-G125	6-1393738-1	
V42254-A6004-G137	6-1393738-2	
V42254-A6004-G150	6-1393738-3	
V42254-A6004-G209	6-1393738-4	SUPERSEDED BY 5-1393738-9
V42254-A6004-G215	6-1393738-5	OBSOLETE
V42254-A6004-G225	6-1393738-6	OBSOLETE
V42254-A6004-G309	1-1393739-9	
V42254-A6004-G315	6-1393738-7	
V42254-A6004-G325	2-1393739-0	OBSOLETE
V42254-A6004-G337	2-1393739-1	SUPERSEDED BY 6-1393738-2
V42254-A6004-G350	2-1393739-2	SUPERSEDED BY 6-1393738-3
V42254-A6004-G409	6-1393738-8	OBSOLETE
V42254-A6004-G415	6-1393738-9	OBSOLETE
V42254-A6004-G437	7-1393738-1	OBSOLETE

THIS INFORMATION IS CONFIDENTIAL AND PROPRIETARY TO TYCO ELECTRONICS CORPORATION AND ITS WORLDWIDE SUBSIDIARIES AND AFFILIATES. IT MAY NOT BE DISCLOSED TO ANYONE, OTHER THAN TYCO ELECTRONICS PERSONNEL, WITHOUT WRITTEN AUTHORIZATION FROM TYCO ELECTRONICS CORPORATION, HARRISBURG, PENNSYLVANIA USA.

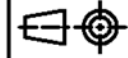

LOC DIMENSIONS  
GW IN MM

SCALE WEIGHT

MATERIAL

DATE 30.08.88  
NAME De Petter  
DEP. PD Com P&SE  
EC  
NAME D-Sub Housing  
shielded

TOLERANCE UNLESS SPECIFIED OTHERWISE  
DWG NO. V42254-A6000-G\*\*\*-\*-27  
SHT. 4+

REV.	CHANGE ORDER	DATE	APP.	Customer Drawing: C 1393738-1	OF 6
------	--------------	------	------	-------------------------------	------

PROPRIETARY:



PROPRIETARY: THIS INFORMATION IS CONFIDENTIAL AND PROPRIETARY TO TYCO ELECTRONICS CORPORATION AND ITS WORLDWIDE SUBSIDIARIES AND AFFILIATES. IT MAY NOT BE DISCLOSED TO ANYONE, OTHER THAN TYCO ELECTRONICS PERSONNEL, WITHOUT WRITTEN AUTHORIZATION FROM TYCO ELECTRONICS CORPORATION, HARRISBURG PENNSYLVANIA USA

V 4 2 2 5 4 - A 6 1 \* \* - L 1

Technical data		
	contact tube outer diameter ±0.1	for shield braiding outer diameter
04	4	2.0 to 2.7
05	5	2.8 to 3.7
06	6	3.8 to 4.7
07	7	4.8 to 5.7
08	8	5.8 to 6.7
09	9	6.8 to 7.7
10	10	7.8 to 8.7
11	11	8.8 to 9.7
12	12	9.8 to 10.7
13	13	10.8 to 11.7
14	14	11.8 to 12.7
15	15	12.8 to 13.7

Active part numbers. Contact Tyco Electronics for other configuration availability

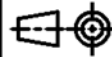
Old Part Number	TE Part Number	
V42254-A6104-L1	3-1393561-2	OBSOLETE
V42254-A6105-L1	3-1393561-3	
V42254-A6106-L1	3-1393561-4	
V42254-A6107-L1	3-1393561-5	
V42254-A6108-L1	3-1393561-6	
V42254-A6109-L1	3-1393561-9	
V42254-A6110-L1	4-1393561-0	
V42254-A6111-L1	<del>4-1393561-1</del>	OBSOLETE
V42254-A6112-L1	4-1393561-2	
V42254-A6113-L1	4-1393561-3	OBSOLETE
V42254-A6114-L1	4-1393561-4	OBSOLETE
V42254-A6115-L1	5-1393502-9	OBSOLETE

APPLICABLE SPEC.:				FINISH			
				DIMENSIONS APPLY		PLATING	
				SCALE		WEIGHT	
				MATERIAL			
				NAME			
DATE 30.08.88				D-Sub Housing			
NAME De Petter							
DEP. PD Com P&SE							
EC				accessories: contact tubes			
TOLERANCE UNLESS SPECIFIED OTHERWISE				DWG NO.		SHT. 5+	
V42254-A6000-G***-*-27				OF 6			
C	SEE SHEET 1	REV.	CHANGE ORDER	DATE	APP.	customer drawing number: C 1393738-1	



PROPRIETARY: THIS INFORMATION IS CONFIDENTIAL AND PROPRIETARY TO TYCO ELECTRONICS CORPORATION AND ITS WORLDWIDE SUBSIDIARIES AND AFFILIATES. IT MAY NOT BE DISCLOSED TO ANYONE, OTHER THAN TYCO ELECTRONICS PERSONNEL, WITHOUT WRITTEN AUTHORIZATION FROM TYCO ELECTRONICS CORPORATION, HARRISBURG PENNSYLVANIA USA

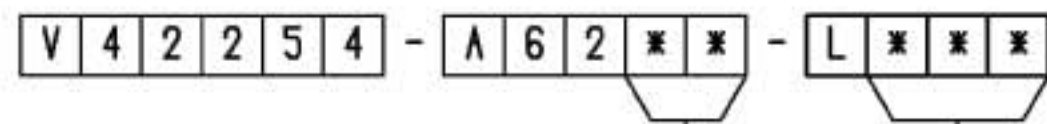

		Technical Data	
		bushing inner diameter ±0.2	cable outer diameter
00	1)2)	/	/
05	3)	5	4.2 to 4.9
06	3)	6	5.0 to 5.9
07	3)	7	6.0 to 6.9
08	3)	8	7.0 to 7.9
09	3)	9	8.0 to 8.9
10	2)	10	9.0 to 9.9
11	2)	11	10.0 to 10.9
12	4)	12	11.0 to 11.9
13	4)	13	12.0 to 12.9
14	4)	14	13.0 to 13.9
15	4)	15	14.0 to 14.9

	contacts	colour
1	9 to 37	grey
50	50	grey
100	9 to 37	black
150	50	black

Active part numbers. Contact Tyco Electronics for other configuration availability

Old Part Number	TE Part Number	
V42254-A6200-L 1	4-1393561-5	OBSOLETE
V42254-A6200-L 50	4-1393561-6	
V42254-A6200-L100	5-1393502-1	OBSOLETE
V42254-A6200-L150	5-1393502-2	OBSOLETE
V42254-A6205-L 1	4-1393561-7	
V42254-A6205-L100	4-1393561-8	
V42254-A6206-L 1	4-1393561-9	
V42254-A6206-L100	5-1393561-0	
V42254-A6207-L 1	5-1393561-1	
V42254-A6207-L100	5-1393561-4	OBSOLETE
V42254-A6208-L 1	5-1393561-5	
V42254-A6208-L100	5-1393561-6	OBSOLETE
V42254-A6209-L 1	5-1393561-7	
V42254-A6209-L100	5-1393561-8	
V42254-A6210-L 1	5-1393561-9	
V42254-A6210-L 50	6-1393561-0	OBSOLETE
V42254-A6210-L100	6-1393561-1	OBSOLETE
V42254-A6210-L150	5-1393502-3	OBSOLETE
V42254-A6211-L 1	6-1393561-2	
V42254-A6211-L 50	6-1393561-3	OBSOLETE
V42254-A6211-L100	5-1393502-4	OBSOLETE
V42254-A6211-L150	5-1393502-5	OBSOLETE
V42254-A6212-L 50	6-1393561-4	OBSOLETE
V42254-A6212-L150	5-1393502-6	OBSOLETE
V42254-A6213-L 50	6-1393561-5	OBSOLETE
V42254-A6213-L150	5-1393502-7	OBSOLETE
V42254-A6214-L 50	6-1393561-6	OBSOLETE
V42254-A6214-L150	5-1393502-8	OBSOLETE
V42254-A6215-L 50	8-1393501-5	OBSOLETE
V42254-A6215-L150	6-1393561-7	OBSOLETE

- 4) only for 50 contacts
- 3) only for 9 to 37 contacts
- 2) for 9 to 50 contacts
- 1) Blank bushing

APPLICABLE SPEC.				FINISH			
				DIMENSIONS APPLY		PLATING	
				SCALE		WEIGHT	
				MATERIAL			
DATE: 30.08.88 NAME: De Petter DEP.: PD Com P&SE EC				NAME: D-Sub Housing			
TOLERANCE UNLESS SPECIFIED OTHERWISE				accessories: cable bushings			
c SEE SHEET 1 REV. CHANGE ORDER				DWG NO. V42254-A6000-G***-*-27 SHT. 6 OF 6			
DATE				customer drawing number: C 1393738-1			

## X-ON Electronics

Largest Supplier of Electrical and Electronic Components

*Click to view similar products for [D-Sub Backshells](#) category:*

*Click to view products by [TE Connectivity](#) manufacturer:*

Other Similar products are found below :

[173114-0084](#) [173112-1658](#) [600X51137X](#) [600X54009X](#) [66241-12A](#) [M85049/48-1-2](#) [M85049/48-3-5F](#) [M85049/6-38N](#) [M85049/86-12N03](#)  
[70.350.2435.1](#) [72.350.1035.2](#) [72.352.2435.1](#) [73.359.4035.3](#) [799-015TMH07M](#) [799-015TMH08N](#) [FKH1RE](#) [829472-1](#) [F-PHG-1E](#) [F-PHG-3E](#)  
[F-PHG-4E](#) [F-PHR-4E](#) [PCS-E20W](#) [8655MHRA0901KLF](#) [8655MHRA2501KLF](#) [958-009-010R011](#) [970-015-040R011](#) [970-025-040R011](#)  
[971-009-030R121](#) [971-009-040R011](#) [971-015-040R011](#) [971-025-040R011](#) [GS85049/38-25M](#) [975T009-020R121](#) [975T015-020R121](#) [1-](#)  
[21986-2](#) [1-21986-5](#) [DB-20962](#) [DB-C4-J11](#) [DE-C8-J9-F4-1R](#) [DE-C8-J9-F5-1R](#) [DPH-B-003](#) [1437013-9](#) [1484402-8](#) [MS3057-10A](#) [156-3025-](#)  
[EX](#) [MS3417-16C](#) [16-500800](#) [165X02659X](#) [165X03399A](#) [165X10139X](#)