

NUMBER C-173985

METRIC 三角法 (3rd ANGLE PROJECTION)

METRIC

単位: 概 DIMENSIONS IN MM. DO NOT SCALE PRINT

PRINT DIST

4

3

2

1

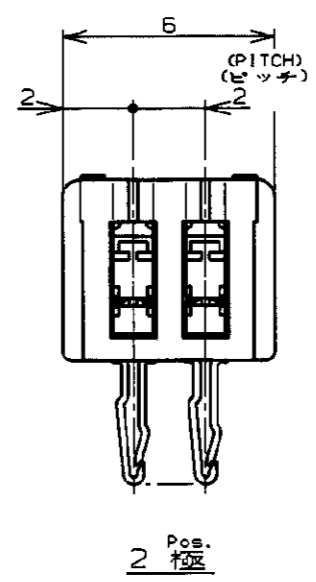
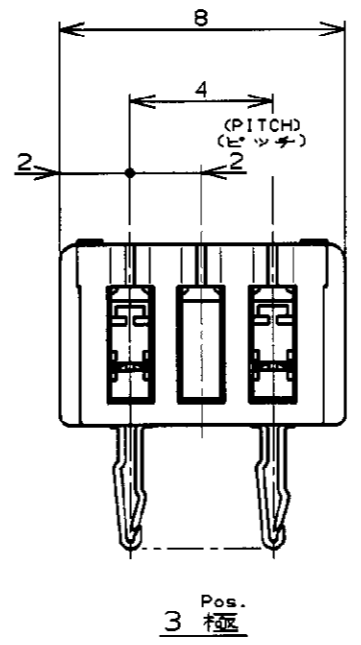
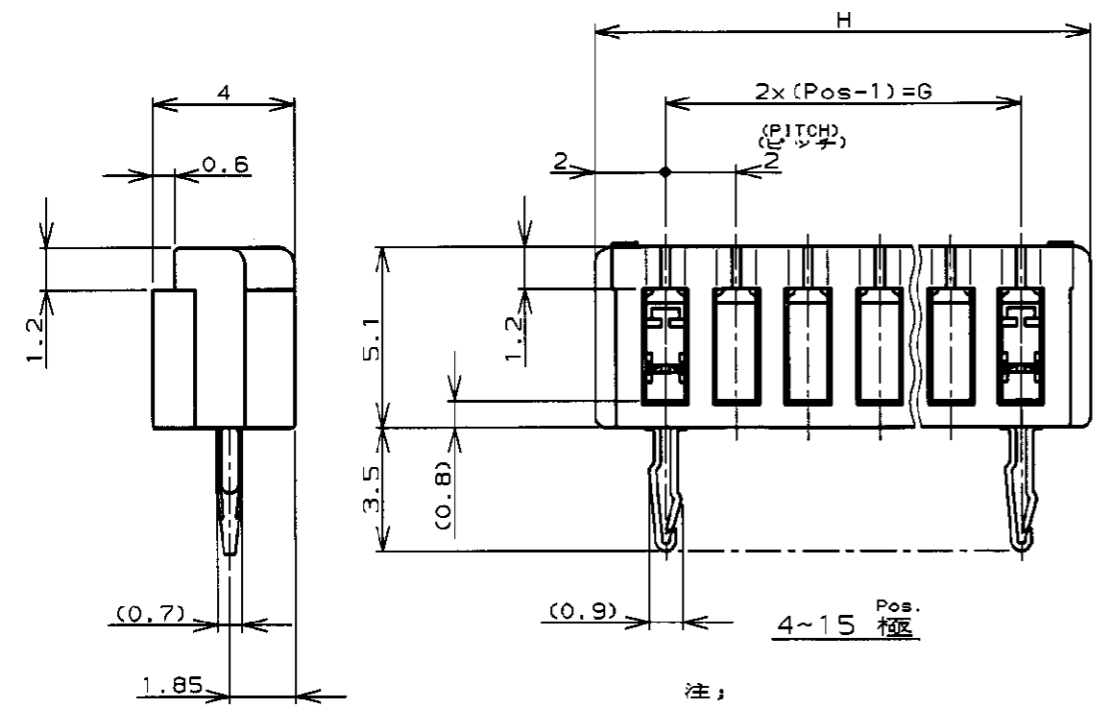
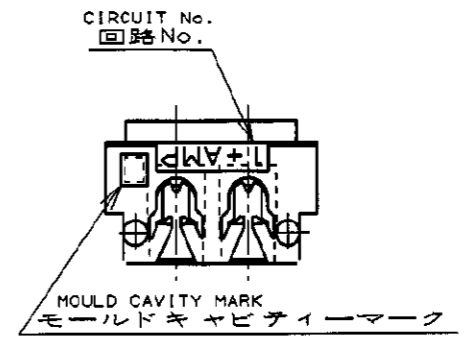
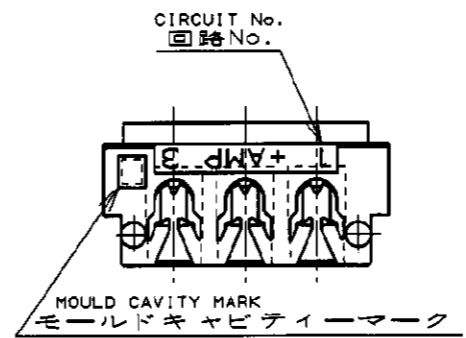
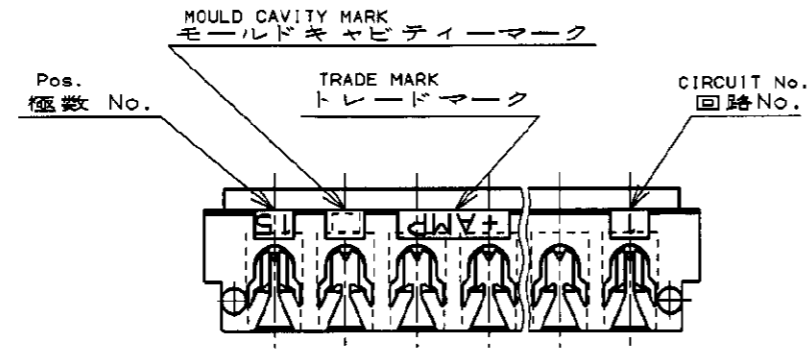

- 注;
1. 適用電線範囲 : AWG #28~26 (UL1571, UL1061)
被覆外径 : 0.83~10.5
(但し、使用電線について適合性に確認が必要です。)
 2. 材料 : ハウジング : ガラス入りP.B.T UL94V-0
コンタクト : 錫めっき済磷青銅
 3. 適用製品規格番号 : 108-5217
 4. 取付適用規格番号 : 114-5103

- NOTES;
1. APPLICABLE WIRE SIZE : AWG #28~26 (UL1571, UL1061)
INSULATION DIA RANGE : 0.83~1.05
 2. MATERIAL :
HOUSING : P.B.T. (G.F)UL94V-0
CONTACT : PRE-TIN PHOS BRONZE
 3. PRODUCT SPEC : 108-5217
 4. APPLICATION SPEC : 114-5103

3-173985-5	15	28	32
3-	-4	14	26 30
3-	-3	13	24 28
3-	-2	12	22 26
3-	-1	11	20 24
3-	-0	10	18 22
2-	-9	9	16 20
2-	-8	8	14 18
2-	-7	7	12 16
2-	-6	6	10 14
2-	-5	5	8 12
2-	-4	4	6 10
2-	-3	3	AS SHOWN 図示
2-173985-2	2	AS SHOWN 図示	
LIGHT BULE ライトブルー	Pos. 極数	G	H
PART No. 製品型番			

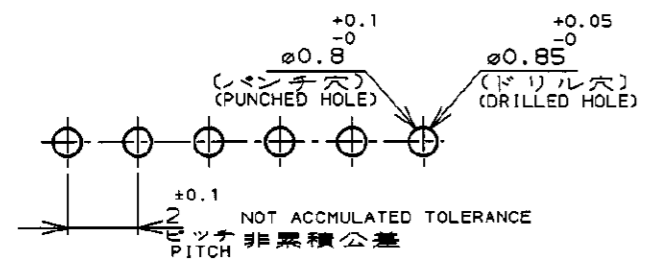

RECOMMENDABLE P.C. BOARD LAYOUT
推奨基板穴寸法
(適用基板厚0.8~1.6)
(P.C.B THK:0.8~1.6)

F1	REVISED PER ECO-11-005033	RK	HMR	2APR11
LTR	変更 (REVISION RECORD)	DR	CHK	DATE

TE Connectivity		
組合電線断面積 (WIRE RANGE) NOTE 1 mm ² (AWG -)	被覆外径 (INSULATION DIA.) NOTE 1 mmφ	名称 (NAME) CT AMP-IN HEADER 2mm PITCH MT VERTICAL (V-TYPE)
材料 (MATERIAL) NOTE 2	仕上 (FINISH)	一般公差 (GENERAL TOLERANCE) 10以下 : ±0.2 10を超え 30以下 : ±0.25 30を超え 100以下 : ±0.3 角 度 : ±3°
DR. 23/AUG/'99 J. TSUJI	DE. 23/AUG/'99 	LOC 番号 (No.) B J C-173985
APP. 23/AUG/'99 	REV. F1	SHEET 1 OF 1

X-ON Electronics

Largest Supplier of Electrical and Electronic Components

Click to view similar products for [Headers & Wire Housings](#) category:

Click to view products by [TE Connectivity](#) manufacturer:

Other Similar products are found below :

[95000-104TRLF](#) [10135584-644402LF](#) [DF62W-EP2022PCA](#) [95000-106TRLF](#) [DF62W-2022SCA](#) [DF62W-EP2022PC](#) [2203348](#) [DF62W-2022SC](#) [1084018](#) [1029039](#) [1084017](#) [802-10-012-10-002000](#) [1112640](#) [1112639](#) [000-34000](#) [0009482033](#) [0009507031](#) [57102-S06-03LF](#) [57202-S52-04LF](#) [PCN6-15S-2.5E](#) [0039019024](#) [58102-G61-06LF](#) [582553-1](#) [0009508121](#) [0050291907](#) [018731A](#) [LY20-4P-DT1-P1E-BR](#) [02.125.8002.8](#) [60101931](#) [60598-1 \(Cut Strip\)](#) [M1625-3R/100](#) [61062-3](#) [61082-181009](#) [636-1427](#) [638009-1](#) [641938-9](#) [641991-4](#) [644168-1](#) [647662-1](#) [65039-019ELF](#) [65817-002LF](#) [65817-015LF](#) [65863-015LF](#) [66207-023LF](#) [67016-026LF](#) [67046-001LF](#) [67095-007LF](#) [68002-116](#) [68016-236H](#) [68648-049](#)