

THIS DRAWING IS UNPUBLISHED. RELEASED FOR PUBLICATION 20
 © COPYRIGHT 20 BY Tyco Electronics Japan G.K. ALL RIGHTS RESERVED.

LOC	DIST	REVISIONS					
J	-	P	LTR	DESCRIPTION	DATE	DWN	APVD
			E	REVISED	14JUN2011	M.M	N.Y
			E1	REVISED PER ECR-17-007048	16MAY2017	N.W	C.W

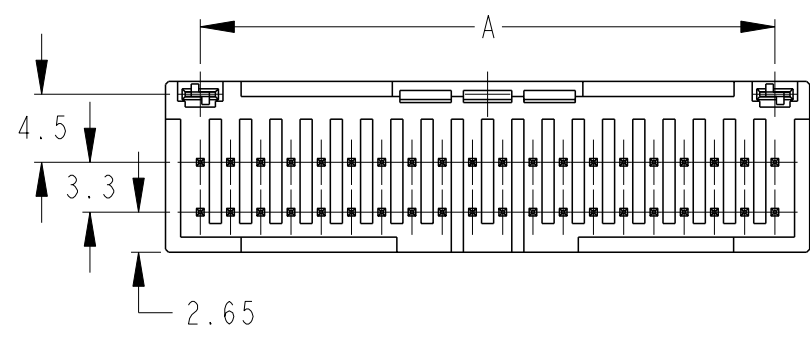
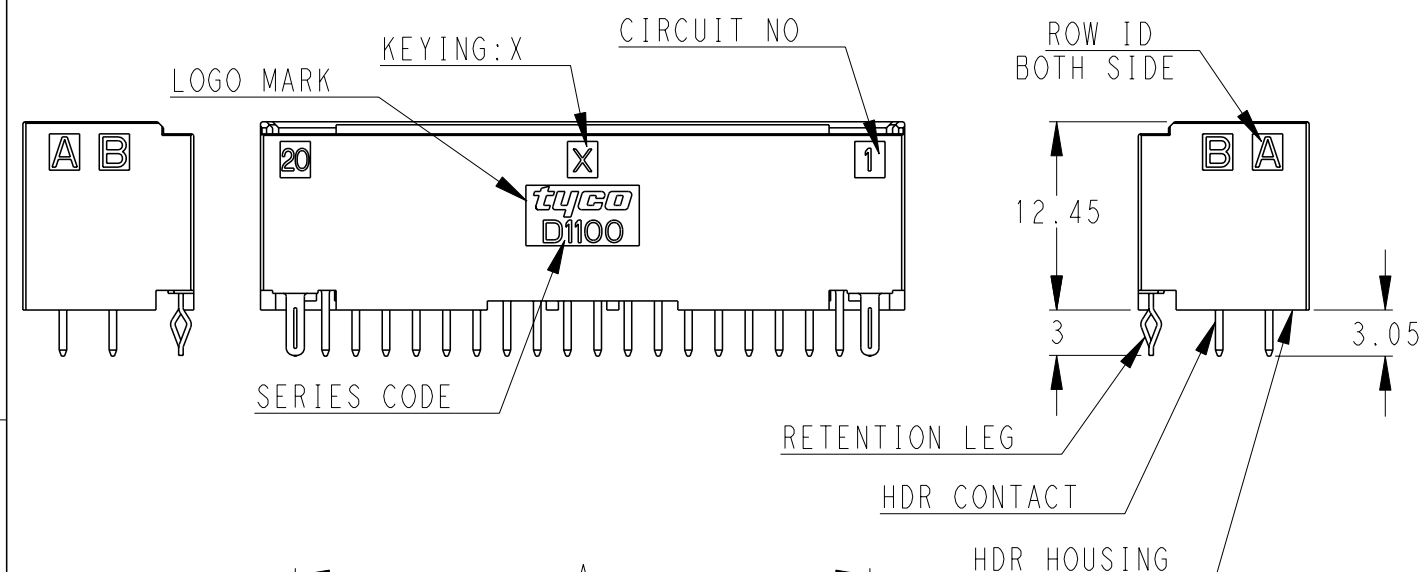
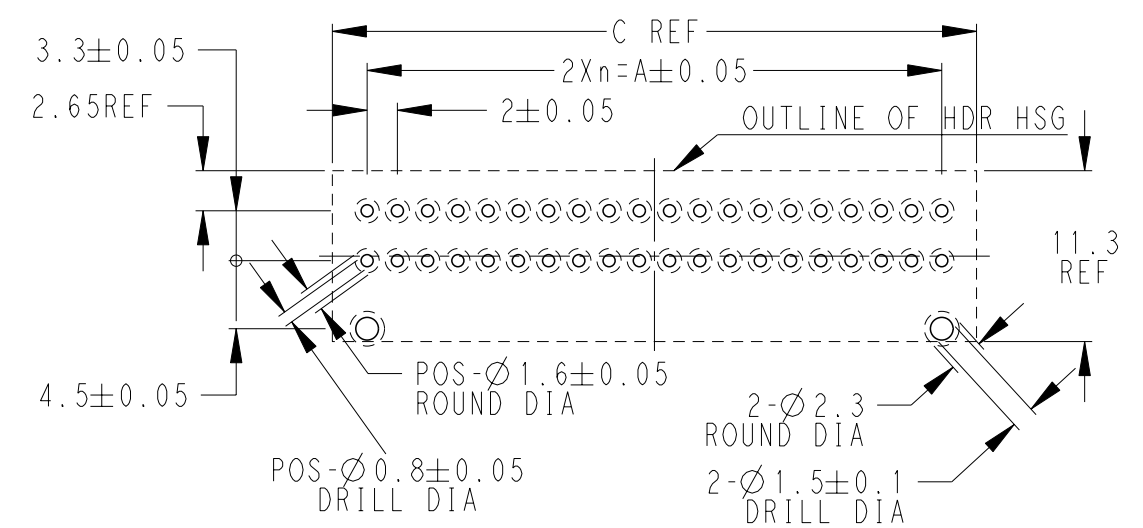
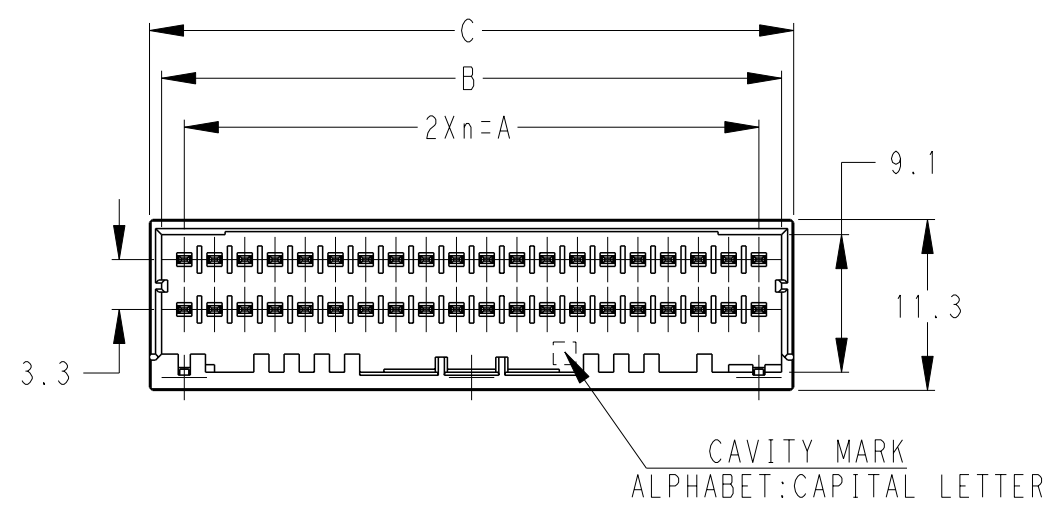

RECOMMEND PC BOARD HOLE PATTERN
 : CONNECTOR MOUNT SIDE (NOT ACCUMULATE TOLERANCE)
 PC BOARD THICKNESS : 1.0~1.6±0.1

- 1-1871056-□ : NATURAL (X-KEY) PRE-TIN
- 3-1871056-□ : YELLOW (X-KEY) PRE-TIN
- 5-1871056-□ : RED (X-KEY) PRE-TIN
- 6-1871056-□ : BLACK (X-KEY) TIN PLATED

POS	KEY	n	A	B	C	COLOR	PART NO
40	X	19	38.0	41.0	42.6	BLACK	6-1871056-0
40	X	19	38.0	41.0	42.6	RED	5-1871056-0
40	X	19	38.0	41.0	42.6	YELLOW	3-1871056-0
40	X	19	38.0	41.0	42.6	NATURAL	1-1871056-0
34	X	16	32.0	35.0	36.6	BLACK	6-1871056-7
32	X	15	30.0	33.0	34.6	BLACK	6-1871056-6
32	X	15	30.0	33.0	34.6	NATURAL	1-1871056-6
30	X	14	28.0	31.0	32.6	BLACK	6-1871056-5
30	X	14	28.0	31.0	32.6	YELLOW	3-1871056-5
30	X	14	28.0	31.0	32.6	NATURAL	1-1871056-5
28	X	13	26.0	29.0	30.6	BLACK	6-1871056-4
28	X	13	26.0	29.0	30.6	RED	5-1871056-4
26	X	12	24.0	27.0	28.6	BLACK	6-1871056-3
26	X	12	24.0	27.0	28.6	NATURAL	1-1871056-3
24	X	11	22.0	25.0	26.6	BLACK	6-1871056-2
24	X	11	22.0	25.0	26.6	YELLOW	3-1871056-2
22	X	10	20.0	23.0	24.6	BLACK	6-1871056-1
22	X	10	20.0	23.0	24.6	YELLOW	3-1871056-1
POS	KEY	n	A	B	C	COLOR	PART NO

1 MATERIAL:
 HOUSING : GLASS FILLED THERMO PLASTIC
 POLYESTER(94V-0), COLOR:EXCLUDING BLACK
 CONTACT : PRE-TIN COPPER ALLOY, OR TIN PLATED ON COPPER ALLOY
 RETENTION LEG : PRE-TIN COPPER ALLOY

- 40POS(X-KEY):
 1-1871056-0(NATURAL)
 3-1871056-0(YELLOW)
 5-1871056-0(RED)

THIS DRAWING IS A CONTROLLED DOCUMENT.		DWN T. KUDO 21APR2005	TE Connectivity NAME DYNAMIC 1100D 2.0mmPITCH HDR ASSY (V-TYPE) TIN PLATE-COLOR 22-40POS				
DIMENSIONS: mm		CHK D. MITSUGI 23AUG2005					
TOLERANCES UNLESS OTHERWISE SPECIFIED: ±0.3, ±5°		APVD D. MITSUGI 23AUG2005					
0-PLC ± 1-PLC ±0.1 2-PLC ±0.01 3-PLC ±0.001 4-PLC ±0.0001 ANGLES ±		PRODUCT SPEC 108-78298					
MATERIAL 1		FINISH -	APPLICATION SPEC 114-5377	SIZE A3	CAGE CODE 00779	DRAWING NO C-1871056	RESTRICTED TO -
CUSTOMER DRAWING			WEIGHT -	SCALE 2:1	SHEET 1	OF 3	REV E1

THIS DRAWING IS UNPUBLISHED.

RELEASED FOR PUBLICATION

20

© COPYRIGHT 20

BY Tyco Electronics Japan G.K.

ALL RIGHTS RESERVED.

LOC	DIST	REVISIONS					
		P	LTR	DESCRIPTION	DATE	DWN	APVD
J	-			SEE SHEET 1 OF 3			

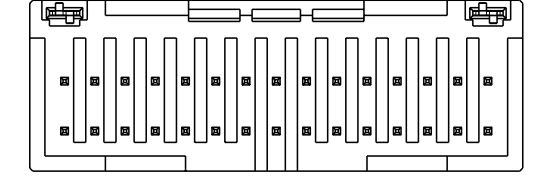
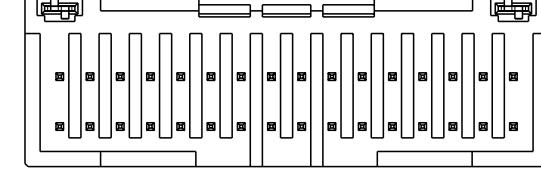
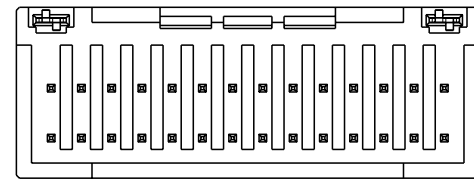
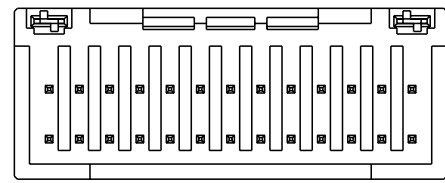
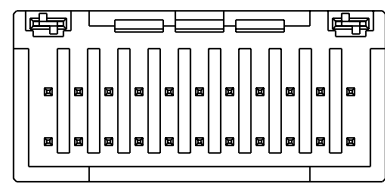
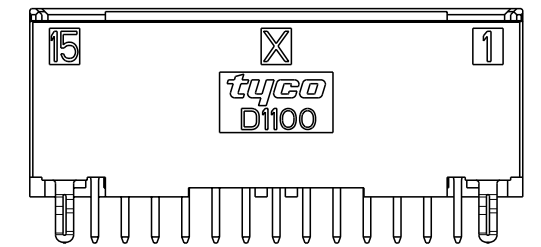
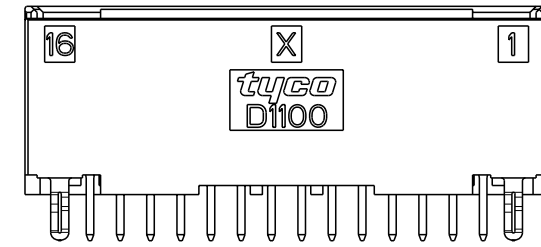
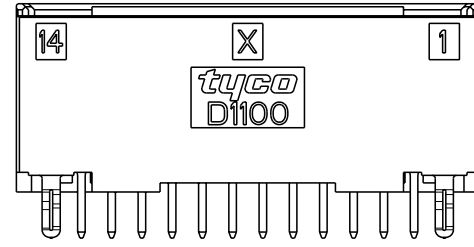
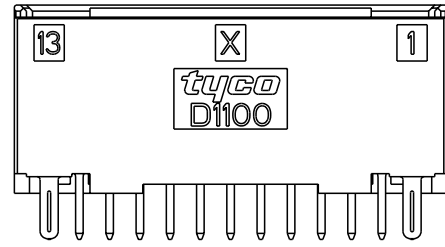
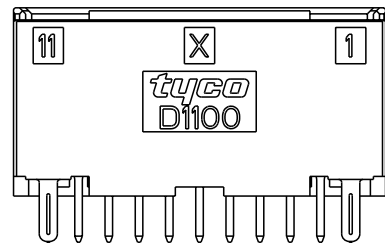
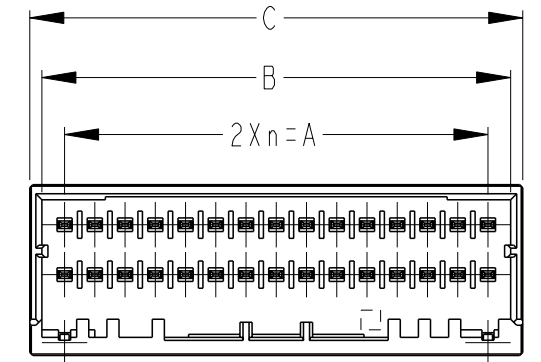
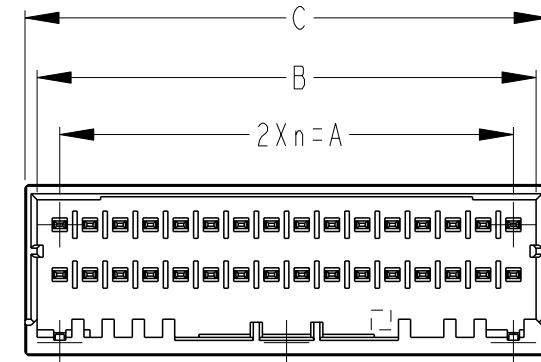
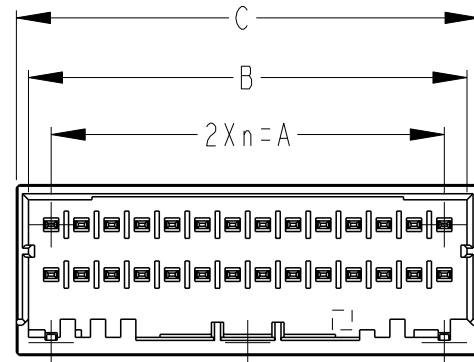
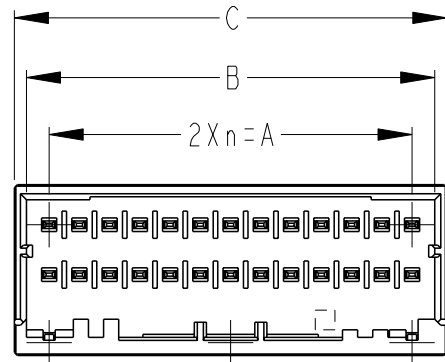
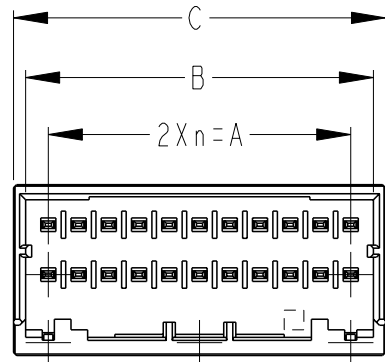

22POS(X-KEY):
3-1871056-1(YELLOW)

26POS(X-KEY):
1-1871056-3(NATURAL)

28POS(X-KEY):
5-1871056-4(RED)

32POS(X-KEY):
1-1871056-6(NATURAL)

30POS(X-KEY):
1-1871056-5(NATURAL)
3-1871056-5(YELLOW)

THIS DRAWING IS A CONTROLLED DOCUMENT.		DWN T. KUDO 21APR2005	TE Connectivity	
DIMENSIONS: mm		CHK D. MITSUGI 23AUG2005		
TOLERANCES UNLESS OTHERWISE SPECIFIED:		APVD D. MITSUGI 23AUG2005	NAME DYNAMIC 1100D 2.0mmPITCH HDR ASSY (V-TYPE) TIN PLATE-COLOR 22-40POS	
0 PLC ± 1 PLC ± 2 PLC ± 3 PLC ± 4 PLC ± ANGLES ±		PRODUCT SPEC 108-78298	RESTRICTED TO	
MATERIAL		APPLICATION SPEC 114-5377	SIZE A3	CAGE CODE 00779
FINISH		WEIGHT	DRAWING NO C=1871056	
		CUSTOMER DRAWING	SCALE 2:1	SHEET 2 OF 3
			REV E1	

SEE SHEET 1 OF 3

THIS DRAWING IS UNPUBLISHED.

RELEASED FOR PUBLICATION

20

© COPYRIGHT 20

BY Tyco Electronics Japan G.K.

ALL RIGHTS RESERVED.

LOC

DIST

REVISIONS

J

-

P

LTR

DESCRIPTION

DATE

DWN

APVD

SEE SHEET 1 OF 3

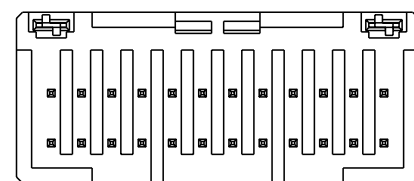
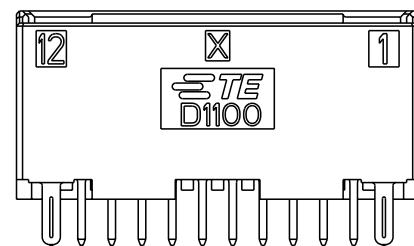
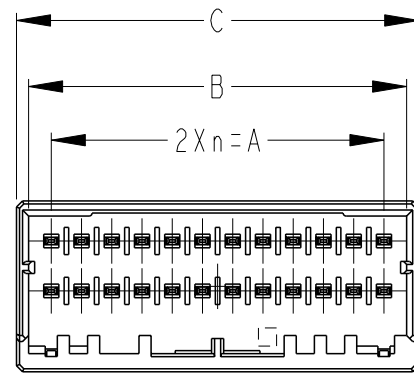

24POS(X-KEY):
3-1871056-2(YELLOW)

THIS DRAWING IS A CONTROLLED DOCUMENT.

DIMENSIONS:
mm

TOLERANCES UNLESS
OTHERWISE SPECIFIED:

- 0 PLC ±
- 1 PLC ±
- 2 PLC ±
- 3 PLC ±
- 4 PLC ±
- ANGLES ±

MATERIAL

FINISH

DWN T. KUDO 21APR2005

CHK D. MITSUGI 23AUG2005

APVD D. MITSUGI 23AUG2005

PRODUCT SPEC
108-78298

APPLICATION SPEC
114-5377

WEIGHT -

TE TE Connectivity

NAME
DYNAMIC 1100D 2.0mmPITCH
HDR ASSY (V-TYPE)
TIN PLATE-COLOR 22-40POS

SIZE CAGE CODE DRAWING NO RESTRICTED TO

A3 00779 C-1871056

CUSTOMER DRAWING

SCALE 2:1

SHEET 3 OF 3

REV E1

SEE SHEET 1 OF 3

X-ON Electronics

Largest Supplier of Electrical and Electronic Components

Click to view similar products for [Headers & Wire Housings](#) category:

Click to view products by [TE Connectivity](#) manufacturer:

Other Similar products are found below :

[892-18-020-10-001101](#) [58102-G61-06LF](#) [582553-1](#) [0009485154](#) [009176003701906](#) [0050291907](#) [LY20-4P-DT1-P1E-BR](#) [02.125.8002.8](#)
[609-3404](#) [61062-3](#) [61082-181009](#) [622-3653LF](#) [63453-116](#) [636-1030](#) [636-1427](#) [636-3427](#) [636-4007](#) [641938-9](#) [641991-4](#) [644827-2](#) [65817-](#)
[010LF](#) [65817-015LF](#) [65863-015LF](#) [66207-023LF](#) [67095-007LF](#) [67601157](#) [68645-018](#) [68648-049](#) [70.362.1628.0](#) [70-4210](#) [70-4226B](#) [70-](#)
[4853B](#) [707-5020](#) [707-5028](#) [71.350.2428.0](#) [71918-208LF](#) [71961-016LF](#) [733-134](#) [733-162](#) [754199-000](#) [760-3052](#) [79531-3000](#) [FCN-](#)
[360C032-B](#) [FCN-367T-T012/H](#) [FCN-723D010/2](#) [80.063.4001.1](#) [800-90-010-10-002000](#) [801-43-002-10-013000](#) [801-43-006-10-002000](#)
[801-93-011-10-001000](#)