

THIS DRAWING IS UNPUBLISHED.

RELEASED FOR PUBLICATION

© COPYRIGHT - BY - TE CONNECTIVITY

ALL RIGHTS RESERVED.

LOC - -

DIST - -

REVISIONS

P	LTR	DESCRIPTION	DATE	DWN	APVD
F		ECR-15-007519	19AUG2015	A.Q	D.Z
G		ECR-15-015566	19OCT2015	A.Q	D.Z
GI		ECR-17-017050	23NOV2017	C.X	D.Z

(2 POS.)

(6 POS.)

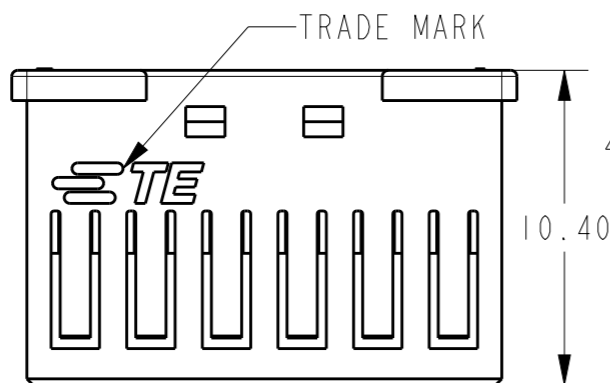
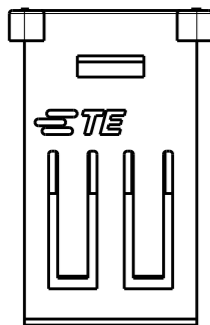

Notes:  
 1 GENERAL TOLERANCE  $\pm 0.3, \pm 3^\circ$   
 2 MATERIAL: PA66 GF(UL94V-0)  
 3 6-1971793-1 AS SHOWN ARE ONLY FOR P/N IN TABLE I  
 4 APPLICABLE CONTACT P/N: 1971795-1  
 5 RESTRICTED TO SPECIAL CUSTOMER (HAIER)

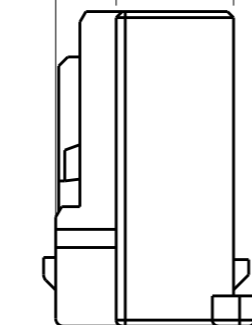
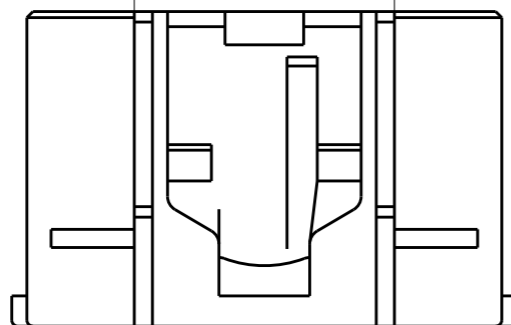
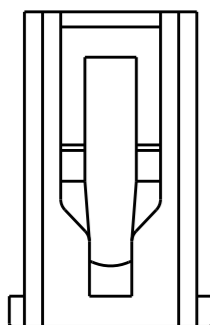
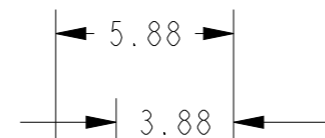
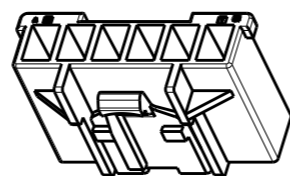
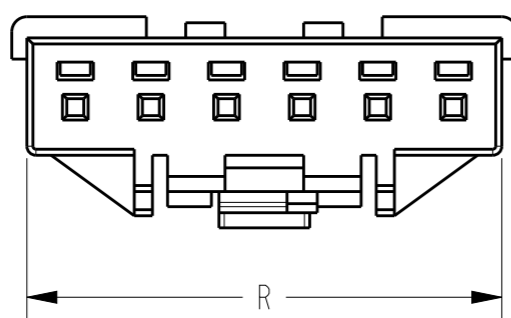
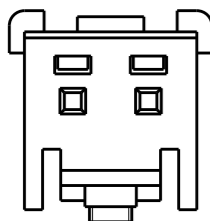

MATING CONN P/N	COLOR	KEYING	R	M	P	N(POS.)	P/N
3-1971798-4	YELLOW	D	8.2	5	6.2	3	3-2232701-4
3-1971798-2	BLUE	B					3-2232701-2
2-1971798-1	NATURAL	A	5.7	2.5	5.7	2	2-2232701-1
6-1971798-X 6-1971800-X	NATURAL	NA	15.7	12.5	8.6	6	6-1971793-6
	BLACK	D					6-1971793-5
	YELLOW	D					6-1971793-4
	RED	C					6-1971793-3
	BLUE	B					6-1971793-2
5-1971798-X 5-1971800-X	NATURAL	A	13.2	10	8.6	5	5-1971793-5
	BLACK	D					5-1971793-4
	YELLOW	D					5-1971793-3
	RED	C					5-1971793-2
	BLUE	B					5-1971793-1
4-1971798-X 4-1971800-X	NATURAL	A	10.7	7.5	7.4	4	4-1971793-5
	BLACK	D					4-1971793-4
	YELLOW	D					4-1971793-3
	RED	C					4-1971793-2
	BLUE	B					4-1971793-1
3-1971798-X 3-1971800-X	NATURAL	A	8.2	5	6.2	3	3-1971793-5
	BLACK	D					3-1971793-4
	YELLOW	D					3-1971793-3
	RED	C					3-1971793-2
	BLUE	B					3-1971793-1
2-1971798-X 2-1971800-X	NATURAL	A	5.7	2.5	5.7	2	2-1971793-5
	BLACK	D					2-1971793-4
	YELLOW	D					2-1971793-3
	RED	C					2-1971793-2
	BLUE	B					2-1971793-1

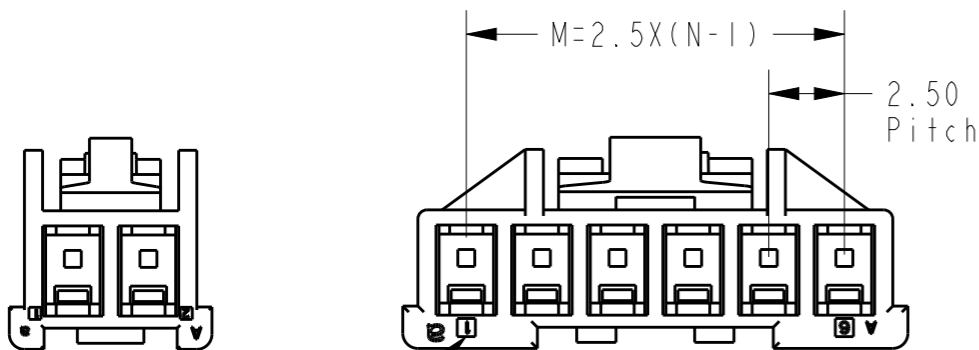

CIRCUIT NO. 1

THIS DRAWING IS A CONTROLLED DOCUMENT.

DIMENSIONS: mm

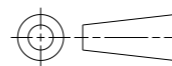

TOLERANCES UNLESS OTHERWISE SPECIFIED:

- 0 PLC  $\pm 0.3$
- 1 PLC  $\pm 0.3$
- 2 PLC  $\pm 0.13$
- 3 PLC  $\pm 0.013$
- 4 PLC  $\pm 0.000J$
- ANGLES  $\pm 3$

MATERIAL SEE NOTE

FINISH -

DWN HJ.Z 28MAY2013

CHK HJ.Z 28MAY2013

APVD YH.M 28MAY2013

PRODUCT SPEC 108-106077

APPLICATION SPEC 114-106077

WEIGHT -

Customer Drawing



NAME NEXT GENERATION GRACE INERTIA CONNECTOR 2.5 PLUG HOUSING

SIZE A3 CAGE CODE - DRAWING NO. C-1971793 RESTRICTED TO -

SCALE 5:1 SHEET 1 OF 3 REV GI

4

3

2

1

THIS DRAWING IS UNPUBLISHED.

RELEASED FOR PUBLICATION

20

© COPYRIGHT 20

BY -

ALL RIGHTS RESERVED.

LOC -

DIST -

REVISIONS

P	LTR	DESCRIPTION	DATE	DWN	APVD
-	-	SEE SHEET 1	-	-	-

7-1971793-1 AS SHOWN FOR P/N IN TABLE 2

Notes:  
 1 DIMENSIONS SHOWING IN SHEET 2 ARE ONLY FOR P/N IN TABLE 2  
 2 DIMENSIONS NOT SHOWING IN SHEET 2 ARE THE SAME WITH DIMENSIONS IN SHEET 1

TABLE 2							
8-1971798-X 8-1971800-X	BLACK	D	20.7	17.5	10.2	8	8-1971793-5
	YELLOW	D					8-1971793-4
	RED	C					8-1971793-3
	BLUE	B					8-1971793-2
	NATURAL	A					8-1971793-1
7-1971798-X 7-1971800-X	BLACK	D	18.2	15	10.2	7	7-1971793-5
	YELLOW	D					7-1971793-4
	RED	C					7-1971793-3
	BLUE	B					7-1971793-2
	NATURAL	A					7-1971793-1
MATING CONN P/N	COLOR	KEYING	R	M	P	N(POS.)	P/N

THIS DRAWING IS A CONTROLLED DOCUMENT.		DWN ANNIE QIAN 08MAY2015														
DIMENSIONS: mm		CHK ANNIE QIAN 08MAY2015														
TOLERANCES UNLESS OTHERWISE SPECIFIED		APVD DANIEL AHGN 08MAY2015	NAME NEXT GENERATION GRACE INERTIA CONNECTOR 2.5 PLUG HOUSING													
<table border="1"> <tr> <td>0 PLC</td> <td>±</td> </tr> <tr> <td>1 PLC</td> <td>±0.3</td> </tr> <tr> <td>2 PLC</td> <td>±0.13</td> </tr> <tr> <td>3 PLC</td> <td>±0.013</td> </tr> <tr> <td>4 PLC</td> <td>±0.000J</td> </tr> <tr> <td>ANGLES</td> <td>±3</td> </tr> </table>		0 PLC	±	1 PLC	±0.3	2 PLC	±0.13	3 PLC	±0.013	4 PLC	±0.000J	ANGLES	±3	PRODUCT SPEC 108-106077	SIZE A3	CAGE CODE -
0 PLC	±															
1 PLC	±0.3															
2 PLC	±0.13															
3 PLC	±0.013															
4 PLC	±0.000J															
ANGLES	±3															
MATERIAL -		FINISH -	APPLICATION SPEC 114-106077	DRAWING NO C-1971793												
		WEIGHT -	RESTRICTED TO -													
CUSTOMER DRAWING			SCALE 5:1	SHEET 2 OF 3												
			REV G1													

1470-19 (3/11)

THIS DRAWING IS UNPUBLISHED.

RELEASED FOR PUBLICATION

20

© COPYRIGHT 20 BY -

ALL RIGHTS RESERVED.

LOC -

DIST -

REVISIONS

P	LTR	DESCRIPTION	DATE	DWN	APVD
-	-	SEE SHEET 1	-	-	-

KEY A

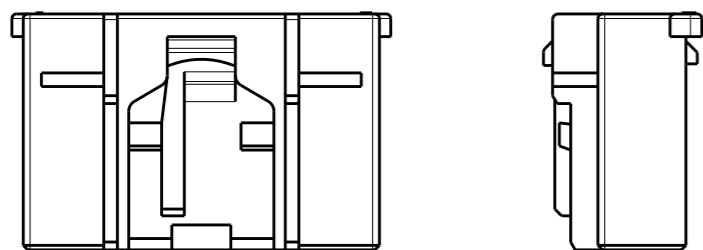

KEY B

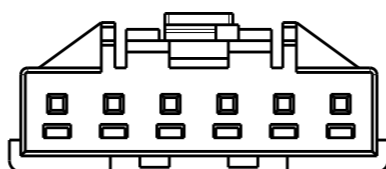
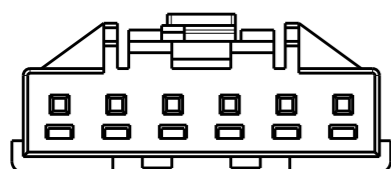
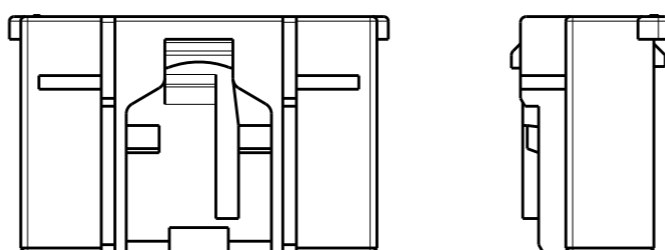

FOR 6-1971793-6 NO KEY

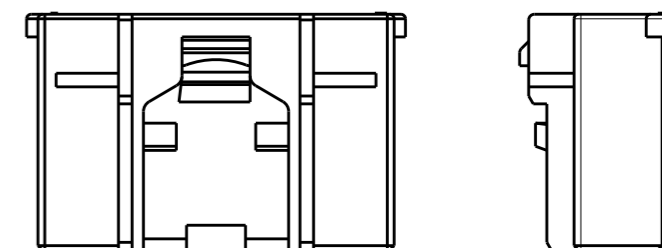

KEY C

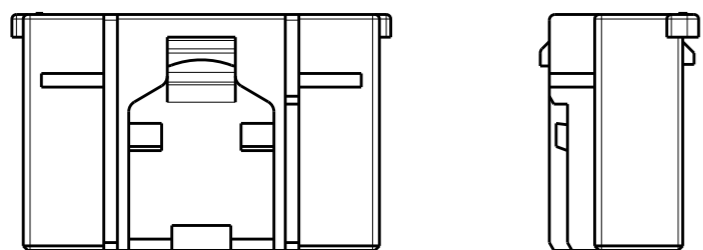

KEY D

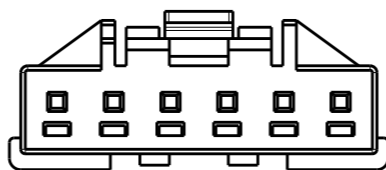
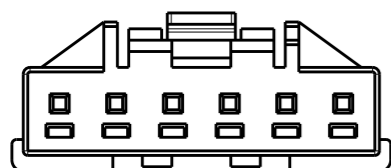
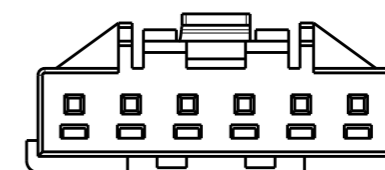
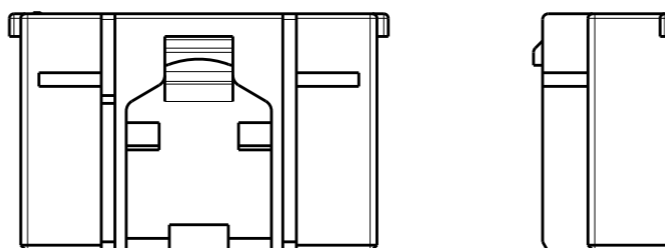

KEY TYPE 6-1971793-1 AS SHOWN

THIS DRAWING IS A CONTROLLED DOCUMENT.

DIMENSIONS:  
mm

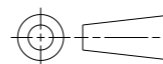

TOLERANCES UNLESS OTHERWISE SPECIFIED

- 0 PLC ±0.3
- 1 PLC ±0.3
- 2 PLC ±0.13
- 3 PLC ±0.013
- 4 PLC ±0.0001
- ANGLES ±3

MATERIAL -

FINISH -

DWN 15MAY2015

ANNIE QIAN

CHK 15MAY2015

ANNIE QIAN

APVD 15MAY2015

DANIEL ZHANG

PRODUCT SPEC

108-106077

APPLICATION SPEC

114-106077

WEIGHT -

CUSTOMER DRAWING



TE Connectivity

NAME  
NEXT GENERATION  
GRACE INERTIA CONNECTOR 2.5  
PLUG HOUSING

SIZE A3 CAGE CODE - DRAWING NO. ©-1971793 RESTRICTED TO -

SCALE 5:1 SHEET 3 OF 3 REV G1

## X-ON Electronics

Largest Supplier of Electrical and Electronic Components

*Click to view similar products for [Headers & Wire Housings](#) category:*

*Click to view products by [TE Connectivity](#) manufacturer:*

Other Similar products are found below :

[892-18-020-10-001101](#) [58102-G61-06LF](#) [582553-1](#) [0009485154](#) [009176003701906](#) [0050291907](#) [LY20-4P-DT1-P1E-BR](#) [02.125.8002.8](#)  
[609-3404](#) [61062-3](#) [61082-181009](#) [622-3653LF](#) [63453-116](#) [636-1030](#) [636-1427](#) [636-3427](#) [636-4007](#) [641938-9](#) [641991-4](#) [644827-2](#) [65817-](#)  
[010LF](#) [65817-015LF](#) [65863-015LF](#) [66207-023LF](#) [67095-007LF](#) [67601157](#) [68645-018](#) [68648-049](#) [70.362.1628.0](#) [70-4210](#) [70-4226B](#) [70-](#)  
[4853B](#) [707-5020](#) [707-5028](#) [71.350.2428.0](#) [71918-208LF](#) [71961-016LF](#) [733-134](#) [733-162](#) [754199-000](#) [760-3052](#) [787-8014-00](#) [79531-3000](#)  
[FCN-360C032-B](#) [FCN-367T-T012/H](#) [FCN-723D010/2](#) [80.063.4001.1](#) [800-90-001-10-001000](#) [800-90-010-10-002000](#) [801-43-002-10-013000](#)