

THIS DRAWING IS UNPUBLISHED.

RELEASED FOR PUBLICATION

© COPYRIGHT - BY - TE CONNECTIVITY

ALL RIGHTS RESERVED.

LOC - -

DIST - -

REVISIONS

P	LTR	DESCRIPTION	DATE	DWN	APVD
F		ECR-15-007519	19AUG2015	A.Q	D.Z
G		ECR-15-015566	19OCT2015	A.Q	D.Z
GI		ECR-17-017050	23NOV2017	C.X	D.Z

(2 POS.)

(6 POS.)

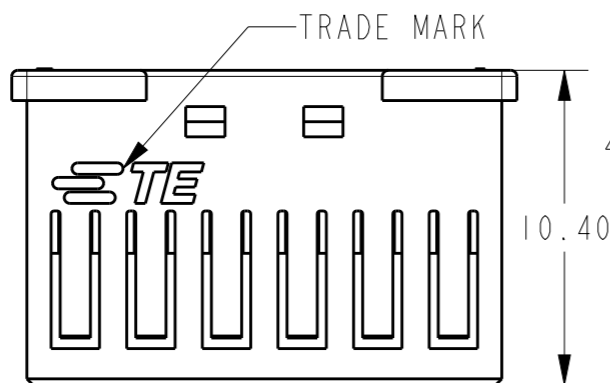
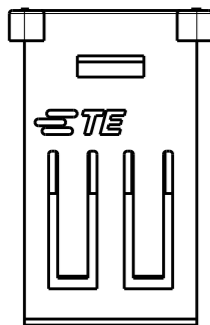

Notes:
 1 GENERAL TOLERANCE $\pm 0.3, \pm 3^\circ$
 2 MATERIAL: PA66 GF(UL94V-0)
 3 6-1971793-1 AS SHOWN ARE ONLY FOR P/N IN TABLE I
 4 APPLICABLE CONTACT P/N: 1971795-1
 5 RESTRICTED TO SPECIAL CUSTOMER (HAIER)

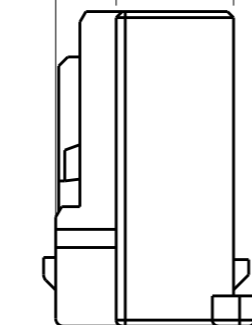
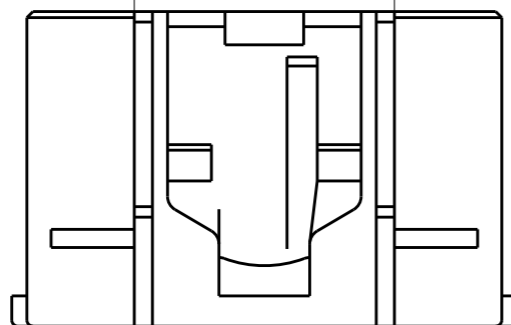
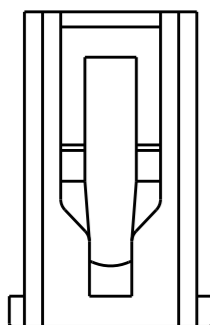
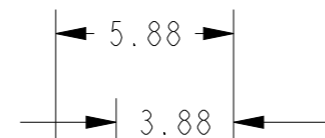
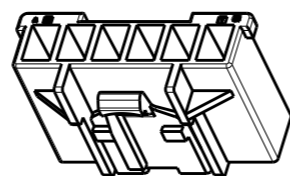
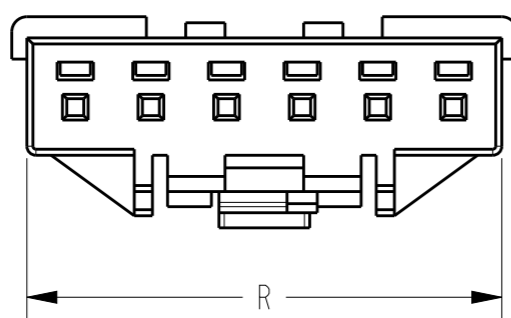
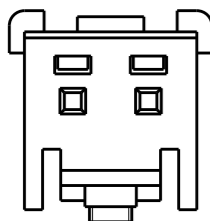

MATING CONN P/N	COLOR	KEYING	R	M	P	N(POS.)	P/N
3-1971798-4	YELLOW	D	8.2	5	6.2	3	3-2232701-4
3-1971798-2	BLUE	B					3-2232701-2
2-1971798-1	NATURAL	A	5.7	2.5	5.7	2	2-2232701-1
6-1971798-X 6-1971800-X	NATURAL	NA	15.7	12.5	8.6	6	6-1971793-6
	BLACK	D					6-1971793-5
	YELLOW	D					6-1971793-4
	RED	C					6-1971793-3
	BLUE	B					6-1971793-2
	NATURAL	A					6-1971793-1
5-1971798-X 5-1971800-X	BLACK	D	13.2	10	8.6	5	5-1971793-5
	YELLOW	D					5-1971793-4
	RED	C					5-1971793-3
	BLUE	B					5-1971793-2
	NATURAL	A					5-1971793-1
4-1971798-X 4-1971800-X	BLACK	D	10.7	7.5	7.4	4	4-1971793-5
	YELLOW	D					4-1971793-4
	RED	C					4-1971793-3
	BLUE	B					4-1971793-2
3-1971798-X 3-1971800-X	NATURAL	A	8.2	5	6.2	3	4-1971793-1
	BLACK	D					3-1971793-5
	YELLOW	D					3-1971793-4
	RED	C					3-1971793-3
	BLUE	B					3-1971793-2
2-1971798-X 2-1971800-X	NATURAL	A	5.7	2.5	5.7	2	3-1971793-1
	BLACK	D					2-1971793-5
	YELLOW	D					2-1971793-4
	RED	C					2-1971793-3
	BLUE	B					2-1971793-2
	NATURAL	A					2-1971793-1

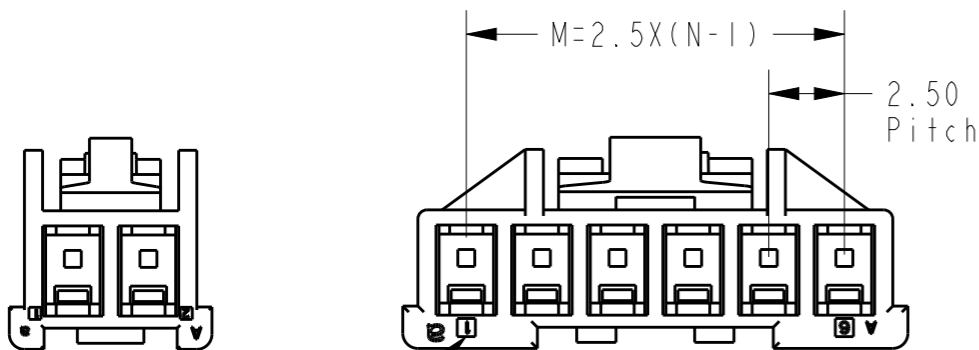

CIRCUIT NO. 1

THIS DRAWING IS A CONTROLLED DOCUMENT.

DIMENSIONS: mm

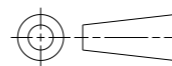

MATERIAL SEE NOTE

TOLERANCES UNLESS OTHERWISE SPECIFIED:

0 PLC	± 0.3
1 PLC	± 0.3
2 PLC	± 0.13
3 PLC	± 0.013
4 PLC	± 0.0013
ANGLES	± 3

FINISH -

DWN HJ.Z 28MAY2013

CHK HJ.Z 28MAY2013

APVD YH.M 28MAY2013

PRODUCT SPEC 108-106077

APPLICATION SPEC 114-106077

WEIGHT -

Customer Drawing



NAME NEXT GENERATION GRACE INERTIA CONNECTOR 2.5 PLUG HOUSING

SIZE A3 CAGE CODE - DRAWING NO. C-1971793 RESTRICTED TO -

SCALE 5:1 SHEET 1 OF 3 REV GI

THIS DRAWING IS UNPUBLISHED.

RELEASED FOR PUBLICATION

20

© COPYRIGHT 20 BY -

ALL RIGHTS RESERVED.

LOC	DIST	REVISIONS					
		P	LTR	DESCRIPTION	DATE	DWN	APVD
-	-	-	-	SEE SHEET 1	-	-	-

7-1971793-1 AS SHOWN FOR P/N IN TABLE 2

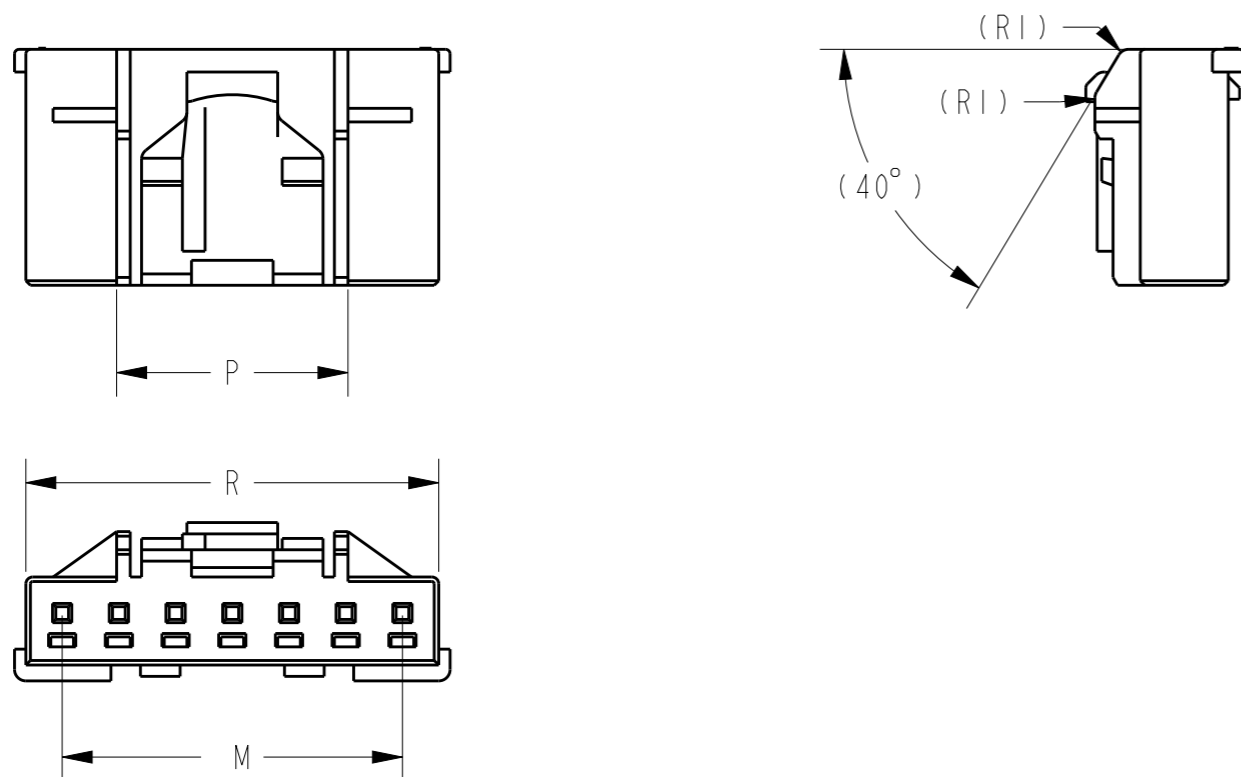

Notes:
 1 DIMENSIONS SHOWING IN SHEET 2 ARE ONLY FOR P/N IN TABLE 2
 2 DIMENSIONS NOT SHOWING IN SHEET 2 ARE THE SAME WITH DIMENSIONS IN SHEET 1

TABLE 2							
MATING CONN P/N	COLOR	KEYING	R	M	P	N (POS.)	P/N
8-1971798-X 8-1971800-X	BLACK	D	20.7	17.5	10.2	8	8-1971793-5
	YELLOW	D					8-1971793-4
	RED	C					8-1971793-3
	BLUE	B					8-1971793-2
	NATURAL	A					8-1971793-1
7-1971798-X 7-1971800-X	BLACK	D	18.2	15	10.2	7	7-1971793-5
	YELLOW	D					7-1971793-4
	RED	C					7-1971793-3
	BLUE	B					7-1971793-2
	NATURAL	A					7-1971793-1

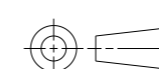
THIS DRAWING IS A CONTROLLED DOCUMENT.		DWN ANNIE QIAN 08MAY2015	 TE Connectivity	
DIMENSIONS: mm		CHK ANNIE QIAN 08MAY2015		
		APVD DANIEL AHGN 08MAY2015	NAME NEXT GENERATION GRACE INERTIA CONNECTOR 2.5 PLUG HOUSING	
TOLERANCES UNLESS OTHERWISE SPECIFIED		PRODUCT SPEC 108-106077	RESTRICTED TO	
0 PLC ±. 1 PLC ±0.3 2 PLC ±0.13 3 PLC ±0.013 4 PLC ±0.000J ANGLES ±3		APPLICATION SPEC 114-106077	SIZE A3	CAGE CODE -
MATERIAL -	FINISH -	WEIGHT -	DRAWING NO C-1971793	SCALE 5:1
CUSTOMER DRAWING			SHEET 2	OF 3
			REV G1	

THIS DRAWING IS UNPUBLISHED.

RELEASED FOR PUBLICATION

20

© COPYRIGHT 20 BY -

ALL RIGHTS RESERVED.

LOC	DIST
-	-

REVISIONS					
P	LTR	DESCRIPTION	DATE	DWN	APVD
-	-	SEE SHEET 1	-	-	-

KEY A

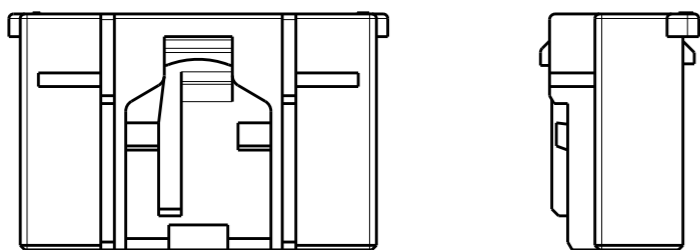

KEY B

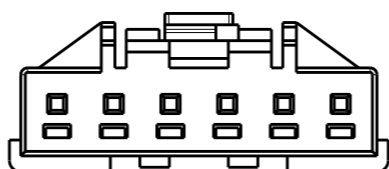
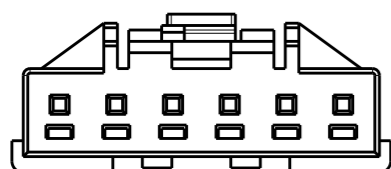
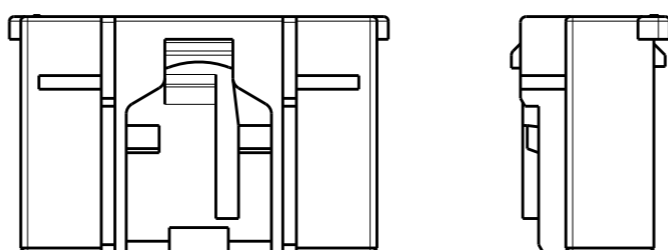

FOR 6-1971793-6 NO KEY

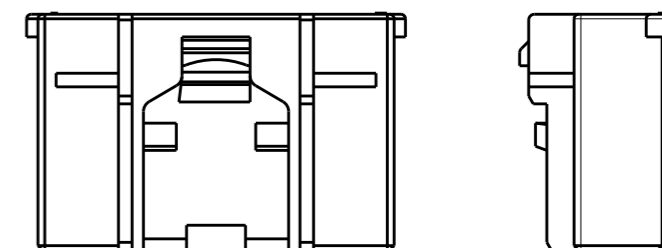

KEY C

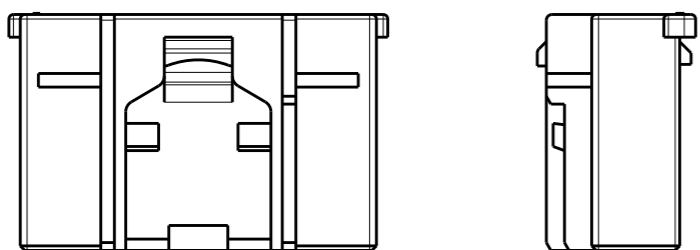

KEY D

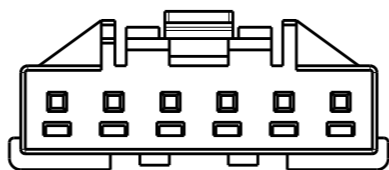
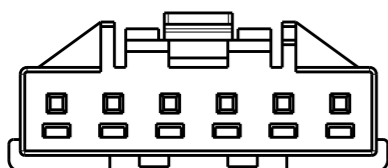
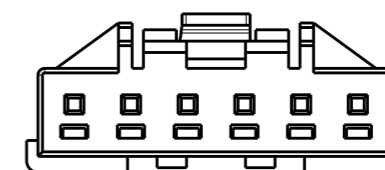
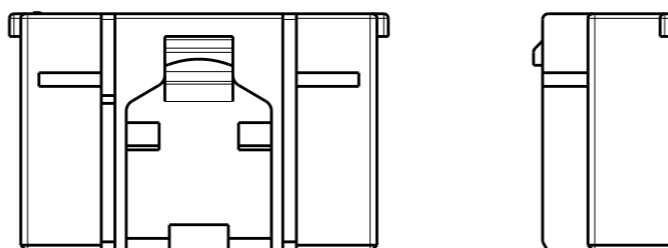

KEY TYPE 6-1971793-1 AS SHOWN

THIS DRAWING IS A CONTROLLED DOCUMENT.

DIMENSIONS:
mm

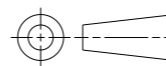

TOLERANCES UNLESS OTHERWISE SPECIFIED

0 PLC	±0.3
1 PLC	±0.13
2 PLC	±0.013
3 PLC	±0.001
4 PLC	±0.001
ANGLES	±3

MATERIAL -

FINISH -

DWN	ANNIE QIAN	15MAY2015
CHK	ANNIE QIAN	15MAY2015
APVD	DANIEL ZHANG	15MAY2015
PRODUCT SPEC	108-106077	
APPLICATION SPEC	114-106077	
WEIGHT	-	



NAME
NEXT GENERATION
GRACE INERTIA CONNECTOR 2.5
PLUG HOUSING

SIZE	CAGE CODE	DRAWING NO	RESTRICTED TO
A3	-	6-1971793	-

CUSTOMER DRAWING	SCALE 5:1	SHEET 3 OF 3	REV G1
------------------	-----------	--------------	--------

X-ON Electronics

Largest Supplier of Electrical and Electronic Components

Click to view similar products for [Headers & Wire Housings](#) category:

Click to view products by [TE Connectivity](#) manufacturer:

Other Similar products are found below :

[892-18-020-10-001101](#) [58102-G61-06LF](#) [582553-1](#) [0009485154](#) [009176003701906](#) [0050291907](#) [LY20-4P-DT1-P1E-BR](#) [02.125.8002.8](#)
[609-3404](#) [61062-3](#) [61082-181009](#) [622-3653LF](#) [63453-116](#) [636-1030](#) [636-1427](#) [636-3427](#) [636-4007](#) [641938-9](#) [641991-4](#) [644827-2](#) [65817-](#)
[010LF](#) [65817-015LF](#) [65863-015LF](#) [66207-023LF](#) [67095-007LF](#) [67601157](#) [68645-018](#) [68648-049](#) [70.362.1628.0](#) [70-4210](#) [70-4226B](#) [70-](#)
[4853B](#) [707-5020](#) [707-5028](#) [71.350.2428.0](#) [71918-208LF](#) [71961-016LF](#) [733-134](#) [733-162](#) [754199-000](#) [760-3052](#) [787-8014-00](#) [79531-3000](#)
[FCN-360C032-B](#) [FCN-367T-T012/H](#) [FCN-723D010/2](#) [80.063.4001.1](#) [800-90-001-10-001000](#) [800-90-010-10-002000](#) [801-43-002-10-013000](#)