



REVISIONS					
P	LTR	DESCRIPTION	DATE	DWN	APVD
	H1	REDRAWN PER ECO-17-007400	12DEC2017	RS	DR

<b>AMP</b> WIRE RANGE	 Listed FILE E13288	 LR7189 Certified
16-14 AWG SOLID OR STRANDED	16-14 AWG SOLID OR STRANDED	16-14 AWG SOLID OR STRANDED

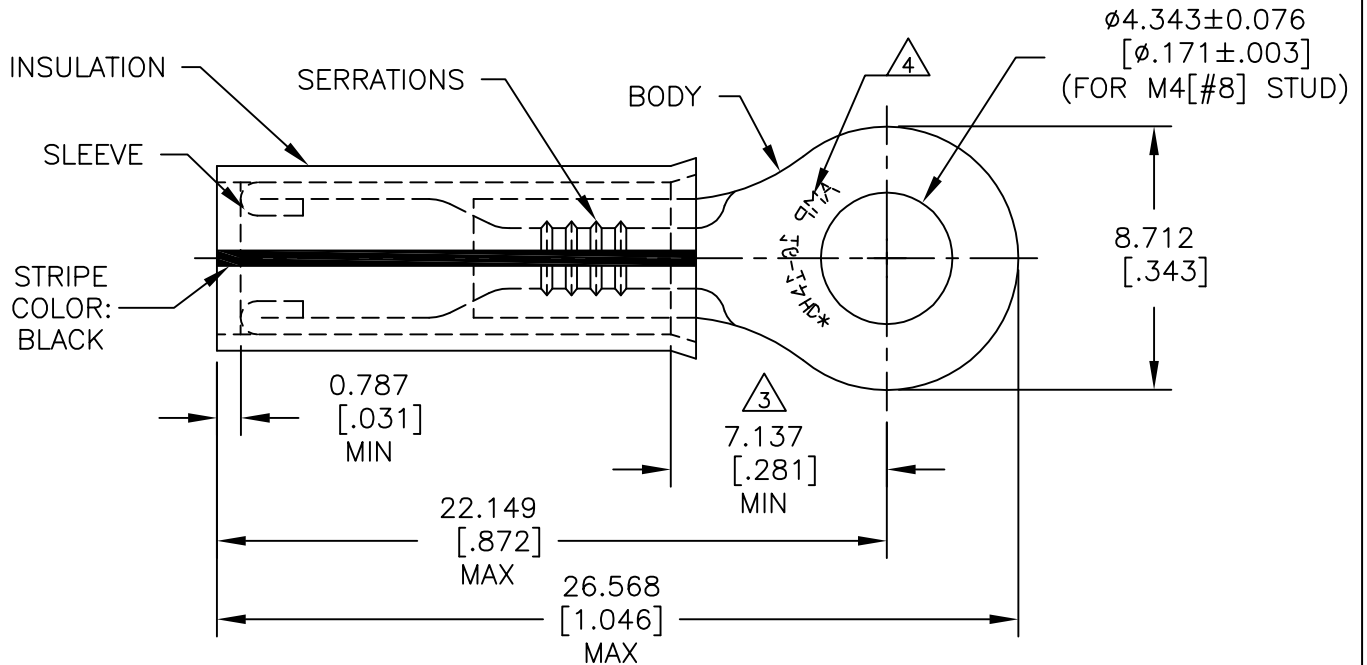

1 FOR  $\phi 3.810[\phi.150]$  TO  $\phi 5.842[\phi.230]$  WIRE INSULATION.

2 BODY MATERIAL THICKNESS:  $1.219 \pm 0.051[.048 \pm .002]$

 APPLIES FROM EDGE OF METAL WIRE BARREL TO CENTER OF STUD HOLE.

 STAMP AMP 16-14\* APPROX AS SHOWN.

 MATERIAL:  
BODY & SLEEVE: COPPER PER ASTM B152  
INSULATION: NYLON PER ASTM D4066, TYPE I.

 FINISH:  
BODY & SLEEVE: TIN PLATE PER ASTM B545  
INSULATION: COLOR-YELLOW.



2500	ON TAPE	1-320627-0
500	LOOSE PIECE	320627
QTY.	PACKAGE TYPE	PART NO.

RELEASED FOR PUBLICATION

ALL RIGHTS RESERVED.

TE Connectivity Ltd.

THIS DRAWING IS UNPUBLISHED.

DIMENSIONS: mm [INCHES]	DWN RAVI S	12DEC2017	MATERIAL		FINISH	
	CHK ROHDE DANIEL F	12DEC2017	 TE Connectivity			
TOLERANCES UNLESS OTHERWISE SPECIFIED:	APVD ROHDE DANIEL F	12DEC2017				
0 PLC ± -	PRODUCT SPEC	UL 486 A-B	NAME WIRE TERMINAL, P.I.D.G-RING TONGUE, WIRE SIZE: 16-14 AWG HD			
1 PLC ± -	APPLICATION SPEC	114-2157	SIZE	CAGE CODE	DRAWING NO	RESTRICTED TO
2 PLC ± -	WEIGHT	-	A4	00779	C= 320627	-
3 PLC ± 0.127[.005]	CUSTOMER DRAWING					
4 PLC ± -	SCALE 4:1			SHEET 1 OF 1		REV H1
ANGLES ± -						

## X-ON Electronics

Largest Supplier of Electrical and Electronic Components

*Click to view similar products for [Terminals](#) category:*

*Click to view products by [TE Connectivity](#) manufacturer:*

Other Similar products are found below :

[00-054007-01074-6](#) [00-054007-70206-1](#) [00-054007-70210-8](#) [00-054007-70217-7](#) [00-054007-70226-9](#) [00-054007-70228-3](#) [00-054007-70248-1](#) [00-054007-70256-6](#) [00-054007-70301-3](#) [00-054007-70316-7](#) [0-0320562-0](#) [00-054007-49560-4](#) [00-054007-70209-2](#) [00-054007-70225-2](#) [00-054007-70227-6](#) [00-054007-70231-3](#) [00-054007-70241-2](#) [00-054007-70242-9](#) [00-054007-70244-3](#) [00-054007-70246-7](#) [00-054007-70263-4](#) [00-054007-70288-7](#) [00-054007-70290-0](#) [00-054007-70300-6](#) [00-054007-70304-4](#) [01-2065-1-0216](#) [01-2900-1-04412](#) [00581P0075](#) [600TS-10](#) [60205-1](#) [604200-1](#) [605601-1](#) [60598-1-CUT-TAPE](#) [61314-6-C](#) [61810-3](#) [61-S](#) [61-SN](#) [626-0194](#) [62-NBM-A](#) [62-SN](#) [62-SP](#) [63-S](#) [640179-1](#) [M55155/059I03](#) [M55155/079C01](#) [M55155/099H02](#) [M55155/109H01](#) [M55155/109H02](#) [M55155/12XH05](#) [M55155/16XH02](#)