

Quick Reference Guide

INDUSTRIAL RELAYS

RELAYS, CONTACTORS & CIRCUIT BREAKERS

TE Connectivity (TE) has extensive capabilities in the design and manufacture of relays and a broad portfolio of switching solutions for demanding, high performance applications. These relay products are remotely actuated to control electrical power flow by either interrupting or completing an electrical circuit.

Complying with standardized PCB footprints, TE offers a wide range of inrush current capabilities and addresses the complete spectrum of requirements for production lines, robotics, elevators, control panels, CNC machines, motion control systems, lighting, building systems, solar, HVAC, and an array of safety-critical applications. Through agency approved test labs, we ensure that our relays are tested to meet the expectations of the industry. Whether you are designing for harsh or indoor applications, TE delivers high quality relays from state-of-the-art production lines.



CONTENTS

RELAYS, CONTACTORS & CIRCUIT BREAKERS

| | |
|----------------------------------|----|
| Power PCB Relays up to 16A..... | 4 |
| Power PCB Relays up to 50A+..... | 11 |
| Force Guided Relays..... | 14 |
| Panel Plug-In Relays | 16 |
| Signal Relays..... | 22 |
| High Frequency Relays | 27 |
| Solid State Relays..... | 28 |
| Circuit Breakers | 33 |
| Transformers..... | 36 |

MOTION CONTROL



WHAT'S INSIDE

Power PCB Relays up to 16A

Relays, Contactors & Circuit Breakers

Key Features

SCHRACK PE

Low height 10.0mm
Sensitive 200mW coil
Mono-or bistable coil
WG type available (IEC 60335-1)

SCHRACK RE/REL

Miniature PCB relays
PCB area 200mm²
Wash tight

PCJ

Slim outline
Sensitive coil 200mW
WG type available (IEC 60335-1)
Ambient temperature up to 105°C

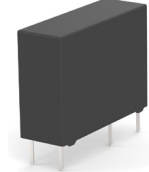
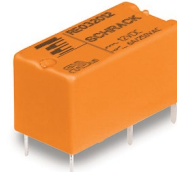

Footprint

2) see footnote below

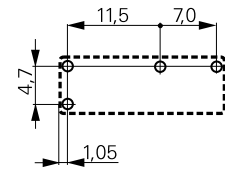
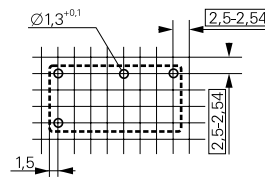
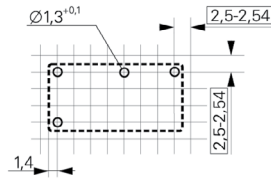

Applications

Industrial electronics
White goods
Measurement and control

PLC; Timers; I/O cards
Temperature control
White goods

Home applications
HVAC

Contact Data

| | | | |
|-------------------------------|--------------------------------|-----------------------|------------------------|
| Contact arrangement | 1 form C (CO) | 1 form A (NO) | 1 form A (NO) |
| Rated voltage | 250VAC | 250VAC | 250VAC |
| Rated current | 5A (CO) 6A (NO) | 6/5A | 3A/5A (WG type) |
| Switching power / Max. break | 1250VA | 1500/1250VA | 750VA/1250VA (WG type) |
| Contact material | AgNi 90/10, AgSnO ₂ | AgNi 0.15, AgNi 90/10 | AgNi |
| Min. recommended contact load | 1) see footnote below | 1) see footnote below | 100mA at 5VDC |

Coil Data

| | | | |
|--------------------|--------------|------------|------------|
| Magnetic system | DC, bistable | DC | DC |
| Rated coil voltage | 3 to 48VDC | 5 to 48VDC | 5 to 24VDC |
| Rated coil power | 200mW | 200/360mW | 200mW |

Dielectric Strength

| | | | | |
|-----------------------------|---------------------------|----------|---------------|----------|
| Initial dielectric strength | between open contacts | 1000Vrms | 1000Vrms | 750Vrms |
| | between contact and coil | 4000Vrms | 4000/3000Vrms | 4000Vrms |
| | between adjacent contacts | | | |
| Clearance/creepage | between contact and coil | 3.2/4mm | 4/4mm | 8/>8mm |

Other Data

| | | | |
|---|-------------|-----------------------------|------------------------|
| Ambient temperature (max.) | + 85°C | +70°C (RE)/ + 85°C (REL) | + 85/ +105°C (WG type) |
| Category of environmental protection IEC61810 | RTII, RTIII | RTIII(RE), RTII(REL) | RTII, RTIII |
| Terminal type | THT | THT | THT |
| Mounting | PCB | PCB | PCB |
| Dimensions | 20x10x10mm | 20x10x10.6mm/20.7x10.7x12mm | 20.4x7x15mm |

Accessories

| | | | |
|-------------------|----------------------------|---|---------------------|
| Link to datasheet | SCHRACK PE | SCHRACK RE SCHRACK REL | PCJ |
|-------------------|----------------------------|---|---------------------|

1) Recommended minimum load indication for contact material: AU and gold plated: 1mA at 6VDC; AgNi0.15 and AgNi90/10: 10mA at 12VDC; AgCdO and AgSnO₂: 100mA at 12VDC. Please contact technical support for detailed technical data. 2) Footprint images are representative. For a complete selection, refer to the TE data sheet via the link above.

Power PCB Relays up to 16A

Relays, Contactors & Circuit Breakers

Key Features

PCH

Compact size
WG type available (IEC 60335-1)
TV-3 ratings for NO contact

OJ/OJE/T77

Miniature size
Sensitive coil 200mW
4kV coil-contacts (OJ/OJT)
Meet UL TV-5 ratings (OJT)

PCN/PCNH

1 pole 3A/5A
Only 5mm wide
Allows high function/packaging density
RoHS compliant
(Directive 2002/95/EC)

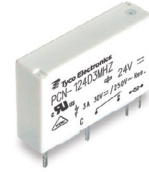

Footprint

2) see footnote below

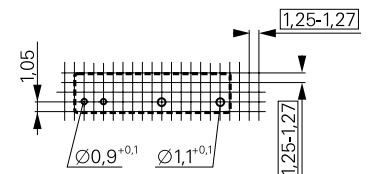
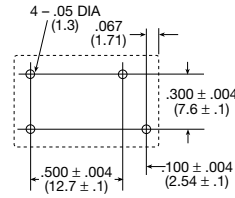
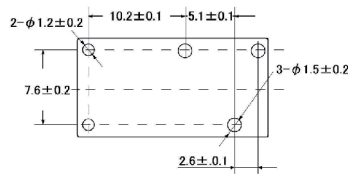

| Applications | Appliances HVAC Refrigerators, microwave ovens | Appliances HVAC Industrial control | PLC Temperature control I/O modules |
|---|--|---|---|
| Contact Data | | | |
| Contact arrangement | 1 form C (CO), 1 form A (NO) | 1 form A (NO) | 1 form A (NO) |
| Rated voltage | 277VAC/30VDC | 250VAC/28VDC | 250VAC |
| Rated current | 3/5/10A | 3/5/8/10A | 3A/5A |
| Switching power / Max. break | 1400VA/150W (NO) 850VA/90W (NC) | 720 to 2500VA/ 90 to 240W | 750VA /1250VA |
| Contact material | AgSnO ₂ | Ag, AgCdO, AgSnO ₂ | AgNi gold plated |
| Min. recommended contact load | 100mA at 5VDC | 1) see footnote below | 100mA at 5VDC |
| Coil Data | | | |
| Magnetic system | DC, sensitive | DC, sensitive | DC |
| Rated coil voltage | 3 to 48VDC | 3 to 48VDC | 3 to 24VDC |
| Rated coil power | 200/400mW | 200/250/450mW | 100mW/120mW |
| Dielectric Strength | | | |
| Initial dielectric strength | | | |
| between open contacts | 750Vrms | 750/1000Vrms | 750Vrms |
| between contact and coil | 4000Vrms | 3000/4000Vrms | 3000Vrms |
| between adjacent contacts | | | |
| Clearance/creepage | | | |
| between contact and coil | 1.6/3.2mm | 1.6/3.2mm and 3.2/6.4mm | 3.5mm |
| Other Data | | | |
| Ambient temperature (max.) | +70°C (standard)/+85°C (WG type) | up to 85°C | +85°C |
| Category of environmental protection IEC61810 | RTII, RTIII | RTII, RTIII | RTIII |
| Terminal type | THT | THT | THT |
| Mounting | PCB | PCB | PCB |
| Dimensions (lwh) | 20x10x15.2mm | 18.2x10.2x14.7mm | 20x5x12.5mm |
| Accessories | | | |
| Link to datasheet | PCH | OJ/OJE T77 | PCN |

1) Recommended minimum load indication for contact material: AU and gold plated: 1mA at 6VDC; AgNi015 and AgNi90/10: 10mA at 12VDC; AgCdO and AgSnO₂: 100mA at 12VDC. Please contact technical support for detailed technical data. 2) Footprint images are representative. For a complete selection, refer to the TE data sheet via the link above.

Key Features

SCHRACK SNR

5mm wide slim outline
Strong coil pins for DIN-rail socket
Allows high function/
packaging density

SCHRACK RYII

Reflow solderable version
Low height 12.3mm
Reinforced insulation
Pinnings 3.2mm and 5mm

SCHRACK MSR/T75

High inrush currents with AgSnO contacts
4kV/8mm coil-contact
Reinforced insulation

Footprint

2) see footnote below

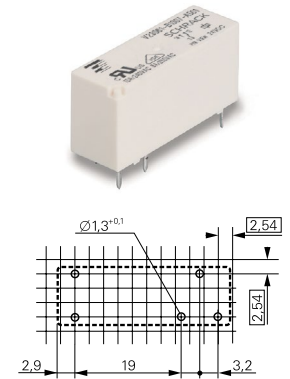
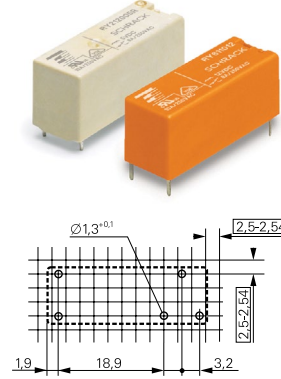
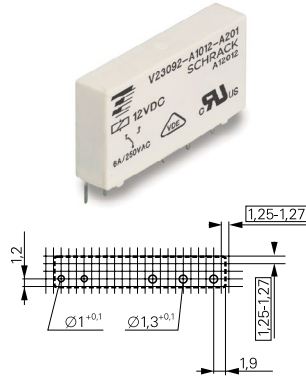

| Applications | Interface technology PLC, timers, Heating control | Interface technology HVAC, PLC, Power supplies Domestic appliances | Interface technology HVAC, PLC, Power supplies Domestic appliances |
|---|--|--|--|
| Contact Data | | | |
| Contact arrangement | 1 form C (CO), 1 form A (NO) | 1 form C (CO), 1 form A (NO), 1 form B (NC) | 1 form C (CO) 1 form A (NO) |
| Rated voltage | 250VAC | 250VAC | 250VAC |
| Rated current | 6A | 8A | 8/10A |
| Switching power / Max. break | 1500VA | 2000VA | 2000VA |
| Contact material | AgSnO ₂ , AgSnO ₂ gold plated | AgNi0.15, AgSnO ₂ , AgNi 0.15 gold plated | AgNi90/10, AgSnO ₂ |
| Min. recommended contact load | 100mA at 12VDC | 1) see footnote below | 1) see footnote below |
| Coil Data | | | |
| Magnetic system | DC | DC | DC |
| Rated coil voltage | 5 to 48VDC | 5 to 60VDC | 3 to 60VDC |
| Rated coil power | 170/217mW | (223 - 257)mW | (212-262)mW |
| Dielectric Strength | | | |
| Initial dielectric strength | | | |
| between open contacts | 1000Vrms | 1000Vrms | 1000Vrms |
| between contact and coil | 4000Vrms | 5000Vrms | 4000Vrms |
| between adjacent contacts | | | |
| Clearance/creepage | | | |
| between contact and coil | 6/8mm | 8/8mm | 8/8mm |
| Other Data | | | |
| Ambient temperature (max.) | +85°C | +70°C | +85°C |
| Category of environmental protection IEC61810 | RTIII | RTII, RTIII | RTII, RTIII |
| Terminal type | THT | THT, THR | THT |
| Mounting | PCB or on socket | PCB or on socket | PCB |
| Dimensions (lwh) | 28x5x15mm | 28.5x10.1x12.3mm | 28.6x10x15mm |
| Accessories | DIN rail sockets | PCB sockets | |
| Link to datasheet | SCHRACK SNR | SCHRACK RYII | SCHRACK MSR |

1) Recommended minimum load indication for contact material: AU and gold plated: 1mA at 6VDC; AgNi0.15 and AgNi90/10: 10mA at 12VDC; AgCdO and AgSnO₂: 100mA at 12VDC. Please contact technical support for detailed technical data. 2) Footprint images are representative. For a complete selection, refer to the TE data sheet via the link above.

Power PCB Relays up to 16A

Relays, Contactors & Circuit Breakers

Key Features

SCHRACK RZ

High performance version available
Reinforced insulation
High ambient temperature version (105°C)
WG type available (IEC 60335-1)
AgNi and AgSnO contact versions
THR (reflow) version

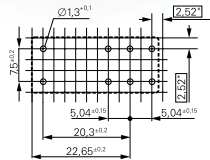
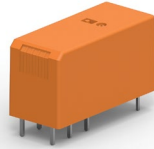

SCHRACK RT

DC and AC coil
Mono-or bistable coil
Reinforced insulation
WG type available (IEC 60335-1)
High ambient temperature version (105°C)
THR (reflow) version
Sensitive version
Bifurcated contacts

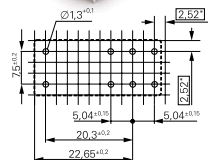

SCHRACK RT INRUSH

For inrush peak currents up to 80A
Mono-or bistable coil
Reinforced insulation
WG type available (IEC 60335-1)

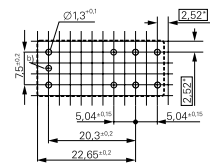

Footprint

2) see footnote below

| Applications | Household appliances HVAC, Home automation Machine control, Energy control | HVAC, Home automation, Machine control, Energy control Switching cabinet, Interface modules | Lighting applications, Movement detectors, Motors control, Domestic appliances |
|---|---|---|--|
| Contact Data | 1 form C (CO) 1 form A (NO) | 1 form C (CO), 1 form A (NO) 2 form C (CO), 2 form A (NO) | 1 form C (CO) 1 form A (NO) |
| Rated voltage | 250VAC | 250VAC | 250VAC |
| Rated current | 16A | 2X8/16A | 16A |
| Switching power / Max. break | 4000VA | 2X2000/4000VA | 4000VA |
| Contact material | AgNi90/10, AgSnO ₂ | AgNi90/10, AgSnO ₂ | AgNi90/10, AgSnO ₂ |
| Min. recommended contact load | 1) see footnote below | 1) see footnote below | 1) see footnote below |
| Coil Data | DC | DC, AC, bistable | DC, bistable |
| Rated coil voltage | 5 to 48VDC | 5 to 110VDC/24 to 230VAC | 5 to 11VDC |
| Rated coil power | 400mW | 400mW/0.75VA | 400mW |
| Dielectric Strength | Initial dielectric strength between open contacts between contact and coil between adjacent contacts | 1000Vrms 5000Vrms 2500Vrms | 1000Vrms 5000Vrms 2500Vrms |
| Clearance/creepage | between contact and coil | >10/10mm | >10/10mm |
| Other Data | Ambient temperature (max.) +85°C +105°C (HOT type) +70°C (transparent cover type) | +75°C (AC type) +85°C | +85°C |
| Category of environmental protection IEC61810 | RTII, RTIII | RTII, RTIII | RTII |
| Terminal type | THT | THT, THR (DC and AC type) | THT |
| Mounting | PCB | PCB or on socket | PCB or socket |
| Dimensions (lwh) | 29x12.7x15.7mm | 29x12.7x15.7mm | 29x12.7x15.7mm |
| Accessories | | PCB and DIN rail sockets | |
| Link to datasheet | SCHRACK RZ | SCHRACK RT | SCHRACK RT INRUSH |

1) Recommended minimum load indication for contact material: AU and gold plated: 1mA at 6VDC; AgNi0.15 and AgNi90/10: 10mA at 12VDC; AgCdO and AgSnO₂: 100mA at 12VDC. Please contact technical support for detailed technical data. 2) Footprint images are representative. For a complete selection, refer to the TE data sheet via the link above.

Power PCB Relays up to 16A

Relays, Contactors & Circuit Breakers

Key Features

SCHRACK RP-2POLE 1.5MM

2 pole 8A
1.5mm contact gap per pole
Creepage distance complies with IEC 60950
Sealed version available



SCHRACK PB/PBH

Compact and simple design gives high process security
High ambient temperature version up to 105°C (PBH)
WG type acc. IEC 60335-1



SCHRACK ORWH

Compact relay with 1 form A and 1 form C contact arrangement
10A switching capacity



Footprint

2) see footnote below

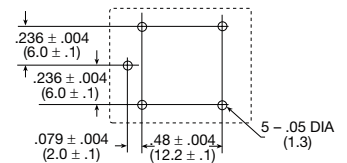
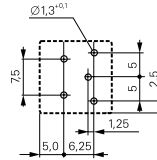
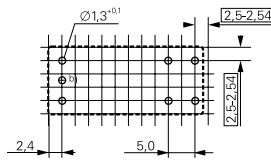

Applications

Domestic appliances
UPS
Solar Inverter

White goods
Small home appliances
Heating temperature controllers

Appliances
HVAC
Emergency lighting

Contact Data

| | | | |
|-------------------------------|--------------------|--------------------------------|--------------------------------|
| Contact arrangement | 2 form A, 2 NO | 1 form C (CO) 1 form A (NO) | 1 form C (CO) 1 form A (NO) |
| Rated voltage | 250VAC | 250VAC | 277VAC/28VDC |
| Rated current | 8A | 10A | 10A |
| Switching power / Max. break | 2000VA | 2500VA | 2770VA/360W |
| Contact material | AgSnO ₂ | AgNi90/10, AgSnO | AgZnO, AgNi |
| Min. recommended contact load | 100mA at 12VDC | 1) see footnote below | 100mA at 5VDC |

Coil Data

| | | | |
|--------------------|-------------|-------------|------------|
| Magnetic system | DC | DC | DC |
| Rated coil voltage | 5 to 110VDC | 5 to 48VDC | 5 to 24VDC |
| Rated coil power | 780mW | 360mW/500mW | 360mW |

Dielectric Strength

| | | | |
|-----------------------------|-----------|---------------|----------|
| Initial dielectric strength | | | |
| between open contacts | 25000Vrms | 1000Vrms | 750Vrms |
| between contact and coil | 5000Vrms | 2500Vrms | 1500Vrms |
| between adjacent contacts | 300Vrms | | |
| Clearance/creepage | | | |
| between contact and coil | 7/8mm | 3/4mm / 4/5mm | 3.2mm |

Other Data

| | | | |
|---|----------------|--------------|------------------|
| Ambient temperature (max.) | +40°C | +85°C/+105°C | +85°C |
| Category of environmental protection IEC61810 | RTII, RTIII | RTII | RTII, RTIII |
| Terminal type | THT | THT | THT |
| Mounting | PCB | PCB | PCB |
| Dimensions (lwh) | 29x12.6x25.5mm | 15x15x20mm | 19.0x15.5x15.8mm |

Accessories

| | | | |
|-------------------|--|---|------------------------------|
| Link to datasheet | SCHRACK RP-2POLE 1.5MM | SCHRACK PB SCHRACK PBH | SCHRACK ORWH |
|-------------------|--|---|------------------------------|

1) Recommended minimum load indication for contact material: AU and gold plated: 1mA at 6VDC; AgNi015 and AgNi90/10: 10mA at 12VDC; AgCdO and AgSnO₂: 100mA at 12VDC. Please contact technical support for detailed technical data. 2) Footprint images are representative. For a complete selection, refer to the TE data sheet via the link above.

Power PCB Relays up to 50A+

Relays, Contactors & Circuit Breakers

Key Features

Potter & Brumfield T9G

High breaking capacity
PCB and quick connect connections
4kV/8mm coil-contact
Minimum board space
(29mm x 21.5mm)
UL-class F as standard

Potter & Brumfield T9A

High breaking capacity
PCB and quick connect and
chassis mount version
UL-class F as standard
Open version available

Potter & Brumfield T9S/T9V

1 pole 35A (T9S)/40A (T9V)
Contact gap 1.5mm/1.8mm min.
Ambient temperature up to 85°C at 35A
Production in accordance to IEC 60335-1
RoHS compliant (Directive 2002/95/EC)

Footprint

2) see footnote below

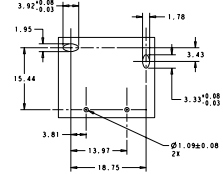
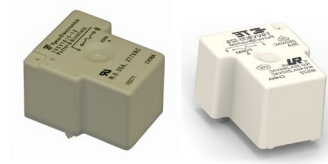
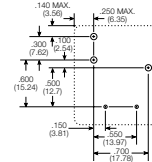
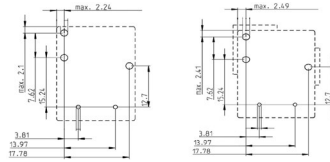

| Applications | HVAC, Appliances Industrial control Energy management | HVAC Appliances Industrial controls | Photovoltaic inverter Electrical vehicle loading stations Electrical vehicle |
|---|---|---|--|
| Contact Data | | | |
| Contact arrangement | 1 form C (1 CO) 1 form B (1 NC) 1 form A (1 NO) | 1 form C (1 CO) 1 form B (1 NC) 1 form A (1 NO) | 1 form A (1NO) |
| Rated voltage | 250VAC | 250VAC | 277VAC (1.5mm gap), 250VAC (1.8mm gap) |
| Rated current | 30A | 30A | 35A (T9S), 40A (T9V) |
| Switching power / Max. break | | 7500VA | 9695VA (T9S), 10000VA (T9V) |
| Contact material | AgSnO ₂ | AgCdO, AgSnInO | AgNi |
| Min. recommended contact load | 1A at 12VAC/VDC | 1A at 5VDC or 12VAC | 1A at 5VDC/12VAC |
| Coil Data | | | |
| Magnetic system | DC | DC | Monostable |
| Rated coil voltage | 5 to 110VDC | 6 to 48VDC | 12VDC |
| Rated coil power | 900mW | 1W/900mW | 2.25W |
| Dielectric Strength | | | |
| Initial dielectric strength | | | |
| between open contacts | 1500Vrms | 1500Vrms | 2500Vrms |
| between contact and coil | 4000Vrms | 2500Vrms | 4000Vrms |
| between adjacent contacts | | | |
| Clearance/creepage | 6.4mm / 9.5mm (UL) | | |
| between contact and coil | 8mm / 8mm (IEC) | 3.1/6.3mm | 3/4mm |
| Other Data | | | |
| Ambient temperature (max.) | +105°C | +85°C | +85°C |
| Category of environmental protection IEC61810 | RTII, RTIII | RTO, RTI, RTII, RTIII | RTII/RTIII |
| Terminal type | THT/Quick connect | THT/Quick connect | PCB |
| Mounting | PCB | PCB, panel mount | PCB |
| Dimensions (lwh) | 29x21.5x15.7mm | 32.3x27.4x20.4mm | 32x27x20mm |
| Accessories | | | |
| Link to datasheet | Potter & Brumfield T9G | Potter & Brumfield T9A | Potter & Brumfield T9V Potter & Brumfield T9S |

1) Recommended minimum load indication for contact material: AU and gold plated: 1mA at 6VDC; AgNi0.15 and AgNi90/10: 10mA at 12VDC; AgCdO and AgSnO₂: 100mA at 12VDC. Please contact technical support for detailed technical data. 2) Footprint images are representative. For a complete selection, refer to the TE data sheet via the link above.



Power PCB Relays up to 50A+

Relays, Contactors & Circuit Breakers

Key Features

Potter & Brumfield T92

Switching capacity 7500VA
DC or AC coil
4kV/8mm coil-contact
PCB or quick connect connections
or chassis mount



PCF

Quick connect terminal for load (PCF only)
Height 26.5mm
Meet 4kV dielectric voltage between coil and contact
Ambient temperature 85°C



PCFN SOLAR

Specially designed to meet the requirements for solar
Contact gap 1.5mm/1.8mm min.
200mW hold power



Footprint

2) see footnote below

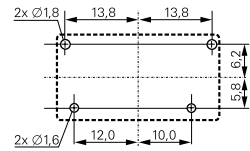
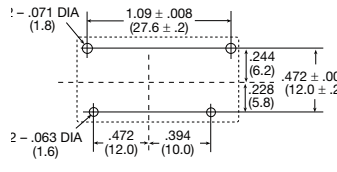
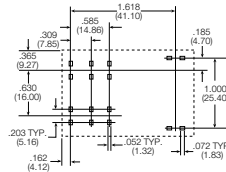

| Applications | HVAC Residential/commercial appliances Industrial controls | Appliances HVAC Office machines | Photovoltaic Inverter |
|---|--|---|----------------------------|
| Contact Data | | | |
| Contact arrangement | 2 form C (2 CO) 2 form A (2 NO) | 1 form A (1 NO) | 1 form A (1 NO) |
| Rated voltage | 400VAC | 250VAC | 277VAC |
| Rated current | 30A | 25A | 26A |
| Switching power / Max. break | 7500VAC | 6370VA | 7200VA |
| Contact material | AgCdO, AgSnInO | Visit TE.com for more information | AgSnO ₂ |
| Min. recommended contact load | 500mA (NO)/ 100mA (NC) at 12VAC | 100mA at 5VDC | 100mA at 5VDC |
| Coil Data | | | |
| Magnetic system | DC, AC | DC | DC |
| Rated coil voltage | 5 to 110VDC/12 to 240VAC | 6 to 24VDC | 12VDC and 24VDC |
| Rated coil power | 1.7W/4.0VA | 900mW | 1.5W/200mW hold power |
| Dielectric Strength | | | |
| Initial dielectric strength | | | |
| between open contacts | 1500Vrms | 1000Vrms | 2500Vrms |
| between contact and coil | 4000Vrms | 4000Vrms | 4000Vrms |
| between adjacent contacts | 2000Vrms | | |
| Clearance/creepage | | | |
| between contact and coil | 8/9.5mm | 6.7/>8mm | 6.1/6.1mm |
| Other Data | | | |
| Ambient temperature (max.) | DC Coil +85°C; AC Coil +65°C | +85°C | +85°C |
| Category of environmental protection IEC61810 | RTI, RTII, RTIII | RTII | RTII |
| Terminal type | THT/Quick connect | THT/Quick connect (#250) | PCB-THT |
| Mounting | Panel mount, PCB | PCB | PCB |
| Dimensions (lwh) | 52.3x34.6x30.8mm | 30.4x16x26.5mm | 30.4x16x26.5mm |
| Accessories | | | |
| Link to datasheet | Potter & Brumfield T92 | PCF | PCFN SOLAR |

1) Recommended minimum load indication for contact material: AU and gold plated: 1mA at 6VDC; AgNi0.15 and AgNi90/10: 10mA at 12VDC; AgCdO and AgSnO₂: 100mA at 12VDC. Please contact technical support for detailed technical data. 2) Footprint images are representative. For a complete selection, refer to the TE data sheet via the link above.

Power PCB Relays up to 50A+

Relays, Contactors & Circuit Breakers

Key Features

EW60

1 pole 60A, 1 form A (NO) contact
Polarized bistable (latching) with 1 or 2 coils
NEMA 410-2011, 16A, 277VAC, electronic ballast;
20A branch circuit
480A inrush, 2.1m sec



EW100/120

1 pole 120A, 1 form A (NO) contact
Polarized bistable with two coils latching
4KV/ 8mm coil - contact
Reinforced insulation



Footprint

2) see footnote below

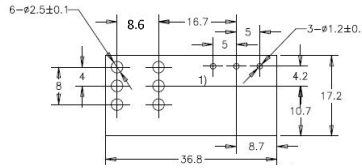

Visit TE.com for more information

Applications

Lighting control, bus actuator,
power distribution, circuit protection, inverter

Energy counter, prepaid power meter

Contact Data

| | | |
|-------------------------------|---|---|
| Contact arrangement | 1 form A (1 NO) | 1 form A (1 NO) |
| Rated voltage | 440VAC | 250VAC |
| Rated current | 60A | 100A/120A |
| Switching power / Max. break | 15000VA | 30000VA |
| Contact material | AgSnO ₂ | AgSnO ₂ |
| Min. recommended contact load | Visit TE.com for more information | Visit TE.com for more information |

Coil Data

| | | |
|--------------------|------------|------------|
| Magnetic system | Bistable | Bistable |
| Rated coil voltage | 5 to 24VDC | 6 to 24VDC |
| Rated coil power | 1.5W/3W | 4.5W |

Dielectric Strength

| | | |
|-----------------------------|----------|----------|
| Initial dielectric strength | | |
| between open contacts | 1500Vrms | 2000Vrms |
| between contact and coil | 4000Vrms | 4000Vrms |
| between adjacent contacts | | |
| Clearance/creepage | | |
| between contact and coil | ≥6/9mm | ≥10/10mm |

Other Data

| | | |
|---|------------------|---|
| Ambient temperature (max.) | +70°C | +70°C |
| Category of environmental protection IEC61810 | RTI | RTII - flux proof |
| Terminal type | PCB | PCB, Copper |
| Mounting | PCB | Visit TE.com for more information |
| Dimensions (lwh) | 36.8x17.2x30.4mm | 36.8x21.8x41.9mm |

Accessories

| | | |
|-------------------|----------------------|---------------------------|
| Link to datasheet | EW60 | EW100/120 |
|-------------------|----------------------|---------------------------|

1) Recommended minimum load indication for contact material: AU and gold plated: 1mA at 6VDC; AgNi0.15 and AgNi90/10: 10mA at 12VDC; AgCdO and AgSnO₂: 100mA at 12VDC. Please contact technical support for detailed technical data. 2) Footprint images are representative. For a complete selection, refer to the TE data sheet via the link above.

Power PCB Relays up to 50A+

Relays, Contactors & Circuit Breakers

Key Features

IHV

Hermetically sealed - intrinsically safe
Designed accordance to AIAG QS9000
No position sensitive
RoHS compliance



PCB mount not applicable.
Visit TE.com for more information

Potter & Brumfield PRD

Contact ratings to 50A
Magnetic blowout available for switching DC loads
SPDT auxiliary switch available
Class B insulation system

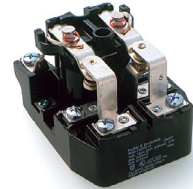

PCB mount not applicable.
Visit TE.com for more information

Applications

DC charging, Solar inverter, Energy store station
BMS, Electrical forklift, AGV, Rail transit
Circuit protection and Safety in Industrial Machinery

Industrial controls
Lighting

Contact Data

| | | |
|-------------------------------|---|--|
| Contact arrangement | 1 form X | 1 form A (1 NO) 1 form C (1 CO) 1 form X (NO-DM) 2 form A (2 NO) 2 form C (2 CO) |
| Rated voltage | 450VDC / 750VDC | 600VAC, 28/125VDC |
| Rated current | 50A/100A/150A/200A/250A/350A | 50A |
| Switching power / Max. break | | 12000VA |
| Contact material | | Ag, AgCdO |
| Min. recommended contact load | Visit TE.com for more information | 1A at 12VDC/VAC |

Coil Data

| | | |
|--------------------|---|-------------------------|
| Magnetic system | DC | DC, AC |
| Rated coil voltage | 12VDC, 24VDC or PWM | 6 to 110VDC/6 to 480VAC |
| Rated coil power | Visit TE.com for more information | 2W/9.8VA |

Dielectric Strength

| | | |
|-----------------------------|---|----------|
| Initial dielectric strength | | 2000Vrms |
| between open contacts | | 2000Vrms |
| between contact and coil | 2000Vrms | 2000Vrms |
| between adjacent contacts | | 2000Vrms |
| Clearance/creepage | | |
| between contact and coil | Visit TE.com for more information | >8mm |

Other Data

| | | |
|---|---|----------------------|
| Ambient temperature (max.) | +85°C | DC +80°C AC +45°C |
| Category of environmental protection IEC61810 | RTV | RT 0/open |
| Terminal type | Screw | Screw/Quick connect |
| Mounting | Panel mount | Panel mount |
| Dimensions (lwh) | Visit TE.com for more information | 85.7X63.8X63.5mm |

Accessories

Dust cover

Link to datasheet

[Potter & Brumfield PRD](#)

1) Recommended minimum load indication for contact material: AU and gold plated: 1mA at 6VDC; AgNi0.15 and AgNi90/10: 10mA at 12VDC; AgCdO and AgSnO₂: 100mA at 12VDC. Please contact technical support for detailed technical data.

Force Guided Relays

Relays, Contactors & Circuit Breakers

Key Features

SCHRACK SR2M

2 pole relay with force guided contacts according to EN50205
Reinforced insulation between poles

SCHRACK SR4 D/M

4 pole relay with force guided contacts according to EN50205
Compact design, space efficient



Footprint

2) see footnote below

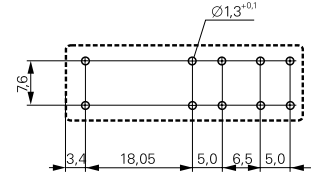
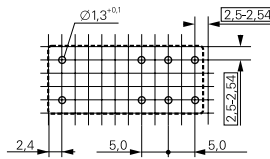

| Applications | Safety modules Process technology Elevator and Escalator control | Safety modules Process technology Elevator and Escalator control |
|---|--|--|
| Contact Data | | |
| Contact arrangement | 1 form A + 1 form B (1 NO + 1 NC) 2 form C (2 CO) | 3 form A + 1 form B (3 NO + 1 NC) 2 form A + 2 form B (2 NO + 2 NC) |
| Rated voltage | 250VAC | 250VAC |
| Rated current | 6A | 8A |
| Switching power / Max. break | 1500VA | 2000VA |
| Contact material | AgNi | AgSnO ₂ |
| Min. recommended contact load | 10mA at 5VDC | 10mA at 5VDC |
| Coil Data | | |
| Magnetic system | DC | DC |
| Rated coil voltage | 5 to 110VDC | 5 to 110VDC |
| Rated coil power | 700mW | 800mW |
| Dielectric Strength | | |
| Initial dielectric strength | | |
| between open contacts | 1500Vrms | 1500Vrms |
| between contact and coil | 4000Vrms | 4000Vrms |
| between adjacent contacts | 3000Vrms | 2500Vrms |
| Clearance/creepage | | |
| between contact and coil | 8/8mm | 10/10mm |
| Other Data | | |
| Ambient temperature (max.) | +70°C | +70°C |
| Category of environmental protection IEC61810 | RTIII | RTIII |
| Terminal type | THT/Plug-in | THT |
| Mounting | PCB/Socket | PCB |
| Dimensions (lwh) | 29x12.6x25.5mm | 40x13x16.5mm |
| Accessories | Sockets and relay clips | |
| Link to datasheet | SCHRACK SR2M | SCHRACK SR4 D/M |

1) Recommended minimum load indication for contact material: AU and gold plated: 1mA at 6VDC; AgNi0.15 and AgNi90/10: 10mA at 12VDC; AgCdO and AgSnO₂: 100mA at 12VDC. Please contact technical support for detailed technical data. 2) Footprint images are representative. For a complete selection, refer to the TE data sheet via the link above.

Panel Plug-In Relays

Relays, Contactors & Circuit Breakers

Key Features

SCHRACK SLIM INTERFACE SNR

Strong coil pins for DIN-rail socket
LED and protection circuit standard
4kV coil-contact, 6/8mm clearance/
creepage
System width only 6.2mm

SCHRACK INTERFACE RELAY RT

Strengthened pins designed to plug
into DIN-rail-sockets
Cadmium-free contacts
Complete interface solutions available
Modular concept socket/relay/module

SCHRACK INTERFACE RELAY XT

Manual test tab, optionally lockable
Mechanical and electrical indicator
Reinforced insulation
4kV/8mm dielectric strength between
coil and contact

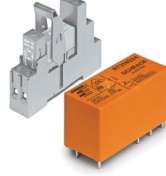

Footprint

2) see footnote below

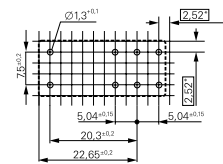
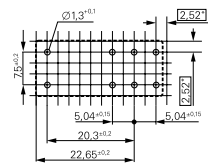
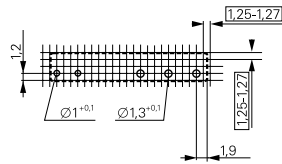

| Applications | Interface technology Panel board Mechanical engineering | Panel board Mechanical engineering Machine Industry | Panel boards Mechanical engineering |
|---|---|---|---|
| Contact Data | | | |
| Contact arrangement | 1 form C, (CO) | 1 form C, (1 CO) 2 form C, (2 CO) | 1 form C, (1 CO) 2 form C, (2 CO) |
| Rated voltage | 250VAC | 240VAC | 240VAC |
| Rated current | 6A | 8/16A | 8/16A |
| Switching power / Max. break | 1500VA | 2000/4000VA | 2000/4000VA |
| Contact material | AgSnO ₂ , AgSnO ₂ Au plated | AgSnO ₂ , AgNi90/10 AgNi90/10 Au plated | AgNi90/10 |
| Min. recommended contact load | 1) see footnote below | 1) see footnote below | 10mA at 12VDC |
| Coil Data | | | |
| Magnetic system | DC | DC, AC | DC, AC |
| Rated coil voltage | 5 to 60VDC | 5 to 110VDC/24 to 230VAC | 12 to 110VDC/24 to 230VAC |
| Rated coil power | 170mW | 400mW/0.75VA | 400mW/0.75VA |
| Dielectric Strength | | | |
| Initial dielectric strength | | | |
| between open contacts | 1000Vrms | 1000Vrms | 1000Vrms |
| between contact and coil | 4000Vrms | 4000/5000Vrms | 4000/5000Vrms |
| between adjacent contacts | | 2500Vrms | 2500Vrms |
| Clearance/creepage | | | |
| between contact and coil | ≥6/8mm | ≥8/8mm | ≥8/8mm |
| Other Data | | | |
| Ambient temperature (max.) | Relay +85°C, in socket +55°C | +70/+85°C | +70/+85°C |
| Category of environmental protection IEC61810 | RTIII | RTII | RTII |
| Terminal type | Plug-in | Plug-in | Plug-in |
| Mounting | Socket | Socket | Socket |
| Dimensions (lwh) | 28x5x15mm | 29x13x15.7mm | 29x13x26.7mm |
| Accessories | | | |
| | DIN rail sockets, jumper bars | DIN rail and PCB sockets, clips, marking tags, modules, jumper bars | DIN rail and PCB sockets, clips, marking tags, modules, jumper bars |
| Link to datasheet | SCHRACK SLIM INTERFACE SNR | SCHRACK INTERFACE RELAY RT | SCHRACK INTERFACE RELAY XT |

1) Recommended minimum load indication for contact material: AU and gold plated: 1mA at 6VDC; AgNi015 and AgNi90/10: 10mA at 12VDC; AgCdO and AgSnO₂: 100mA at 12VDC. Please contact technical support for detailed technical data. 2) Footprint images are representative. For a complete selection, refer to the TE data sheet via the link above.

Panel Plug-In Relays

Relays, Contactors & Circuit Breakers

Key Features

Potter & Brumfield R10

Broad range of coil options provide sensitivity ranging from 25 to 750mW
Various contacts switch from dry circuit to 7.5A
Many mounting and termination options

SCHRACK PT/ Potter & Brumfield KH

Sensitive coil
Low height 29/33mm
Manual test tab, optionally lockable
Mechanical indicator
Optional LED, protection diode

Potter & Brumfield K10

Mounting options include socket, PCB, top flange
DC and AC coils
LED versions available



Footprint

2) see footnote below

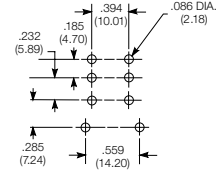
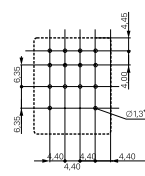
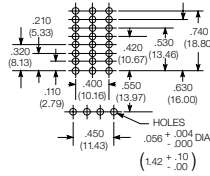

| Applications | Coin changers Audio equipment Ultrasonic test equipment | Machine industry Elevator industry Building management | Industrial controls Motor controls Industrial timers |
|---|---|---|--|
| Contact Data | | | |
| Contact arrangement | 1, 2, 3, 4, 6, 8 form C (CO) | 2 form C (2 CO) 3 form C (3 CO) 4 form C (4 CO) | 2 form C (2 CO) |
| Rated voltage | 115VAC, 115VDC | 240VAC | 120/240VAC |
| Rated current | 0.5/2/3/7.5A | 1/2/5/6/10/12A | 10/15A |
| Switching power / Max. break | 862VA max. | 1500/2500/3000VA | 1800/2500VA |
| Contact material | Ag, AgCdO, Ag w/ Au overlay | AgNi90/10, AgNi90/10 Au plated | AgCdO, AgNi90/10 |
| Min. recommended contact load | Dry circuit to 300mA at 12VDC | 1) Bifurcated contacts for dry circuit available on KH | 1) see footnote below |
| Coil Data | | | |
| Magnetic system | DC, AC | DC, AC | DC, AC |
| Rated coil voltage | 3 to 115VDC/6 to 115VAC | 6 to 220VDC/6 to 240VAC | 6 to 220VDC/6 to 240VAC |
| Rated coil power | 36mW to 1.6W/1.5VA | 750 to 900mW/1 to 1.2VA | 750 to 900mW/1 to 1.2VA |
| Dielectric Strength | | | |
| Initial dielectric strength | | | |
| between open contacts | 500/1000Vrms | 1200Vrms | 1200/1000Vrms |
| between contact and coil | 1000Vrms | 2500Vrms | 2500/1500Vrms |
| between adjacent contacts | 1000Vrms | 2000/2500Vrms | 2500/1500Vrms |
| Clearance/creepage | | | |
| between contact and coil | Visit TE.com for more information | ≥4/4mm | ≥3.1/3.1mm |
| Other Data | | | |
| Ambient temperature (max.) | +75°C | +70°C | +70°C |
| Category of environmental protection IEC61810 | RTI, RTIII | RTII | RTII |
| Terminal type | Solder/plug-in and PCB | THT, plug-in, Quick connect | Quick connect, solder, PCB |
| Mounting | Socket, panel mount and PCB | Socket, PCB | Socket and bracket mount |
| Dimensions (lwh) | 29.6x18.7x30.2mm | 28x22.5x29/30/36mm | 28x22.5x29/34.9mm |
| Accessories | | | |
| | Solder/PCB sockets, clips, hold down strap, mounting strip | DIN rail and PCB sockets, clips, marking tags, modules, jumper bars | Screw, solder and PCB sockets and clips |
| Link to datasheet | | | |
| | Potter & Brumfield R10 | Potter & Brumfield KHA SCHRACK PT | Potter & Brumfield K10 |

1) Recommended minimum load indication for contact material: AU and gold plated: 1mA at 6VDC; AgNi015 and AgNi90/10: 10mA at 12VDC; AgCdO and AgSnO₂: 100mA at 12VDC. Please contact technical support for detailed technical data. 2) Footprint images are representative. For a complete selection, refer to the TE data sheet via the link above.

Panel Plug-In Relays

Relays, Contactors & Circuit Breakers

Key Features

Potter & Brumfield KRPA/MT

Industry standard octal/undecal type termination for quick installation
DC and AC coils
Mechanical indicator, indicator lamp and push-to-test options



SCHRACK RM2/3/7

Wide selection of termination and mounting styles
PC terminals available
Push to test button and indicator lamps
Class B coil insulation

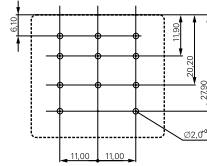

Potter & Brumfield KUP/KUMP/KUIP

Wide selection of termination and mounting styles
Broad range of contact forms
PC terminals available
Push to test button and indicator lamps
Class B coil insulation

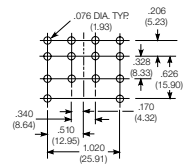

Footprint

2) see footnote below

PCB mount not applicable. Visit TE.com for more information

| Applications | Mechanical engineering Elevator control, Plant control Baggage handling | Elevator control Power supplies | HVAC Pump motor controls Hospital beds |
|---|---|--|--|
| Contact Data | | | |
| Contact arrangement | 1 form C (1 CO) (KRPA) 2 form C (2 CO) 3 form C (3 CO) | 2 form C (2 CO) 3 form C (3 CO) | 1, 2, 3, 4 form C (CO) 1, 2, 3 form A (NO) 2, 3 form B (NC) 1 form X (NO-DM) 1 form Y (NC-DB) 1 form Z (CO-DM/DB) |
| Rated voltage | 240VAC | 400VAC | 240VAC |
| Rated current | 4/10A | 10/16A | 10/15A |
| Switching power / Max. break | 500/2400/2500VA | 3800/6000VA | 2400/4155VA |
| Contact material | AgCdO, AgNi90/10, AgNi90/10 Au plated | AgCdO, AgNi90/10 in preparation | Ag, AgCdO, AgSnOInO |
| Min. recommended contact load | 1) see footnote below | 100mA at 12VDC | 100mA at 12VDC(Ag) 300mA at 12VDC (AgCdO, AnSnOInO) |
| Coil Data | | | |
| Magnetic system | DC, AC | DC, AC | DC, AC |
| Rated coil voltage | 6 to 220VDC/6 to 240VAC | 6 to 220VDC/6 to 400VAC | 5 to 110VDC/6 to 240VAC |
| Rated coil power | 760mW to 1.3W/0.74 to 2.3VA | 1.2 to 1.8W/2 to 2.8VA | 1.2 to 1.8W/2 to 2.7VA |
| Dielectric Strength | | | |
| Initial dielectric strength | | | |
| between open contacts | 1000/1500Vrms | 1500Vrms | 1200Vrms |
| between contact and coil | 1000/2500Vrms | 2500Vrms | 2200/3750Vrms |
| between adjacent contacts | 1000/2500Vrms | 2500Vrms | 2200Vrms |
| Clearance/creepage | | | |
| between contact and coil | ≥2.8/4mm | ≥4/14.9mm | Visit TE.com for more information |
| Other Data | | | |
| Ambient temperature (max.) | DC +60/+70°C AC +50/+55°C | +50/+70°C | DC +50/+70/+95°C AC +45/+55/+70°C |
| Category of environmental protection IEC61810 | RTI | RTI | RTI |
| Terminal type | Plug-in | THT, Plug-in, solder, Quick connect | THT, Plug-in, solder, Quick connect |
| Mounting | Socket | Socket, PCB, bracket, flange mount and DIN-snap-on | Socket, PCB, bracket, flange, stud and tapped core |
| Dimensions (lwh) | 35.7x35.7x50.8/57mm | 38.5x35.5x48.5mm | 38.9x35.7x48.4mm |
| Accessories | DIN rail and PCB sockets, clips, marking tags, modules | DIN rail and PCB sockets, clips | DIN rail, panel and PCB sockets, clips |
| Link to datasheet | Potter & Brumfield KRPA SCHRACK MT | SCHRACK RM2/3/7 | Potter & Brumfield KUIP KUGP KUM KUMP KUP |

1) Recommended minimum load indication for contact material: AU and gold plated: 1mA at 6VDC; AgNi015 and AgNi90/10: 10mA at 12VDC; AgCdO and AgSnO₂: 100mA at 12VDC. Please contact technical support for detailed technical data. 2) Footprint images are representative. For a complete selection, refer to the TE data sheet via the link above.



Panel Plug-In Relays

Relays, Contactors & Circuit Breakers

Key Features

SCHRACK RM8/C/D

Power relay with push-on and solder terminals
 Various mounting options
 Indicator lamps and mechanical indicator
 Optional push to test button



Potter & Brumfield KUHP

Power relay with push-on and solder terminals
 Various mounting options
 Designed to meet VDE space requirements
 Class B coil insulation

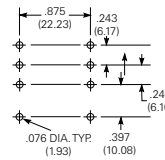

SCHRACK RM5/6/B 3MM

3mm contact gap
 DC or AC coil
 Push-to-test button
 Plug-in version, PCB terminals or chassis or DIN-rail mount

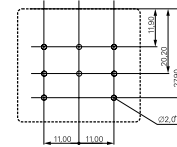

Footprint

2) see footnote below

PCB mount not applicable.
 Visit TE.com for more information

| Applications | Cleaning equipment Heating equipment Cooling equipment | Baggage handling motors Industrial pumps Commercial ovens | Power supplies Pump control |
|--------------|--|---|--------------------------------|
|--------------|--|---|--------------------------------|

Contact Data

| Contact arrangement | 1 form C (1 CO) 2 form C (2 CO) 1 form Z contact (1 NO + 1 NC) 1 form X contact (1 NO) | 1 form C (1 CO) 2 form C (2 CO) | 2 form A (2 NO) 3 form A (3NO) |
|-------------------------------|---|------------------------------------|-----------------------------------|
| Rated voltage | 400VAC | 240VAC, 50/60Hz; 28VDC | 240/400VAC |
| Rated current | 25/30/32A | 20/30A | 10/16A |
| Switching power / Max. break | 6000/7500VA | 4800/7200VA | 3800/6000VA |
| Contact material | AgCdO, AgNi90/10 | AgCdO, AgSnOInO | AgCdO, AgNi90/10 in preparation |
| Min. recommended contact load | 100mA at 12VDC | 300mA at 12VDC | 100mA at 12VDC |

Coil Data

| Magnetic system | DC, AC | DC, AC | DC, AC |
|--------------------|-------------------------|----------------------------------|-------------------------|
| Rated coil voltage | 6 to 220VDC/6 to 400VAC | 6 to 110VDC 50/60Hz. 6 to 277VAC | 6 to 220VDC/6 to 400VAC |
| Rated coil power | 1.2W/2.7VA | 1.2W/2.7VA | 1.2W/2.7VA |

Dielectric Strength

| Initial dielectric strength | | | |
|-----------------------------|---------------|---|-----------|
| between open contacts | 1500/2000Vrms | 1200Vrms | 2500Vrms |
| between contact and coil | 2500Vrms | 3750Vrms | 2500Vrms |
| between adjacent contacts | 4000Vrms | 3750Vrms | 2500Vrms |
| Clearance/creepage | | | |
| between contact and coil | ≥4/14.9mm | Visit TE.com for more information | ≥4/14.9mm |

Other Data

| Ambient temperature (max.) | DC +60/+65°C AC +40°C | DC +45°C AC +75°C | +50/+60°C |
|---|---|------------------------------------|--|
| Category of environmental protection IEC61810 | RTI | RTI, RTO | RTI |
| Terminal type | Solder/Quick connect | Solder/PCB THT/Quick connect | Plug-in, solder, Quick connect, PCB THT |
| Mounting | Bracket, top flange panel mount and DIN snap-on | Bracket and top flange panel mount | Socket, PCB, bracket, flange mount and DIN-snap-on |
| Dimensions (lwh) | 38.5x35.5x48.5mm | 38.9x35.7x48.4mm | 38.5x35.5x48.5mm |

| Accessories | No sockets | No sockets | DIN rail and PCB sockets, clips |
|-------------|------------|------------|---------------------------------|
|-------------|------------|------------|---------------------------------|

| Link to datasheet | SCHRACK RM8C/D SCHRACK RM 8 | Potter & Brumfield KUHP | SCHRACK RM5/6/B 3MM |
|-------------------|--|---|-------------------------------------|
|-------------------|--|---|-------------------------------------|

1) Recommended minimum load indication for contact material: AU and gold plated: 1mA at 6VDC; AgNi015 and AgNi90/10: 10mA at 12VDC; AgCdO and AgSnO₂: 100mA at 12VDC. Please contact technical support for detailed technical data. 2) Footprint images are representative. For a complete selection, refer to the TE data sheet via the link above.

Panel Plug-In Relays

Relays, Contactors & Circuit Breakers

Key Features

Potter & Brumfield KUGP

3mm contact gap
DC or AC coil
Plug-in version, PCB terminals or chassis mount

Potter & Brumfield KUL

Magnetic latching
Single and dual coils
Panel mounting

Potter & Brumfield KUEP

10A relay with various contact arrangements
Magnetic blowout for 150VDC load switching
Indicator lamp option

Footprint

2) see footnote below

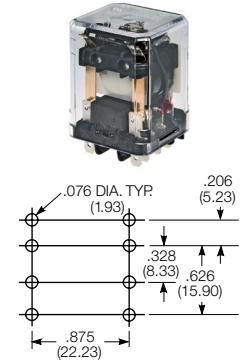
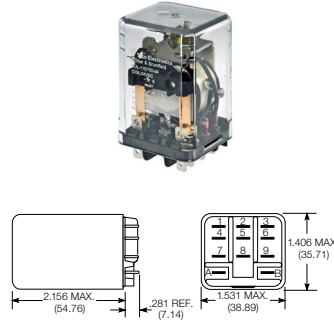
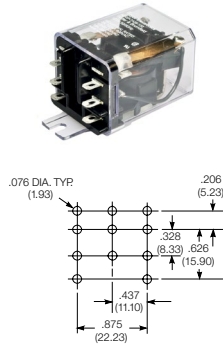

Applications

Voltage control units

Alarm systems
Machine tools
Battery chargers

DC load switching in industrial controls

Contact Data

| | | | |
|-------------------------------|--|---|--|
| Contact arrangement | 1 form C (1 CO) 2 form A (2 NO) 2 form C (2 CO) 3 form C (3 CO) | 1 form C (1 CO) 2 form C (2 CO) 3 form C (3 CO) | 1 form X (NO-DM) 2 form A (2 NO) 2 form C (2 CO) |
| Rated voltage | 240/400VAC | 28/240VAC | 150VDC/240VAC |
| Rated current | 10A | 10A | 10A |
| Switching power / Max. break | 2400VA | | 1500W/2400VA |
| Contact material | Ag, AgCdO | Ag, AgCdO | AgCdO, AgSnOInO |
| Min. recommended contact load | 100mA at 12VDC (Ag) 300mA at 12VDC (AgCdO) | 100mA at 12VDC (Ag) 300mA at 12VDC (AgCdO) | 300mA at 12VDC |

Coil Data

| | | | |
|--------------------|-------------------|---------------------------------|-------------------------|
| Magnetic system | DC, AC | DC, AC | DC, AC |
| Rated coil voltage | 6-110VDC/6-240VAC | 12 to 48VDC/24 to 120/240VAC | 5 to 110VDC/6 to 240VAC |
| Rated coil power | 1.8W/2.7VA | 1.6W dual coil/1.2W single coil | 1.2W to 1.8W/2 to 2.7VA |

Dielectric Strength

| | | | |
|-----------------------------|----------|---|---|
| Initial dielectric strength | | | |
| between open contacts | 3500Vrms | 500Vrms | 1200Vrms |
| between contact and coil | 2200Vrms | 1500Vrms | 2200Vrms |
| between adjacent contacts | 2200Vrms | 1500Vrms | 2200Vrms |
| Clearance/creepage | | | |
| between contact and coil | >8mm | Visit TE.com for more information | Visit TE.com for more information |

Other Data

| | | | |
|---|--|----------------------------|---|
| Ambient temperature (max.) | DC +75°C AC +70°C | DC +70°C AC +50/+70°C | AC +55/+70°C DC +50/+70°C |
| Category of environmental protection IEC61810 | RTI | RTI | RTI |
| Terminal type | THT, Plug-in, solder, Quick connect, PCB | .187 Quick connect, solder | Quick connect, solder and PCB |
| Mounting | Socket, PCB, bracket, flange mount | Socket, bracket | Socket, PCB, bracket and top flange mount |
| Dimensions (lwh) | 38.9x35.7x48.4mm | 38.9x35.7x54.8mm | 38.9x35.7x48.4mm |

Accessories

DIN rail and PCB sockets, clips

Screw, solder, PCB and Quick connect sockets and clips

DIN rail, track mount, chassis mount, and snap-in sockets, clips

Link to datasheet

[Potter & Brumfield KUGP](#)

[Potter & Brumfield KUL](#)

[Potter & Brumfield KUEP](#)

1) Recommended minimum load indication for contact material: AU and gold plated: 1mA at 6VDC; AgNi0.15 and AgNi90/10: 10mA at 12VDC; AgCdO and AgSnO₂: 100mA at 12VDC. Please contact technical support for detailed technical data. 2) Footprint images are representative. For a complete selection, refer to the TE data sheet via the link above.

Panel Plug-In Relays

Relays, Contactors & Circuit Breakers

Key Features

ACCESSORIES

DIN rail and PCB sockets
Screw and screwless fingersafe terminals
Retaining and ejection clips
Marking tags, jumper bars, jumper links
LED and protection modules

SETS

Relay package consisting of relay, DIN rail socket, plastic retaining clip, marking tag and module

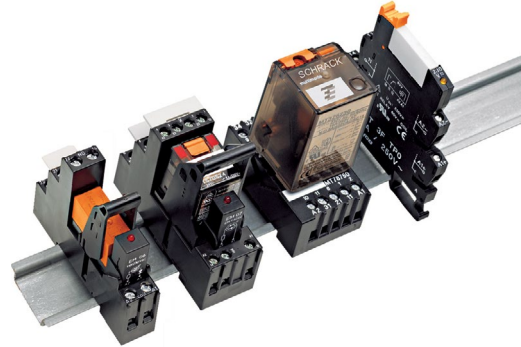

Applications

Contact Data

| | | |
|-------------------------------|--|--|
| Contact arrangement | 1 form C (1 CO) 2 form C (2 CO) 3 form C (3 CO) 4 form C (4 CO) | 1 form C (1 CO) 2 form C (2 CO) 3 form C (3 CO) 4 form C (4 CO) |
| Rated voltage | 240/250VAC | 240/250VAC |
| Rated current | 6 to 16A | 6 to 16A |
| Switching power / Max. break | | 1500 to 4000VA |
| Min. recommended contact load | | 1) see footnote below |

Coil Data

| | |
|--------------------|-------------------------|
| Magnetic system | DC, AC |
| Rated coil voltage | 6 to 220VDC/6 to 230VAC |
| Rated coil power | 170 to 700mW/0.4 to 1VA |

Dielectric Strength

Initial dielectric strength
between open contacts
between contact and coil
between adjacent contacts
Clearance/creepage
between contact and coil

Other Data

| | | |
|---|------------------------------------|------------------|
| Ambient temperature (max.) | | |
| Category of environmental protection IEC61810 | IP20 | |
| Terminal type | Screw, screwless, plate mount, PCB | Screw, screwless |
| Mounting | | |
| Dimensions (lwh) | | |

| | | |
|-------------|-------------------------------|------------------|
| Accessories | PCB, panel mount and DIN rail | DIN, panel mount |
|-------------|-------------------------------|------------------|

| | | |
|-------------------|---|---|
| Link to datasheet | ACCESSORIES SLIM INTERFACE RELAY SNR ACCESSORIES INDUSTRIAL POWER RELAY RT ACCESSORIES MINIATURE RELAY PT ACCESSORIES INTERFACE PLUG-IN RELAY XT | RELAY PACKAGE RT RELAY PACKAGE PT RELAY PACKAGE SNR ACCESSORIES MULTIMODE RELAY MT |
|-------------------|---|---|

1) Recommended minimum load indication for contact material: AU and gold plated: 1mA at 6VDC; AgNi0.15 and AgNi90/10: 10mA at 12VDC; AgCdO and AgSnO₂: 100mA at 12VDC. Please contact technical support for detailed technical data.

Signal Relays

Relays, Contactors & Circuit Breakers

Key Features

Axicom IM

4G telecom/signal relay/switching relay
Slim line 10x6mm, low-profile 5.65mm
Switching power 60W/62.5VA
Switching voltage 220VDC/250VAC
Monostable + Bistable
Low rated coil power
High dielectric version
High current version up to 5 A
High contact stability version
Bifurcated contacts + single contact

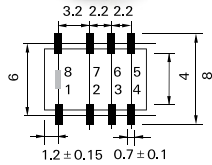
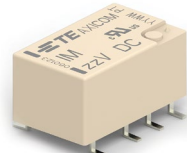

Axicom IMB

4G telecom/signal relay/switching relay
Slim line 10x6mm, low-profile 5.65mm
Switching power 60W/62.5VA
Switching voltage 220VDC/250VAC
Monostable + Bistable
Very high dielectric version
Bifurcated contacts

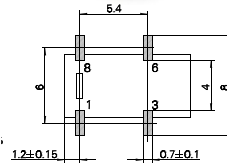
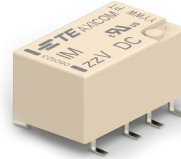

Axicom IMC

4G telecom/signal relay/switching relay
Slim line 10x6mm, low-profile 5.65mm
Switching power 60W/62.5VA
Switching voltage 220VDC/250VAC
Monostable + Bistable
High dielectric version
High current version up to 4 A
Bifurcated contacts

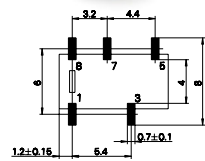
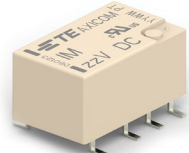

Footprint

2) see footnote below

Applications

Telecommunication, access and transmission equipment
Thermostat controls, fire and security equipment
Measurement and test equipment, Industrial controls, medical equipment

Telecommunication, access and transmission equipment
Thermostat controls, fire and security equipment
Measurement and test equipment, Industrial controls, medical equipment

Telecommunication, access and transmission equipment
Thermostat controls, fire and security equipment
Measurement and test equipment, Industrial controls, medical equipment

Contact Data

| | | | |
|-------------------------------|--|---------------------------------------|---------------------------------------|
| Contact arrangement | 2 form C, 2 CO Single contact + Bifurcated contacts | 1 form A, 1 NO Bifurcated contacts | 1 form C, 1 CO Bifurcated contacts |
| Rated voltage | 250VAC/220VDC | 250VAC/220VDC | 250VAC/220VDC |
| Rated current | 2/5A | 2A | 2/4A |
| Switching power / Max. break | 60W/62.5VA | 60W/62.5VA | 60W/62.5VA |
| Min. recommended contact load | 100µV/1µA | 100µV/1µA | 100µV/1µA |
| Initial contact resistance | <50mΩ at 10mA/30mV I: < 100mΩ | <100mΩ at 10mA/30mV | <50mΩ at 10mA/ 30mV |

Coil Data

| | | | |
|-----------------------------------|----------------|--------------|--------------|
| Magnetic system | Polarized | Polarized | Polarized |
| Rated coil voltage | 1.5 to 24VDC | 1.5 to 24VDC | 1.5 to 24VDC |
| Rated coil power | 50 to 200mW/-/ | 140mW/-/ | 140mW/-/ |
| DC coil / bistable 1 coil/2 coils | | | |

Dielectric Strength

| | | | |
|--------------------------------------|------------------|-------------|------------------|
| Initial dielectric strength | | | |
| between open contacts | 750 to 1500Vrms | 2500Vrms | 1000 to 1600Vrms |
| between contact and coil | 1500 to 1800Vrms | 3500Vrms | 1800 to 2200Vrms |
| between adjacent contacts | 750 to 1800Vrms | | |
| Initial surge withstand voltage | | | |
| between open contacts | 1000 to 2500V | 3500V | 1500 to 2200V |
| between contact and coil | 2000 to 2500V | 4900V | 2500 to 3000V |
| between adjacent contacts | 1000 to 2500V | | |
| Isolation 100/900MHz | 37.0/18.8dB | 37.0/18.8dB | 37.0/18.8dB |
| Insertion loss 100/900MHz | 0.03/0.33dB | 0.03/0.33dB | 0.03/0.33dB |
| Volt. standing wave ratio 100/900MHz | 1.06/1.49 | 1.06/1.49 | 1.06/1.49 |
| Capacitance | | | |
| between open contacts | max. 1pF | max. 1pF | max. 1pF |

Other Data

| | | | |
|--------------------------------------|--------------|--------------|--------------|
| Ambient temperature (max.) | -40 to +85°C | -40 to +85°C | -40 to +85°C |
| Category of environmental protection | IP67/RTV | IP67/RTV | IP67/RTV |
| Terminal type | THT, SMT | THT, SMT | THT, SMT |
| Dimension (lwh) | 10x6x5.65mm | 10x6x5.65mm | 10x6x5.65mm |

Link to datasheet

[Axicom IM](#)

[Axicom IMB](#)

[Axicom IMC](#)

1) Recommended minimum load indication for contact material: AU and gold plated: 1mA at 6VDC; AgNi0.15 and AgNi90/10: 10mA at 12VDC; AgCdO and AgSnO₂: 100mA at 12VDC. Please contact technical support for detailed technical data.

2) Footprint images are representative. For a complete selection, refer to the TE data sheet via the link above.

Signal Relays

Relays, Contactors & Circuit Breakers

Key Features

Axicom IMD/IME

4G telecom/signal relay/switching relay
Slim line 10x6mm, low-profile 5.65mm
Switching power 60W/62.5VA
Switching voltage 220VDC/250VAC
Monostable
Bifurcated contacts

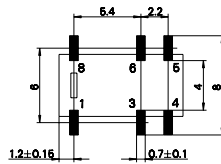
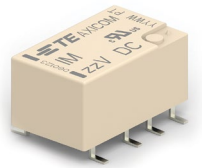

Axicom P2 / P2 HIGH DIELECTRIC VERSION

Small Signal relay
Slim line 15x7.5mm
Switching current max. 5A
High dielectric version
Meets Telcordia Technologies Inc. requirements

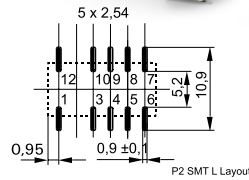
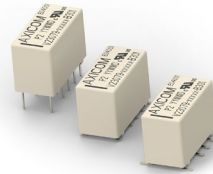

Axicom P2 LIGHTING

Small signal relay
Slim line 15x7.5mm
Switching current max. 5A
High dielectric strength 3kV
VDE certified for LED tubes

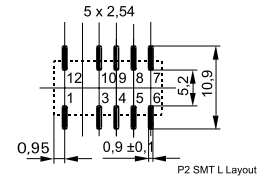
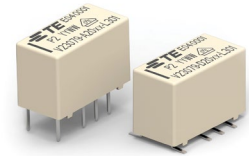

Footprint

2) see footnote below

Applications

Telecommunication, access and transmission equipment, fire and security equipment
Thermostat controls
Measurement and test equipment, Industrial controls, medical equipment

Security systems, consumer electronics, thermostats
Home automation systems, communication systems
Set top boxes, office equipment

LED tubes
Office equipment
Security systems, set top boxes

Contact Data

| | | | |
|-------------------------------|---|---------------------------------------|---------------------------------------|
| Contact arrangement | 2 form B, 2 NC 2 form A, 2 NO Bifurcated contacts | 2 form C, 2 CO Bifurcated contacts | 2 form C, 2 CO Bifurcated contacts |
| Rated voltage | 250VAC/220VDC | 250VAC/220VDC | 250VAC/220VDC |
| Rated current | 2A | 2A | 2A |
| Switching power / Max. break | 60W/62.5VA | 60W/62.5VA | 60W/62.5VA |
| Min. recommended contact load | 100µV/1µA | 100µV/1µA | 100µV/1µA |
| Initial contact resistance | <50mΩ at 10mA/20mV | <50mΩ at 10mA/20mV | <50mΩ at 10mA/20mV |

Coil Data

| | | | |
|---|--------------|------------------|------------------------|
| Magnetic system | Polarized | Polarized | Polarized |
| Rated coil voltage | 1.5 to 24VDC | 2.4 to 24VDC | 3 to 12VDC |
| Rated coil power DC coil / bistable 1 coil/2 coils | 140mW/-/- | 140mW/70mW/140mW | 140mW - 1 coil version |

Dielectric Strength

| | | | |
|--------------------------------------|-------------|------------------|----------|
| Initial dielectric strength | | | |
| between open contacts | 1000Vrms | 1000 to 1500Vrms | 1500Vrms |
| between contact and coil | 1800Vrms | 1500Vrms | 3000Vrms |
| between adjacent contacts | 1000Vrms | 1000 to 1500Vrms | 1500Vrms |
| Initial surge withstand voltage | | | |
| between open contacts | 1500V | 2000 to 2500Vrms | |
| between contact and coil | 2500V | 2500V | 6000Vrms |
| between adjacent contacts | 1500V | 2500V | |
| Isolation 100/900MHz | 37.0/18.8dB | | |
| Insertion loss 100/900MHz | 0.03/0.33dB | | |
| Volt. standing wave ratio 100/900MHz | 1.6/1.49 | | |
| Capacitance | | | |
| between open contacts | max. 1pF | | |

Other Data

| | | | |
|--------------------------------------|--------------|---|------------------------|
| Ambient temperature (max.) | -40 to +85°C | -40 to +85°C | -40 to +85°C |
| Category of environmental protection | IP67/RTV | RTIII | RTIII |
| Terminal type | THT, SMT | THT, SMT | THT, SMT |
| Dimension (lwh) | 10x6x5.65mm | 14.5x7.2x10.4mm, stnd 14.5x7.2x9.9mm, ovrrld | 14.5x7.2x9.9mm, ovrrld |

Link to datasheet

[Axicom IMD/IME](#)

[Axicom P2 / P2 HIGH DIELECTRIC VERSION](#)

[Axicom P2 LIGHTING](#)

1) Recommended minimum load indication for contact material: 1mA at 6VDC; AgNi0.15 and AgNi90/10: 10mA at 12VDC; AgCdO and AgSnO₂: 100mA at 12VDC. Please contact technical support for detailed technical data. 2) Footprint images are representative. For a complete selection, refer to the TE data sheet via the link above.

Signal Relays

Relays, Contactors & Circuit Breakers

Key Features

Axicom FP2

Slim line 14x9mm
2 form C bifurcated contacts
High mechanical shock resistance, up to 1500g survival

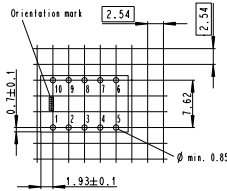
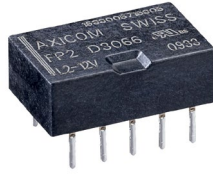

Axicom D2N V23105

2G telecom/signal relay
4 coil sensitivities
3A UL rating

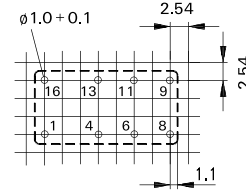

Footprint

2) see footnote below

Applications

Communication equipment
Keyless entry
Speaker switch, consumer electronics

Communication equipment
Office equipment
Measurement and control equipment

Contact Data

| | | |
|-------------------------------|---------------|-----------------------------------|
| Contact arrangement | 1 form C (CO) | 2 form C, 2 CO Single Contacts |
| Rated voltage | 220VDC/250VAC | 250VAC/220VDC |
| Rated current | 2A | 3A |
| Switching power / Max. break | 60W/62.5VA | 60W/125VA |
| Min. recommended contact load | 100µV | 100µV/10µA |
| Initial contact resistance | <50mΩ at 10mA | <100mΩ |

Coil Data

| | | |
|---|------------------------------|------------------|
| Magnetic system | Polarized | Non polarized |
| Rated coil voltage | 2 to 24VDC | 3 to 48VDC |
| Rated coil power DC coil/bistable 1 coil/2 coils | 80mW (high sensitive), 140mW | 150 to 700mW/-/- |

Dielectric Strength

| | | |
|---------------------------------------|--------------------------|-------------------------|
| Initial dielectric strength | | |
| between open contacts | 750Vrms | 750Vrms |
| between contact and coil | 1000Vrms | 1000Vrms |
| between adjacent contacts | 1000Vrms | 750Vrms |
| Initial surge withstand voltage | | |
| between open contacts | 1100V | 1500V |
| between contact and coil | 1500V | 1500V |
| between adjacent contacts | 1500V | 1500V |
| Isolation/Cross talk at 100MHz/900MHz | Cross talk -40.2/-22.3dB | Isolation -39.0/-20.7dB |
| Insertion loss 100/900MHz | 0.03dB/0.25dB | -0.02/-0.27dB |
| Volt. standing wave ratio 100/900MHz | 1.01/1.07 | 1.04/1.40 |
| Capacitance between open contacts | | max. 2pF |

Other Data

| | | |
|--------------------------------------|--------------|----------------|
| Ambient temperature (max.) | -40 to +85°C | -25 to +85°C |
| Category of environmental protection | IP67/RTIII | IP67/RTIII |
| Terminal type | THT | THT |
| Dimension (lwh) | 14x9x5mm | 20.2x10x11.4mm |

Link to datasheet

[Axicom FP2](#)

[Axicom D2N V23105](#)

1) Recommended minimum load indication for contact material: AU and gold plated: 1mA at 6VDC; AgNi0.15 and AgNi90/10: 10mA at 12VDC; AgCdO and AgSnO₂: 100mA at 12VDC. Please contact technical support for detailed technical data. 2) Footprint images are representative. For a complete selection, refer to the TE data sheet via the link above.

Signal Relays

Relays, Contactors & Circuit Breakers

Key Features

Axicom MT2

2G telecom/signal relay
5 coil sensitivities
2A UL rating

Axicom P1 V23026

Very high sensitive relay
Low-profile
High vibration and shock resistance
Version: symmetric pin layout
Temperature range up to 85°C
1500Vrms across opened contacts

Footprint

2) see footnote below

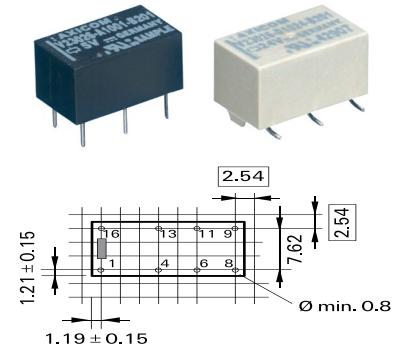
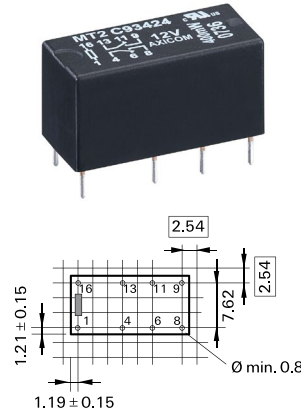

| Applications | Communication equipment Linecard application Measurement and control equipment | Automotive equipment CAN bus Imobilizer |
|--------------------------------------|--|---|
| Contact Data | | |
| Contact arrangement | 2 form C, 2 CO Bifurcated contacts | 1 form C, 1 CO Bifurcated contacts |
| Rated voltage | 250VAC/220VDC | 150VAC/125VDC |
| Rated current | 2A | 1A |
| Switching power / Max. break | 60W/62.5VA | 30W/60VA |
| Min. recommended contact load | 100µV/1µA | 100µV/1µA |
| Initial contact resistance | <70mΩ | <50mΩ |
| Coil Data | | |
| Magnetic system | Non polarized | Polarized |
| Rated coil voltage | 3 to 48VDC | 3 to 24VDC |
| Rated coil power | 150 to 550mW/-/- | 65 to 130mW/30 to 130mW/70 to 200mW |
| DC coil/bistable 1 coil/2 coils | | |
| Dielectric Strength | | |
| Initial dielectric strength | | |
| between open contacts | 750Vrms | 500Vrms |
| between contact and coil | 1000Vrms | 1500Vrms |
| between adjacent contacts | 750Vrms | |
| Initial surge withstand voltage | | |
| between open contacts | 1500V | |
| between contact and coil | 1500V | 2500V |
| between adjacent contacts | 1500V | |
| Isolation 100/900MHz | -31.8/-14.2dB | -30.0/-18.0dB |
| Insertion loss 100/900MHz | -0.02/-0.97dB | -0.12/-1.90dB |
| Volt. standing wave ratio 100/900MHz | 1.03/1.31 | 1.06/1.75 |
| Capacitance | | |
| between open contacts | max. 2pF | max. 5pF |
| Other Data | | |
| Ambient temperature (max.) | -55 to +85°C | -40 to +85°C |
| Category of environmental protection | IP67/RTIII | IP67/RTIII |
| Terminal type | THT | THT, SMT |
| Dimension (lwh) | 20.2x10x11mm | 13x7.6x6.9mm |
| Link to datasheet | Axicom MT2 | Axicom P1 V23026 |

1) Recommended minimum load indication for contact material: AU and gold plated: 1mA at 6VDC; AgNi0.15 and AgNi90/10: 10mA at 12VDC; AgCdO and AgSnO₂: 100mA at 12VDC. Please contact technical support for detailed technical data.

2) Footprint images are representative. For a complete selection, refer to the TE data sheet via the link above.

Signal Relays

Relays, Contactors & Circuit Breakers

Key Features

Axicom REED DIP/SIL

Direct driving with TTL signals
 Ultrasonic cleanable
 High switching speed
 Clamping diode
 Electrostatic shield

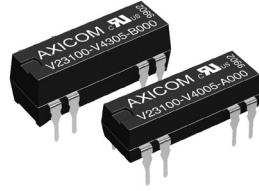

TSC

Designed for thermostat, modem
 Computer peripherals, video
 recording and security application
 Low coil power requirements
 IC compatibility



OUAZ/T81

Gold overlay silver palladium alloy
 contact suitable for low loads
 High density available on PCB due to
 small size
 2.54mm terminal pitch same as IC
 socket terminal pitch
 Sensitive and standard coils



Footprint

2) see footnote below

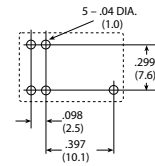
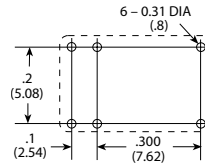
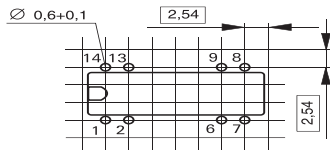

| Applications | Incircuit tester Measuring and control systems Alarm and security equipment | Telecommunications Office machine | Telecommunications Logic and process control Vending machines |
|--------------------------------------|---|--------------------------------------|---|
| Contact Data | | | |
| Contact arrangement | 1 form A, 1 NO 2 form A, 2 NO 1 form C, 1 CO Reed contacts | 1 form C, 1 CO | 1 form C, 1 CO 1 form A, 1 NO |
| Rated voltage | 175 to 200VAC/VDC | 120VAC, 30VDC | 120VAC/24VDC |
| Rated current | 0.25 to 0.5A | 1A | 1A |
| Switching power / Max. break | 3 to 10W | 120VA, 24W | 120VA, 30W |
| Min. recommended contact load | 10μV/1μA | 1mA at 1VDC | 1mA at 1VDC |
| Initial contact resistance | <150mΩ | 50mΩ at 100mA, 6VDC | |
| Coil Data | | | |
| Magnetic system | Non polarized | DC, sensitive | DC, sensitive |
| Rated coil voltage | 5 to 24VDC | 3 to 24VDC | 5 to 24VDC |
| Rated coil power | 50 to 300mW/-/- DC coil/bistable 1 coil/2 coils | 150, 300mW | 200, 450mW |
| Dielectric Strength | | | |
| Initial dielectric strength | | | |
| between open contacts | 140 to 175Vrms | 400Vrms | 500Vrms |
| between contact and coil | 500vdc | 1000Vrms | 1000Vrms |
| between adjacent contacts | 500vdc | | |
| Initial surge withstand voltage | | | |
| between open contacts | | | |
| between contact and coil | | 1500Vp (10/160μs) | 1500Vp (10/160μs) |
| between adjacent contacts | | | |
| Isolation 100/900MHz | | | |
| Insertion loss 100/900MHz | | | |
| Volt. standing wave ratio 100/900MHz | | | |
| Capacitance | | | |
| between open contacts | max. 1pF | | |
| Other Data | | | |
| Ambient temperature (max.) | -20 to +70°C | 40 to +80°C | -40 to +60°C (standard) |
| Category of environmental protection | IP67/RTIII | RTIII/IP67 | RTII, RTIII |
| Terminal type | THT | THT | THT |
| Dimension (lwh) | 19.3x5.7x7.5mm/19.8x5.1x8mm | 12.5x7.5x10mm | 15.4x10.4x11.2mm |
| Link to datasheet | Axicom REED DIP/SIL | TSC | OUAZ/T81 |

1) Recommended minimum load indication for contact material: AU and gold plated: 1mA at 6VDC; AgNi0.15 and AgNi90/10: 10mA at 12VDC; AgCdO and AgSnO₂: 100mA at 12VDC. Please contact technical support for detailed technical data. 2) Footprint images are representative. For a complete selection, refer to the TE data sheet via the link above.



High Frequency Relays

Relays, Contactors & Circuit Breakers

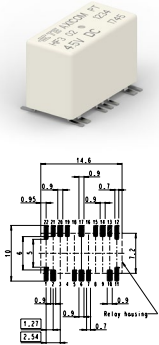
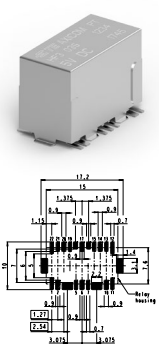
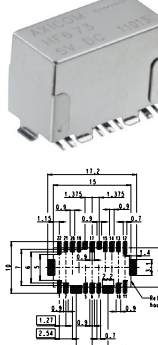
| | Axicom HF3 | Axicom HF3S | Axicom HF6 |
|---|--|--|--|
| Key Features | High performance RF relay/switch for up to 3GHz Low power consumption $\leq 70/140$ mW 50 and 75 Ω version Very small design | High performance RF relay/switch for up to 3GHz Low power consumption $\leq 70/140$ mW 50 and 75 Ω version RF power 100W at 2GHz Very small design | High performance RF relay/switch for up to 6GHz Low power consumption $\leq 70/140$ mW 50 Ω version Very small design |
| Footprint 2) see footnote below |  |  |  |
| Applications | Cable modems and linecards/CATV Measurement and test equipment ATE Satellite/audio/video tuners | Cable modems and linecards/CATV Measurement and test equipment ATE Satellite/audio/video tuners | Measurement and test equipment ATE Wireless base stations and antennas Wireless infrastructure |
| Contact Data | 1 form C, 1 CO Bridge contacts 250VAC/220VDC 2A 60W/62.5VA/50W (2.5GHz) 100 μ V/1 μ A <100m Ω | 1 form C, 1 CO Bridge contacts 250VAC/220VDC 2A 60W/62.5VA/50W (2.5GHz) 100 μ V/1 μ A <100m Ω | 1 form C, 1 CO Bridge contacts 250VAC/220VDC 2A 60W/62.5VA/50W (2.5GHz) 100 μ V/1 μ A <100m Ω |
| Coil Data | Polarized 3 to 24VDC 140mW/70mW/140mW | Polarized 3 to 24VDC 140mW/70mW/140mW | Polarized 3 to 24VDC 140mW/70mW/140mW |
| Dielectric Strength | Initial dielectric strength between open contacts 600Vrms between contact and coil 1000Vrms between adjacent contacts 1000Vrms Initial surge withstand voltage between open contacts 1000Vp between contact and coil 1500Vp between adjacent contacts 1500Vp Capacitance between open contacts max. 1pF | Initial dielectric strength between open contacts 600Vrms between contact and coil 1000Vrms between adjacent contacts 1000Vrms Initial surge withstand voltage between open contacts 1000Vp between contact and coil 1500Vp between adjacent contacts 1500Vp Capacitance between open contacts max. 1pF | Initial dielectric strength between open contacts 600Vrms between contact and coil 1000Vrms between adjacent contacts 1000Vrms Initial surge withstand voltage between open contacts 1000Vp between contact and coil 1500Vp between adjacent contacts 1500Vp Capacitance between open contacts max. 1pF |
| RF Data | 0.1/0.9/3GHz Isolation -80/-72/-DB45 Insertion loss -0.03/0.12/-0.35dB Voltage standing wave ratio (VSWR) 1.05/1.15/1.20 | 0.1/0.9/3GHz Isolation -95/-80/-55dB Insertion loss -0.03/-0.12/-0.30dB Voltage standing wave ratio (VSWR) 1.05/1.10/1.25 | 0.9/3/6GHz Isolation -80/-60/-30dB Insertion loss -0.05/-0.15/-0.80dB Voltage standing wave ratio (VSWR) 1.05/1.10/1.40 |
| Other Data | Ambient temperature (max.) -55 to +85°C Category of environmental protection IP67/RTIII Terminal type SMT Dimension (lwh) 14.6x7.2x10mm | Ambient temperature (max.) -55 to +85°C Category of environmental protection IP67/RTIII Terminal type SMT Dimension (lwh) 15x7.6x10.6mm | Ambient temperature (max.) -55 to +85°C Category of environmental protection IP67/RTIII Terminal type SMT Dimension (lwh) 15x7.6x10.6mm |
| Link to datasheet | Axicom HF3 | Axicom HF3S | Axicom HF6 |

1) Recommended minimum load indication for contact material: AU and gold plated: 1mA at 6VDC; AgNi0.15 and AgNi90/10: 10mA at 12VDC; AgCdO and AgSnO₂: 100mA at 12VDC. Please contact technical support for detailed technical data. 2) Footprint images are representative. For a complete selection, refer to the TE data sheet via the link above.

Solid State Relays

Relays, Contactors & Circuit Breakers

Key Features

Potter & Brumfield SSR

Standard "hockey puck" package
Inverse parallel SCR output
240VAC & 480VAC output types
Zero voltage and random voltage turn-on versions
4,000Vrms optical isolation
Cover design with anti-rotation barriers
1 Form A (SPST-NO)



PCB mount not applicable.
Visit [TE.com](https://www.te.com) for more information

Potter & Brumfield SSRD

Two independent AC output solid state relays
Standard "hockey puck" package
Inverse parallel SCR output
4000Vrms optical isolation
Quick connect style termination
2 Form A (2 SPST-NO)



PCB mount not applicable.
Visit [TE.com](https://www.te.com) for more information

Potter & Brumfield SSRT

Standard "hockey puck" package
TRIAC Output
4,000Vrms optical isolation
Cover design with anti-rotation barriers
1 Form A (SPST-NO)



PCB mount not applicable.
Visit [TE.com](https://www.te.com) for more information

Typical Applications

Industrial machinery
HVAC
Building controls

Industrial machinery
HVAC
Building controls

Industrial machinery
HVAC
Building controls

Output Data

| | | | |
|--|-------------------------|-------------|-------------|
| Load Voltage | 24 - 280VAC/48 - 660VAC | 24 - 280VAC | 24 - 280VAC |
| Repetitive Blocking Voltage | 600VAC/1200VAC | 600VAC | 600VAC |
| Load Current Range | 25A/50A/125A | 25A/40A | 10A/25A |
| Leakage Current (Off-State) | 5mA | 5mA | 5mA |
| On-State Voltage Drop (Max.) | 1.8V | 1.8V | 1.6V |
| Load Power Factor Rating | 0.5 - 1.0 | 0.5 - 1.0 | 0.5 - 1.0 |
| Thermal Resistance, Junction to Case (R _{θJ-C}) (Max.) | 2.35/0.55/0.35 | 2.35/0.86 | 2.4/1.7 |

Input Data (AC/DC)

| | | | |
|--------------------------------------|-----------------------|-------------|-----------------------|
| Control Voltage Range VIN | 90 - 280VAC/3 - 32VDC | 4 - 15VDC | 90 - 280VAC/3 - 32VDC |
| Must Operate Voltage VIN(OP) (Min.) | 90VAC/3VDC | 4VDC | 90VAC/3VDC |
| Must release Voltage VIN(REL) (Min.) | 10VAC/1VDC | 1VDC | 10VAC/1VDC |
| Input Current | 2 - 26mA / 3 - 30mA | 15mA @ 8VDC | 25mA/20mA |

Dielectric Strength

| | | | |
|------------|----------|----------|----------|
| Isolation: | 4000Vrms | 4000Vrms | 4000Vrms |
|------------|----------|----------|----------|

Other Data

| | | | |
|-----------------------|------------------|-------------------|----------------|
| Dimensions | 46.5x57.8x43.4mm | 44.5x57.8x30.15mm | 45x57.5x36.5mm |
| Operating Temperature | -30 to +80°C | -30 to +80°C | -30 to +80°C |
| Mounting | Panel | Panel | Panel |
| UL File No | E29244 | E29244 | E29244 |

Link to datasheet

[Potter & Brumfield SSR](#)

[Potter & Brumfield SSRD](#)

[Potter & Brumfield SSRT](#)

1) Recommended minimum load indication for contact material: AU and gold plated: 1mA at 6VDC; AgNi0.15 and AgNi90/10: 10mA at 12VDC; AgCdO and AgSnO₂: 100mA at 12VDC. Please contact technical support for detailed technical data.

Solid State Relays

Relays, Contactors & Circuit Breakers

Key Features

Potter & Brumfield SSRDC

Standard "hockey puck" package
200VDC FET output
12A, 25A and 40A load current options
1500VDC optical isolation
Cover design with anti-rotation barriers
1 Form A (SPST-NO)



PCB mount not applicable.
Visit [TE.com](https://www.te.com) for more information

Potter & Brumfield SSRK

10-30A DIN mount Solid State Relay with integrated heat sink
Narrow 22.5mm design
Inverse parallel SCR output
240VAC & 600VAC output types
4,000Vrms optical isolation
1 Form A (SPST-NO)



PCB mount not applicable.
Visit [TE.com](https://www.te.com) for more information

Potter & Brumfield SSRM

45A-65A DIN mount Solid State Relay with integrated heat sink
44.5mm design
Inverse parallel SCR output
600VAC output type
4,000Vrms optical isolation
1 Form A (SPST-NO)



PCB mount not applicable.
Visit [TE.com](https://www.te.com) for more information

Typical Applications

Material handling
Trains
Construction equipment

Industrial machinery
HVAC
Building controls

Industrial machinery
HVAC
Building controls

Output Data

| | | | |
|--|----------------|-------------------------|-------------|
| Load Voltage | 200VDC | 24 - 280VAC/48 - 660VAC | 48 - 660VAC |
| Repetitive Blocking Voltage | NA | 600VAC/1200VAC | 1200VAC |
| Load Current Range | 10 A/25 A/40 A | 10A/20A/30A | 45A/55A/65A |
| Leakage Current (Off-State) | 12mA | 5mA | 1mA |
| On-State Voltage Drop (Max.) | 2.83VDC | 1.8V/1.6V | 1.7V |
| Load Power Factor Rating | NA | 0.5 - 1.0 | 0.5 - 1.0 |
| Thermal Resistance, Junction to Case (R _{θJ-C}) (Max.) | 0.7/0.7/0.5 | - | - |

Input Data (AC/DC)

| | | | |
|--------------------------------------|-----------|------------------------|-----------------------|
| Control Voltage Range VIN | 3 - 32VDC | 90 - 280VAC/3 - 32VDC | 90 - 140VAC/4 - 32VDC |
| Must Operate Voltage VIN(OP) (Min.) | 3.5VDC | 90VAC/3VDC | 90VAC/3VDC |
| Must release Voltage VIN(REL) (Min.) | 1VDC | 10VAC/1VDC | 10VAC/1VDC |
| Input Current | 30mA | 7.5mA - 16mA/18 - 30mA | 15mA/14 - 30mA |

Dielectric Strength

| | | | |
|------------|---------|----------|----------|
| Isolation: | 1500VDC | 4000Vrms | 4000Vrms |
|------------|---------|----------|----------|

Other Data

| | | | |
|-----------------------|----------------|-------------------|-------------------|
| Dimensions | 45x57.8x43.4mm | 22.5x82.3x111.5mm | 22.5x76.2x109.2mm |
| Operating Temperature | -30 to +80°C | -30 to +80°C | -40 to +80°C |
| Mounting | Panel | Din Rail | Din Rail |
| UL File No | E29244 | E29244 | E29244 |

Link to datasheet

[Potter & Brumfield SSRDC](#)

[Potter & Brumfield SSRK](#)

[Potter & Brumfield SSRM](#)

1) Recommended minimum load indication for contact material: AU and gold plated: 1mA at 6VDC; AgNi0.15 and AgNi90/10: 10mA at 12VDC; AgCdO and AgSnO₂: 100mA at 12VDC. Please contact technical support for detailed technical data.

Solid State Relays

Relays, Contactors & Circuit Breakers

Key Features

Potter & Brumfield OACM

Slim Solid State AC Output Module
Color coded by function - black
4000Vrms optical isolation
Compatible with 2IO series mounting boards
1 Form A (SPST-NO)

Potter & Brumfield IDCM

Slim Solid State DC Input Module
Color coded by function - white
4000Vrms optical isolation
Compatible with 2IO series mounting boards
1 Form A (SPST-NO)

Potter & Brumfield ODCM

Slim Solid State AC Output Module
Color coded by function - red
4000Vrms optical isolation
Compatible with 2IO series mounting boards
1 Form A (SPST-NO)

Footprint

2) see footnote below

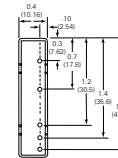
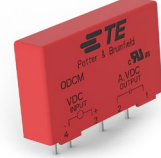
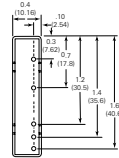
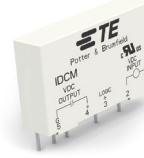
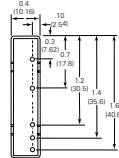

Typical Applications

Industrial machinery
HVAC
Building controls

Industrial machinery
HVAC
Building controls

Industrial machinery
HVAC
Building controls

Output Data

| | | | |
|--|-------------|--------|--------|
| Load Voltage | 24 - 280VAC | 30VDC | 60VDC |
| Repetitive Blocking Voltage | 600VAC | - | - |
| Load Current Range | 3A/5A | 50mA | 3A |
| Leakage Current (Off-State) | 5mA | 10uA | 0.5mA |
| On-State Voltage Drop (Max.) | 1.6VAC | 0.2VDC | 1.5VDC |
| Load Power Factor Rating | - | - | - |
| Thermal Resistance, Junction to Case (R _{θJ-C}) (Max.) | - | - | - |

Input Data (AC/DC)

| | | | |
|--------------------------------------|----------------------|----------------------|------------------|
| Control Voltage Range VIN | 3 - 8VDC / 3 - 15VDC | 3 - 32VDC/10 - 60VDC | 5VDC/15VDC/24VDC |
| Must Operate Voltage VIN(OP) (Min.) | 3VDC | 3VDC/10VDC | 3VDC/9VDC/18VDC |
| Must release Voltage VIN(REL) (Min.) | 1VDC | 1VDC/1VDC | 1VDC |
| Input Current | 8mA | 10mA | 20mA |

Dielectric Strength

| | | | |
|------------|----------|----------|----------|
| Isolation: | 4000Vrms | 4000Vrms | 4000Vrms |
|------------|----------|----------|----------|

Other Data

| | | | |
|-----------------------|------------------|------------------|------------------|
| Dimensions | 43.5x10.3x25.5mm | 43.5x10.3x25.5mm | 43.5x10.3x25.5mm |
| Operating Temperature | -30 to 100°C | -30 to 100°C | -30 to 100°C |
| Mounting | PCB | PCB | PCB |
| UL File No | E29244 | E29244 | E29244 |

Link to datasheet

[Potter & Brumfield OACM](#)

[Potter & Brumfield IDCM](#)

[Potter & Brumfield ODCM](#)

1) Recommended minimum load indication for contact material: AU and gold plated: 1mA at 6VDC; AgNi0.15 and AgNi90/10: 10mA at 12VDC; AgCdO and AgSnO₂: 100mA at 12VDC. Please contact technical support for detailed technical data. 2) Footprint images are representative. For a complete selection, refer to the TE data sheet via the link above.

Circuit Breakers

Relays, Contactors & Circuit Breakers

Key Features

Potter & Brumfield W28

Thermal Overload / Trip Free Operation
 Replaces slow blow glass cartridge fuse and holder
 Button provides visible trip indication
 Push-to-reset
 Snap-in mounting
 UL 1077, CSA, VDE, CCC (16A/20A not VDE)



PCB mount not applicable.
 Visit [TE.com](https://www.te.com) for more information

Potter & Brumfield W23/W31

Thermal Overload / Trip Free Operation
 Toggle or Push/Pull Actuation
 Cannot be reset against overload
 On/Off switching option
 UL 1077, CSA



PCB mount not applicable.
 Visit [TE.com](https://www.te.com) for more information

| Typical Applications | HVAC (Transformers), General Aviation, Medical, Marine Power Supplies, Lighting, Surge Protection Audio, Pool and Spa, Appliances, Industrial Controls | Generators, General Aviation, Medical, Marine Power Supplies, Lighting, Surge Protection Audio, Pool and Spa, Appliances, Industrial Controls |
|------------------------------|--|---|
| Operational Data | | |
| Type | Thermal | Thermal |
| Number of Poles | 1 | 1 |
| Circuit function | Series trip | Series trip |
| Ambient temperature (max.) | -20 to +60 °C | -20 to +65°C |
| Terminal type | Standard quick connect .250in x .032in | #8-32 screw |
| Mounting | Snap-in | Thru-hole 3/8"-24 threaded bushing |
| Manual operation Actuator | Push-to-reset | Push/pull W23 and toggle W31 |
| Dimension L*W*H | 39.0 x 15.9 x 13.7mm | 40.6x17.5x35.2mm |
| Electrical Data | | |
| Dielectric strength | 1500Vrms | 1500Vrms |
| Insulation Resistance | | |
| Max Operating Voltages | 32VDC 250VAC, 50/60Hz | 50VDC 240VAC to (400Hz) |
| Rated current | 0.5A to 20A | 1A to 50A |
| Interrupt capacity | 1,000 amps at 250VAC, 50/60 Hz. and 32VDC in accordance with UL standard 1077. | With 4X Max. Series Fuse Protection 0.5-50 amp models – 1000 amps at 240VAC. 30-50 amp models – 1000 amps at 50VDC. Without 4X Max. Series Fuse Protection 0.5-25 amp models – 2000 amps at 50VDC. 10-20 amp models – 2000 amps at 120VAC Continuously carry 100% of rating, may trip between 101% and 134% of rating at 25°C. Must trip at 135% in one hour. |
| Calibration | Will continuously carry 100% of rating. 3-20 amp models - may trip between 101% and 134%, but must trip at 135% of rating within one hour at +25°C. 0.25-2 amp models - may trip between 101% and 174%, but must trip at 175% of rating within one hour at +25°C. | |
| Resettable Overload Capacity | Six times rated current for 0.25 through 2 amp models. Ten times rated current for 3 through 20 amp models. | Ten times rated current. |
| Reset Time | 180 seconds max. for 0.25 through 2 amp models. 5 to 30 seconds for 3 through 20 amp models. | |
| Accessories | Protective boot, push-on lockwasher | Hex nut, lockwasher, knurl nut |
| Link to datasheet | Potter & Brumfield W28 | Potter & Brumfield W23/W31 |

1) Recommended minimum load indication for contact material: AU and gold plated: 1mA at 6VDC; AgNi015 and AgNi90/10: 10mA at 12VDC; AgCdO and AgSnO₂: 100mA at 12VDC. Please contact technical support for detailed technical data. 2) Footprint images are representative. For a complete selection, refer to the TE data sheet via the link above.

Circuit Breakers

Relays, Contactors & Circuit Breakers

Key Features

Potter & Brumfield W33

Thermal overload/trip free Operation
Optional indicator lamp
Optional auxiliary switch
Combines on/off switching and circuit protection in a single unit
UL 1077, CSA



PCB mount not applicable.
Visit [TE.com](https://www.te.com) for more information

Potter & Brumfield W51

Thermal overload/trip free operation
Rocker actuated with switch overload sensing
Optional indicator lamp
Combines power switching and circuit protection in a single unit
Compact design
PCB termination options
UL1077, cUL, VDE, CCC



PCB mount not applicable.
Visit [TE.com](https://www.te.com) for more information

Potter & Brumfield W54

Thermal overload/trip free operation
Push to reset
Visual trip indication
Multiple termination options
UL 1077, UL 1500, cUL, VDE, CCC, CSA. (>30A not UL1500 or CSA) (>20A not VDE)



PCB mount not applicable.
Visit [TE.com](https://www.te.com) for more information

Typical applications

Generators, General Aviation, Medical, Marine
Power Supplies, Lighting, Surge Protection
Audio, pool and spa, appliances, Industrial controls

Generators, General Aviation, Medical, Marine
Power Supplies, Lighting, Surge Protection
Audio, pool and spa, appliances, Industrial controls

Generators, general aviation, medical, marine
Power supplies, lighting, surge protection
Audio, pool and spa, appliances, Industrial controls

Operational Data

| | | | |
|----------------------------|--|--|--|
| Type | Thermal | Thermal | Thermal |
| Number of Poles | 1-2 | 1 | 1 |
| Circuit function | Series trip both poles; series trip 1 pole/switch only 1 pole; switch only 2 poles | Series trip | Series trip |
| Ambient temperature (max.) | -20 to +65 °C | 0°C to + 60 °C for 10-20A models 0°C to + 50 °C for 5-8A models | 0 to 60 °C |
| Terminal type | Standard quick connect 250in x .032in and solder option | Standard quick connect 250in x .032in/solder option/PCB | Standard quick connect 250in x .032in and #8-32 screw 3/8"-24, M11-1.0, M12-1.0 threaded bushing |
| Mounting | Snap-in | Snap-in, PCB | |
| Manual operation Actuator | Rocker | Rocker | Push-to-reset |
| Dimension L*W*H | 43.8 x 24.9 x 48.0mm | 21.8 x 15.2 x 32.0mm | 31.0 x 14.6 x 35.0mm (W54) 22.6 x 14.6 x 29.2mm (W57) |

Electrical Data

| | | | |
|-----------------------------|---|--|--|
| Dielectric strength | 2000Vrms | 1500VAC | 1500VAC |
| Insulation Resistance | | 100M Ω | 100MΩ |
| Max Operating Voltages | 50VDC 250VAC | 50VDC 125/250VAC (model dependent) | 50VDC 250VAC |
| Rated current | 2A to 20A | 5A to 20A | 5A to 40A |
| Interrupt capacity | 1000A at 50VDC, 250VAC/60Hz and 125/250VAC 400Hz; 1500A at 25/250VAC/60Hz | 1,000 amps in accordance with UL standard 1077 | 1,000 amps in accordance with UL standard 1077 |
| Calibration | Will continuously carry 100% of rating. May trip between 101% and 134%, but must trip at 135% of rating within one hour at +25°C 150% for 5-8A models | Will continuously carry 100% of rating. May trip between 101% and 134%, but must trip at 135% of rating within one hour at +25°C. 150% for 5-8A models | Will continuously carry 100% of rating. May trip between 101% and 134%, but must trip at 135% of rating within one hour at +25°C |
| Resettable OverloadCapacity | Ten times rated current | Ten times rated current. Switch Endurance Cycling: Typically 6,000 operations at 100% of rating | Ten times rated current. |
| Reset Time | | 60 Seconds | 60 Seconds |

Accessories

Protective boot, knurl nut, hex nut, lockwasher, nameplate

Link to datasheet

[Potter & Brumfield W33](#)

[Potter & Brumfield W51](#)

[Potter & Brumfield W54](#)

1) Recommended minimum load indication for contact material: AU and gold plated: 1mA at 6VDC; AgNi0.15 and AgNi90/10: 10mA at 12VDC; AgCdO and AgSnO₂: 100mA at 12VDC. Please contact technical support for detailed technical data.

Circuit Breakers

Relays, Contactors & Circuit Breakers

Key Features

Potter & Brumfield W57

Thermal overload/trip free operation
Push to reset
Compact design
Cannot be manually tripped
PCB termination options
UL 1077, UL 1500, cUL, VDE, CCC.
(3A,4A,20A no VDE)



PCB mount not applicable.
Visit [TE.com](https://www.te.com) for more information

Potter & Brumfield W58

Thermal overload/trip free operation
Push to reset
Cannot be manually tripped
Visual trip indication
UL 1077, UL 1500, CSA. (30A not UL or CSA)



PCB mount not applicable.
Visit [TE.com](https://www.te.com) for more information

Potter & Brumfield W6/W9

Magnetic hydraulic actuation/trip-free operation
Several delay curve options
Fungus and moisture resistant
UL 1077, UL 1500, CSA, VDE



PCB mount not applicable.
Visit [TE.com](https://www.te.com) for more information

Applications

Generators, general aviation, medical, marine
Power supplies, lighting, surge protection
Audio, pool and spa, appliances, Industrial controls

Generators, general aviation, medical, marine
Power supplies, lighting, surge protection
Audio, pool and spa, appliances, Industrial controls

HVAC (transformers), general aviation, medical, marine
Power supplies, lighting, surge protection
Audio, pool and spa, appliances, Industrial controls

Operational Data

| | | | |
|----------------------------|--|---|--|
| Type | Thermal | Thermal | Magnetic/hydraulic |
| Number of Poles | 1 | 1 | 1-4 |
| Circuit function | Series trip | Series trip | Series trip |
| Ambient temperature (max.) | 0 to 60°C | -25 to 65°C | -40 to +85 °C |
| Terminal type | Standard quick connect .250in x .032in and #8-32 screw and PCB option | Standard quick connect .250in x .032in and #8-32 screw | W6-Standard Quick Connect .250in x .032in and #8-32 or #10/32 screw. W9- #10/32 stud terminations |
| Mounting | 3/8"-24, M11-1.0, M12-1.0 threaded bushing | 7/16"-28, 15/32"-32, 3/8"-24 threaded bushing" | 6-32, M3 tapped holes |
| Manual operation Actuator | Push-to-reset | Push-to-reset | Toggle |
| Dimension L*W*H | 31.0 x 14.6 x 35.0mm (W54) 22.6 x 14.6 x 29.2mm (W57) | 34.9 x 16.8 x 34.9mm | 41.7 x 19.0 x 50.8mm (W6 per pole) 46.9 x 19.0 x 63.5mm (W9 per pole) |

Electrical Data

| | | | |
|------------------------------|--|--|---|
| Dielectric strength | 1500VAC | 1500Vrms | 50/60 Hz, 1500V: DC, 1100V |
| Insulation Resistance | | | 100 megohms at 500VDC |
| Max Operating Voltages | 50VDC, 250VAC 50/60 Hz | 50VDC, 250VAC | 65VDC, 277VAC, 480VAC - 3Ø wye |
| Rated current | 3A to 20A | 0.5A to 30A | 0.20A to 50A |
| Interrupt capacity | 1000 amps in accordance with UL standard 1077 | 2000 amps at 50VDC (0.5 - 30 amp models) 1000 amps at 250VAC (0.5 - 30amp models). Note: 30 amp model not UL or CSA | up to 5000A with UL 1077, CSA, VDE. Up to 3000A for UL 1500 |
| Calibration | Will continuously carry 100% of rating. May trip between 101% and 134%, but must trip at 135% of rating within one hour at +25°C | Breaker will continuously carry 100% of rated load. It may trip between 101% and 145% of rated load, but must trip at 145% at 25°C | Breakers will hold 100% rated current. May trip between 101% and 124% rated load (134% for AC/DC units) Must trip at 125% rated load (135% for AC/DC units) |
| Resettable Overload Capacity | Ten times rated current | Ten times rated current | Ten times rated current |
| Reset Time | 60 Seconds | | 60 Seconds |

Accessories

Protective boot, knurl nut, hex nut, lockwasher, nameplate

Protective boot, knurl nut, hex nut, lockwasher

Toggle guard (W6 only)

Link to datasheet

[Potter & Brumfield W57](#)

[Potter & Brumfield W58](#)

[Potter & Brumfield W6/W9](#)

1) Recommended minimum load indication for contact material: AU and gold plated: 1mA at 6VDC; AgNi0.15 and AgNi90/10: 10mA at 12VDC; AgCdO and AgSnO₂: 100mA at 12VDC. Please contact technical support for detailed technical data.

Transformers

Relays, Contactors & Circuit Breakers

Key Features

4000 SERIES WIRE LEAD CLASS II CONTROL TRANSFORMERS

5VA to 75VA
 UL 5085-3, formerly UL 1585
 Inherently/non-inherently energy limited
 Wire lead terminations
 Custom specification/design available

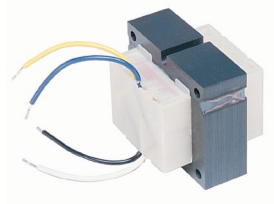

Visit TE.com for more information

4000 SERIES QUICK CONNECT CLASS II CONTROL TRANSFORMERS

5VA to 75VA
 UL 5085-3, formerly UL 1585
 Inherently/non-inherently energy limited
 Quick connect terminals
 Custom specification/design available

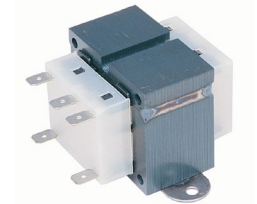

Visit TE.com for more information

Typical Applications

HVAC
 Industrial and residential
 Motor control

HVAC
 Industrial and residential
 Motor control

Specifications

| | | |
|-----------------------|--|---|
| Primary Voltage- AC | 120, 208, 240, 277, 380, 415, 480, 575 | 120, 208, 240, 277, 380, 415, 480, 575 |
| Secondary Voltage- DC | 12 or 24 | 12 or 24 |
| Insulation Class | UL Class B (130°C) | UL Class B (130°C) |
| Wire Size | Standard 18 AWG stranded, 12in | N/A |
| QC size | N/A | standard .250in x .032in |
| Terminations | Same side - opposite side | Type BB Same side Type AB Opposite side Type AE Laydown |
| Frequency | 50/60 Hz | 50/60 Hz |
| Mounting Options | Type K Foot Mount Type G Panel Mount Plate Mount | Type K Foot Mount Type G Panel Mount Plate Mount |

Other Data

| | | |
|------------------------------|---|--|
| Secondary Fusing Requirement | 60VA-75VA non-inherently energy limited | Internal fuse or integral circuit breaker 75VA standard models come with integral circuit breaker |
| Shielding | Internal fuse or integral circuit breaker | |
| Dielectric Strength | 75VA standard models come with integral circuit breaker | |

Link to datasheet

[4000 SERIES WIRE LEAD CLASS II CONTROL TRANSFORMERS](#)

[4000 SERIES QUICK CONNECT CLASS II CONTROL TRANSFORMERS](#)

1) Recommended minimum load indication for contact material: AU and gold plated: 1mA at 6VDC; AgNi0.15 and AgNi90/10: 10mA at 12VDC; AgCdO and AgSnO₂: 100mA at 12VDC. Please contact technical support for detailed technical data.

Transformers

Relays, Contactors & Circuit Breakers

Key Features

4700 SERIES GENERAL PURPOSE POWER TRANSFORMERS

60VA to 150VA
 UL 5085-1,-2 formerly UL 50
 Non-fused
 Wire leads or quick connects
 Custom specification/design available

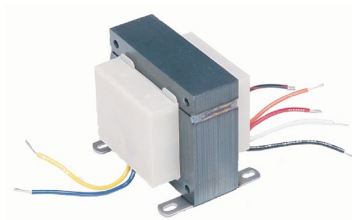

Visit [TE.com](https://www.te.com) for more information

4900 SERIES PRINTED CIRCUIT MOUNT POWER TRANSFORMERS

1.1VA to 36VA
 UL 5085-1,-2 formerly UL 506
 Drop in replacement
 Split bobbin design
 Signal or dual primary voltage
 Custom specification/design available



Visit [TE.com](https://www.te.com) for more information

| Applications | HVAC Industrial Motor control | Industrial controls, garage door openers small power supplies, control boards lighting/monitoring controls, vending machines |
|------------------------------|--|--|
| Specifications | | |
| Primary Voltage- AC | 120, 208, 240, 230, 277, 460, 480, 575 | Single 115VAC, 6-pin Dual 115/230VAC, 8-pin |
| Secondary Voltage- DC | 24 | Series 10-120VCT Parallel 6-60VAC |
| Insulation Class | UL Class B (130°C) | UL Class B (130°C) |
| Wire Size | Standard 18 AWG stranded, 12in | N/A |
| QC size | Standard .250in x .032in | N/A |
| Terminations | Type BB same side Type AB opposite side | PCB through hole design |
| Frequency | 50/60 Hz | 50/60 Hz |
| Mounting Options | Type K foot mount | PCB through hole design |
| Other Data | | |
| Secondary Fusing Requirement | | |
| Shielding | | Electrostatic shielding not required due to split bobbin |
| Dielectric Strength | | 1500Vrms |
| Link to datasheet | 4700 SERIES GENERAL PURPOSE POWER TRANSFORMERS | 4900 SERIES PRINTED CIRCUIT MOUNT POWER TRANSFORMERS |

1) Recommended minimum load indication for contact material: AU and gold plated: 1mA at 6VDC; AgNi0.15 and AgNi90/10: 10mA at 12VDC; AgCdO and AgSnO₂: 100mA at 12VDC. Please contact technical support for detailed technical data.

te.com

© 2019 TE Connectivity. All Rights Reserved.

Axicom, Potter & Brumfield, SCHRACK, TE, TE Connectivity, and TE Connectivity (logo) are trademarks. All other logos, products and/or company names referred to herein might be trademarks of their respective owners.

While TE has made every reasonable effort to ensure the accuracy of the information in this brochure, TE does not guarantee that it is error-free, nor does TE make any other representation, warranty or guarantee that the information is accurate, correct, reliable or current. TE reserves the right to make any adjustments to the information contained herein at any time without notice. TE expressly disclaims all implied warranties regarding the information contained herein, including, but not limited to, any implied warranties of merchantability or fitness for a particular purpose. The dimensions in this catalog are for reference purposes only and are subject to change without notice. Specifications are subject to change without notice. Consult TE for the latest dimensions and design specifications.

1-1773969-4 02/20 JN

X-ON Electronics

Largest Supplier of Electrical and Electronic Components

Click to view similar products for [General Purpose Relays](#) category:

Click to view products by [TE Connectivity](#) manufacturer:

Other Similar products are found below :

[JVN1AF-4.5V-F](#) [PCN-105D3MHZ](#) [5JO-10000S-SIL](#) [5JO-1000CD-SIL](#) [5JO-400CD-SIL](#) [LY2S-AC220/240](#) [LYQ20DC12](#) [6031007G](#)
[6131406HQ](#) [6-1393099-8](#) [6-1393122-4](#) [6-1393123-2](#) [6-1393767-1](#) [6-1393843-7](#) [6-1415012-1](#) [6-1419102-2](#) [6-1423698-4](#) [6-1608051-6](#) [6-1608067-0](#) [6-1616170-6](#) [6-1616248-2](#) [6-1616282-3](#) [6-1616348-2](#) [6-1616349-9](#) [6-1616350-1](#) [6-1616350-8](#) [6-1616358-7](#) [6-1616359-9](#) [6-1616360-9](#) [6-1616931-6](#) [6-1617039-1](#) [6-1617052-1](#) [6-1617090-2](#) [6-1617090-5](#) [6-1617347-5](#) [6-1617353-3](#) [6-1617801-8](#) [6-1618107-9](#) [6-1618248-4](#) [CX-4014](#) [MAHC-5494](#) [MAVCD-5419-6](#) [703XCX-120A](#) [7-1393100-5](#) [7-1393111-7](#) [7-1393767-8](#) [7-1414968-8](#) [7-1419130-3](#) [7-1608047-2](#) [7-1608065-1](#)