

4



3

2

1



THIS DRAWING IS UNPUBLISHED. RELEASED FOR PUBLICATION
 © COPYRIGHT - By - ALL RIGHTS RESERVED.

REVISIONS				
P	LTR	DESCRIPTION	DATE	APVD
G3		REVISED PER ECO-17-004099	24AUG2017	BDA DR
G4		REVISED PER ECO-18-010020	26JUN2018	RS DR

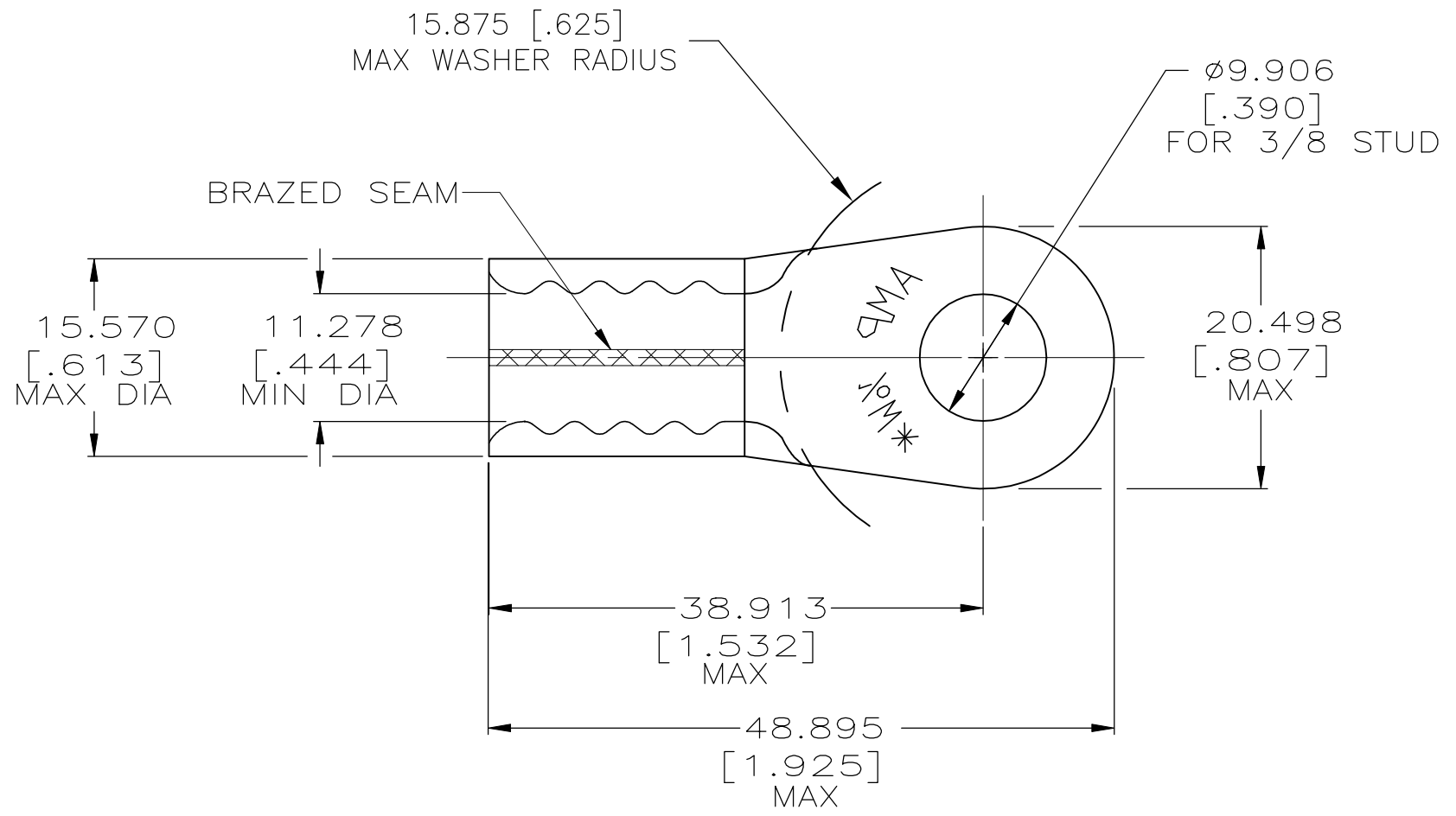
AMP WIRE RANGE	 E13288 Listed
1/0 AWG SOLID OR STRANDED	1/0 AWG STRANDED
 LR7189 Certified	MILITARY P/N AND CLASS 
1/0 AWG SOLID OR STRANDED	MS 20659-118 CLASS 2



 TIN PL 0.00254[.000100] MIN EXT. THK PER ASTM B-545
 2 NOTE DELETED

	50	LOOSE PIECE	CLEANED	COPPER ASTM B-152 1.778±0.076[.070±.003] ANNEALED	2-321868-2
	50	LOOSE PIECE			321868
	QTY.	PACKAGE TYPE	FINISH	MATERIAL	PART NUMBER

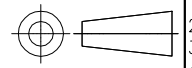
MAX RECOMMENDED OPERATING TEMPERATURE: 170°[338°F]C	THIS DRAWING IS A CONTROLLED DOCUMENT.		DWN DK SCHRUM 8/30/91	 TE Connectivity Ltd.
	VOLTAGE RATING: N/A	DIMENSIONS: INCHES	CHK RD HEIM 9/30/91	
CIRCULAR MIL AREA: 42.4-60.6mm²[83,700-119,500] SOLID OR STRANDED		TOLERANCES UNLESS OTHERWISE SPECIFIED: 0 PLC ± - 1 PLC ± - 2 PLC ± - 3 PLC ± 0.127[.005] 4 PLC ± - ANGLES ± -	APVD AJ KAUFMAN 9/30/91	TERMINAL, RING TONGUE, SOLISTRAND WIRE SIZE 50.0mm² [1/0] AWG
			MATERIAL SEE TABLE	
			APPLICATION SPEC -	SIZE A3
			WEIGHT -	CAGE CODE 00779
			CUSTOMER DRAWING	DRAWING NO C-321868
			SCALE 2:1	RESTRICTED TO -
			SHEET 1 of 1	REV G4

X-ON Electronics

Largest Supplier of Electrical and Electronic Components

Click to view similar products for [Terminals](#) category:

Click to view products by [TE Connectivity](#) manufacturer:

Other Similar products are found below :

[00-054007-01074-6](#) [00-054007-70206-1](#) [00-054007-70210-8](#) [00-054007-70217-7](#) [00-054007-70226-9](#) [00-054007-70228-3](#) [00-054007-70248-1](#) [00-054007-70256-6](#) [00-054007-70301-3](#) [00-054007-70316-7](#) [00-054007-49560-4](#) [00-054007-70209-2](#) [00-054007-70225-2](#) [00-054007-70227-6](#) [00-054007-70231-3](#) [00-054007-70241-2](#) [00-054007-70242-9](#) [00-054007-70244-3](#) [00-054007-70246-7](#) [00-054007-70263-4](#) [00-054007-70288-7](#) [00-054007-70290-0](#) [00-054007-70300-6](#) [00-054007-70304-4](#) [01-2065-1-0216](#) [01-2900-1-04412](#) [00581P0075](#) [600TS-10](#) [60205-1](#) [604200-1](#) [605601-1](#) [60598-1-CUT-TAPE](#) [61314-6-C](#) [61810-3](#) [61-S](#) [61-SN](#) [626-0194](#) [62-NBM-A](#) [62-SN](#) [62-SP](#) [63-S](#) [640179-1](#) [M55155/059I03](#) [M55155/079C01](#) [M55155/099H02](#) [M55155/109H01](#) [M55155/109H02](#) [M55155/12XH05](#) [M55155/16XH02](#) [M55155/29-5S](#)