

© - TE Connectivity. All Rights Reserved.

REVISIONS					
P	LTR	DESCRIPTION	DATE	DWN	APVD
	A1	REVISED	08SEP2020	J.J	W.H

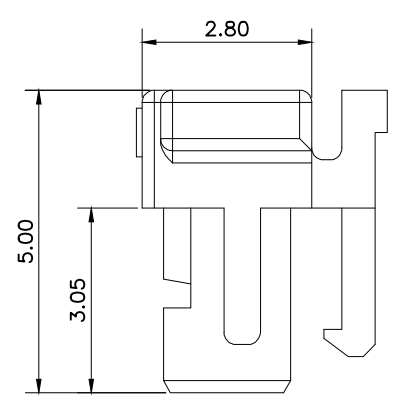
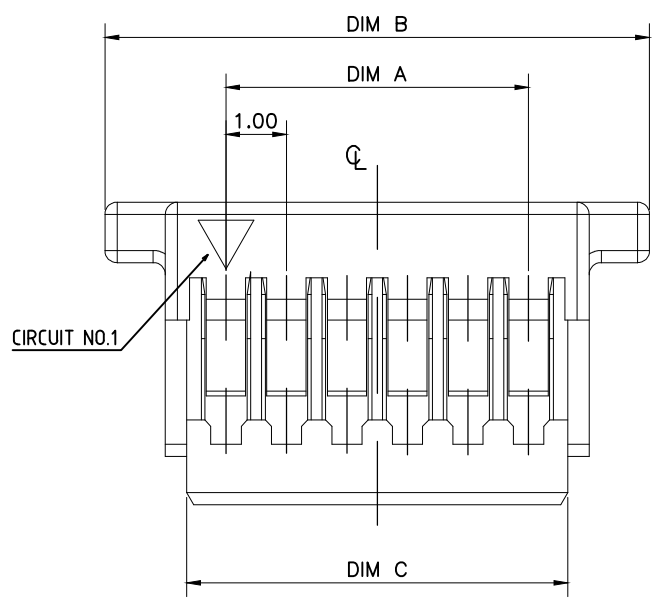
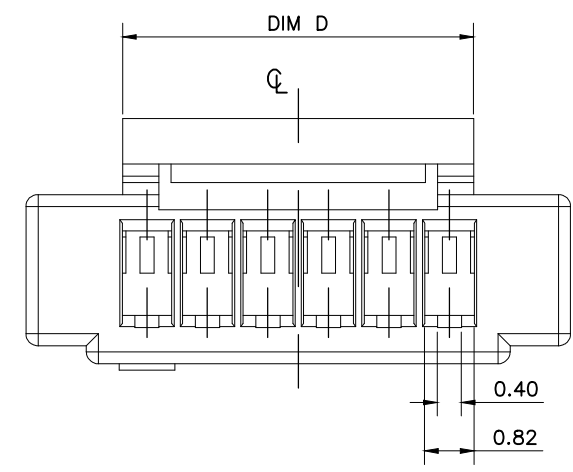

NOTES:
 1. MATERIAL: HALOGEN FREE PLASTIC, UL94V-0.
 2. CABLE CONTACT: 2367199-1

5.8	15.4	18.0	14.0	15	3-2367198-5	1-2367198-5
	14.4	17.0	13.0	14	3-2367198-4	1-2367198-4
	13.4	16.0	12.0	13	3-2367198-3	1-2367198-3
	12.4	15.0	11.0	12	3-2367198-2	1-2367198-2
	11.4	14.0	10.0	11	3-2367198-1	1-2367198-1
	10.4	13.0	9.0	10	3-2367198-0	1-2367198-0
	9.4	12.0	8.0	9	2-2367198-9	2367198-9
	8.4	11.0	7.0	8	2-2367198-8	2367198-8
	7.4	10.0	6.0	7	2-2367198-7	2367198-7
6.4	9.0	5.0	6	2-2367198-6	2367198-6	
4.8	5.4	8.0	4.0	5	2-2367198-5	2367198-5
3.0	4.4	7.0	3.0	4	2-2367198-4	2367198-4
3.0	3.4	6.0	2.0	3	2-2367198-3	2367198-3
DIM.D	DIM.C	DIM,B	DIM.A	POS.NO	COLOR	
					NATURAL BLACK	
					P/N	

THIS DRAWING IS A CONTROLLED DOCUMENT.		DWN Tommy Qian 18DEC2019	TE Connectivity			
DIMENSIONS: mm		CHK Wenke He				NAME
TOLERANCES UNLESS OTHERWISE SPECIFIED:		APVD Wenke He	1.0P WTB CABLE HOUSING WITH LATCH			
0 PLC ± 0.5 1 PLC ± 0.35 2 PLC ± 0.25 3 PLC ± 0.15 4 PLC ± - ANGLES ± 2°		PRODUCT SPEC 108-115169	DRAWING NO			
MATERIAL SEE NOTE		FINISH -	APPLICATION SPEC 114-115031	SIZE A3	CAGE CODE 00779	RESTRICTED TO -
CUSTOMER DRAWING			WEIGHT	DRAWING NO C-2367198	SCALE N/A	SHEET 1 OF 2
			REV A1			

REVISIONS					
P	LTR	DESCRIPTION	DATE	DWN	APVD
	-	SEE SHEET 1	-	-	-

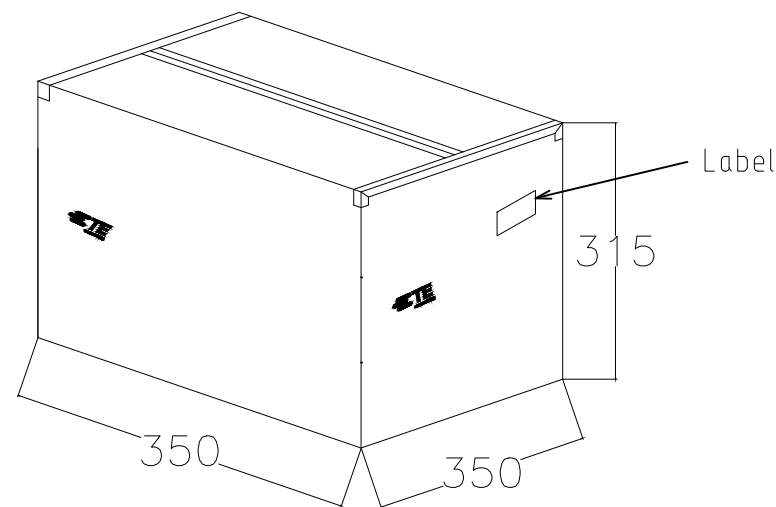
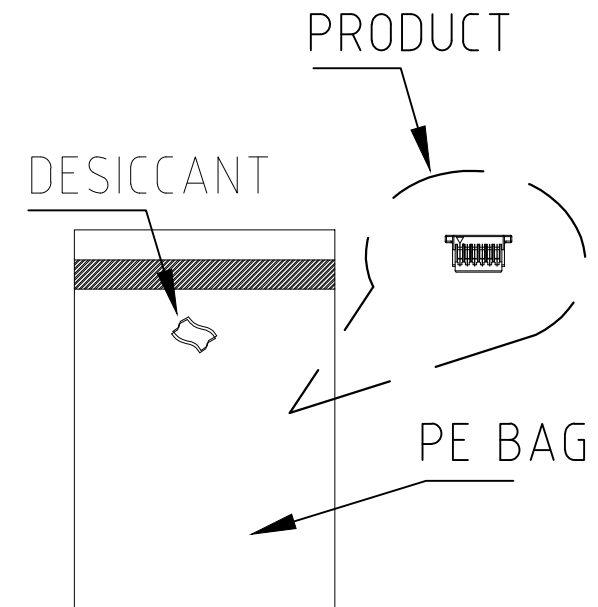
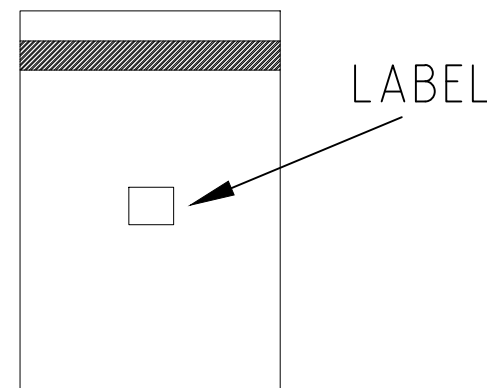
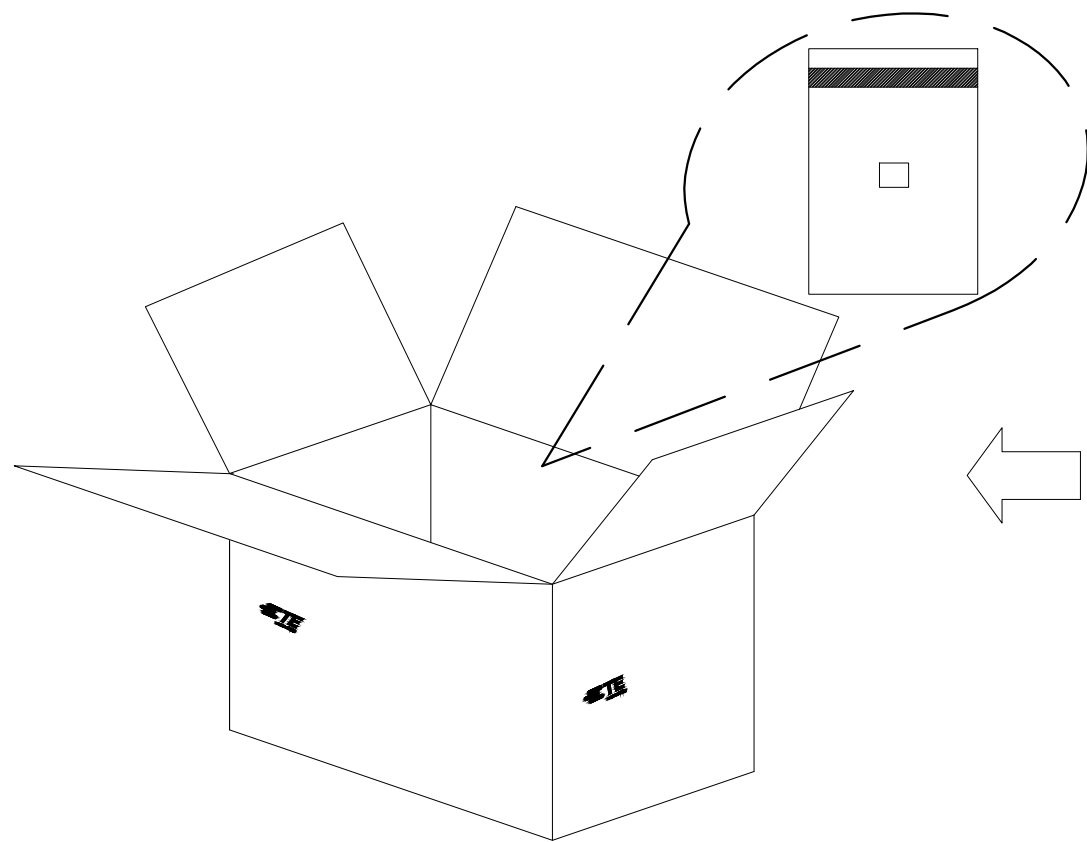

PART NUMBER	PCS/PEG	PCS/CARTON
2-2367198-3	2367198-3	1600
2-2367198-4	2367198-4	1600
2-2367198-5	2367198-5	1600
2-2367198-6	2367198-6	1600
2-2367198-7	2367198-7	1600
2-2367198-8	2367198-8	1600
2-2367198-9	2367198-9	1600
3-2367198-0	1-2367198-0	1600
3-2367198-1	1-2367198-1	1600
3-2367198-2	1-2367198-2	1600
3-2367198-3	1-2367198-3	1600
3-2367198-4	1-2367198-4	1600
3-2367198-5	1-2367198-5	1600

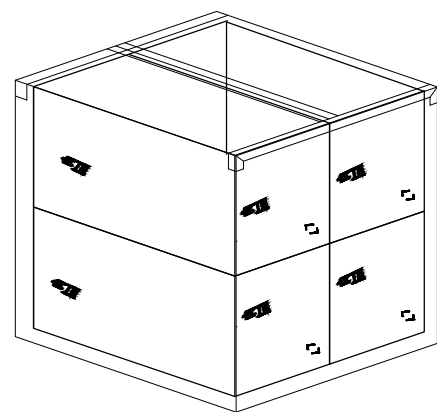

Put 4 small carton into out carton

NOTES:
PACKAGE FOR *-2367198-*

THIS DRAWING IS A CONTROLLED DOCUMENT.		DWN Tommy Qian 18DEC2019	TE Connectivity														
DIMENSIONS: mm		CHK Wenke He				NAME											
TOLERANCES UNLESS OTHERWISE SPECIFIED:		APVD Wenke He	PRODUCT SPEC														
<table border="0"> <tr><td>0 PLC</td><td>± 0.5</td></tr> <tr><td>1 PLC</td><td>± 0.35</td></tr> <tr><td>2 PLC</td><td>± 0.25</td></tr> <tr><td>3 PLC</td><td>± 0.15</td></tr> <tr><td>4 PLC</td><td>± -</td></tr> <tr><td>ANGLES</td><td>± *</td></tr> </table>		0 PLC	± 0.5	1 PLC	± 0.35	2 PLC	± 0.25	3 PLC	± 0.15	4 PLC	± -	ANGLES	± *	108-115169	1.0P WT B CABLE HOUSING WITH LATCH		
0 PLC	± 0.5																
1 PLC	± 0.35																
2 PLC	± 0.25																
3 PLC	± 0.15																
4 PLC	± -																
ANGLES	± *																
MATERIAL SEE NOTE		FINISH -	APPLICATION SPEC 114-115031	SIZE A3	CAGE CODE 00779												
CUSTOMER DRAWING			DRAWING NO C-2367198	RESTRICTED TO -	SCALE N/A												
				SHEET 2 OF 2	REV A1												

X-ON Electronics

Largest Supplier of Electrical and Electronic Components

Click to view similar products for [Headers & Wire Housings](#) category:

Click to view products by [TE Connectivity](#) manufacturer:

Other Similar products are found below :

[892-18-020-10-001101](#) [58102-G61-06LF](#) [582553-1](#) [0009485154](#) [009176003701906](#) [0050291907](#) [LY20-4P-DT1-P1E-BR](#) [02.125.8002.8](#)
[609-3404](#) [61062-3](#) [61082-181009](#) [622-3653LF](#) [63453-116](#) [636-1030](#) [636-1427](#) [636-3427](#) [636-4007](#) [641938-9](#) [641991-4](#) [644827-2](#) [65817-](#)
[010LF](#) [65817-015LF](#) [65863-015LF](#) [66207-023LF](#) [67095-007LF](#) [67601157](#) [68645-018](#) [68648-049](#) [70.362.1628.0](#) [70-4210](#) [70-4226B](#) [70-](#)
[4853B](#) [707-5020](#) [707-5028](#) [71.350.2428.0](#) [71918-208LF](#) [71961-016LF](#) [733-134](#) [733-162](#) [754199-000](#) [760-3052](#) [787-8014-00](#) [79531-3000](#)
[FCN-360C032-B](#) [FCN-367T-T012/H](#) [FCN-723D010/2](#) [80.063.4001.1](#) [800-90-001-10-001000](#) [800-90-010-10-002000](#) [801-43-002-10-013000](#)