

4

3

2

1

THIS DRAWING IS UNPUBLISHED. RELEASED FOR PUBLICATION 20
 © COPYRIGHT 20 BY - ALL RIGHTS RESERVED.

NOTES :

- MATERIALS AND FINISH:
 - HOUSING: HIGH THERMAL PLASTIC
 - CONTACTS: COPPER ALLOY, FINISH: PRE-TIN OVER NICKEL UNDERPLATE
- MUST COMPLY WITH DIRECTIVE 2002/95/EC (ROHS)
- OPERATING TEMPERATURE: -55°C~ 105°C
- WIRE TYPES AND SIZES ACCEPTED
 SOLID WIRE: 18AWG, 20AWG, 22AWG, 24AWG
 STRAND WIRE: 18AWG (STRANDS:16); 20AWG (STRANDS:7); 22AWG (STRANDS:7)
 24AWG (UL1061/STRANDS:7)
 MAX INSULATION OD: 2.1mm MAX.
 STRIP LENGTH: 8.0±0.5mm
- PACKAGED IN TAPE AND REEL

REVISIONS				
P	LYR	DESCRIPTION	DATE	DWN APVD
A		FIRST RELEASE	13NOV2018	G.F S.M
A1		ADD NEW COLOR P/N	03SEP2019	G.F S.M

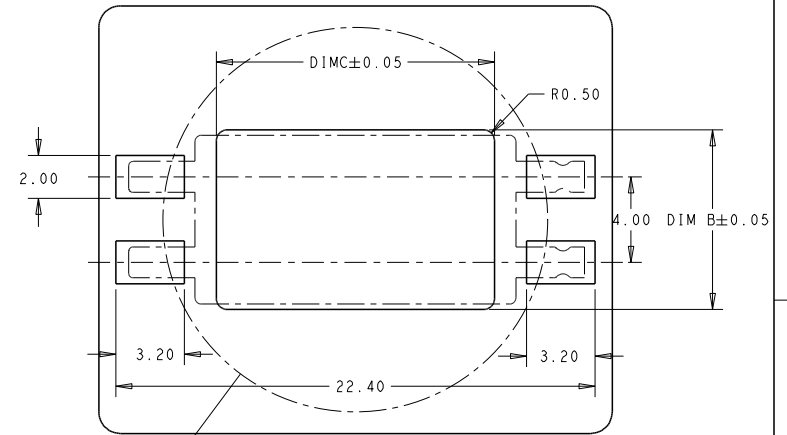
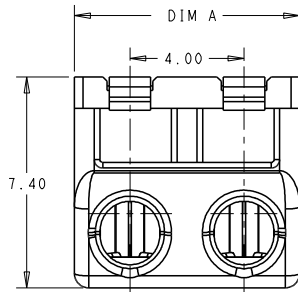
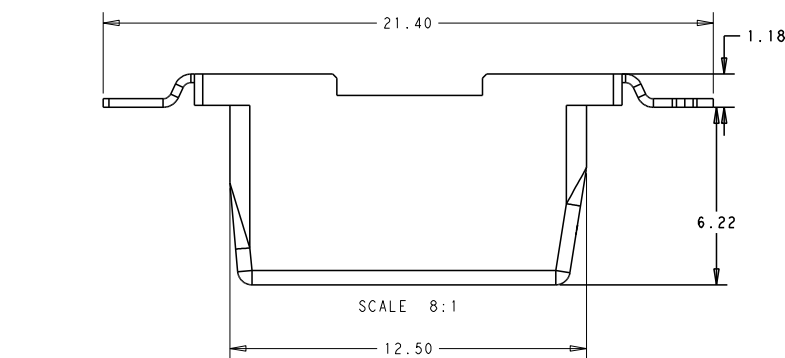
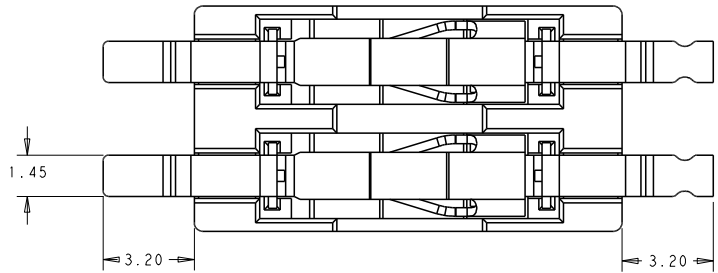

CHASSIS HOLE
 DIM Ø SEE THE TABLE
 RECOMMEND PCB LAYOUT
 (GENERAL TOLERANCE: ±0.05)

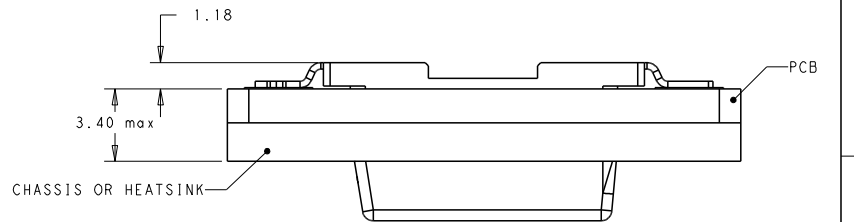

SET INSTALLTION OF PCB & CHASSIS OR HEATSINK

ADD CAP P/N: *-2834334-*

W/O CAP P/N: *-2834313-*

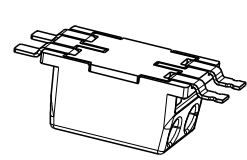

STANDARD 2P

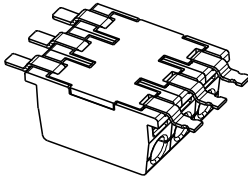

MODULAR ASSEMBLY TYPE

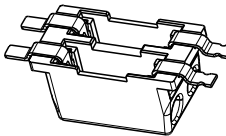

STANDARD 2P

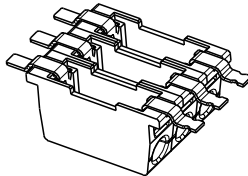

MODULAR ASSEMBLY TYPE

THIS DRAWING IS A CONTROLLED DOCUMENT.		DWN - GEORGE FU 13NOV2018		
		CHK - GEORGE FU 13NOV2018		
DIMENSIONS:		APVD - SHEI MING 13NOV2018	NAME 4.0PITCH ITB RELEASABLE POKE-IN CONNECTOR	
TOLERANCES UNLESS OTHERWISE SPECIFIED:		PRODUCT SPEC 108-137311	SIZE CAGE CODE DRAWING NO	
0 PLC ±0.20		APPLICATION SPEC 114-137311	A200779C-2834313	
1 PLC ±0.13		WEIGHT	RESTRICTED TO	
2 PLC ±0.10		CUSTOMER DRAWING	SCALE 4:1 SHEET 1 OF 2 REV A1	
3 PLC ±0.08				
4 PLC ±0.05				
ANGLES				
FINISH				

4

3

2

1

THIS DRAWING IS UNPUBLISHED. RELEASED FOR PUBLICATION 20
 © COPYRIGHT 20 BY - ALL RIGHTS RESERVED.

REVISIONS					
P	LYR	DESCRIPTION	DATE	DWN	APVD
		SEE SHEET 1			

∅21 MIN	13.1	12.6	12.0	WHITE/BLACK/RED	3	3-2834313-3
∅21 MIN	13.1	12.6	12.0	RED/BLACK/WHITE	3	2-2834313-3
∅21 MIN	13.1	12.6	12.0	BLACK/WHITE/RED	3	1-2834313-3
∅21 MIN	13.1	12.6	12.0	ALL WHITE	3	2834313-3
∅18 MIN	13.1	8.6	8.0	WHITE/BLACK	2	8-2834313-2
∅18 MIN	13.1	8.6	8.0	BLACK/RED	2	7-2834313-2
∅18 MIN	13.1	8.6	8.0	RED/BLACK	2	6-2834313-2
∅18 MIN	13.1	8.6	8.0	WHITE/RED	2	5-2834313-2
∅18 MIN	13.1	8.6	8.0	GRAY/BLUE	2	4-2834313-2
∅18 MIN	13.1	8.6	8.0	BLACK/WHITE	2	3-2834313-2
∅18 MIN	13.1	8.6	8.0	ALL BLACK	2	2-2834313-2
∅18 MIN	13.1	8.6	8.0	BROWN/YELLOW	2	1-2834313-2
∅18 MIN	13.0	8.4	8.0	WHITE	2	2834313-2 (Standard 2P)
∅16 MIN	13.1	4.6	4.0	GREEN	1	4-2834313-1
∅16 MIN	13.1	4.6	4.0	BLUE	1	3-2834313-1
∅16 MIN	13.1	4.6	4.0	BLACK	1	2-2834313-1
∅16 MIN	13.1	4.6	4.0	RED	1	1-2834313-1
∅16 MIN	13.0	4.4	4.0	WHITE	1	2834313-1
CHASSIS HOLE	DIM C	DIM B	DIM A	COLOR	POLES No	PART NO
PRODUCT WITHOUT CAP TYPE						

∅21 MIN	13.1	12.6	12.0	WHITE/BLACK/RED	3	3-2834334-3
∅21 MIN	13.1	12.6	12.0	RED/BLACK/WHITE	3	2-2834334-3
∅21 MIN	13.1	12.6	12.0	BLACK/WHITE/RED	3	1-2834334-3
∅21 MIN	13.1	12.6	12.0	ALL WHITE	3	2834334-3
∅18 MIN	13.1	8.6	8.0	BLUE/RED	2	1-2834334-0
∅18 MIN	13.1	8.6	8.0	RED/BLUE	2	9-2834334-2
∅18 MIN	13.1	8.6	8.0	WHITE/BLACK	2	8-2834334-2
∅18 MIN	13.1	8.6	8.0	BLACK/RED	2	7-2834334-2
∅18 MIN	13.1	8.6	8.0	RED/BLACK	2	6-2834334-2
∅18 MIN	13.1	8.6	8.0	WHITE/RED	2	5-2834334-2
∅18 MIN	13.1	8.6	8.0	GRAY/BLUE	2	4-2834334-2
∅18 MIN	13.1	8.6	8.0	BLACK/WHITE	2	3-2834334-2
∅18 MIN	13.1	8.6	8.0	ALL BLACK	2	2-2834334-2
∅18 MIN	13.1	8.6	8.0	BROWN/YELLOW	2	1-2834334-2
∅18 MIN	13.0	8.4	8.0	WHITE	2	2834334-2 (Standard 2P)
∅16 MIN	13.1	4.6	4.0	GREEN	1	4-2834334-1
∅16 MIN	13.1	4.6	4.0	BLUE	1	3-2834334-1
∅16 MIN	13.1	4.6	4.0	BLACK	1	2-2834334-1
∅16 MIN	13.1	4.6	4.0	RED	1	1-2834334-1
∅16 MIN	13.0	4.4	4.0	WHITE	1	2834334-1
CHASSIS HOLE	DIM C	DIM B	DIM A	COLOR	POLES No	PART NO
PRODUCT WITH CAP TYPE						

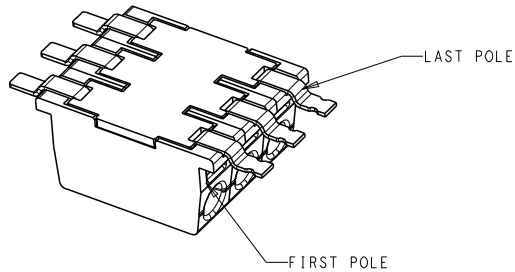

THIS DRAWING IS A CONTROLLED DOCUMENT.		DWN - GEORGE FU 13NOV2018		
		CHK - GEORGE FU 13NOV2018		
		APVD - GEORGE FU 13NOV2018	NAME 4.0PITCH ITB RELEASABLE POKE-IN CONNECTOR	
DIMENSIONS: (mm)		PRODUCT SPEC 108-137311	SIZE CAGE CODE DRAWING NO	
TOLERANCES UNLESS OTHERWISE SPECIFIED: 0 PLC ± 1 PLC ±0.20 2 PLC ±0.13 3 PLC ± 4 PLC ± ANGLES FINISH ±		APPLICATION SPEC 114-137311	A200779 ©=2834313	
MATERIAL -		WEIGHT -	RESTRICTED TO	
NOTE 1		CUSTOMER DRAWING	SCALE 4:1 SHEET 2 OF 2 REV A1	

X-ON Electronics

Largest Supplier of Electrical and Electronic Components

Click to view similar products for [Lighting Connectors](#) category:

Click to view products by [TE Connectivity](#) manufacturer:

Other Similar products are found below :

[293300-7](#) [293660-5](#) [CNX_H03_NTP](#) [30-9767-BU](#) [3605](#) [3-21030-1](#) [ZCH-110-RGB-I](#) [503471-0290](#) [ZCH-110-RGB-J](#) [217-0716-200](#)
[1954563-1](#) [1-293657-2](#) [2834036-1](#) [2834037-1](#) [1-2213222-4](#) [2-2213222-4](#) [2213222-4](#) [2834122-3](#) [2834122-5](#) [2834135-2](#) [FLA-R4142-30](#)
[FLA-R4162-30](#) [FLA-R2142-30](#) [FLA-R2141-30](#) [FLA-R2162-30](#) [FLA-R2161-30](#) [FLA-R0161-30](#) [FLA-R0141-30](#) [FLA-R0142-30](#) [FLA-](#)
[R0162-30](#) [FLA-C00-00](#) [DGA00010553](#) [CNXV04NTP](#) [104128-0610](#) [503485-0000 \(Cut Strip\)](#) [503485-0000 \(Loose Piece\)](#) [503485-0000](#)
[\(MINI Reel\)](#) [1-2834074-2](#) [1-2834074-3](#) [1357-AC PLUG W2C \(CHINA\)](#) [1357-AC PLUG W2 \(USA\)](#) [104266-0110](#) [CNXV02NTP](#) [2106212-1](#)
[2-2834074-2](#) [104266-0210](#) [293470-1](#) [293651-2](#) [293651-4](#) [1-2834006-2](#)