

© COPYRIGHT - By -

Loc	DIST	REVISIONS		DATE	DWN	APVD
ES	00	P	DESCRIPTION	24OCT11	C.Z	S.Y
		LTR				
		C3	REVISED ECR-11-021545			

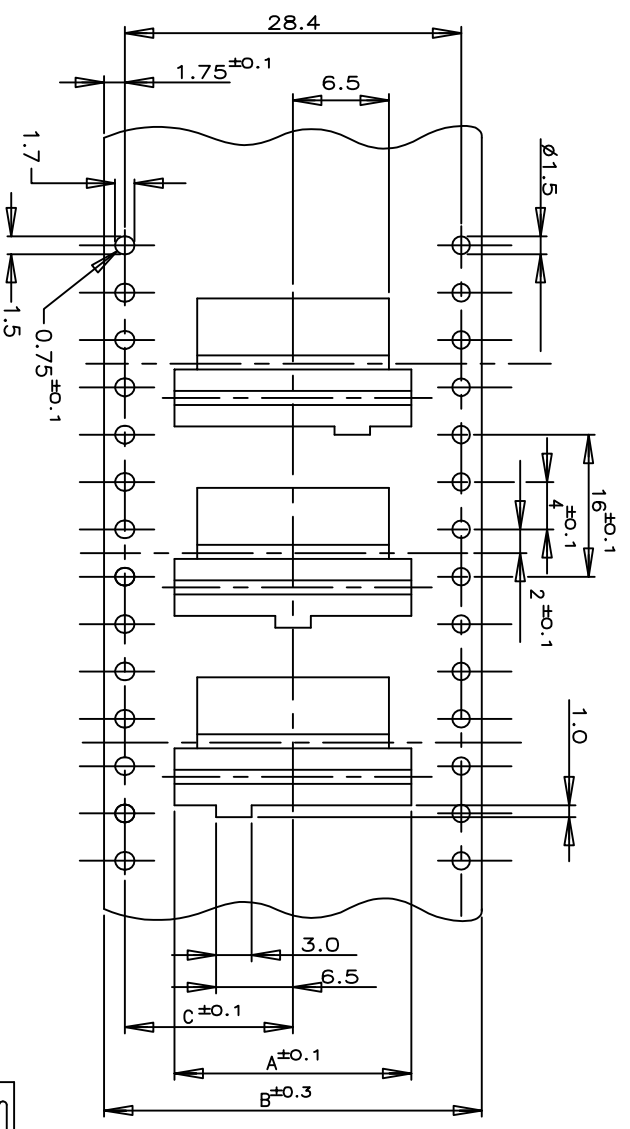
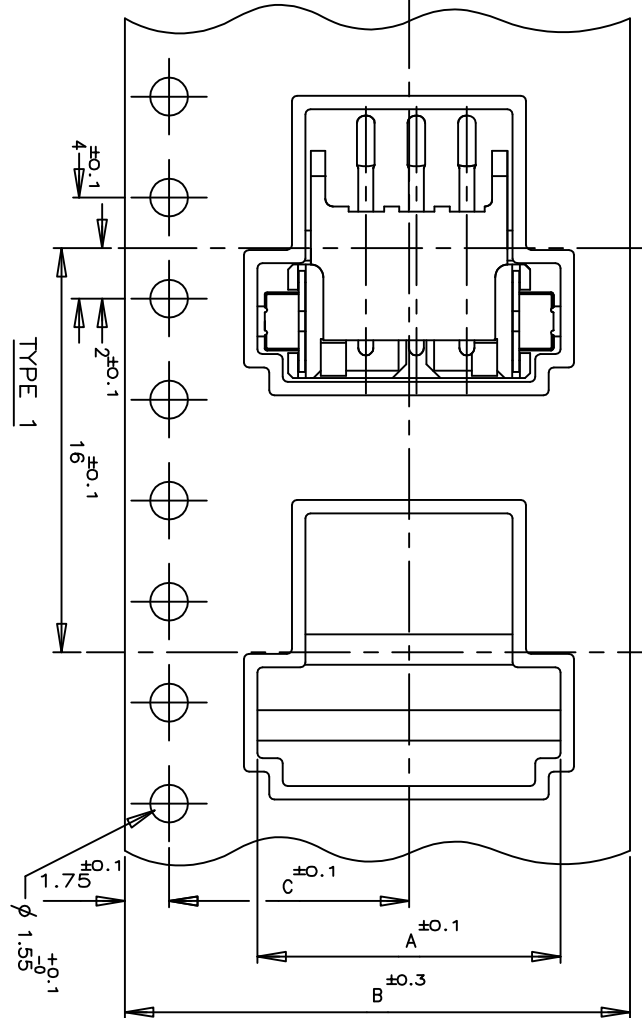

(AS SHOWN : 3P)

TYPE 3 FOR 7P ONLY
THREE KINDS OF DIFFERENT POCKETS AS 1 SET
USED FOR 7P ONLY

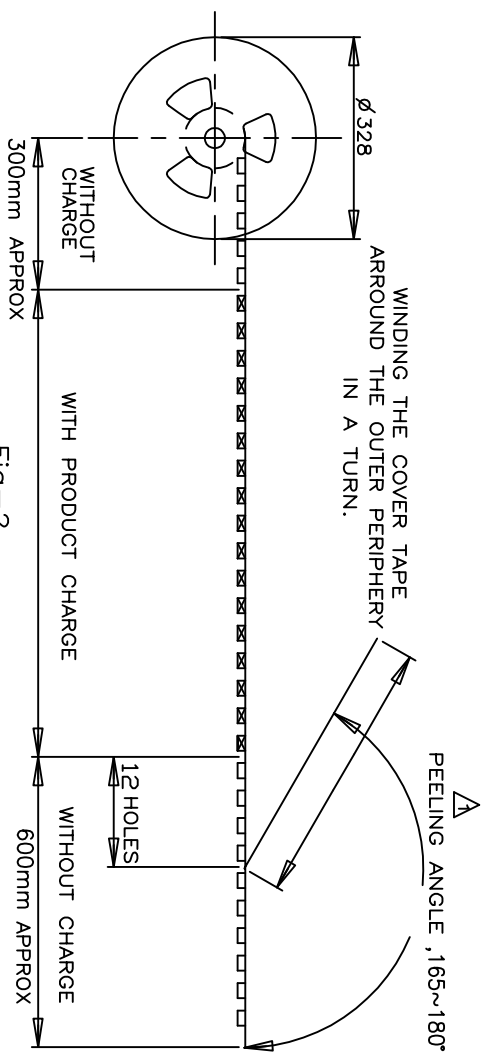
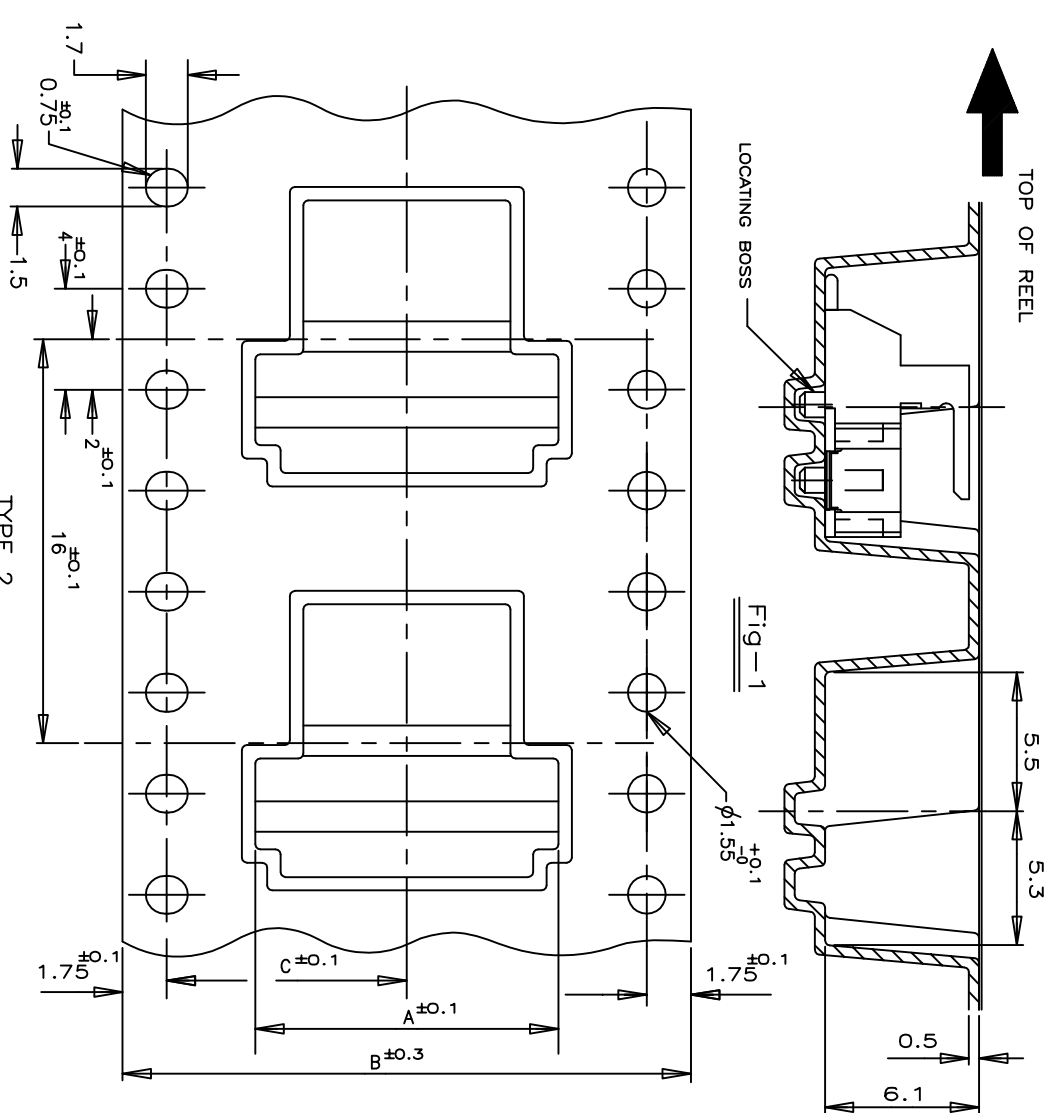
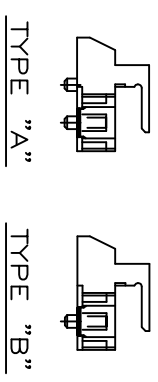

COLOR	BLACK		NATURAL		WITH	TAPING P/N		
	WITH	PLATE	WITH	PLATE				
	TYPE 2	B	20.2	44	24	500	9	1-292173-9
	TYPE 3	B	20.2	44	22	500	8	1-292173-8
	TYPE 2	B	14.2	32	20	500	7	1-292173-7
	TYPE 2	B	14.2	32	18	500	6	1-292173-6
	TYPE 3	B	11.5	24	16	500	5	1-292173-5
	TYPE 1	B	11.5	24	16	500	5	1-292173-5
	TYPE 1	A	11.5	24	14	500	4	1-292173-4
	TYPE 1	A	11.5	24	12	500	3	1-292173-3
	TYPE 2	B	20.2	44	24	500	2	1-292173-2
	TYPE 2	B	20.2	44	22	500	1	1-292173-1
	TYPE 3	B	14.2	32	20	500	7	1-292173-7
	TYPE 2	B	14.2	32	18	500	6	1-292173-6
	TYPE 2	B	11.5	24	16	500	5	1-292173-5
	TYPE 1	B	11.5	24	14	500	4	1-292173-4
	TYPE 1	A	11.5	24	12	500	3	1-292173-3

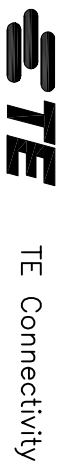

TE Connectivity

ON TAPING (EMBOSS)

TE CT CONNECTOR POST HEADER ASS'Y
(BOX-H SMT TYPE W/BOSS & TAIL)

THIS DRAWING IS A CONTROLLED DOCUMENT.		DWN	21SEP10
DIMENSIONS: MM		CHK	JACK HOU
TOLERANCES UNLESS OTHERWISE SPECIFIED:		APVD	MARTIN LI
0 PLC	±	21SEP10	STEVEN YAO
1 PLC	±	PRODUCT SPEC	
2 PLC	±	APPLICATION SPEC	
3 PLC	±	WEIGHT	
4 PLC	±	CUSTOMER DRAWING	
ANGLES	±		

SIZE	A3	CAGE CODE	00779	DRAWING NO	292173	RESTRICTED TO
SCALE	1/1	SHEET	1	OF	6	REV
						C3

TOLERANCE UNLESS OTHERWISE SPECIFIED:	±0.2
10>±	±0.25
30>±	±0.3
100>±	±0.3
ANGLE	±3°

NOTES:
▲ PEELING RESISTANCE : 0.196N-0.686N (20gf-70gf)
SPEED : 300mm/min

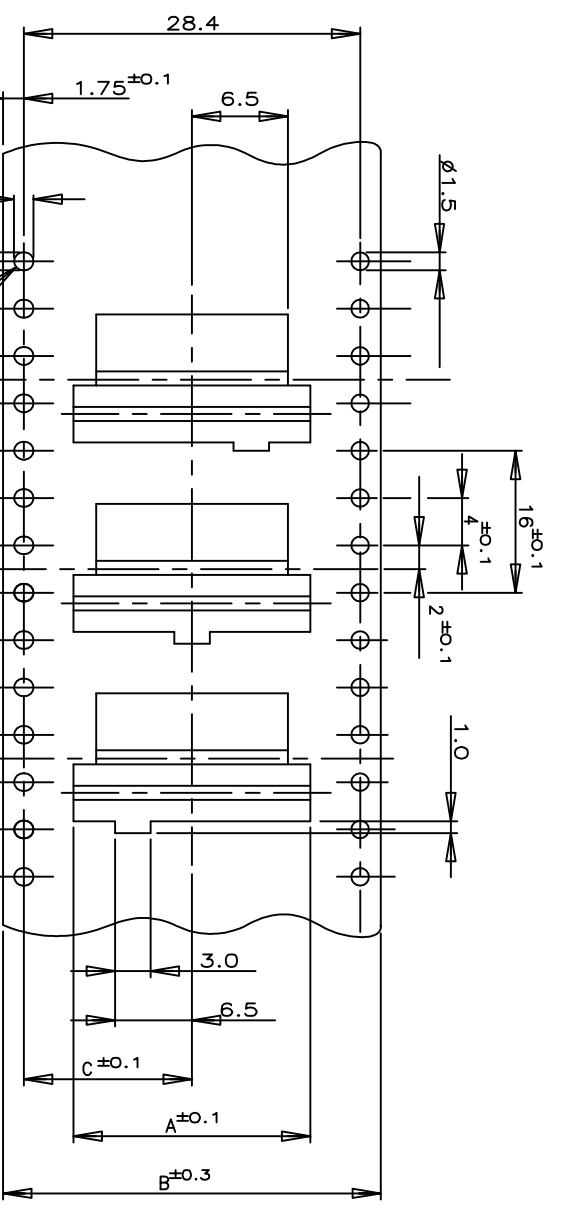
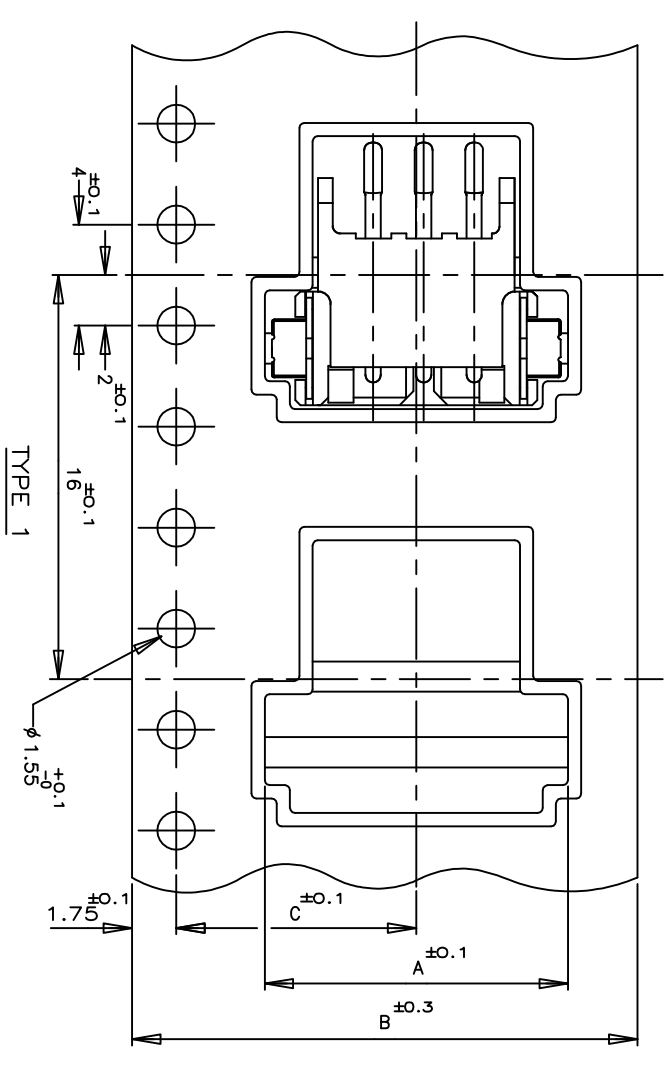

TYPE 3 FOR 7P ONLY
THREE KINDS OF DIFFERENT POCKETS AS 1 SET
USED FOR 7P ONLY

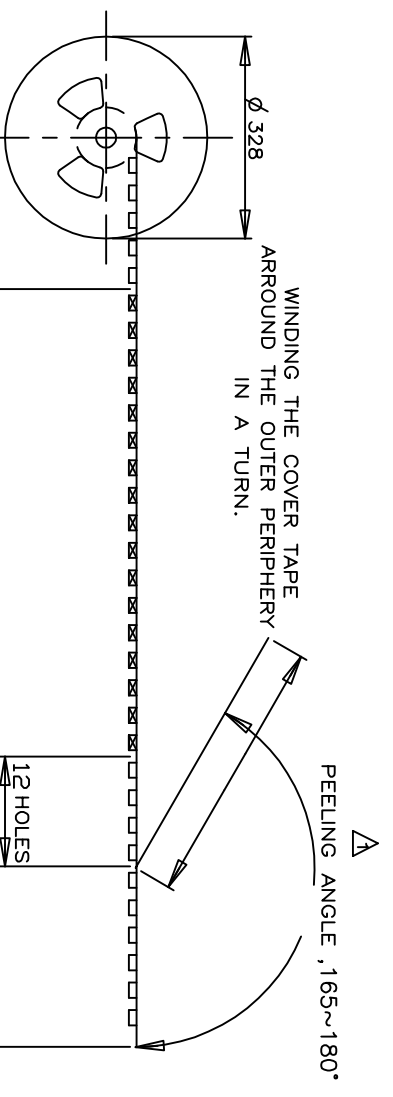
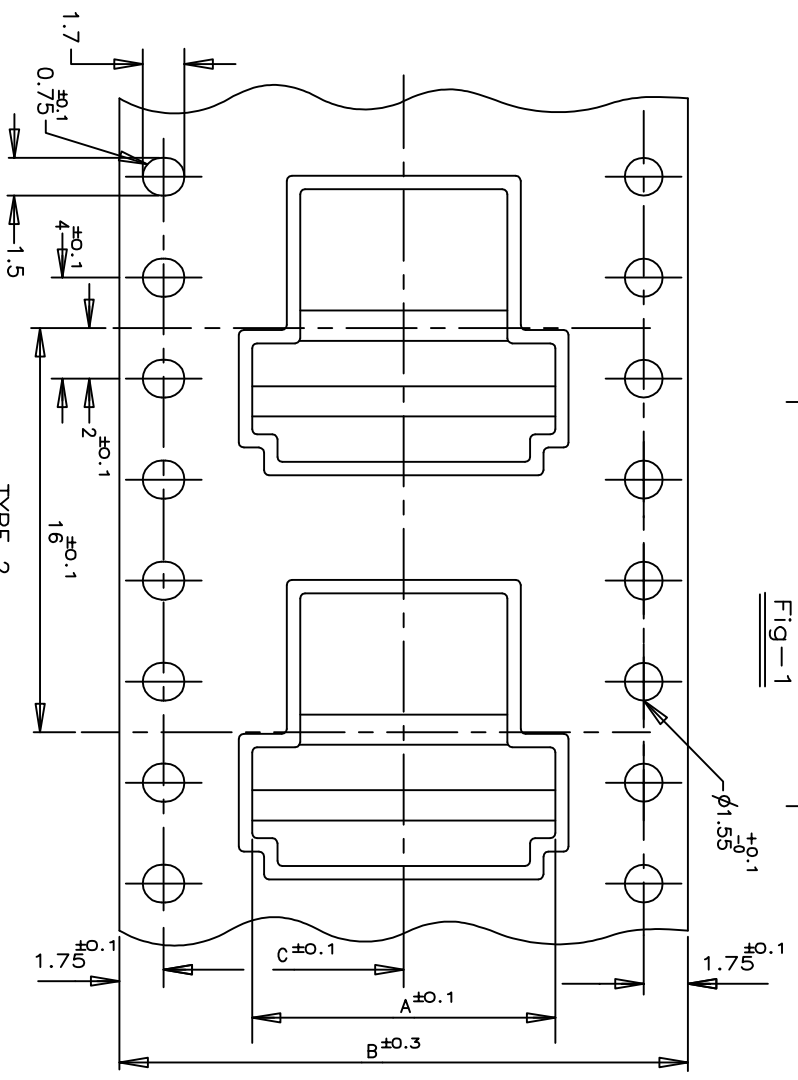
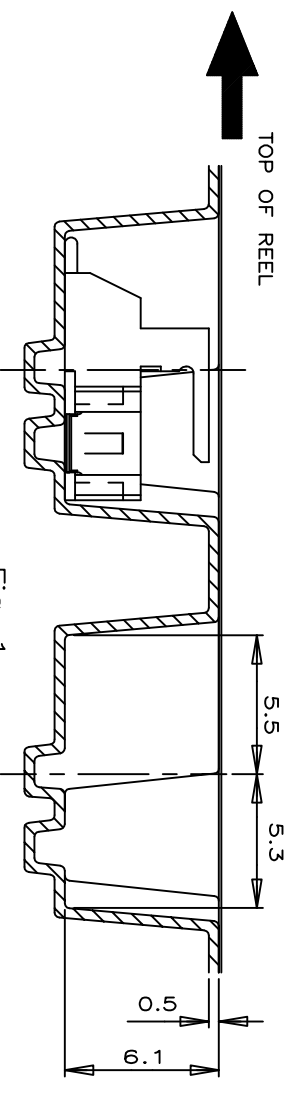
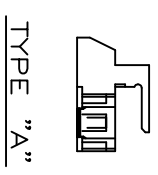

COLOR	WITH	TYPE	BLACK		NATURAL		TYPE OF BOSS	C	B	A	QTY/ REEL	Pos	TAPING P/N
			PLATE	WITH	PLATE	WITH							
BLACK	TYPE 2	A	20.2	44	24	500	9	3-292173-9					
	TYPE 3	A	20.2	44	22	500	8	3-292173-8					
	TYPE 2	A	14.2	32	18	500	6	3-292173-6					
NATURAL	TYPE 2	A	11.5	24	16	500	5	3-292173-5					
	TYPE 3	A	11.5	24	16	500	5	3-292173-5					
	TYPE 1	A	11.5	24	10	500	2	3-292173-2					
BLACK	TYPE 2	A	20.2	44	24	500	9	2-292173-9					
	TYPE 2	A	20.2	44	22	500	8	2-292173-8					
	TYPE 3	A	14.2	32	20	500	7	2-292173-7					
NATURAL	TYPE 2	A	14.2	32	18	500	6	2-292173-6					
	TYPE 2	A	11.5	24	16	500	5	2-292173-5					
	TYPE 1	A	11.5	24	14	500	4	2-292173-4					
BLACK	TYPE 1	A	11.5	24	12	500	3	2-292173-3					
	TYPE 1	A	11.5	24	12	500	3	2-292173-3					
	TYPE 1	A	11.5	24	10	500	2	2-292173-2					

STE TE Connectivity

ON TAPING (EMBOSS)

TE CT CONNECTOR POST HEADER ASS'Y
(BOX-H SMT TYPE W/O BOSS & W/ TAIL)

SIZE A3
CAGE CODE 00779
DRAWING NO. 292173

CUSTOMER DRAWING

SCALE 1:1 SHEET 2 OF 6 REV C3

THIS DRAWING IS A CONTROLLED DOCUMENT.

DIMENSIONS:	TOLERANCES UNLESS OTHERWISE SPECIFIED:
MM	0 PLC ±
	1 PLC ±
	2 PLC ±
	3 PLC ±
	4 PLC ±
	ANGLES ±



NOTES:
△ PEELING RESISTANCE : 0.196N-0.686N (20gf-70gf)
SPEED : 300mm/min

TOLERANCE UNLESS OTHERWISE SPECIFIED:

10>*	±0.2
30>~>10	±0.25
100>~>30	±0.3
ANGLE	±3°

Loc	DIST	REVISIONS	DATE	DWN	APVD
ES	00				
P	LTR	DESCRIPTION			
-	-	SEE SHEET 1			

LAYOUT FOR 292173-X,1-292173-X

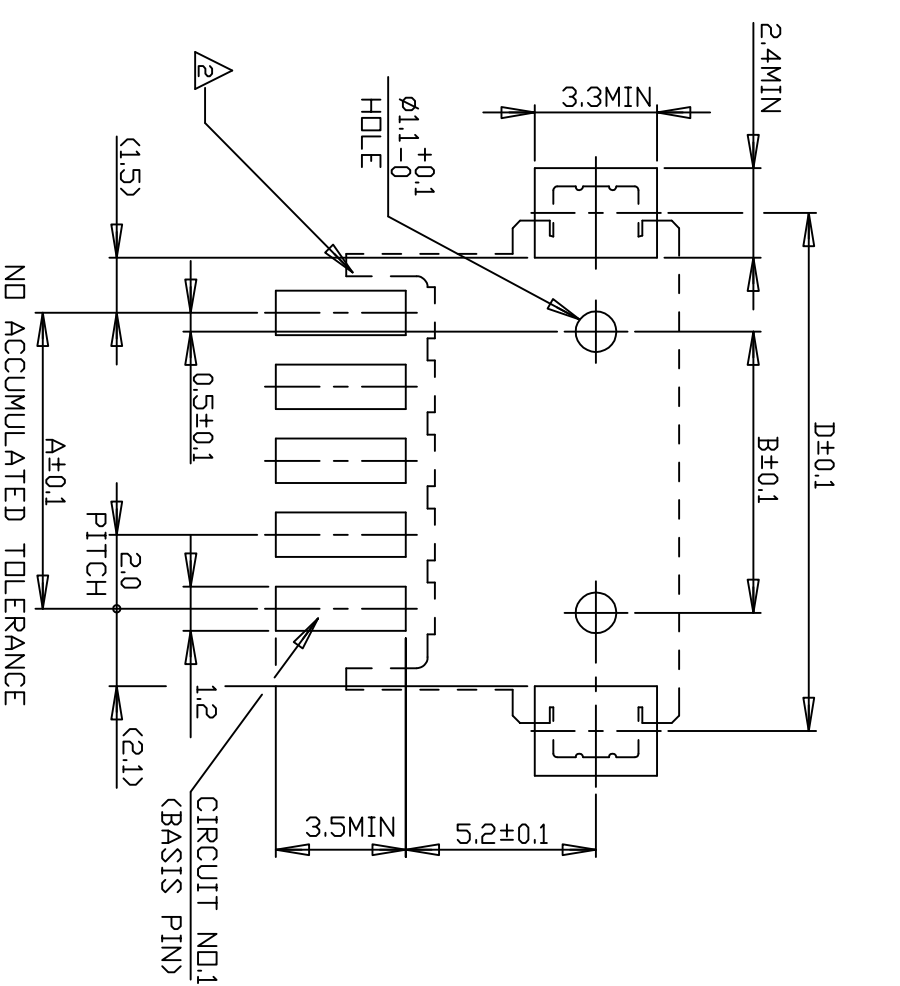

5 POS. & ABOVE POS.

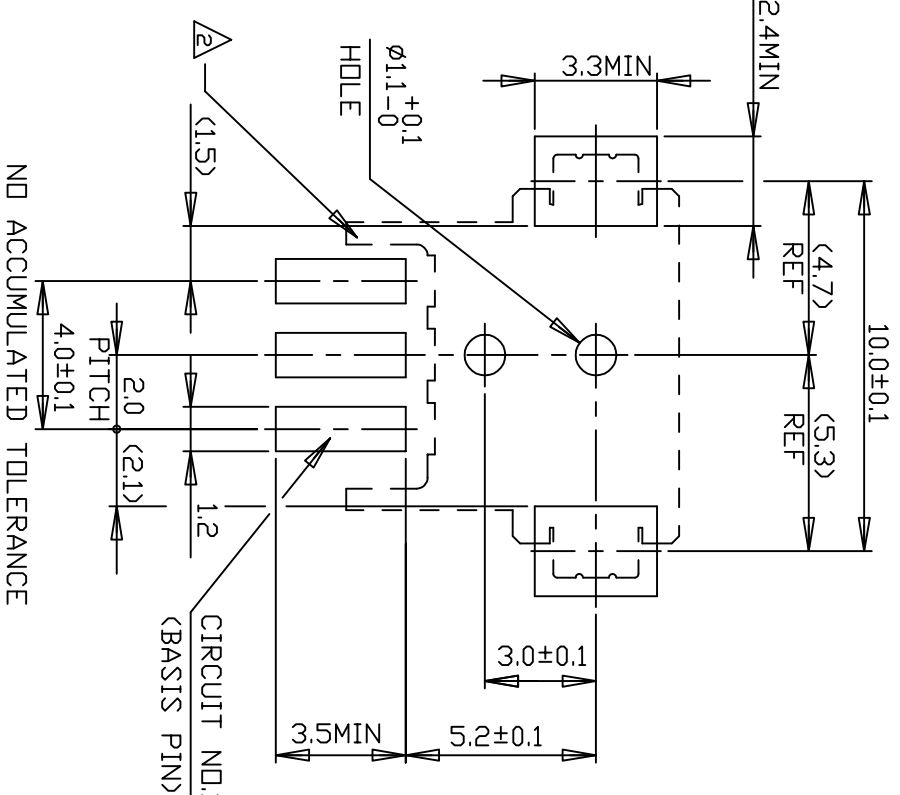

3 POS.

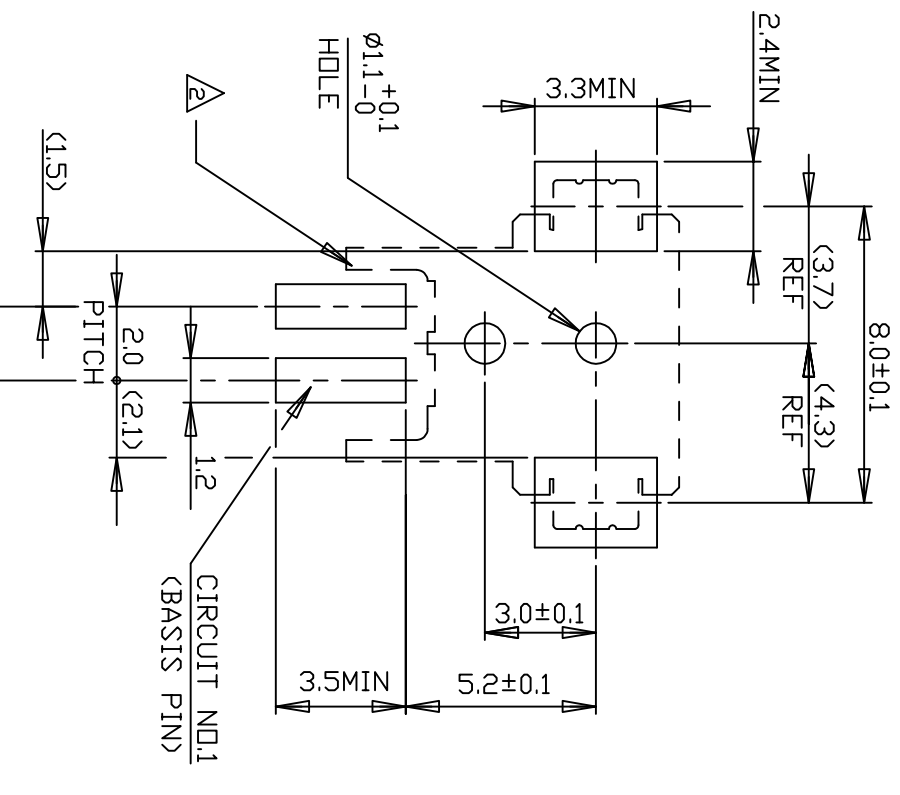

2 POS.

RECOMMENDED P.C. BOARD LAYOUT
(P.C.B THK:0.8mm MIN)

THIS DRAWING IS A CONTROLLED DOCUMENT.

DIMENSIONS:	MM	TOLERANCES UNLESS OTHERWISE SPECIFIED:	DMN	CHK	NAME
		0 PLC	-	-	<p>STE TE Connectivity</p> <p>SMT TYPE POST HDR ASS'Y (H) WITH BOSS & TAIL TYPE (TE CT CONN. 2mm PITCH)</p>
		1 PLC	-	-	
		2 PLC	-	-	
		3 PLC	-	-	
		4. P.C. ANGLES	-	-	APVD
MATERIAL		FINISH			PRODUCT SPEC
					APPLICATION SPEC
					WEIGHT
					CUSTOMER DRAWING
					SIZE
					A3
					CAGE CODE
					00779
					DRAWING NO
					292173
					RESTRICTED TO
					SCALE
					5:1
					SHEET
					4 OF 6
					REV
					C3

Loc	DIST	REVISIONS	
ES	00	P	DESCRIPTION
		LTR	DATE
		-	DWN
		SEE SHEET 1	APVD

LAYOUT FOR 2-292173-X,3-2-292173-X

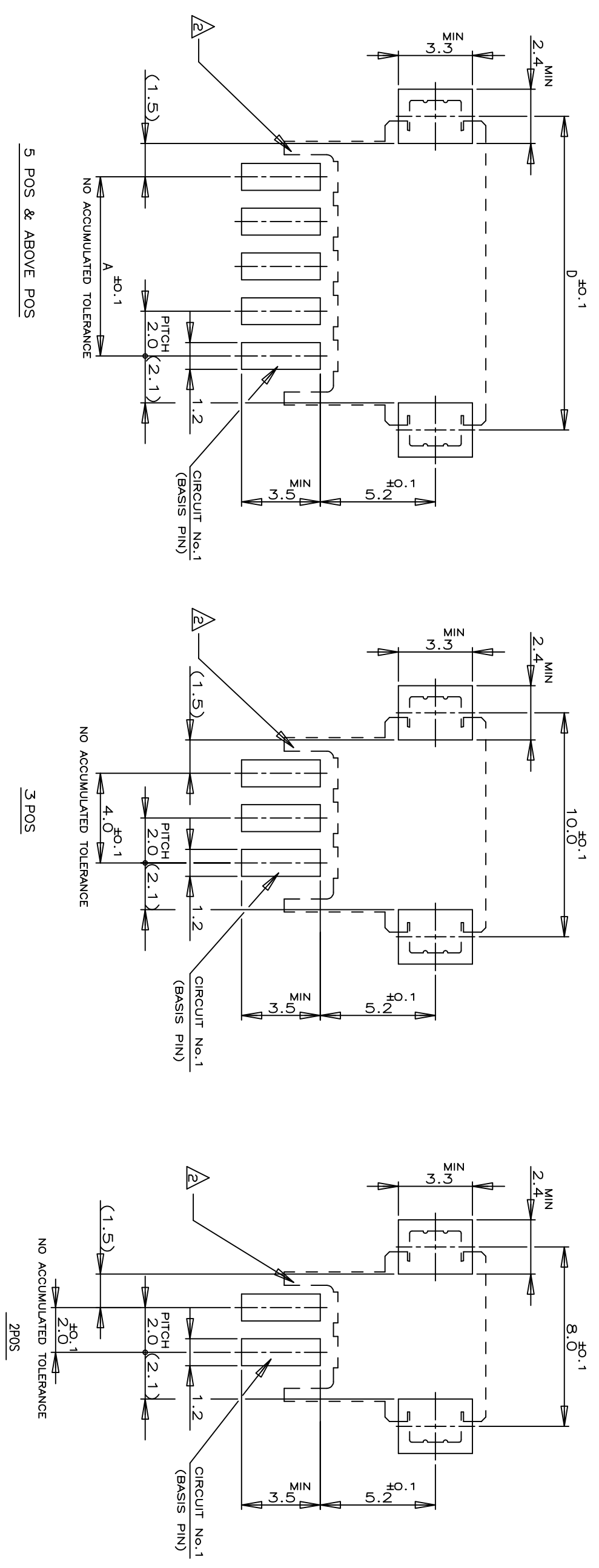

RECOMMENDED P.C.BOARD LAYOUT
(P.C.B THK:0.8mm MIN)

THIS DRAWING IS A CONTROLLED DOCUMENT.

DIMENSIONS: MM	TOLERANCES UNLESS OTHERWISE SPECIFIED:	DWN	NAME
	0 PLC ±	CHK	 TE Connectivity SMT TYPE POST HDR ASS'Y (H) W/O, WITH TAIL TYPE (TE CT CONN. 2mm PITCH)
	1 PLC ±	APVD	
	2 PLC ±	PRODUCT SPEC	
	3 PLC ±	APPLICATION SPEC	
	4 P.C.B. ANGLES ±	WEIGHT	SIZE
	FINISH		A3
			CAGE CODE
			00779
			DRAWING NO
			292173
			SCALE
			5:1
			SHEET
			6 OF 6
			REV
			C3

CUSTOMER DRAWING

X-ON Electronics

Largest Supplier of Electrical and Electronic Components

Click to view similar products for [Headers & Wire Housings](#) category:

Click to view products by [TE Connectivity](#) manufacturer:

Other Similar products are found below :

[95000-104TRLF](#) [10135584-644402LF](#) [DF62W-EP2022PCA](#) [95000-106TRLF](#) [DF62W-2022SCA](#) [DF62W-EP2022PC](#) [2203348](#) [DF62W-2022SC](#) [1084018](#) [1029039](#) [1084017](#) [802-10-012-10-002000](#) [1112640](#) [1112639](#) [000-34000](#) [0009482033](#) [0009507031](#) [57102-S06-03LF](#) [57202-S52-04LF](#) [PCN6-15S-2.5E](#) [0039019024](#) [58102-G61-06LF](#) [582553-1](#) [0009508121](#) [0050291907](#) [018731A](#) [LY20-4P-DT1-P1E-BR](#) [02.125.8002.8](#) [60101931](#) [60598-1 \(Cut Strip\)](#) [M1625-3R/100](#) [61062-3](#) [61082-181009](#) [636-1427](#) [638009-1](#) [641938-9](#) [641991-4](#) [644168-1](#) [647662-1](#) [65039-019ELF](#) [65817-002LF](#) [65817-015LF](#) [65863-015LF](#) [66207-023LF](#) [67016-026LF](#) [67046-001LF](#) [67095-007LF](#) [68002-116](#) [68016-236H](#) [68648-049](#)