

## Type 3521 Series

### Key Features

2 Watts at  
70°C

Small size to  
power ratio

Supplied on  
tape

Value marked  
on resistor

500 volt  
maximum  
overload

250 volt  
maximum  
working  
voltage

Terminal finish  
matte Sn over  
Ni

AEC-Q200  
Qualified



TE Connectivity is pleased to announce that our 3521 series high power Thick Film Chip Resistor is now AEC-Q200 Qualified. This low cost device, suitable for auto placement in volume, and for most applications, including high frequency operations, owing to the short lead structure, is attractively priced and available on 7" reels of 4000 pieces.

### Characteristics – Electrical

Power Rating	2W
Resistance Range	0.1Ω ~ 10MΩ
Tolerance	±1% ±5%
Max. Working Voltage	250V
Max. Overload Voltage	500V
Dielectric Withstanding Voltage	500V
Temperature Range	-55°C ~ +155°C
Ambient Temperature	70°C

Resistors shall have a power rating based on continuous load operation at an ambient temperature of 70 °C . For temperature in excess of 70 °C , The load shall be derated as shown below:



### Voltage Rating:

Resistors shall have a rated direct-current (DC) continuous working voltage or an approximate sine-wave root-mean-square (RMS) alternating-current (AC) continuous working voltage at commercial line frequency and waveform corresponding to the power rating, as determined from the following formula:

$$RCWV = \sqrt{P \times R}$$

Where:

RCWV = Rated DC or RMS AC continuous working voltage at commercial-line frequency and waveform (volt)

P = Power Rating (watt)

R = Nominal Resistance (ohm)

In no case shall the rated DC or RMS AC continuous working voltage be greater than the applicable maximum value.

### Construction & Dimensions:

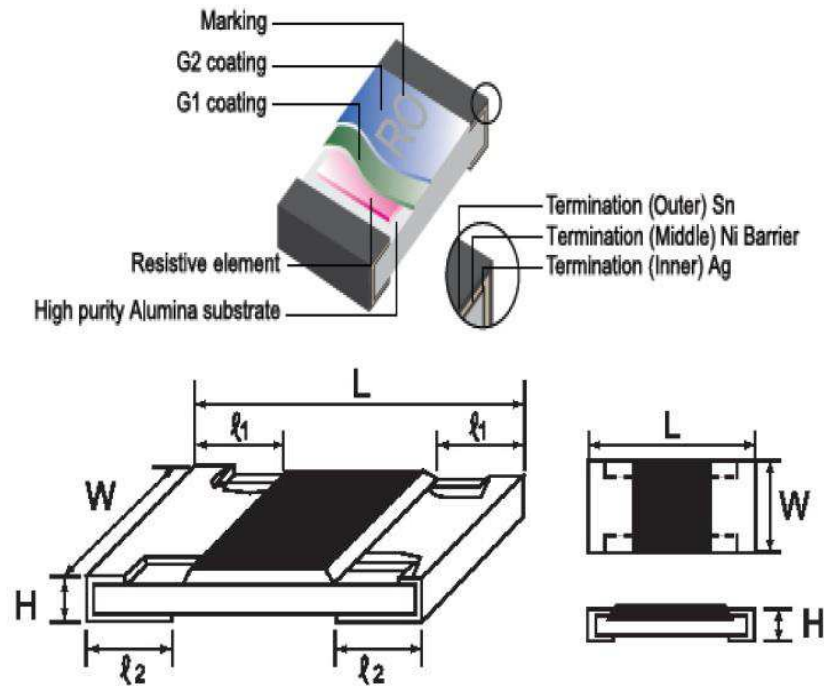

Dimensions: (mm)

L	W	H	l1	l2
6.35±0.10	3.20±0.20	0.55±0.10	0.60±0.25	0.50±0.20

### Recommended solder pad

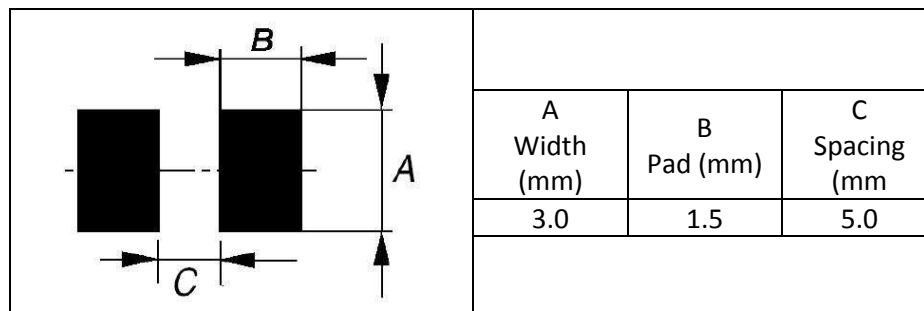

4 layers PCB specification:

- 1) Outside 2 layers (Top and Bottom) with copper foil thickness at 2oz.
- 2) Inside 2 layers (Middle layers) with copper foil thickness at 4 oz.

### Marking:

For E24 series Values three digit marking, the first two digits are significant figures and the third denoting number of zeros.

E.G.

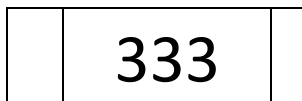

33K $\Omega$

For Ohmic Values below 10 $\Omega$

E.G.

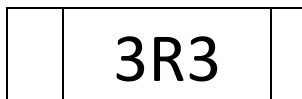

3.3 $\Omega$

For E96 Values four digit marking, the first three showing significant figures and the fourth showing number of zeros. As previously letter R is for decimal point.

E.G.

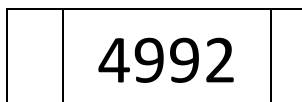

49K9 $\Omega$

## Performance Specification:

Characteristics	Limits	Test Methods
Operational life	$\pm(1\%+0.1\Omega)\text{max}$	125°C, at 35% of operating power, 1000H (1.5 hours "ON", 0.5 hour "OFF"). <b>(MIL-STD-202)</b>
	<100mΩ	Apply to rate current for 0Ω
Electrical Characterisation	0.1Ω<R≤0.976Ω ±100PPM 1Ω ≤ R ≤10Ω ≤ ±400PPM/°C 10Ω < R ≤100Ω ≤ ±200PPM/°C 100Ω<R≤10MΩ ≤ ±100PPM/°C	Parametrically test per lot and sample size requirements, summary to show Min, Max, Mean and Standard deviation at room as well as Min and Max operating temperatures. (User Spec)
External Visual	No Mechanical Damage	Electrical test not required. Inspect device construction, marking and workmanship <b>(MIL-STD-883 Method 2009)</b>
Physical Dimension	Reference 2.0 Dimension Standards	Verify physical dimensions to the applicable device detail specification. Note: User(s) and Suppliers spec. Electrical test not required. <b>(JESD22 MH Method JB-100)</b>
Resistance to Solvent	Marking Unsmearred	Note: Add Aqueous wash chemical – OKEM Clean or equivalent. Do not use banned solvents. <b>( MIL-STD-202 Method 215)</b>
Terminal Strength	Not broken	Force of 1.8kg for 60 seconds. <b>(JIS-C-6429)</b>
High Temperature Exposure (Storage)	Resistance change rate is $\pm (0.5\%+0.1\Omega)$ Max.	1000hrs. @T=155°C.Unpowered. Measurement at 24±2 hours after test conclusion. <b>(MIL-STD-202 Method 108)</b>
	<50mΩ	Apply to rate current for 0Ω
Temperature cycling	Resistance change rate is $\pm (0.5\%+0.1\Omega)$ Max.	1000 Cycles (-55°C to +155°C). Measurement at 24±2 hours after test conclusion <b>(JESD22 Method JA-104)</b>
	<50mΩ	Apply to rate current for 0Ω
Moisture Resistance	Resistance change rate is $\pm (0.5\%+0.1\Omega)$ Max.	 <p>The graph shows a temperature cycle between 0°C and 85°C. The cycle consists of 12 hours at 85°C, 12 hours at 0°C, and 12 hours at 85°C. The temperature is held at each level for 12 hours. The test is unpowered.</p>
	<50mΩ	Apply to rate current for 0Ω
Biased Humidity	Resistance change rate is $\pm (1\%+0.1\Omega)$ Max	10% rated power, 85°C/85%RH, 1000H. Measurement at 24 hours after test conclusion. <b>(MIL-STD-202 Method 103)</b>
	<100mΩ	Apply to rate current for 0Ω
Mechanical Shock	$\pm(1\%+0.1\Omega)$ max	Wave Form: Tolerance for half sine shock pulse. Peak value is 100g's. Normal duration (D) is 6. <b>(MIL-STD-202 Method 213)</b>
Vibration	$\pm(1\%+0.1\Omega)$ max	5g's for 20 min., 12cycle each of 3 orientations. Note: Use 8"*5"PCB. 031" thick 7 secure points (onone) long side and 2 secure points at corners of opposite sides. Parts mounted within 2' from any secure point. Test from 10-2000Hz. <b>(MIL-STD-202 Method 204)</b>

## Performance Specification (continued)

Characteristics	Limits	Test Methods
Thermal Shock	$\pm(1\%+0.1\Omega)$ max	-55°C/+155°C Note: Number of cycles required -300, Maximum transfer time -20 seconds, Dwell time -15 minutes. Air-Air. <b>(MIL-STD-202 Method 107)</b>
	<50mΩ	Apply to rate current for 0Ω
ESD	$\pm(10\%+0.1W)$ max	With the electrometer in direct contact with the discharge tip, verify the voltage setting at levels of $\pm 500V, \pm 1KV, \pm 2KV, \pm 4KV, \pm 8KV,$ The electrometer reading shall be within $\pm 10\%$ for voltages from 500V to $\leq 800V.$ <b>(AEC-Q200-002)</b>
Solderability	95% coverage Min.	For both leaded & SMD. Electrical test not required Magnification 50X. Conditions: a) Method B 4hrs at 155°C dry heat, the dip in bath with 245°C, 5s. b) Method B: at 215°C, 5s. c) Method D: at 260°C, 60s. <b>(J-STD-002)</b>
Flammability	No ignition of the tissue paper or scorching of the pinewood board	V-0 or V-1 are acceptable. Electrical test not required. <b>(UL-94)</b>
Board Flex	$\pm(1\%+0.05W)$ max	2mm (Min) <b>(JIS-C-6429)</b>
	<50mW	Apply to rate current for 0 W
Flame Retardance	No flame	Temperature sensing at 500Ω, Voltage power subjected to 32VDC current clamped up to 500ADC and decreased in 1.0VDC/hour. <b>(AEC-Q200-001)</b>
Resistance to soldering Heat	$\pm(1\%+0.05\Omega)$ max.	Condition B No per-heat of samples. Note: Single Wave Solder-Procedure 2 for SMD and Procedure 1 for Leaded with solder within 1.5mm of device body. <b>(MIL-STD-202 Method 210)</b>
	<50mW	Apply to rate current for 0 W

\* Sulfuration test: H2S 3~5PPM 50°C ± 2°C 91%~93%RH 1000H

## Packaging specification

### Embossed Taping:

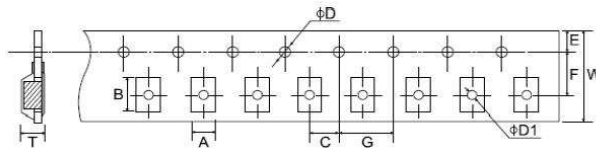

A	B	C	$\varnothing D+0.1$	$\varnothing D1+0.1$	E	F	G	W	T ±
±0.2	±0.2	±0.05	-0	-0	±0.1	±0.05	±0.1	±0.2	0.1
3.50	6.70	2.0	1.5	1.5	1.75	5.5	4.0	12.0	1.0

### Peeling Strength of Top Cover Tape

Test Condition: 0.1 to 0.7 N at a peel-off speed of 300 mm / min.



### Reel Dimensions

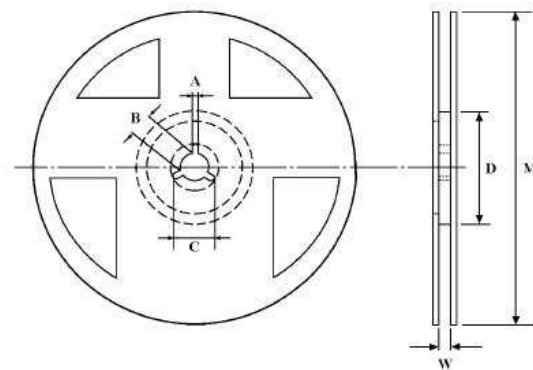

Tape	Reel Qty	A ±	B ±	C ±	D ± 1	M ± 2	W ± 1
Embossed	4,000	0.5	0.5	0.5	60	178	13.8

### Environment Related Substance

This product complies to EU RoHS directive, EU PAHs directive, EU PFOS directive and Halogen free.

### Ozone layer depleting substances.

Ozone depleting substances are not used in our manufacturing process of this product.

This product is not manufactured using Chloro fluorocarbons (CFCs), Hydrochlorofluorocarbons (HCFCs), Hydrobromofluorocarbons (HBFCs) or other ozone depleting substances in any phase of the manufacturing process.

## Storage Condition

The performance of these products, including the solderability, is guaranteed for a year from the date of arrival at your company, provided that they remain packed as they were when delivered and stored at a temperature of  $25^{\circ}\text{C} \pm 10^{\circ}\text{C}$  and a relative humidity of  $60\%RH \pm 10\%RH$ , chemical and dust free atmosphere

Even within the above guarantee periods, do not store these products in the following conditions, otherwise their electrical performance and/or solderability may be deteriorated, and the packaging materials (e.g. taping materials) may be deformed or deteriorated, resulting in mounting failures.

1. In salty air or in air with a high concentration of corrosive gas, such as  $\text{Cl}_2$ ,  $\text{H}_2\text{S}$ ,  $\text{NH}_3$ ,  $\text{SO}_2$ , or  $\text{NO}_2$
2. In direct sunlight

## AEC-Q200

The 3521 series is qualified to AEC-Q200 standard at Grade"4"

## How To Order

3521	10K	F	T
Common Part	Resistance Value	Tolerance	Pack Style
3521 – SMD Power Resistor	1 $\Omega$ - 1R0 100 $\Omega$ - 100R 1,000 $\Omega$ (1K $\Omega$ ) - 1K0 10,000 $\Omega$ (10K $\Omega$ ) - 10K 1,000,000 $\Omega$ (1M $\Omega$ ) - 1M0	F – 1%	T – 4000 Reel

## X-ON Electronics

Largest Supplier of Electrical and Electronic Components

*Click to view similar products for* [Thick Film Resistors - SMD category:](#)

*Click to view products by* [TE Connectivity manufacturer:](#)

Other Similar products are found below :

[CR-05FL7--19K6](#) [CR-05FL7--243R](#) [CR-05FL7--40K2](#) [CR-12FP4--324R](#) [CR-12JP4--680R](#) [CRCW06036K80FKEE](#) [M55342K06B309DRS3](#)  
[M55342K06B6E81RS3](#) [M55342K08B100DRWB](#) [M55342M05B200DRWB](#) [M55342M06B26E7RS3](#) [MC0603-511-JTW](#) [742C083750JTR](#)  
[MCR01MZPF1601](#) [MCR01MZPF1800](#) [MCR01MZPJ822](#) [MCR03EZHZ103](#) [MCR03EZPFX1272](#) [MCR10EZPF2003](#) [RC0603F1473CS](#)  
[RC0603F150CS](#) [RC1005F1152CS](#) [RC1005F1182CS](#) [RC1005F1372CS](#) [RC1005F183CS](#) [RC1005F1911CS](#) [RC1005F1912CS](#)  
[RC1005F203CS](#) [RC1005F2052CS](#) [RC1005F241CS](#) [RC1005F2431CS](#) [RC1005F3011CS](#) [RC1005F303CS](#) [RC1005F4321CS](#)  
[RC1005F4642CS](#) [RC1005F471CS](#) [RC1005F4751CS](#) [RC1005F5621CS](#) [RC1005F6041CS](#) [RC1005J106CS](#) [RC1005J121CS](#) [RC1005J122CS](#)  
[RC1005J154CS](#) [RC1005J180CS](#) [RC1005J181CS](#) [RC1005J183CS](#) [RC1005J202CS](#) [RC1005J204CS](#) [RC1005J272CS](#) [RC1005J391CS](#)