

Type 3540 Series

Key Features

4W@70°C in
2817 size
package

Suitable for
auto
placement

Available from
distribution

Terminal finish
matte sn over
ni barrier



TE Connectivity is pleased to introduce this thick film high power device, sister to our popular 3522 series, suitable for auto placement in volume and for most applications. Supplied as standard on 7 inch Reels of 2000 pieces per reel.

Characteristics – Electrical

Power Rating @ 70°C	4W
Resistance Range	1Ω ~ 10MΩ
Resistance Tolerance	±1%, ±5%
Temperature Coefficient of Resistance (TCR)	1Ω~10Ω ≤± 200PPM/°C
	10.1Ω~10MΩ ≤± 100PPM/°C
Max. Working Voltage	250V
Max. Overload Voltage	500V
Dielectric Withstanding Voltage	500V
Operating Temperature Range	-55°C ~ 155°C

Resistors shall have a rated direct-current (DC) continuous working voltage or an approximate sine-wave root-mean-square (RMS) alternating-current (AC) continuous working voltage at commercial line frequency and waveform corresponding to the power rating, as determined from the following formula :

$$RCWV = \sqrt{P \times R}$$

Where the calculated RCWV is greater than the stated Max. Working Voltage, the Max. Working Voltage will apply.

Power Rating and Derating

Resistors shall have a power rating based on continuous load operation at an ambient temperature of 70 °C . For temperature in excess of 70 °C , The load shall derate as shown in chart below.

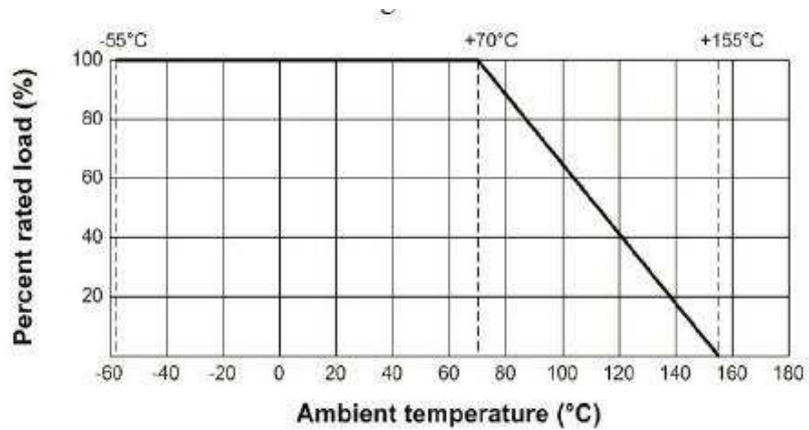

Construction and Dimensions:

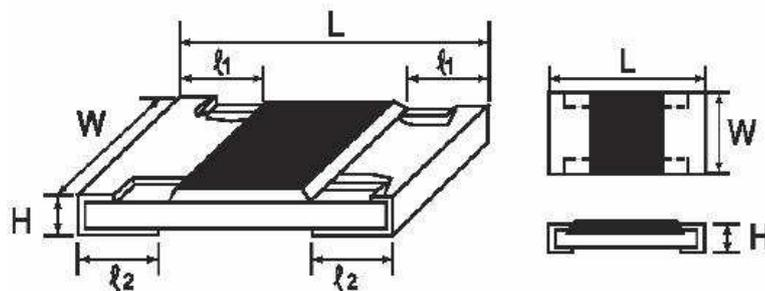
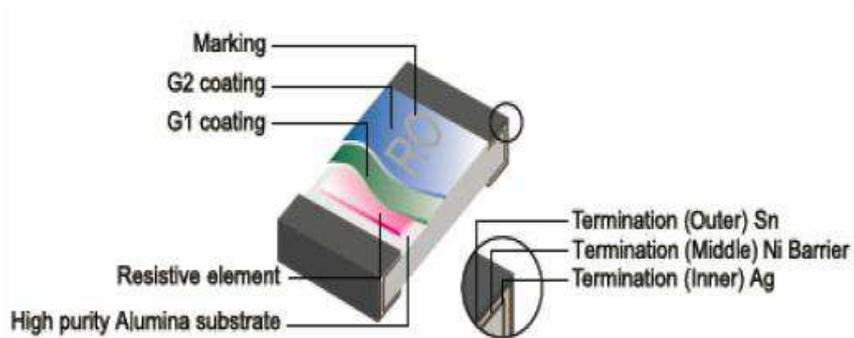

Type	Dimensions (mm)				
	L	W	H	ℓ1	ℓ2
3540	7.10 ± 0.20	4.20 ± 0.20	1.10 ± 0.10	0.60 ± 0.20	1.80 ± 0.20

Performance Specification

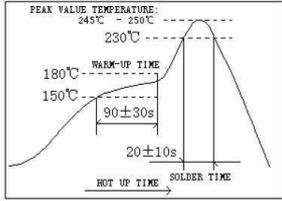
Characteristics	Limits	Test Methods (JIS C 5201-1)															
Dielectric Withstanding Voltage	No evidence of flashover, mechanical damage, arcing or insulation break down	4.7 Clamped in the trough of a 90°C metallic v-block and shall be tested at ac potential respectively specified in the type for 60-70 seconds															
Temperature Coefficient	1Ω~10Ω ≤± 200PPM/°C 10.1Ω~10MΩ ≤± 100PPM/°C	4.8 Natural resistance change per temp. degree centigrade. $\frac{R2-R1}{R1(t2-t1)} \times 106 \text{ (PPM/°C)}$ R1: Resistance value at room temperature (T1) R2: Resistance value at room temp. plus 100 °C(T2) Test pattern: room temp. (T1), room temp. +100°C(T2)															
Short Time Overload	Resistance change rate is: ± 5% (2.0% + 0.1Ω) Max. ± 1% (1.0% + 0.1Ω) Max.	4.13 Permanent resistance change after the application of a potential of 2.5 times RCWV for 5 seconds															
Solderability	95 % coverage Min.	Wave Solder: Test temperature of solder: 245°C ±3°C dipping time in solder : 2-3 seconds. Reflow 															
Soldering heat	Resistance change rate is: ± (1.0%+0.05Ω) Max.	4.18 Dip the resistor into a solder bath having a temperature of 260°C±3°C and hold it for 10±1 seconds.															
Temperature Cycling	Resistance change rate is: ± 5% (1.0% + 0.1Ω) Max. ± 1% (0.5% + 0.1Ω) Max.	4.19 Resistance change after continuous 5 cycles for duty cycle specified below: <table border="1"> <thead> <tr> <th>Step</th> <th>Temp.</th> <th>Time</th> </tr> </thead> <tbody> <tr> <td>1</td> <td>-55°C ± 3°C</td> <td>30m</td> </tr> <tr> <td>2</td> <td>Room temp.</td> <td>10~15m</td> </tr> <tr> <td>3</td> <td>+155°C ± 2°C</td> <td>30m</td> </tr> <tr> <td>4</td> <td>Room temp.</td> <td>10~15m</td> </tr> </tbody> </table>	Step	Temp.	Time	1	-55°C ± 3°C	30m	2	Room temp.	10~15m	3	+155°C ± 2°C	30m	4	Room temp.	10~15m
Step	Temp.	Time															
1	-55°C ± 3°C	30m															
2	Room temp.	10~15m															
3	+155°C ± 2°C	30m															
4	Room temp.	10~15m															
Humidity	Resistance change rate is: ± 5% (3.0% + 0.1Ω) Max. ± 1% (0.5% + 0.1Ω) Max.	4.24 Temporary resistance change after 240 hours exposure in a humidity test chamber controlled at 40±2°C and 90-95% relative humidity															

Performance Specification (Cont.)

Characteristics	Limits	Test Methods (JIS C 5201-1)
Load life in humidity	Resistance change rate is: ± 5% (3.0% + 0.1Ω) Max. ± 1% (1.0% + 0.1Ω) Max.	7.9 Resistance change after 1,000 hours (1.5 hours "on", 0.5 hour "off") at RCWV in a humidity chamber controlled at 40°C ± 2°C and 90 to 95 % relative humidity
Load Life	Resistance change rate is: ± 5% (3.0% + 0.1Ω) Max. ± 1% (1.0% + 0.1Ω) Max.	4.25.1 Permanent resistance change after 1,000 hours operating at RCWV, with duty cycle of (1.5 hours "on", 0.5 hour "off") at 70°C ± 2°C ambient
Terminal bending	Resistance change rate is: ± (1.0% + 0.05Ω) Max.	4.33 Twist of Test Board: Y/X = 3/90 mm for 60 seconds

Marking

A. 4 digit marking for E-96 series:

*The first 3 digits are significant figures of resistance and the 4th digit denoted number of zeros.

Ex.

	1273	
--	-------------	--

 127KΩ

*For ohmic values below 100 Ω, letter "R" is for decimal point.

Ex.

	49R9	
--	-------------	--

 49.9Ω

B. 3 digit marking for E-24 series:

*The first 2 digits are significant figures of resistance and the 3rd digit denoted number of zeros

Ex.

	124	
--	------------	--

 120KΩ

*For ohmic values below 10 Ω, letter "R" is for decimal point

Ex.

	4R7	
--	------------	--

 4.7Ω

Soldering

PCB Plan (mm)

4 layers PCB specification:

- 1) Outside 2 layers (Top and Bottom) with copper foil thickness at 2oz.
- 2) Inside 2 layers (Middle layers) with copper foil thickness at 4 oz.

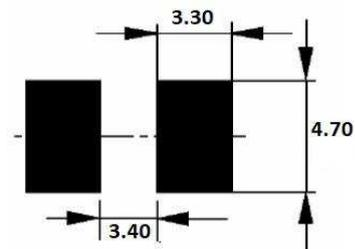

Soldering

Reflow solder profile

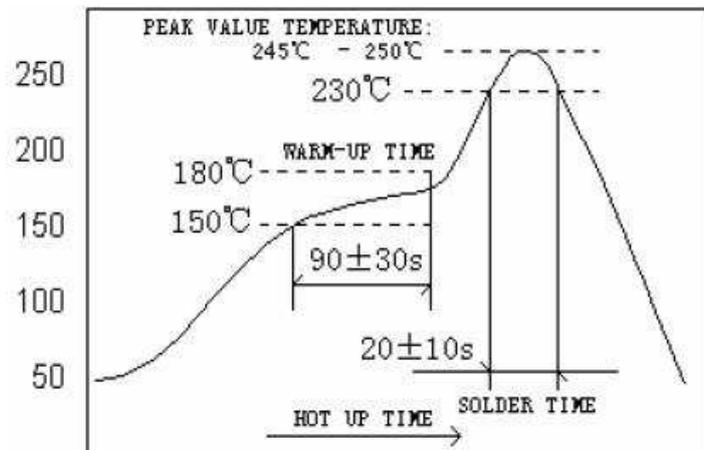

Packaging

Tape and Reel

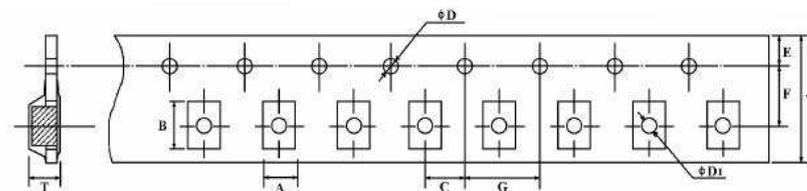

(mm)

A ±0.1	B ±0.1	C ±0.15	∅D +0.1 -0	E ±0.1	F ±0.15	G ±0.1	W ±0.3	∅D1 ±0.1	T ± 0.1
4.50	7.40	2.0	1.5	1.75	7.5	4.0	16	-	1.35

Peeling Strength of Top Cover Tape

Test Condition: 0.1 to 0.7 N at a peel-off speed of 300 mm / min.

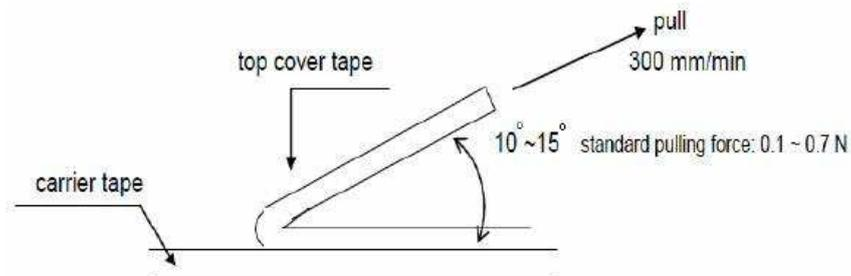

Reel Dimensions

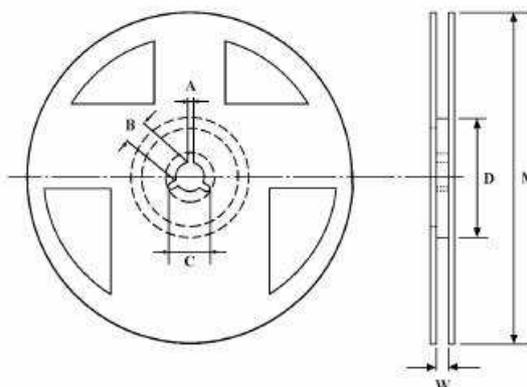

Qty Reel	A±0.5	B±0.5	C±0.5	D±1	M±2	W±1
2000	2.0	13.0	21	60.0	178	17.5

Environment Related Substance

This product complies to EU RoHS directive, EU PAHs directive, EU PFOS directive and Halogen free.

Storage Condition

The performance of these products, including the solderability, is guaranteed for a year from the date of arrival at your company, provided that they remain packed as they were when delivered and stored at a temperature of $25^{\circ}\text{C} \pm 10^{\circ}\text{C}$ and a relative humidity of $60\%RH \pm 10\%RH$, chemical and dust free atmosphere.

Even within the above guarantee periods, do not store these products in the following conditions:

1. In salty air or in air with a high concentration of corrosive gas, such as Cl_2 , H_2S , NH_3 , SO_2 , or NO_2
2. In direct sunlight

How To Order

3540	1R0	F	T
Common Part	Resistance Value	Tolerance	Pack Style
3540 – 4W 2817 Resistor	1 Ω - 1R0 100 Ω - 100R 1K Ω - 1K0	F – 1% J – 5%	T- 2000 per reel

X-ON Electronics

Largest Supplier of Electrical and Electronic Components

Click to view similar products for [Thick Film Resistors - SMD category:](#)

Click to view products by [TE Connectivity manufacturer:](#)

Other Similar products are found below :

[CR-05FL7--19K6](#) [CR-05FL7--243R](#) [CR-05FL7--40K2](#) [CR-12JP4--680R](#) [CRCW06036K80FKEE](#) [M55342K06B2E94RS2](#)
[M55342K06B309DRS3](#) [M55342K06B6E81RS3](#) [M55342K08B100DRWB](#) [M55342M05B200DRWB](#) [MC0603-511-JTW](#) [742C083750JTR](#)
[MCR01MZPF1202](#) [MCR01MZPF1601](#) [MCR01MZPF1800](#) [MCR01MZPF6201](#) [MCR01MZPF9102](#) [MCR01MZPJ113](#) [MCR01MZPJ121](#)
[MCR01MZPJ125](#) [MCR01MZPJ203](#) [MCR01MZPJ751](#) [MCR01MZPJ822](#) [MCR03EZHJ103](#) [MCR03EZPF1272](#) [MCR03EZPJ123](#)
[MCR03EZPJ270](#) [MCR03EZPJ821](#) [MCR10EZPF1102](#) [MCR10EZPF2003](#) [MCR10EZPF2700](#) [MCR18EZPJ330](#) [RC0603F1473CS](#)
[RC0603F150CS](#) [RC1005F1152CS](#) [RC1005F1182CS](#) [RC1005F1372CS](#) [RC1005F183CS](#) [RC1005F1911CS](#) [RC1005F1912CS](#)
[RC1005F203CS](#) [RC1005F2052CS](#) [RC1005F241CS](#) [RC1005F2431CS](#) [RC1005F3011CS](#) [RC1005F303CS](#) [RC1005F4321CS](#)
[RC1005F4642CS](#) [RC1005F471CS](#) [RC1005F4751CS](#)