

T90 series

30 Amp Printed Circuit Board Relay

File E22575

File LR15734

Patented

Users should thoroughly review the technical data before selecting a product part number. It is recommended that user also seek out the pertinent approvals files of the agencies/laboratories and review them to ensure the product meets the requirements for a given application.

Features

- Up to 30A switching in SPST and 20A switching in SPDT arrangements.
- Silver cadmium oxide contacts.
- Available as an open-frame relay, with a snap-on dust cover or with an immersion cleanable⁽⁶⁾, plastic sealed case.
- Meets UL 508 & UL 873 spacing – 1/8" through air, 1/8" over surface. (1/4" over surface with terminal code 4)
- UL class F insulation standard.
- Well suited for various industrial, commercial and residential applications, as well as many others.

Contact Ratings @ 25°C

Arrangements: 1 Form A (SPST-NO) and 1 Form C (SPDT).

Material: Silver-cadmium oxide.

Mechanical Life: 10 million operations, typical.

Contact Ratings @ 25°C with relay properly vented. Remove vent nib after soldering and cleaning.

Typical Electrical Load & Life (Open Style Relay)

Form & Contact Material	Contact Load	Type of Load	Ops
(1) Silver-cadmium oxide	30A @ 240VAC	UL General Purpose	100,000
	20A @ 240VAC	Resistive Heater	100,000
(5) Silver-cadmium oxide	20A/10A @ 240VAC	UL General Purpose	100,000
	20A/10A @ 28VDC	Resistive	100,000

Minimum Contact Load:

Silver Contacts: 500mA @ 5VDC or 12VAC.

Silver Cadmium Oxide Contacts: 1A @ 5VDC or 12VAC.

Initial Contact Resistance: 75 mΩ, max., @ min. rated current (switched).

Initial Dielectric Strength

Between Open Contacts: 1,500V rms.

Between Contacts and Coil: 1,500V rms (terminal code 1).
2,500V rms (UL 873 version terminal code 4).

Initial Insulation Resistance

Between Mutually Insulated Elements: 10⁹ ohms, min., @ 500VDC, 25°C and 50% R.H.

Coil Data @ 25°C

Voltage: 5 to 110VDC.

Maximum Coil Power: 2.8 Watt

Maximum Coil Temperature⁽⁵⁾: Class F: 155°C.

Duty Cycle: Continuous.

Coil Data

Nominal Voltage (VDC)	Resistance ± 10% (Ohms)	Nominal Power (mW)	Nominal Current (mA)
5	27	930	185
6	40	900	150
9	97	840	93
12	155	930	77
15	256	880	59
18	380	850	47
24	660	870	36
48	2,560	900	19
110	13,450	900	8

Operate Data @ 25°C

Must Operate Voltage: 75% of nominal voltage or less.

Must Release Voltage: 10% of nominal voltage or more.

Operate Time (Including Bounce)†: 15 ms, max.

Release Time (Including Bounce)†: 15 ms, max.

† At or From Nominal Coil Voltage

Typical Coil Temperature Rise

Data below are average values and should be verified in application. Tests were conducted within a 2' (.6 m) cube (still air) with relay mounted to a 30A, single side P.C. board⁽⁶⁾; at nominal coil power @ 25°C; with normally open contact loaded; and with 4' (1.22 m) long, #10 AWG load wires.

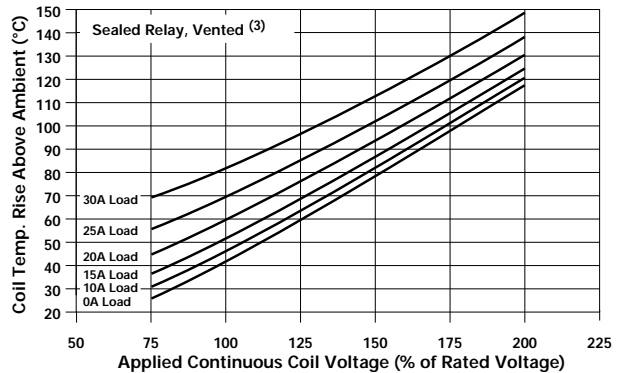
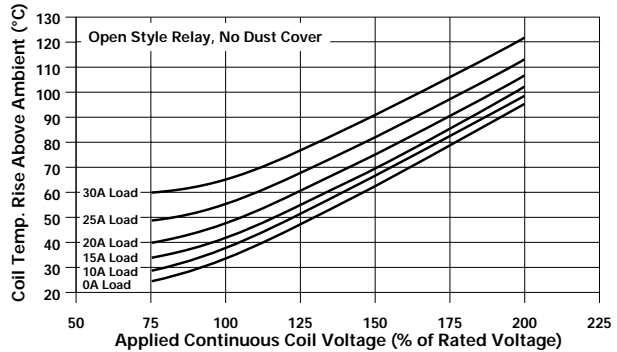

Environmental Data

Storage Temperature Range: -40°C to 130°C.

Operating Temperature Range: -55°C to +85°C⁽¹⁾.

Vibration, Operational: 0.065" (1.65mm) max. excursions from 10-55 Hz. with no contact opening >100μs.

Shock, Operational: 10g for 11 ms with no contact opening >100μs.

Shock, Mechanical: 100g.

Mechanical Data

Termination: Printed circuit terminals⁽⁴⁾.

Enclosures (all have 94V-0 flammability rating, Class F temp. rating):

Optional dust cover: Snap-on plastic dust cover is available for use on open style T90N.

Sealed case (T90S): Immersion cleanable, sealed plastic case⁽²⁾.

Weight: Open Model T90N: 0.7 oz. (20g) approximately.

Sealed Model T90S: 0.9 oz. (26g) approximately.

Notes

(1) Operating ambient temperature must consider "Must Operate Voltage Change Over Temperature," Contact Temperature Rise, Coil Temperature Rise (If coil is not allowed to cool) and Maximum Coil Temperature. Specification ambient considers nominal coil voltage, 20A load with coil cooled to ambient.

(2) Sealed relay terminals should not be bent.

(3) Knock-off nib should be removed after cleaning process for optimum life of sealed relays.

(4) Maximum soldering temperature is 500°F for 4 seconds.

(5) Class F coils are UL systems approved for maximum coil temperature of 155°C by change of resistance method.

(6) See application note 13C265 for proper relay mounting, termination, cleaning and PC board conductor width. Coil rise test performed with 30A PC board to maintain 20°C maximum rise @ 30A.

Ordering Information

Typical Part Number ▶	T90	S	5	D	1	2	-24
<p>1. Basic Series: T90 = Printed circuit board power relay.</p> <p>2. Enclosure: N = Open, no cover (snap-on dust cover available as an option). S = Immersion cleanable, sealed plastic case with knock-off nib for ventilation.</p> <p>3. Contact Arrangement: 1 = 1 Form A (SPST-NO). 5 = 1 Form C (SPDT).</p> <p>4. Coil Input: D = DC Voltage.</p> <p>5. Terminals: 1 = Printed circuit terminals. 4 = Printed circuit terminals, no common terminal between coil terminals (see wiring diagram). Note: Terminal code 4 recommended for UL 873 applications. Consult factory for use of terminal code 1 for UL 873 applications.</p> <p>6. Contact Material: 2 = Silver-cadmium oxide.</p> <p>7. Coil Voltage: 5 = 5V DC 6 = 6V DC 9 = 9V DC 12 = 12V DC 15 = 15V DC 18 = 18V DC 24 = 24V DC 48 = 48V DC 110 = 110V DC</p>							

Our authorized distributors are more likely to maintain the following items in stock for immediate delivery.

T90N1D12-12	T90N1D42-24	T90N5D42-24	T90S1D42-24	T90S5D42-24
T90N1D12-18	T90N5D12-12	T90S1D12-12	T90S5D12-12	
T90N1D12-24	T90N5D12-24	T90S1D12-24	T90S5D12-24	

Outline Dimensions

T90N

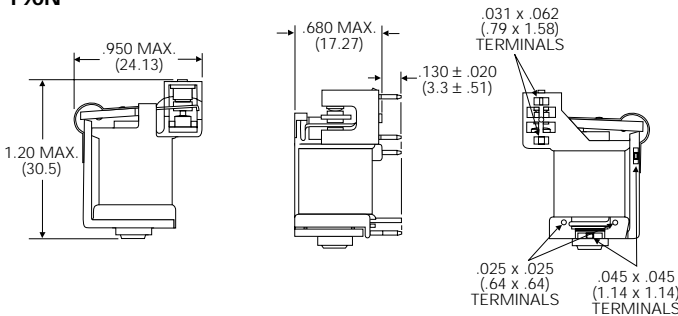

T90S

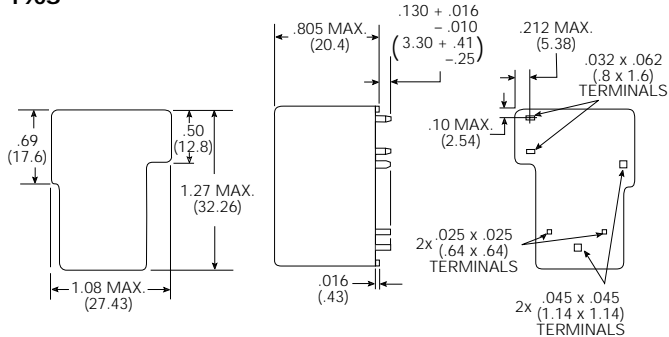

Optional Dust Cover For Use With Open-Style Relays

Optional plastic dust cover is a snap-on unit, open on the PC board side of the relay. The cover, when ordered with the relay, is shipped separately. It is designed to be snapped into place by the customer after the relay has been assembled to the PC board.

Cover Ordering Information – Boldface items are stocked.

Part No.	Description
35C620A	Black dust cover for use on open-style, T90N relay.

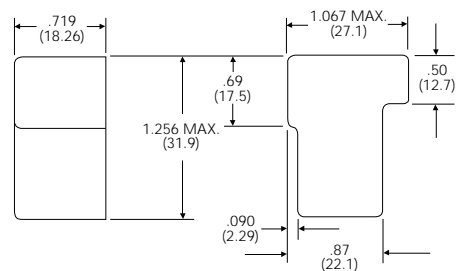

Wiring Diagram & PC Board Layout (Bottom Views)

1 Form C
(Unused terminals are not present)

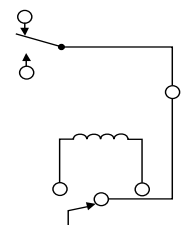

Note: This terminal not present with terminal code 4.

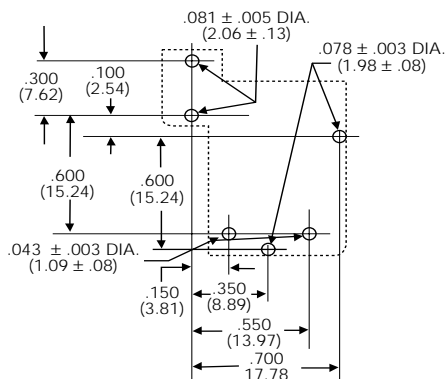

UL & CSA Contact Ratings

Voltage	Load Type	N.O. Contact	N. C. Contact
Silver Contacts			
240VAC	General Purpose	10A	5A
240VAC	Resistive	10A	5A
28VDC	Resistive	10A	5A
Silver-Cadmium Oxide Contacts			
240VAC	General Purpose†	30A	15A
240VAC	UL Resistive†	20A	15A
120VAC	Motor	1 HP	1/4 HP
240VAC	Motor	2 HP	1/2 HP
240VAC	LRA/FLA†	80/30	30/10
240VAC	Tungsten	TV5	TV3
277VAC	Ballast	6A	3A
28VDC	Resistive	20A	10A

† For Form C application, derate current to 67%.

X-ON Electronics

Largest Supplier of Electrical and Electronic Components

Click to view similar products for [Relay Sockets & Fixings](#) category:

Click to view products by [TE Connectivity](#) manufacturer:

Other Similar products are found below :

[00008258500](#) [00111976502](#) [0000-825-81-00](#) [60SY4S05](#) [M41G](#) [670-0125](#) [670-0127](#) [6700152](#) [670-0153](#) [6700156](#) [D258-2TS00](#) [70-309](#) [7-1393143-3](#) [7-1616360-5](#) [8000-DG2-5](#) [911361](#) [9-1616339-5](#) [PJF11N](#) [GDA12HA](#) [GDA12HD](#) [GDA12SA](#) [GDA12SD](#) [GDA16HD](#) [GDA22HA](#) [GDA95A](#) [GDA95D](#) [GFX20](#) [PT08QN](#) [PT 1/8 D = 3.2](#) [GUA1](#) [GUA2-11](#) [GUA4-04](#) [GUA4-31](#) [GUM5R](#) [GUR-120](#) [GUR-24](#) [GUR-240](#) [GUR-277](#) [GURX-277](#) [GUW12](#) [GUW95](#) [GUZ63L](#) [R99-11 FOR MY\(NAMEPLATE\)](#) [D52PR2T](#) [RES100K](#) [1310H-HDC](#) [1390H-1ST](#) [1393824-3](#) [1390H-2PC](#) [1410-2SM](#)