

**PRD Series Power Relay**

- Contact ratings to 50A
- Magnetic blowouts available for switching DC loads
- Contact arrangement up to 2 form C (2CO)
- 1 form C auxiliary switch available
- UL class B insulation

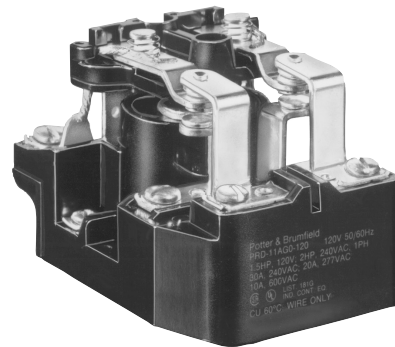

Typical applications  
Industrial controls, lighting.

**Approvals**

UL E22575; CSA LR15734;  
Models with all screw terminals are UL Listed. Others are UL Recognized.  
Technical data of approved types on request.

**Contact Data**

|                               |   |
|-------------------------------|---|
| Contact arrangement           | 1 and 2 form A (NO); 1 and 2 form C (CO);<br>1 form X (NO-DM) |
| Rated voltage                 | 600VAC, 125VDC  |
| Rated current                 | 50A   |
| Contact material              | Ag, AgCdO, W  |
| Min. recommended contact load | 1A, 12VDC or 12VAC  |
| Initial contact resistance    | 75mΩ max.   |
| Initial voltage drop          | 75mV  |
| Frequency of operation        | 7200 ops/hr   |
| Operate/releases time max.    | 40/20ms   |
| Bounce time max.              | 10ms  |

**Contact ratings**

| Type  | Load                   | Cycles              |
|---|------------------------|---------------------|
| <b>UL 508<sup>1)</sup></b>                              |                        |                     |
| Models with screws or quick connects for main terminals |                        |                     |
| Code Y, Ag, 1 pole                                      |                        |                     |
|   | 25A, 277VAC            | 100x10 <sup>3</sup> |
|   | 1HP, 120VAC            | 100x10 <sup>3</sup> |
|   | 2HP, 250VAC            | 100x10 <sup>3</sup> |
|   | 10A, 600VAC            | 100x10 <sup>3</sup> |
|   | 7A, 50VDC, resistive   | 100x10 <sup>3</sup> |
| Code Y, Ag, 2 pole                                      |                        |                     |
|   | 25A, 240VAC            | 100x10 <sup>3</sup> |
|   | 20A, 277VAC            | 100x10 <sup>3</sup> |
|   | 1HP, 120VAC            | 100x10 <sup>3</sup> |
|   | 2HP, 250VAC            | 100x10 <sup>3</sup> |
|   | 7A, 50VDC, resistive   | 100x10 <sup>3</sup> |
|   | 10A, 600VAC            | 100x10 <sup>3</sup> |
| Code G, AgCdO, 1 pole                                   |                        |                     |
|   | 30A, 277VAC, resistive | 100x10 <sup>3</sup> |
|   | 1.5HP, 120VAC          | 100x10 <sup>3</sup> |
|   | 2HP, 250VAC            | 100x10 <sup>3</sup> |
|   | 10A, 600VAC            | 100x10 <sup>3</sup> |
| Code G, AgCdO, 2 pole                                   |                        |                     |
|   | 30A, 240VAC            | 100x10 <sup>3</sup> |
|   | 20A, 277VAC            | 100x10 <sup>3</sup> |
|   | 1.5HP, 120VAC          | 100x10 <sup>3</sup> |
|   | 2HP, 250VAC            | 100x10 <sup>3</sup> |
|   | 10A, 600VAC            | 100x10 <sup>3</sup> |

1) Any PRD relay deviating electrically or physically from the standard models in the table is not UL or CSA listed. All horsepower ratings are for single phase motors..

**Contact ratings (continued)**

| Type  | Load                                       | Cycles              |
|---|--|---------------------|
| <b>UL 508<sup>1)</sup></b>                              |  |                     |
| Models with screws or quick connects for main terminals |  |                     |
| Code F, AgCdO, 1 pole                                   |  |                     |
|   | 50A, 240VAC, general purpose <sup>2)</sup> | 20x10 <sup>3</sup>  |
|   | 30A, 277VAC, resistive                     | 100x10 <sup>3</sup> |
|   | 1.5HP, 120VAC                              | 100x10 <sup>3</sup> |
|   | 2HP, 250VAC                                | 100x10 <sup>3</sup> |
|   | 10A, 600VAC                                | 100x10 <sup>3</sup> |
| Code F, AgCdO, 2 pole                                   |  |                     |
|   | 50A, 240VAC, general purpose <sup>2)</sup> | 20x10 <sup>3</sup>  |
|   | 30A, 240VAC                                | 100x10 <sup>3</sup> |
|   | 20A, 277VAC                                | 100x10 <sup>3</sup> |
|   | 1.5HP, 120VAC                              | 100x10 <sup>3</sup> |
|   | 2HP, 250VAC                                | 100x10 <sup>3</sup> |
|   | 10A, 600VAC                                | 100x10 <sup>3</sup> |
| Code H, Ag with magnetic blowout, 1 or 2 pole           |  |                     |
|   | 20A, 125VDC                                | 100x10 <sup>3</sup> |
|   | 1/3HP, 125VDC                              | 100x10 <sup>3</sup> |
| Code J, AgCdO with magnetic blowout, 1 or 2 pole        |  |                     |
|   | 20A, 125VDC                                | 100x10 <sup>3</sup> |
|   | 1/3HP, 125VDC                              | 100x10 <sup>3</sup> |
| Code N, W stationary with AgCdO movable, 1 or 2 pole    |  |                     |
|   | 25A, 250VAC                                | 100x10 <sup>3</sup> |
|   | 1HP, 125VAC                                | 100x10 <sup>3</sup> |
|   | 2HP, 250VAC                                | 100x10 <sup>3</sup> |

**UL 508<sup>1)</sup>**

|   |                              |                     |
|---|------------------------------|---------------------|
| Models with box lugs for main terminals |                              |                     |
| Code P, Ag, 1 form X                    |                              |                     |
|   | 50A, 277VAC, general purpose | 100x10 <sup>3</sup> |
|   | 30A, 277VAC, ballast         | 6x10 <sup>3</sup>   |
|   | 15A, 277VAC, tungsten        | 6x10 <sup>3</sup>   |
|   | 102LRA, 17FLA, 240VAC        | 30x10 <sup>3</sup>  |
|   | 120LRA, 20FLA, 120VAC        | 30x10 <sup>3</sup>  |
|   | 1.5HP, 120VAC                | 30x10 <sup>3</sup>  |
|   | 3HP, 240VAC                  | 30x10 <sup>3</sup>  |

**Factory ratings**

|  |                       |                     |
|--|-----------------------|---------------------|
| Models with box lugs for main terminals    |                       |                     |
| Code R, Ag with magnetic blowout, 1 form X |                       |                     |
|  | 60A, 28VDC, resistive | 100x10 <sup>3</sup> |
|  | 30A, 125VDC           | 100x10 <sup>3</sup> |

Mechanical endurance DC Coil, 1x10<sup>6</sup> ops.; AC Coil 5x10<sup>5</sup> ops.

**Auxiliary Snap-Action Switch Contact Data**

|                     |                         |
|---------------------|-------------------------|
| Contact arrangement | 1 form C (CO)           |
| Rating              | 5A, 120VAC, 60Hz., 25°C |
| Contact material    | Ag                      |

**PRD Series Power Relay (Continued)**

**Coil Data**

|                                     |                            |
|-------------------------------------|----------------------------|
| Coil voltage range                  | 6 to 110VDC<br>6 to 480VAC |
| Coil insulation system according UL | Class B                    |

**Coil versions, DC coil**

| Coil code | Rated voltage VDC | Operate voltage VDC | Release voltage VDC | Coil resistance $\Omega \pm 10\%$ | Rated coil power W |
|-----------|-------------------|---------------------|---------------------|-----------------------------------|--------------------|
| 6         | 6                 | 4.5                 | 0.6                 | 18                                | 2                  |
| 12        | 12                | 9                   | 1.2                 | 71                                | 2                  |
| 24        | 24                | 18                  | 2.4                 | 288                               | 2                  |
| 48        | 48                | 36                  | 4.8                 | 1150                              | 2                  |
| 110       | 110               | 82.5                | 11                  | 6050                              | 2                  |

All figures are given for coil without preenergization, at ambient temperature +23°C.  
Other coil voltages on request.

**Coil versions, AC coil**

| Coil code | Rated voltage VAC | Operate voltage VAC | Release voltage VAC | Coil resistance $\Omega \pm 15\%$ | Rated coil power VA |
|-----------|-------------------|---------------------|---------------------|-----------------------------------|---------------------|
| 6         | 6                 | 5.1                 | 0.6                 | 0.86                              | 9.8                 |
| 12        | 12                | 10.2                | 1.2                 | 3.2                               | 9.8                 |
| 24        | 24                | 20.4                | 2.4                 | 12                                | 9.8                 |
| 120       | 120               | 102                 | 12                  | 290                               | 9.8                 |
| 240       | 240               | 204                 | 24                  | 1200                              | 9.8                 |
| 480       | 480               | 408                 | 48                  | 4500                              | 9.8                 |

All figures are given for coil without preenergization, at ambient temperature +23°C.  
Other coil voltages on request.

**Insulation Data**

|                               |                      |
|-------------------------------|----------------------|
| Initial dielectric strength   |                      |
| between open contacts         | 2000V <sub>rms</sub> |
| between contact and coil      | 2000V <sub>rms</sub> |
| between adjacent contacts     | 2000V <sub>rms</sub> |
| Initial insulation resistance |                      |
| between insulated elements    | 100M $\Omega$        |

**Other Data**

Material compliance: EU RoHS/ELV, China RoHS, REACH, Halogen content refer to the Product Compliance Support Center at [www.te.com/customer-support/rohssupportcenter](http://www.te.com/customer-support/rohssupportcenter)

Ambient temperature  
AC coil: -55°C to 45°C  
DC coil: -55°C to 80°C

Category of environmental protection  
IEC 61810

RT0 - open relay

Terminal type Screw, Quick connects, Box lugs

Weight 284g

Packaging/unit tray/20 pcs., box/40pcs.

**Accessories**

| Product Code | Description      |
|--------------|------------------|
| 35D013       | Metal dust cover |

**Dimensions**

PRD/PRDA 1, 3, 5 and 7

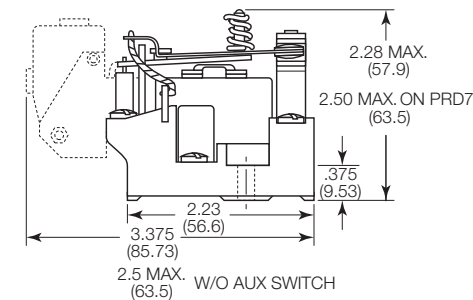
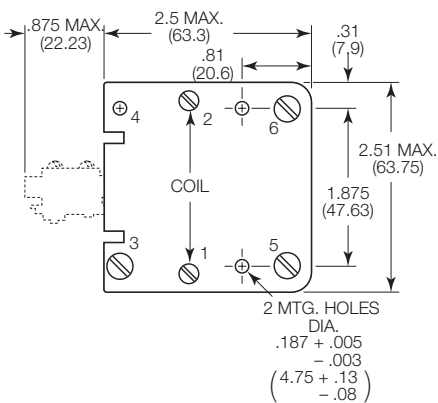

PRD/PRDA 11

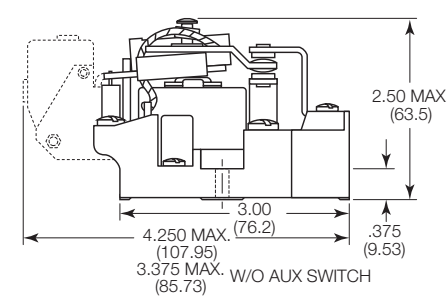
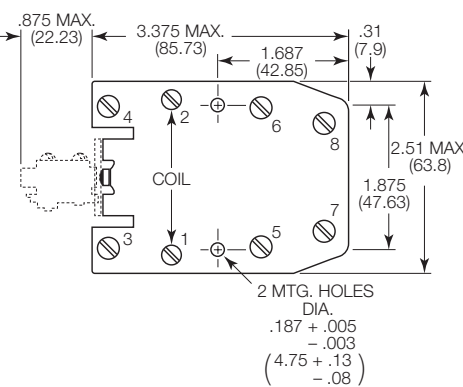

PRD-3\_P and R

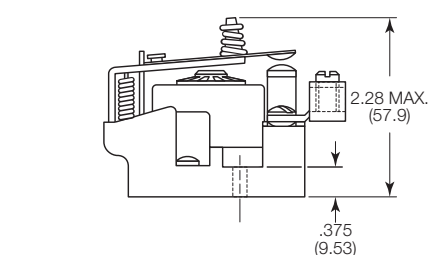
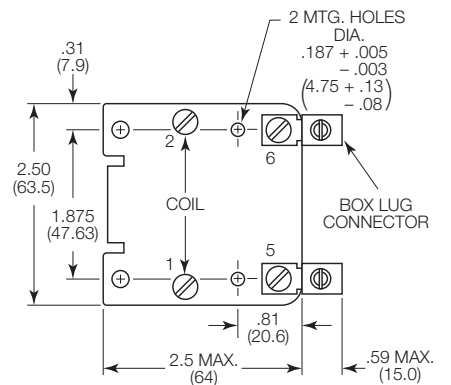



**PRD Series Power Relay (Continued)**

| Product Code   | Arrangement       | Material           | Coil       | Terminals  | Part Number |             |
|----------------|-------------------|--------------------|------------|------------|-------------|-------------|
| PRD-3AY0-120   | 1 form X, 1 NO-DM | Ag                 | 120VAC     | Screw      | 7-1393127-9 |             |
| PRD-3AG0-120   |                   | AgCdO, 30A         |            |            | 6-1393127-9 |             |
| PRD-3AJ0-120   |                   | AgCdO, mag blowout |            |            | 7-1393127-4 |             |
| PRD-3AJ3-24    | 1 form C, 1 CO    |                    | 24VAC      | Screw / QC | 7-1393127-5 |             |
| PRD-3DH0-24    |                   | Ag, mag blowout    | 24VDC      | Screw      | 8-1393127-6 |             |
| PRD-3DY0-12    |                   | Ag                 | 12VDC      |            | 9-1393127-5 |             |
| PRD-3DY0-24    |                   |                    | 24VDC      |            | 9-1393127-6 |             |
| PRD-3DY0-110   |                   |                    |            | 110VDC     |             | 9-1393127-4 |
| PRD-5AY0-24    |                   |                    |            | 24VAC      |             | 1393128-6   |
| PRD-5AY0-120   |                   |                    | 120VAC     |            | 1393128-5   |             |
| PRD-5AY1-120   |                   |                    |            | QC         | 1-1393128-1 |             |
| PRD-5AY0-240   |                   |                    | 240VAC     | Screw      | 1393128-7   |             |
| PRD-5DF0-12    | 2 form A, 2 NO    | AgCdO, 50A         | 12VDC      |            | 2-1423100-4 |             |
| PRD-5DY0-12    |                   | Ag                 |            |            | 1-1393128-6 |             |
| PRD-5DY0-24    |                   |                    | 24VDC      |            | 1-1393128-7 |             |
| PRD-7AG0-120   |                   |                    | AgCdO, 30A | 120VAC     |             | 9-1393129-5 |
| PRD-7AY0-24    |                   |                    | Ag         | 24VAC      |             | 1393130-9   |
| PRD-7AY0-120   |                   |                    |            | 120VAC     |             | 1393130-7   |
| PRD-7AY0-240   |                   |                    | 240VAC     |            | 1-1393130-0 |             |
| PRD-7AY3-120   |                   |                    | 120VAC     | Screw / QC | 1-1393130-2 |             |
| PRD-7DG0-24    | 2 form C, 2 CO    | AgCdO, 30A         | 24VDC      | Screw      | 1-1393130-6 |             |
| PRD-7DH0-48    |                   | Ag, mag blowout    | 48VAC      |            |             | 2-1393130-1 |
| PRD-7DY0-12    |                   | Ag                 | 12VDC      |            | 2-1393130-8 |             |
| PRD-7DY0-24    |                   |                    | 24VDC      |            | 2-1393130-9 |             |
| PRD-11AF0-240  |                   |                    | AgCdO, 50A | 240VAC     |             | 3-1423100-0 |
| PRD-11AG0-24   |                   |                    | AgCdO, 30A | 24VAC      |             | 1-1393127-1 |
| PRD-11AG0-120  |                   |                    | 120VAC     |            | 1393127-9   |             |
| PRD-11AG0-240  |                   |                    | 240VAC     |            | 1-1393127-2 |             |
| PRD-11AH0-120  |                   | Ag, mag blowout    | 120VAC     |            | 1-1393127-6 |             |
| PRD-11AY0-24   |                   | Ag                 | 24VAC      |            | 2-1393127-9 |             |
| PRD-11AY0-120  |                   |                    | 120VAC     |            | 2-1393127-6 |             |
| PRD-11AY0-240  |                   |                    | 240VAC     |            | 3-1393127-0 |             |
| PRD-11AY0-480  |                   |                    | 480VAC     |            | 3-1393127-1 |             |
| PRD-11DF0-12   |                   | AgCdO, 50A         | 12VDC      |            | 2-1423100-2 |             |
| PRD-11DF0-110  |                   |                    | 110VDC     |            | 2-1423100-9 |             |
| PRD-11DG0-12   |                   | AgCdO, 30A         | 12VDC      |            | 3-1393127-5 |             |
| PRD-11DG0-24   |                   |                    | 24VDC      |            | 3-1393127-8 |             |
| PRD-11DH0-12   |                   | Ag, mag blowout    | 12VDC      |            | 4-1393127-7 |             |
| PRD-11DH0-24   |                   |                    | 24VDC      |            | 4-1393127-9 |             |
| PRD-11DH0-48   |                   |                    | 48VDC      |            | 5-1393127-0 |             |
| PRD-11DH0-110  |                   |                    | 110 VDC    |            | 4-1393127-6 |             |
| PRD-11DJ0-24   |                   | AgCdO, mag blowout | 24 VDC     |            | 5-1393127-5 |             |
| PRD-11DY0-12   |                   | Ag                 | 12 VDC     |            | 6-1393127-1 |             |
| PRD-11DY0-24   |                   |                    | 24 VDC     |            | 6-1393127-2 |             |
| PRD-11DY0-48   |                   |                    | 48 VAC     |            | 6-1393127-3 |             |
| PRD-11DY0-110  |                   |                    | 110 VDC    |            | 6-1393127-0 |             |
| PRDA-11AGA-120 |                   | AgCdO, 30A         | 120 VAC    |            | 7-1393131-4 |             |
| PRDA-11AYA-120 |                   |                    |            |            | 7-1393131-9 |             |

**PRD accessory**

| Product Code | Description                | Part Number |
|--------------|----------------------------|-------------|
| 35D013       | Metal dust cover enclosure | 5-1393158-2 |



**35D013 Dust Cover**

PRD dust cover has a steel base with knockouts for 0.5" (12.7mm) dia. conduit and a cover fitted with two screws. Fits PRD relays, except with auxiliary contacts. Finished in gray baked enamel.

**Mounting:**  
Three No. 10 holes on 1.875" (47.63mm) x 4.125" (104.77mm) centers.

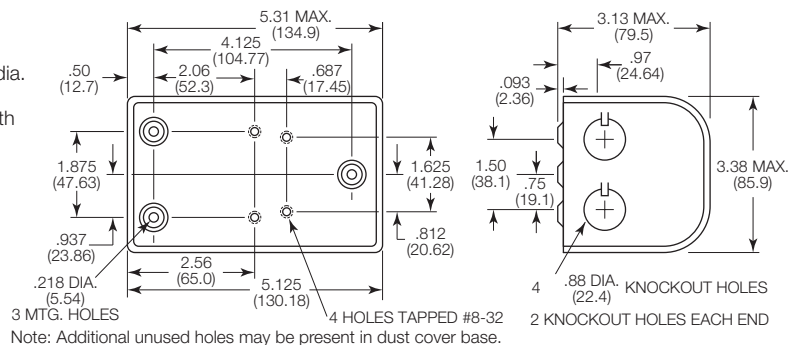

## X-ON Electronics

Largest Supplier of Electrical and Electronic Components

*Click to view similar products for [Relay Sockets & Fixings](#) category:*

*Click to view products by [TE Connectivity](#) manufacturer:*

Other Similar products are found below :

[00008258500](#) [00111976502](#) [0000-825-81-00](#) [60SY4S05](#) [M41G](#) [670-0125](#) [670-0127](#) [6700152](#) [670-0153](#) [6700156](#) [D258-2TS00](#) [70-309](#) [7-1393143-3](#) [7-1616360-5](#) [8000-DG2-5](#) [911361](#) [9-1616339-5](#) [PJF11N](#) [GDA12HA](#) [GDA12HD](#) [GDA12SA](#) [GDA12SD](#) [GDA16HD](#) [GDA22HA](#) [GDA95A](#) [GDA95D](#) [GFX20](#) [PT08QN](#) [PT 1/8 D = 3.2](#) [GUA1](#) [GUA2-11](#) [GUA4-04](#) [GUA4-31](#) [GUM5R](#) [GUR-120](#) [GUR-24](#) [GUR-240](#) [GUR-277](#) [GURX-277](#) [GUW12](#) [GUW95](#) [GUZ63L](#) [R99-11 FOR MY\(NAMEPLATE\)](#) [D52PR2T](#) [RES100K](#) [1310H-HDC](#) [1390H-1ST](#) [1393824-3](#) [1390H-2PC](#) [1410-2SM](#)