

General Purpose RFI Power Line Filters - Ideal for High Impedance Load

K Series

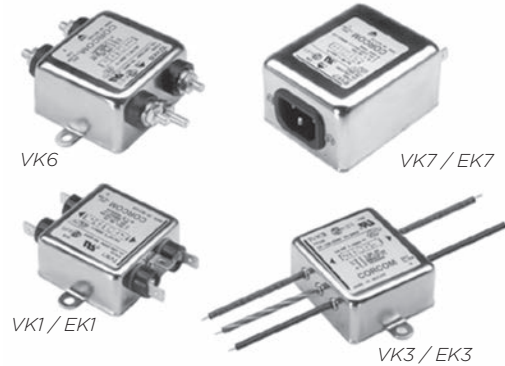

UL Recognized
CSA Certified
VDE Approved**



K Series

- Suitable for high impedance loads
- Well suited to applications where pulsed, continuous and/or intermittent RFI interference is present
- EK models meet the very low leakage current requirements for VDE portable equipment and non-patient care medical equipment
- Available with ground line inductor (choke)

Ordering Information

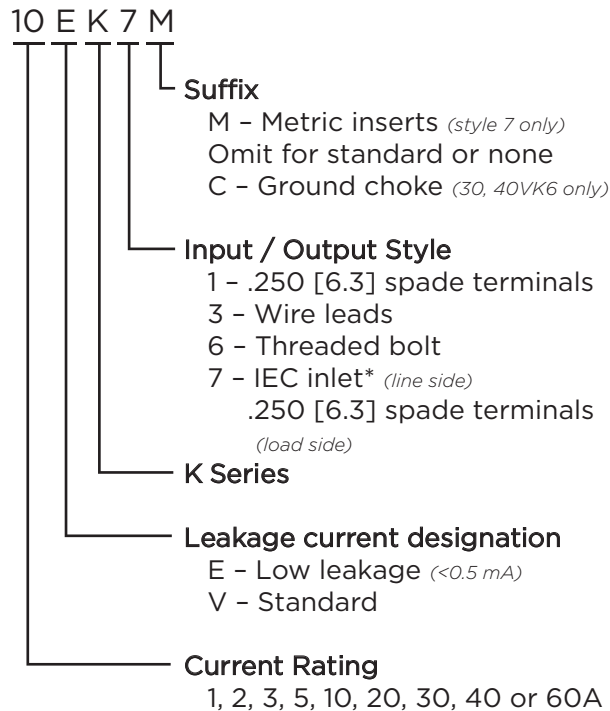

*1-15A: IEC 60320-1 C14 inlet mates with C13 connector
20VK7: C20 inlet mates with C19 connector

Specifications

Maximum leakage current each Line to Ground:

| | VK Models | EK Models |
|------------------|-----------|-----------|
| @ 120 VAC 60 Hz: | .5 mA | .21 mA |
| @ 250 VAC 50 Hz: | 1.0 mA | .36 mA |

Hipot rating (one minute):

| | |
|-----------------|----------|
| Line to Ground: | 2250 VDC |
| Line to Line: | 1450 VDC |

Rated Voltage (max):

250 VAC

Operating Frequency:

50/60 Hz

Rated Current:

1 to 60A*

Operating Ambient Temperature Range

(at rated current I_r): -10°C to +40°C
In an ambient temperature (T_a) higher than +40°C the maximum operating current (I_o) is calculated as follows: $I_o = I_r \sqrt{(85-T_a)/45}$

Available Part Numbers

| | | |
|-------|--------|--------|
| 1VK1 | 10VK6 | 2EK3 |
| 1VK3 | 10VK7 | 3EK1 |
| 2VK1 | 10VK7M | 3EK3 |
| 2VK3 | 20VK1 | 3EK7 |
| 3VK1 | 20VK6 | 3EK7M |
| 3VK3 | 20VK7* | 5EK1 |
| 3VK7 | 30VK6 | 5EK3 |
| 3VK7M | 30VK6C | 5EK7 |
| 5VK1 | 40VK6 | 5EK7M |
| 5VK3 | 40VK6C | 10EK1 |
| 5VK7 | 60VK6 | 10EK3 |
| 5VK7M | 1EK1 | 10EK7 |
| 10VK1 | 1EK3 | 10EK7M |
| 10VK3 | 2EK1 | 20EK1 |

**20VK7, 20A model tested by Underwriters Laboratories to US and Canadian requirements and is VDE approved at 16A, 250VAC

General Purpose RFI Power Line Filters *(continued)*

K Series

Electrical Schematics

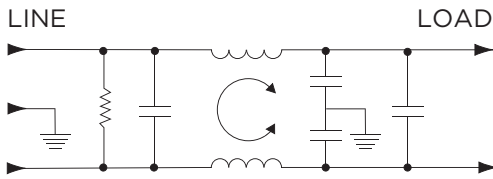

30 & 40VK6C *(Inductor in Ground Line)*

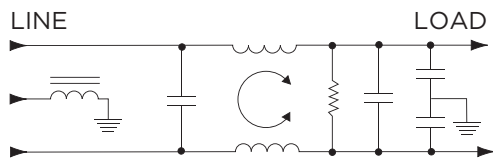

60VK6

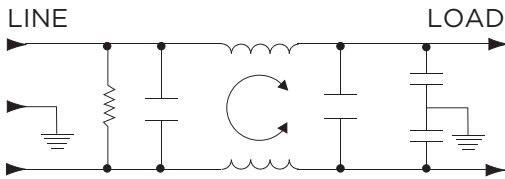

Accessories

GA400: NEMA 5-15P to IEC 60320-1 C-13 line cord

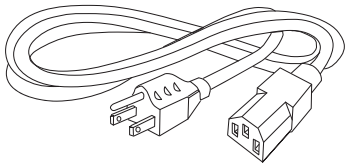

Case Styles

K1 (1, 2, 3, 6, 10A)

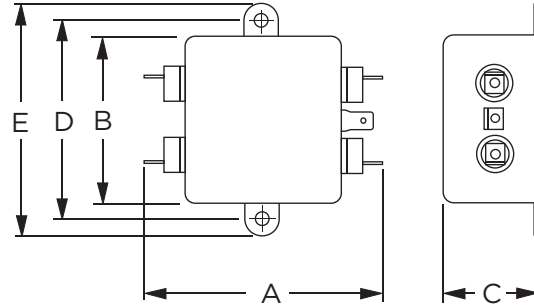

Typical Dimensions:
Line/Load Terminals (4): .250 [6.3] with .07 [1.8] Dia. hole
Ground Terminal (1): .250 [6.3] with .07 x .16 [1.8 x 3.8] slot
Mounting Holes (2): .188 [4.78] Dia.

K1 (20A)

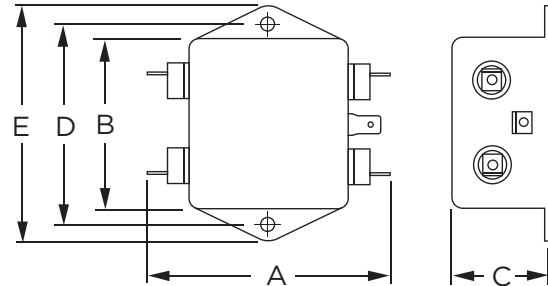

Typical Dimensions:
Line/Load Terminals (4): .250 [6.3] with .07 [1.8] Dia. hole
Ground Terminal (1): .250 [6.3] with .07 x .16 [1.8 x 3.8] slot
Mounting Holes (2): .188 [4.78] Dia.

K3

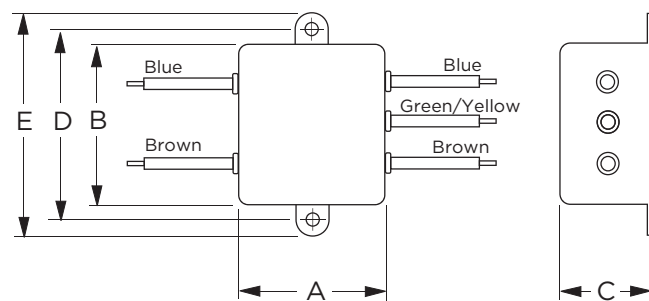

Typical Dimensions:
Wire Leads (5): 4.0 [101.6] Min., AWG18 (AWG16 for 10A)
Mounting Holes (2): .188 [4.78] Dia.

General Purpose RFI Power Line Filters (continued)

K Series

Case Styles (continued)

10VK6

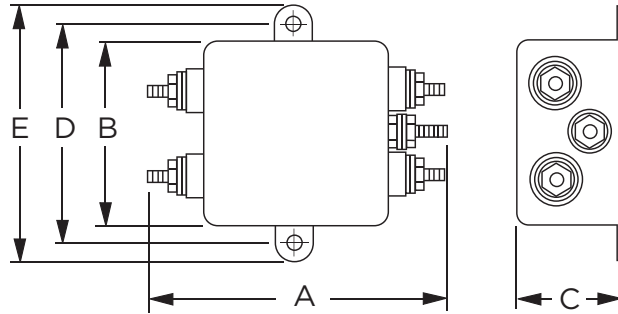

Typical Dimensions:
 Terminals (5): 8-32, Torque 18 lbf-in. [2.03 N-m] max. ± 2 [.22]
 Mounting Holes (2): .188 [4.78] Dia.

20VK6

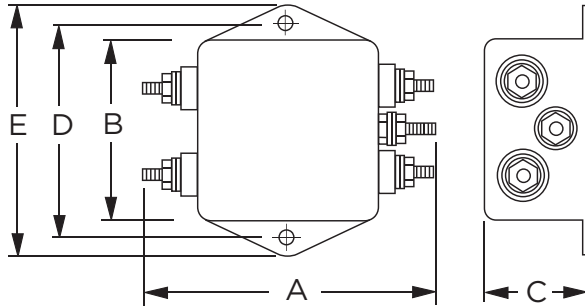

Typical Dimensions:
 Terminals (5): 8-32, Torque 18 lbf-in. [2.03 N-m] max. ± 2 [.22]
 Mounting Holes (2): .188 [4.78] Dia.

30VK6/6C & 40VK6/6C

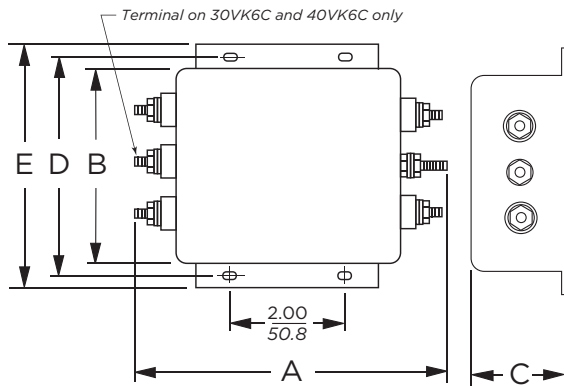

Typical Dimensions:
 Terminals (5): 8-32, Torque 18 lbf-in. [2.03 N-m] max. ± 2 [.22]
 Mounting Slots (4): .250 x .156 [6.35 x 3.96] Dia.

60VK6

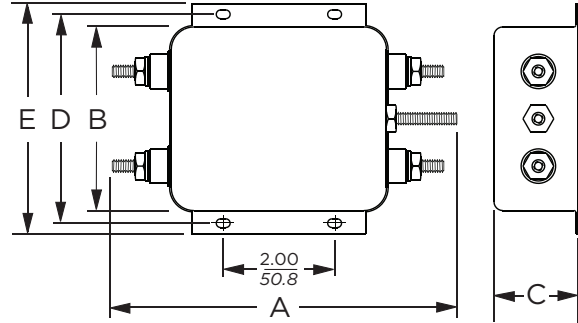

Typical Dimensions:
 Terminals (5): 1/4-20, Torque 56 lbf-in. [6.32 N-m] max. ± 2 [.22]
 Mounting Slots (4): .250 x .156 [6.35 x 3.96] Dia.

K7 & K7M (3, 5, 10A)

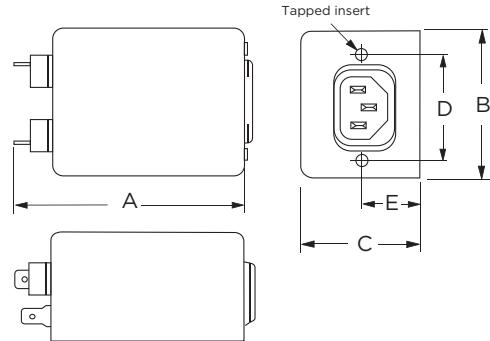

Typical Dimensions:
 Load Terminals (2): .250 [6.3] with .07 [1.8] Dia. hole
 Ground Terminal (1): .250 [6.3] with .07 x .16 [1.8 x 3.8] slot
 Line Inlet (1): IEC 60320-1 C14
 K7 Tapped Inserts (2): 6-32 x 1/4
 K7M Tapped Inserts (2): M3 x .5

20VK7

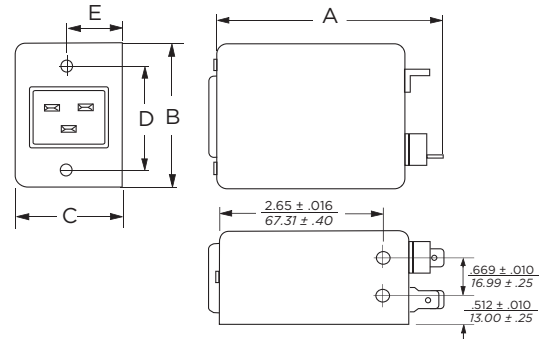

Typical Dimensions:
 Load Terminals (2): .250 [6.3] with .07 [1.8] Dia. hole
 Ground Terminal (1): .250 [6.3] with .07 x .16 [1.8 x 3.8] slot
 Line Inlet (1): IEC 60320-1 C20
 K7 Tapped Inserts (2): 6-32 x 1/4
 K7M Tapped Inserts (2): M3 x .5



RFI Power Line Filters

General Purpose RFI Power Line Filters (continued)

K Series

Case Dimensions

| Part No. | A (max) | B (max) | C (max) | D $\pm .015$ $\pm .38$ | E (max) |
|-------------|-------------|-------------|-------------|------------------------------|--------------|
| 1VK1, 1EK1, | 3.1 | 2.07 | 0.91 | 2.375 | 2.81 |
| 2VK1, 2EK1 | 78.7 | 52.6 | 23.1 | 60.33 | 74.1 |
| 1VK3, 1EK3, | 1.81 | 2.07 | 0.91 | 2.375 | 2.81 |
| 2VK3, 2EK3 | 46.0 | 52.6 | 23.1 | 60.33 | 74.1 |
| 3VK1, 3EK1, | 3.10 | 2.07 | 1.16 | 2.375 | 2.81 |
| 5VK1, 5EK1 | 78.7 | 52.6 | 29.5 | 60.33 | 74.1 |
| 3VK3, 3EK3, | 1.81 | 2.07 | 1.16 | 2.375 | 2.81 |
| 5VK5, 5EK3 | 46.0 | 52.6 | 29.5 | 60.33 | 74.4 |
| 3VK7/7M, | 3.21 | 2.25 | 1.28 | 1.575 | 0.63* |
| 3EK7/7M | 81.5 | 57.2 | 32.5 | 40.01 | 16.0' |
| 5VK7/7M, | 3.21 | 2.25 | 1.28 | 1.575 | 0.63* |
| 5EK7/7M | 81.5 | 57.2 | 32.5 | 40.01 | 16.0' |
| 10VK1, | 3.35 | 2.07 | 1.16 | 2.375 | 2.81 |
| 10EK1 | 85.1 | 52.6 | 29.5 | 60.33 | 71.4 |
| 10VK3, | 2.07 | 2.07 | 1.16 | 2.375 | 2.81 |
| 10EK3 | 52.6 | 52.6 | 29.5 | 60.33 | 71.4 |
| 10VK6 | 3.46 | 2.07 | 1.16 | 2.375 | 2.81 |
| | 87.9 | 52.6 | 29.5 | 60.33 | 71.4 |
| 10VK7/7M, | 3.71 | 2.25 | 1.28 | 1.575 | 0.63* |
| 10EK7/7M | 94.2 | 57.2 | 32.5 | 40.01 | 16.0' |
| 20VK1, | 3.35 | 2.56 | 1.53 | 2.938 | 3.35 |
| 20EK1 | 85.1 | 65.0 | 38.9 | 74.63 | 85.1 |
| 20VK6 | 3.46 | 2.56 | 1.53 | 2.938 | 3.35 |
| | 87.9 | 65.0 | 38.9 | 74.63 | 85.1 |
| 20VK7 | 3.8 | 2.28 | 1.78 | 1.575 | .846' |
| | 90.4 | 54.6 | 39.6 | 74.63 | 85.8' |
| 30VK6, | 5.34 | 3.38 | 1.53 | 3.75 | 4.20 |
| 30VK6C | 135.6 | 85.9 | 38.9 | 95.25 | 106.7 |
| 40VK6, | 5.34 | 3.38 | 1.53 | 3.75 | 4.20 |
| 40VK6C | 135.6 | 85.9 | 38.9 | 95.25 | 106.7 |
| 60VK6 | 6.0 | 3.38 | 1.53 | 3.75 | 4.20 |
| | 152.4 | 85.9 | 38.9 | 95.25 | 106.7 |

*±0.02 [0.5]
'±0.01 [0.25]

Recommended Panel Cutouts

K7 & K7M Cutout (3, 5, 10A)

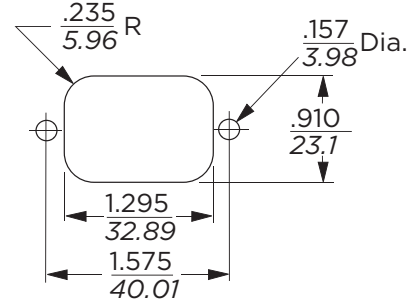

20VK7 Cutout

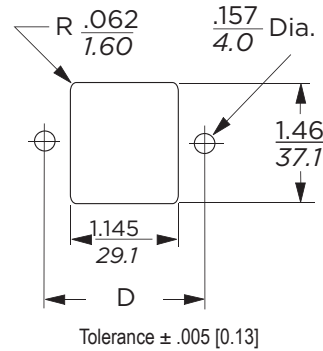

Performance Data

Typical Insertion Loss

Measured in closed 50 Ohm system

1 & 3EK

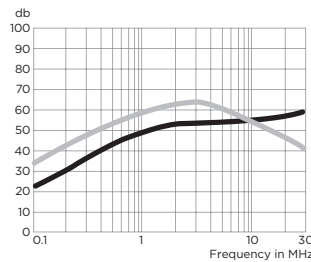

2 & 10EK

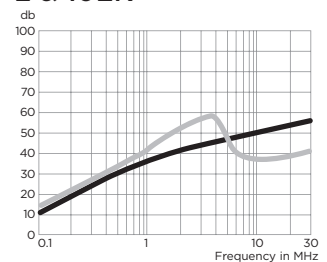

5EK

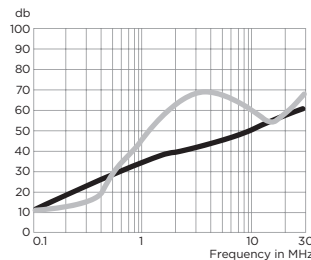

20EK

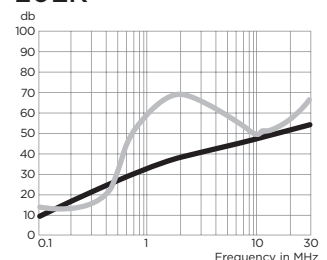

General Purpose RFI Power Line Filters (continued)

K Series

Performance Data (continued)

Typical Insertion Loss

Measured in closed 50 Ohm system

1VK

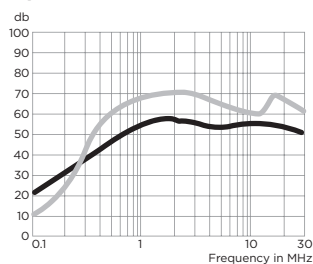

2VK

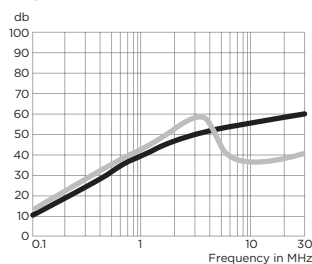

3VK

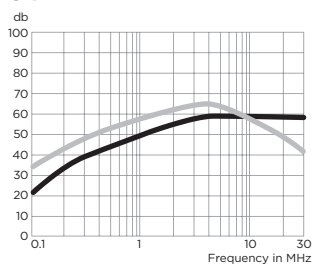

5VK

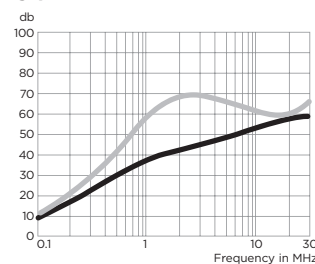

10VK

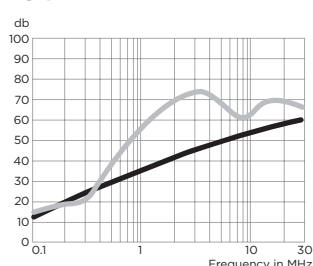

20VK

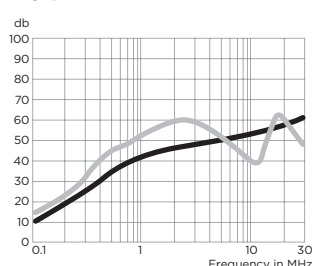

30VK & 30VK6C

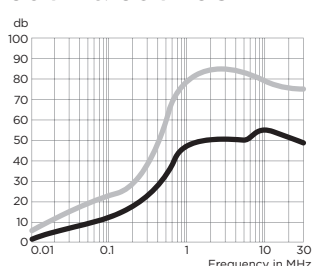

40VK & 40VK6C

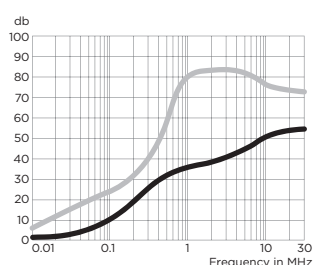

60VK

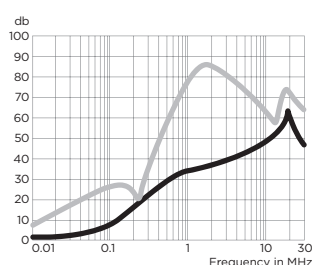

— Common Mode / Asymmetrical (L-G)
— Differential Mode / Symmetrical (L-L)

Minimum Insertion Loss

Measured in closed 50 Ohm system

Common Mode / Asymmetrical (Line to Ground)

| Current Rating | Frequency – MHz | | | | | |
|------------------|-----------------|----|----|----|----|----|
| | .15 | .5 | 1 | 5 | 10 | 30 |
| VK Models | | | | | | |
| 1A, 3A | 15 | 30 | 38 | 50 | 50 | 50 |
| 2A, 5A, 10A | 6 | 19 | 28 | 42 | 45 | 50 |
| 20A | 6 | 19 | 28 | 42 | 45 | 50 |
| 30A, 40A | 6 | 19 | 28 | 42 | 45 | 50 |
| 60A | 6 | 22 | 28 | 32 | 39 | 35 |
| EK Models | | | | | | |
| 1A, 3A | 15 | 29 | 35 | 45 | 45 | 50 |
| 2A, 5A, 10A | 8 | 19 | 25 | 38 | 40 | 45 |
| 20A | 8 | 19 | 25 | 38 | 40 | 45 |

Differential Mode / Symmetrical (Line to Line)

| Current Rating | Frequency – MHz | | | | | |
|------------------|-----------------|----|----|----|----|----|
| | .15 | .5 | 1 | 5 | 10 | 30 |
| VK Models | | | | | | |
| 1A, 3A | - | - | 48 | 55 | 50 | 35 |
| 2A, 5A, 10A | - | - | 30 | 50 | 30 | 30 |
| 20A | 6 | 6 | 30 | 50 | 30 | 30 |
| 30A, 40A | 2 | 40 | 60 | 65 | 57 | 55 |
| 60A | 13 | 49 | 67 | 57 | 53 | 53 |
| EK Models | | | | | | |
| 1A, 3A | - | - | 48 | 55 | 50 | 35 |
| 2A, 5A, 10A | - | - | 30 | 50 | 30 | 30 |
| 20A | 6 | 6 | 30 | 50 | 30 | 30 |

X-ON Electronics

Largest Supplier of Electrical and Electronic Components

Click to view similar products for [Power Line Filters](#) category:

Click to view products by [TE Connectivity](#) manufacturer:

Other Similar products are found below :

[5B1](#) [6609019-3](#) [6609026-5](#) [6609030-6](#) [6609063-2](#) [6609973-2](#) [7-1609090-5](#) [F1500CA06](#) [F7382Z](#) [F7863Z](#) [FAHAV3100ZC000](#) [806276](#)
[FN2020B-1-06](#) [FN2080B-10-06](#) [FN2090A-1-06](#) [FN2410H-32-33](#) [FN2410H-80-34](#) [FN2412H-16-44](#) [FN420-1-13](#) [FP144](#) [8-6609089-0](#) [12-](#)
[MMB-030-11-D](#) [B84144A0050R120](#) [B84144A90R120](#) [20B1](#) [RSEL-2001A](#) [2B1](#) [LP183](#) [1-6609070-1](#) [F1500CA10](#) [1B1](#) [FN2020A-10-06](#)
[FN2020B-3-06](#) [FN2060A-3-06](#) [FN2070A-16-06](#) [FN2070B-16-08](#) [FN2090A-20-06](#) [FN2090B-12-06](#) [FN2090Z-1-06](#) [FN2410H-25-33](#)
[FN2410H-60-34](#) [FN2410H-8-44](#) [FN2412H-25-33](#) [FN2412H-8-44](#) [FN610R-3-06](#) [20EHZ7](#) [20K1](#) [30B6](#) [30BCF10R](#) [3K1](#)