

THIS DRAWING IS UNPUBLISHED. RELEASED FOR PUBLICATION
 © COPYRIGHT - By - ALL RIGHTS RESERVED.

LOC	DIST	REVISIONS					
FT	0	P	LTR	DESCRIPTION	DATE	DWN	APVD
			F1	WIRE SIZE CORRECTION	05MAR2015	CR	PS

MATERIAL:
 HOUSING: THERMOPLASTIC, UL94V-0, BLACK.
 TERMINAL: M3 THREAD, BRIGHT TIN PLATED, COPPER ALLOY.
 SCREWS: M3 THREAD ZINC PLATED STEEL, EXCEPT WHERE OTHERWISE NOTED.

ELECTRICAL:
 RATED CURRENT: 10A.
 OPERATING VOLTAGE: 300V.
 WIRE RANGE: 18-22 AWG.

MECHANICAL:
 PITCH (TERMINAL SPACING): .250"
 OPERATING TEMP.: 120°C MAX.

- ① SEE FIGURE.
- ② M3 SCREWS, ZINC PLATED STEEL AND M3 THREADED TERMINAL.
- 3 RUNNING TORQUE: 4 IN-LB MAX.
- ④ OBSOLETE PARTS: OBSOLETE CIS STREAMLINING PER D.RENAUD/D.SINISI
- ⑤ PRELIMINARY PART NUMBER

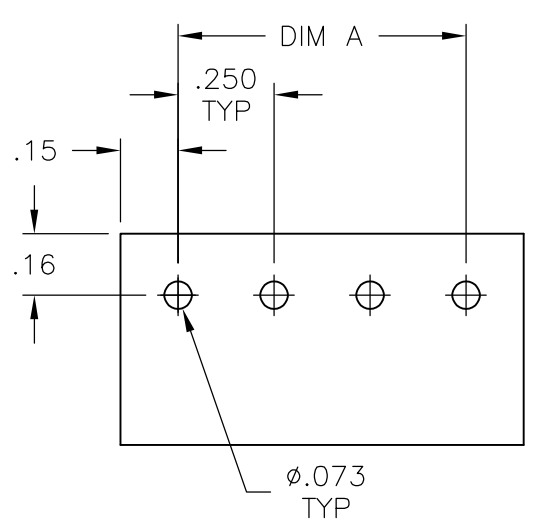
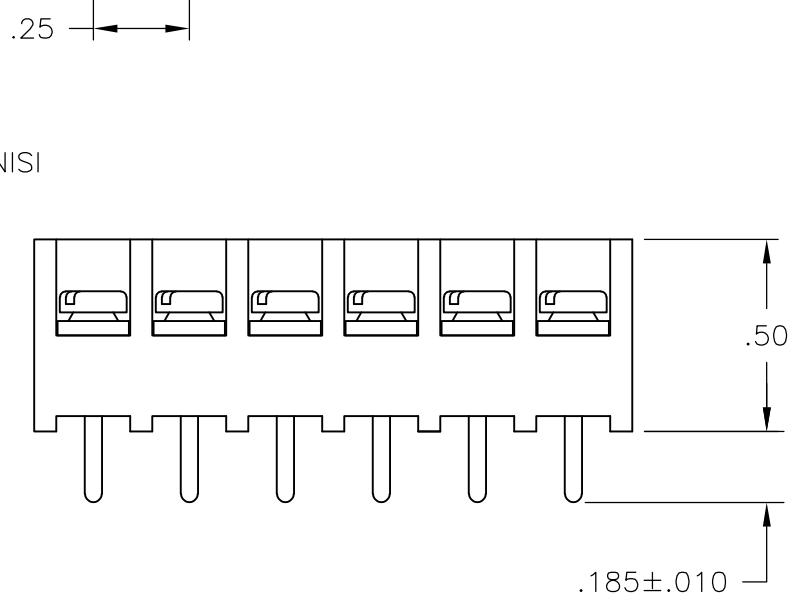
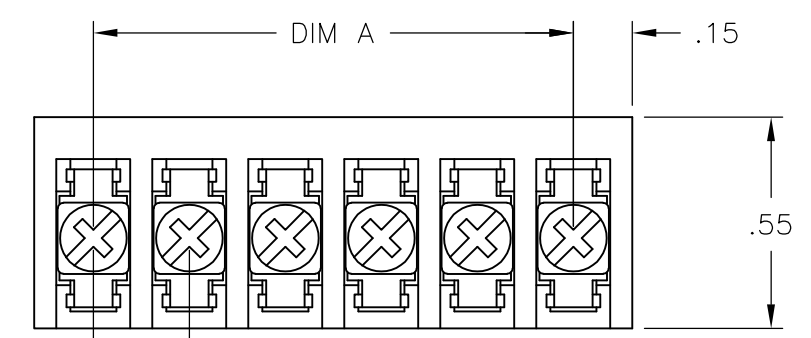

RECOMMENDED PCB LAYOUT

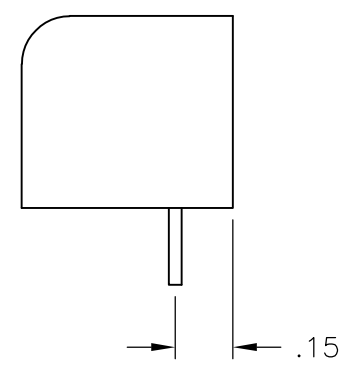
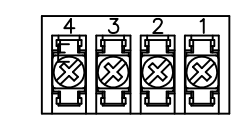
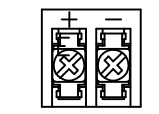
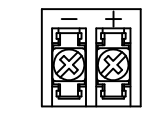

DIM. "A"	NO. OF POS.	CATALOG NUMBER	PART NO.
⑤ .25	2	3PCV-02-006-SPL	796597-3
7.25	30	3PCV-30-006	4-1546119-3
7.00	29	3PCV-29-006	2-1546533-9
6.75	28	3PCV-28-006	2-1546533-8
6.50	27	3PCV-27-006	2-1546533-7
6.25	26	3PCV-26-006	4-1546119-2
6.00	25	3PCV-25-006	2-1546533-5
5.75	24	3PCV-24-006	4-1546119-1
5.50	23	3PCV-23-006	2-1546533-3
5.25	22	3PCV-22-006	3-1546119-9
5.00	21	3PCV-21-006	2-1546533-1
④ 4.75	20	3PCV-20-308	796597-2
4.75	20	3PCV-20-006	796597-1
4.50	19	3PCV-19-006	1-1546533-9
4.25	18	3PCV-18-006	3-1546119-7
4.00	17	3PCV-17-006	3-1546119-6
3.75	16	3PCV-16-006	7-1437646-8
3.50	15	3PCV-15-006	7-1437646-5
3.25	14	3PCV-14-006	7-1437646-3
3.00	13	3PCV-13-006	3-1546119-2
2.75	12	3PCV-12-006	6-1437646-7
2.50	11	3PCV-11-006	2-1546119-9
2.25	10	3PCV-10-006	6-1437646-2
2.00	9	3PCV-09-006	5-1437646-9
1.75	8	3PCV-08-006	5-1437646-7
1.50	7	3PCV-07-006	5-1437646-4
1.25	6	3PCV-06-006	5-1437646-0
1.00	5	3PCV-05-006	4-1437646-5
④ ① .75	4	3PCV-04-006-SPL	2-796988-7
.75	4	3PCV-04-006	4-1437646-2
.50	3	3PCV-03-006	3-1437646-9
④ ① .25	2	3PCV-02-297	2-1546119-2
④ ① .25	2	3PCV-02-296	2-1546119-1
.25	2	3PCV-02-006	3-1437646-3

THIS DRAWING IS A CONTROLLED DOCUMENT.		DWN	S SCHLEGEL	24MAR03	STE TE Connectivity		
DIMENSIONS: INCHES		CHK	S YODER	3/24/03			
TOLERANCES UNLESS OTHERWISE SPECIFIED:		APVD	S YODER	3/24/03	NAME		
0 PLC	± -	PRODUCT SPEC		3PCV-XX-006 ASSEMBLY			
1 PLC	± -	APPLICATION SPEC		SIZE	CAGE CODE	DRAWING NO	RESTRICTED TO
2 PLC	± .02	MATERIAL		A3	00779	C-4-1437646-2	-
3 PLC	± .010	FINISH		CUSTOMER DRAWING			SCALE
4 PLC	± -	MATERIAL		SCALE			NTS
ANGLES	± -	MATERIAL		SHEET			1 OF 1
		MATERIAL		REV			F1

X-ON Electronics

Largest Supplier of Electrical and Electronic Components

Click to view similar products for [Barrier Terminal Blocks](#) category:

Click to view products by [TE Connectivity](#) manufacturer:

Other Similar products are found below :

[CR151D20104](#) [670A-RZ-15-KT20](#) [6C1N03](#) [6PCR-02](#) [6PCR-02-008](#) [6PCR-05-008](#) [6PCR-08-008](#) [6PCR-09-008](#) [6PCR-13-006](#) [6PCR-15-006](#) [6PCR-21-006](#) [6PCV-06-008](#) [6PCV-06-716](#) [6PCV-09-001](#) [6PCV-10-009](#) [6PCV-15-008](#) [6PCV-17-1206](#) [6PCV-20-323](#) [6PCV-20-720](#) [6PCV-30-006](#) [6STR-06-006](#) [6STR-08-006](#) [6STR-12-008](#) [6STR-13-006](#) [6STR-14-008](#) [6STR-16-008](#) [6STR-17-008](#) [6STR-21-008](#) [6STR-25-008](#) [6STR-27-008](#) [6STV-03-006](#) [6STV-03-008](#) [6STV-04-006](#) [6STV-09-006](#) [6STV-10-006](#) [6WWR-03-693](#) [6WWV-12-008](#) [72212603](#) [72504-C-50](#) [72506-C](#) [72507-C-50](#) [73203](#) [75505-C](#) [75505-C-50](#) [75510-C](#) [77010-50](#) [7C1N08](#) [812-GP-3/4ST-09](#) [8-1437402-5](#) [8-1437402-7](#)