

Sockets & Accessories, KUP Relays

- Sockets for 1 - 3 pole relays with .187" (4/75mm) quick connects or 4 pole relays with .110" (2.79mm) quick connects
- Solder, PCB or screw terminal sockets
- Hold down springs
- Various mounting options



Approvals

UL E59244, CSA LR15734

Technical data of approved types on request.

Technical Data

Socket contact material	Spring brass, tin plated
Socket body material	
Solder, PCB and QC terminal models	Nylon
Screw terminal models - 3 pole	Glass-filled polyester
Screw terminal model - 4 pole	Combination (PCB assembly)
Maximum current	
Screw terminal model - 4 pole	10A
All other models	15A

Ordering Code for Sockets



Product Code	Poles	Terminal type	Mounting	Rating	Part number
27E043	3	solder	hard mount	15A	1393143-1
27E067		.187 in (4.75) quick connect			1393143-2
27E046		PCB .144 in (3.66) long			1419106-4
27E305		PCB .184 in (4.67) long			3-1393143-2
27E419	4	PCB .156 in (3.96) long			4-1393143-0
27E396	3	.187 in (4.75) quick connect	snap-in		3-1393143-8
27E121		screw	panel/rail		1393143-5
27E893			DIN-rail		2-1419106-5
27E867	4		panel-rail	10A	2-1419106-2

All accessories must be ordered separately.

Dimensions

Hard Mount Sockets For Relays Through 3 Poles

Sockets with .187" (4.75mm) quick connect, solder or printed circuit terminals are available for KUEP, KUGP, KUIP, KUL, KUMP and KUP relays, through 3 poles, with .187" (4.75mm) quick connect terminals. Also used with CL/CU time delay relays. 27E043—with solder eyelet terminals. 27E067—with .187" (4.75mm) quick connect terminals.

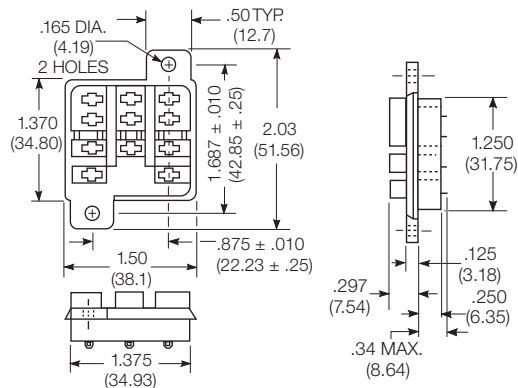

Recommended chassis cutout for solder terminal socket

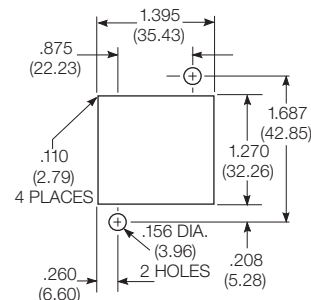

PC board layout for 3 pole PCB terminal socket

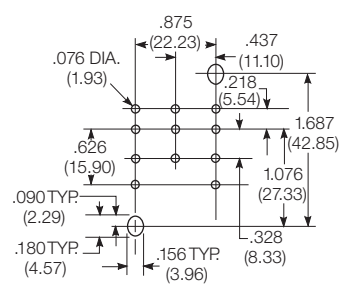

Recommended Chassis Thickness
.031 (.79) to .062 (1.57)

Sockets & Accessories, KUP Relays (Continued)

Dimensions

Snap-in Socket For Relays Through 3 Poles

Socket with with .187" (4.75mm) quick connect terminals is available for KUJEP, KUGP, KUIP, KUL, KUMP and KUP relays, through 3 poles, with .187" (4.75mm) quick connect terminals. Also used with CL/CU time delay relays. 27E396—with .187" (4.75mm) quick connect terminals

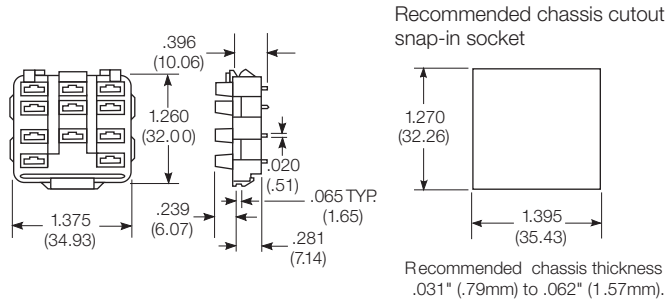

Hard mount sockets for relays with 4 poles

Socket with printed circuit terminals is available for KUP relays, with 4 poles, with .110" (2.79mm) quick connect terminals. 27E043—with solder eyelet terminals. 27E419—with printed circuit terminals.

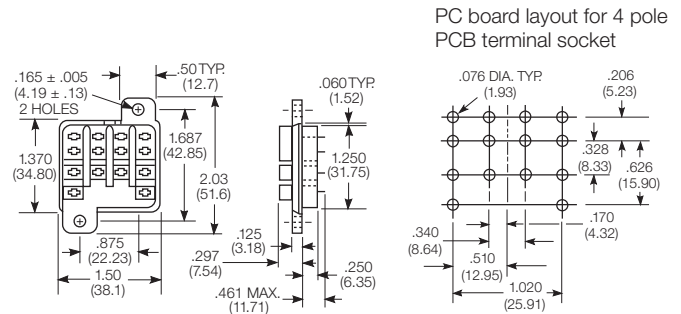

Caution: Printed circuit sockets are manufactured with "floating" (Loose) terminals. This permits them to align with holes in the circuit board and with the relay terminals. During the mounting and soldering of the socket, vertical float should be eliminated and the terminals seated on the board. (This may be accomplished by inserting a dummy relay in the socket.) Failure to eliminate float may cause fracture of the solder joint or separation of the copper conductor from the printed circuit board when a relay is inserted in the socket after soldering.

Screw terminal socket for relays through 3 poles 27E121

Offers screw termination for KUJEP, KUGP, KUIP, KUL, KUMP and KUP relays, through 3 poles, with .187" (4.75mm) quick connect terminals. Also used with CL/CU time delay relays. This socket stacks on 1.700" (43.18mm) centers. When surface mounting, two #6-32 screws of suitable length are required. When track mounting, two 24A071 retainer clips (not shown) are required.

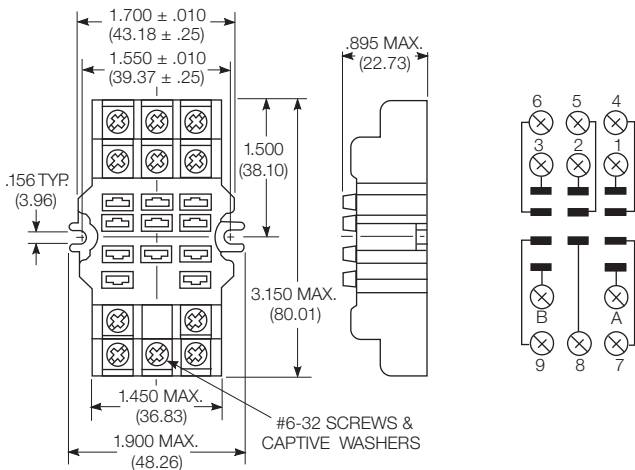

Screw terminal, DIN rail, snap-mount socket 27E893

Offers screw termination for KUJEP, KUGP, KUIP, KUL, KUMP and KUP relays, through 3 poles, with .187" (4.75mm) quick connect terminals. Also used with CL/CU time delay relays. This socket is constructed with a spring-loaded latch which allows it to be quickly snapped onto or removed from a DIN or "top hat" style mounting track. No special tools or extra hardware is required for installation.

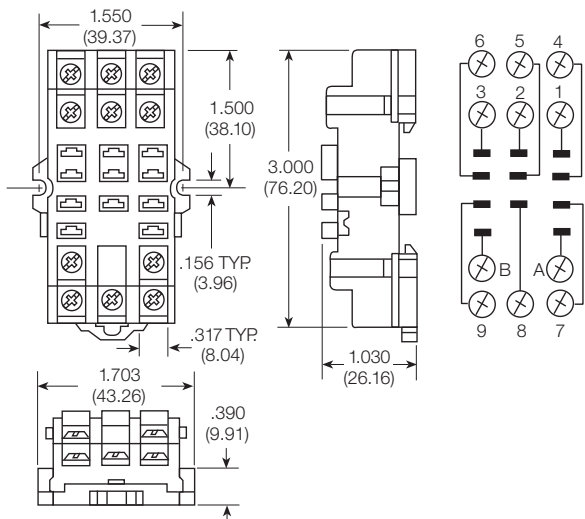

Sockets & Accessories, KUP Relays (Continued)

Dimensions and terminal location

Screw terminal socket for relays with 4 poles 27E867
Socket with screw terminals is available for KUP relays, with 4 poles, with .110" (2.79mm) quick connect terminals.

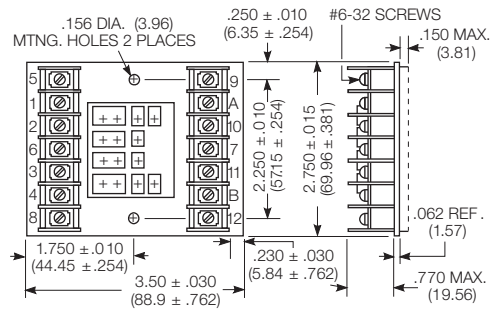

Suggested track mounting

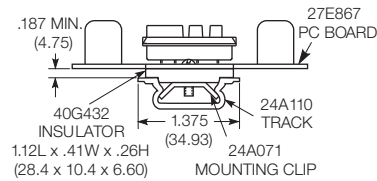

Suggested chassis mounting

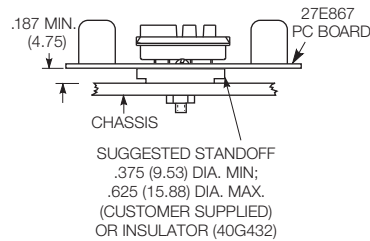

Ordering Code for Accessories

Product Code	Description	Part number
20C254	Snap-in relay hold down spring for use with all KUP sockets listed on these pages except 27E121 and 27E893.	3-1393159-9
20C228	Relay hold down spring for use with hard mount KUP sockets. Is held in place by socket mounting hardware.	1419111-3
20C318	Relay hold down spring for use with 27E893 DIN rail screw terminal socket	4-1393159-8
20C314	Relay hold down clip for use with 27E121 screw terminal socket. 2 required per socket.	4-1393159-6
24A110	Mounting track	1419111-6
24A071	Steel mounting clip with #6-32 screw - use with 27E166 on 24A110 track	1419111-5
24A072	Plastic twist mounting clip - use with 27E166 on 24A110 track	5-1393159-4
40G432	Plastic insulator - use with 24A071 to make end clip for 24A110 track	9-1393159-5

All accessories must be ordered separately.

Dimensions

24A110 DIN rail style mounting track

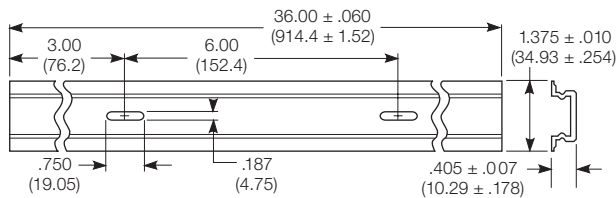

24A110 mounting track is designed to accept snap-mount sockets, as well as other P&B screw terminal sockets. Track is made of lightweight, sturdy extruded aluminum and is shipped in three-foot (914cm) lengths with mounting holes on six-inch (152mm) centers. Track can be cut to shorter lengths or used end-to-end.

Track and mounting accessories

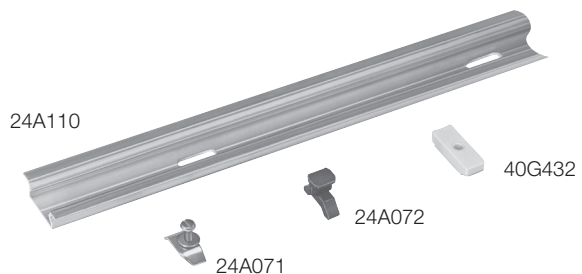

X-ON Electronics

Largest Supplier of Electrical and Electronic Components

Click to view similar products for [Relay Sockets & Hardware](#) category:

Click to view products by [TE Connectivity](#) manufacturer:

Other Similar products are found below :

[00111976502](#) [7-1393143-3](#) [7-1616347-8](#) [7-1616350-5](#) [8-1616360-6](#) [9-1616339-5](#) [9-1616358-1](#) [9-1616359-7](#) [9-1616360-2](#) [PLC-10](#) [PT08QN](#)
[PT 1/8 D = 3.2](#) [12082001](#) [R99-11 FOR MY\(NAMEPLATE\)](#) [RES100K](#) [13909001](#) [1393824-3](#) [13900001](#) [1415526-1](#) [1419106-5](#) [1423683-1](#)
[1415037-1](#) [14486001](#) [1423685-1](#) [MS-24H](#) [16-1328](#) [MT78N60](#) [17540001](#) [20C419](#) [2-1393102-4](#) [2-1419106-9](#) [2-1608090-1](#) [P70A](#)
[AC100/110](#) [PB-4H](#) [21B212](#) [RSE120027](#) [9-1616337-0](#) [9-1616337-6](#) [9-1616358-3](#) [27E1038](#) [27E448](#) [S82Y-RN](#) [2944533](#) [LMC-1](#) [16-1340](#)
[16154040](#) [1618065-7](#) [9P40X1](#) [17891020](#) [17892040](#)