

**Miniature Power PCB RYII & RYII Reflow Solderable**

- 1 pole 8A, 1 form C (CO) or 1 form A (NO) or 1 form B (NC) contact
- Low component height 12.3mm
- 5kV/8mm coil-contact
- Reinforced insulation (protection class II)
- Pinnings: 3.2mm and 5mm
- Reflow-solderable version
- Especially suitable for resistive and inductive loads on form A (NO) and form B (NC) contacts
- Plastic materials according to IEC 60335-1 (domestic appliances)

Typical applications  
heating control, interface technology, domestic appliances, timers, temperature control



F0142-E



**Approvals**

VDE Cert. No. 40009639, UL E214025  
Technical data of approved types on request

**Contact Data**

Contact arrangement	1 form C (CO) or 1 form A (NO) or 1 form B (NC)
Rated voltage	250VAC
Max. switching voltage	400VAC
Rated current	8A
Breaking capacity max.	2000VA
Contact material	AgNi0.15, AgSnO <sub>2</sub>
Frequency of operation, with/without load	6/1200min <sup>-1</sup>
Operate/release time max.	9/5ms
Bounce time max., form A/form B	6/10ms

**Contact ratings**

Type	Contact	Load	Cycles
<b>IEC61810</b>			
RY531	A (NO)	8A, 250VAC, 70°C	100x10 <sup>3</sup>
RY211	A (NO)	8A, 250VAC, 70°C	75x10 <sup>3</sup>
RY211	B (NC)	8A, 250VAC, 70°C	50x10 <sup>3</sup>
<b>UL508</b>			
RY211	A/B (NO/NC)	10A, 250VAC, general purpose, 70°C	30x10 <sup>3</sup>
RY211	A (NO)	1/2hp, 240VAC, 85°C	30x10 <sup>3</sup>
RY211	A/B (NO/NC)	B300, 70°C	6x10 <sup>3</sup>
<b>EN60730-1</b>			
RY211	A/B (NO/NC)	6(4)A, 250VAC, 85°C	100x10 <sup>3</sup>
RY211	A (NO)	8(4)A, 250VAC, 75°C	100x10 <sup>3</sup>
Mechanical endurance, DC coil		30x10 <sup>6</sup> operations	

**Coil Data**

Coil voltage range	5 to 60VDC
Operative range, IEC 61810	2

**Coil versions, DC coil**

Coil code	Rated voltage VDC	Operate voltage VDC	Release voltage VDC	Coil resistance Ω±10%	Rated power mW
005	5	3.5	0.5	112	223
006	6	4.2	0.6	162	222
009	9	6.3	0.9	320	253
012	12	8.4	1.2	627	230
024	24	16.8	2.4	2350	245
048	48	33.6	4.8	9391	245
060	60	42.0	6.0	14000	257

All figures are given for coil without pre-energization, at ambient temperature +23°C  
Other coil voltages on request

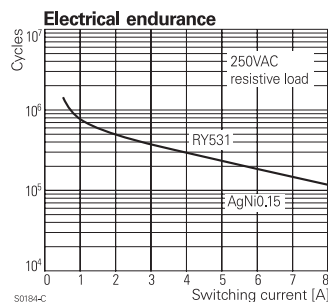
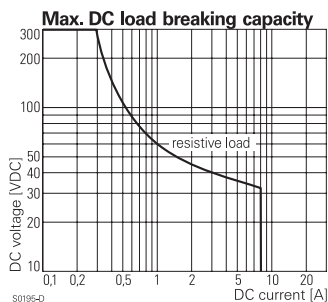
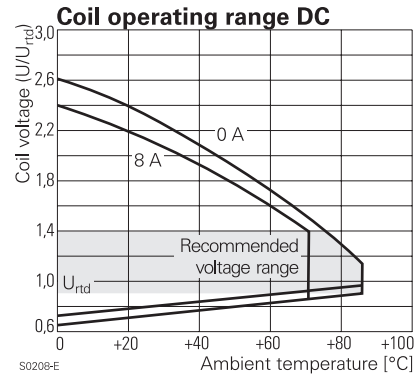

**Insulation Data**

Initial dielectric strength	
between open contacts	1000V <sub>rms</sub>
between contact and coil	5000V <sub>rms</sub>
Clearance/creepage	
between contact and coil	≥8/8mm
Material group of insulation parts	IIIa
Tracking index of relay base	PTI250
reflow-solderable version	PTI175

**Miniature Power PCB RYII & RYII Reflow Solderable** (Continued)

**Other Data**

Material compliance: EU RoHS/ELV, China RoHS, REACH, Halogen content refer to the Product Compliance Support Center at [www.te.com/customersupport/rohssupportcenter](http://www.te.com/customersupport/rohssupportcenter)

Ambient temperature	-40 to +70°C +85°C at 6A
Category of environmental protection IEC 61810	RTII - flux proof RTIII - wash tight <sup>1)</sup>
Vibration resistance (functional), form A (NO)/form B (NC)	20/5g
Shock resistance (functional) form A (NO)/form B (NC)	20/5g
Shock resistance (destructive)	100g
Terminal type	PCB-THT, PCB-THR
Weight	8g
Resistance to soldering heat THT IEC 60068-2-20	RTII : 270°C/10s RTIII : 260°C/5s
Resistance to soldering heat THR IEC 60068-2-58	250°C, no infrared heating allowed
Packaging/unit standard version	tube/20 pcs., box/500 pcs.
reflow version	reel/280 pcs. box/1120 pcs. (4 reels)

<sup>1)</sup> not available as reflow-solderable version

**Accessories**

For details see datasheet [Accessories Miniature PCB Relay RY](#)

**PCB layout / terminal assignment**

Bottom view on solder pins

1 form C (CO) contact, 3.2mm

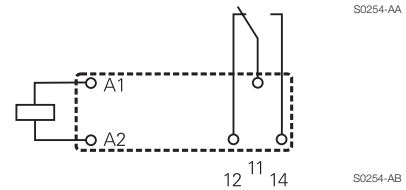
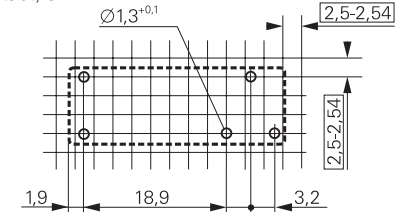

1 form A (NO), 1 form B (NC) contact 5mm

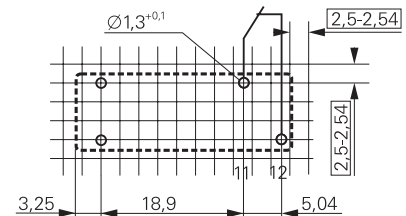
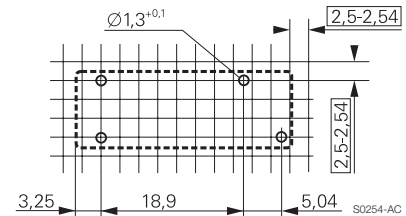

**Dimensions**

Pinning 3.2mm

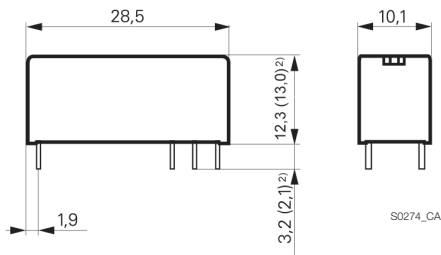

Pinning 5mm



<sup>2)</sup> Values in brackets are valid for reflow-solderable version

**Miniature Power PCB RYII & RYII Reflow Solderable** (Continued)

**Soldering profile for reflow-solderable version**

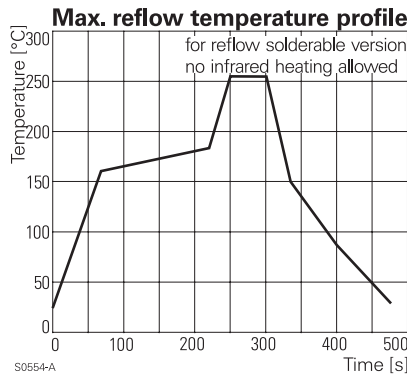

**Tape dimensions**

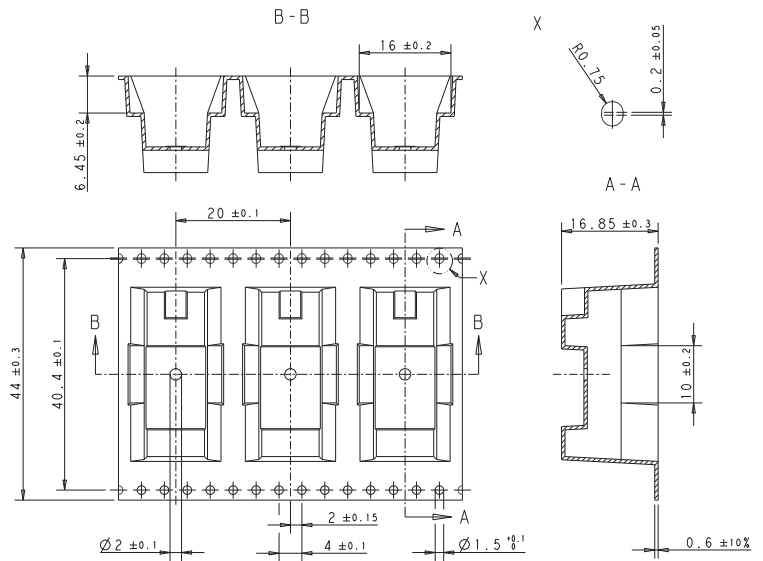

**Reel dimensions**

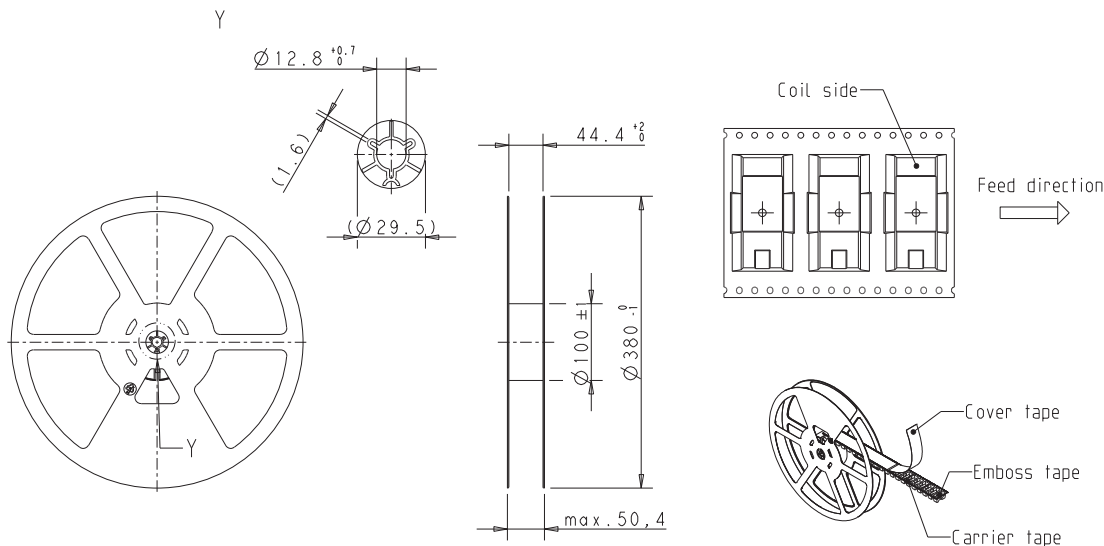

**Product code structure**

Typical product code **RY 6 1 1 012**

**Type**

**RY** Miniature Power PCB RYII & RYII reflow solderable

**Version**

- 2** pinning 3.2mm, flux proof
- 5** pinning 5mm, flux proof
- 6** pinning 3.2mm, wash tight <sup>2)</sup>
- A** pinning 5mm, wash tight <sup>2)</sup>

**Contact arrangement**

- 1** 1 form C (1 CO), pinning 3.2mm
- 3** 1 form A (1 NO), pinning 5mm
- 5** 1 form B (1 NC), pinning 5mm

**Contact material**

- 1** AgNi 0.15
- 3** AgSnO<sub>2</sub>
- 2** AgNi 0.15 gold plated

**Coil**

Coil code: please refer to coil versions table

**Version**

- Blank** Standard version
- R** reflow-solderable

<sup>2)</sup> not available as reflow-solderable version

**Miniature Power PCB RYII & RYII Reflow Solderable** (Continued)

Product code	Version	Contacts	Contact material	Coil	Part number
RY211005	Pinning 3.2 mm flux proof	1 form C, 1 CO contact	AgNi 0.15	5VDC	4-1393224-2
RY211012				12VDC	4-1393224-6
RY211024				24VDC	4-1393224-9
RY211048				48VDC	5-1393224-1
RY212005			AgNi 0.15 gold plated	5VDC	5-1393224-2
RY212012				12VDC	5-1393224-5
RY212024				24VDC	5-1393224-8
RY212048				48VDC	5-1393224-9
RY213005			AgSnO <sub>2</sub>	5VDC	6-1393224-0
RY213012				12VDC	6-1393224-1
RY213024				24VDC	6-1393224-2
RY213048				48VDC	6-1393224-3
RY531005	Pinning 5 mm flux proof	1 form A, 1 NO contact	AgNi 0.15	5VDC	7-1393224-6
RY531012				12VDC	7-1393224-9
RY531024				24VDC	8-1393224-2
RY531048				48VDC	8-1393224-3
RY532012			AgNi 0.15 gold plated	12VDC	8-1393224-4
RY532024				24VDC	8-1393224-5
RY533012			AgSnO <sub>2</sub>	12VDC	8-1393224-8
RY533024				24VDC	8-1393224-9
RY533048				48VDC	9-1393224-0
RY611005	Pinning 3.2 mm wash tight	1 form C, 1 CO contact	AgNi 0.15	5VDC	1-1393225-7
RY611012				12VDC	1-1393225-9
RY611024				24VDC	2-1393225-1
RY611048				48VDC	2-1393225-2
RY612005			AgNi 0.15 gold plated	5VDC	2-1393225-3
RY612012				12VDC	2-1393225-6
RY612024				24VDC	2-1393225-9
RY612048				48VDC	3-1393225-0
RY613005			AgSnO <sub>2</sub>	5VDC	5-1419136-2
RY613012				12VDC	3-1393225-1
RY613024				24VDC	3-1393225-3
RY613048				48VDC	3-1393225-4
RY631024		1 form A,	AgNi 0.15	24VDC	4-1415400-1
RYA31005	Pinning 5 mm wash tight	1 NO contact		5VDC	1393224-7
RYA31012			12VDC	1393224-9	
RYA31024				24VDC	1-1393224-2
RYA31048				48VDC	1-1393224-3
RYA32005			AgNi 0.15 gold plated	5VDC	1-1393224-4
RYA32012				12VDC	1-1393224-6
RYA32024				24VDC	1-1393224-8
RYA33005			AgSnO <sub>2</sub>	5VDC	1-1393224-9
RYA33024				24VDC	2-1393224-1

Product code	Version	Contacts	Contact material	Coil	Part number
RY211005R	pinning 3.2mm flux proof reflow solderable	1 form C, 1 CO contact	AgNi 0.15	5VDC	1-1956170-2
RY211012R				12VDC	1-1956170-6
RY211024R				24VDC	1956164-1
RY531005R	pinning 5.0mm flux proof	1 form A, 1 NO contact		5VDC	1-1956171-1
RY531012R				12VDC	1-1956171-4
RY531024R	reflow solderable			24VDC	1-1956171-7

## X-ON Electronics

Largest Supplier of Electrical and Electronic Components

*Click to view similar products for [General Purpose Relays](#) category:*

*Click to view products by [TE Connectivity](#) manufacturer:*

Other Similar products are found below :

[APF30318](#) [JVN1AF-4.5V-F](#) [PCN-105D3MHZ](#) [5JO-10000S-SIL](#) [5JO-1000CD-SIL](#) [5JO-400CD-SIL](#) [LY2S-AC220/240](#) [LYQ20DC12](#)  
[6031007G](#) [6131406HQ](#) [6-1393099-8](#) [6-1393122-4](#) [6-1393123-2](#) [6-1393767-1](#) [6-1393843-7](#) [6-1415012-1](#) [6-1419102-2](#) [6-1423698-4](#) [6-](#)  
[1608051-6](#) [6-1608067-0](#) [6-1616170-6](#) [6-1616248-2](#) [6-1616282-3](#) [6-1616348-2](#) [6-1616350-1](#) [6-1616350-8](#) [6-1616358-7](#) [6-1616359-9](#) [6-](#)  
[1616360-9](#) [6-1616931-6](#) [6-1617039-1](#) [6-1617052-1](#) [6-1617090-2](#) [6-1617090-5](#) [6-1617347-5](#) [6-1617353-3](#) [6-1617801-8](#) [6-1618107-9](#) [6-](#)  
[1618248-4](#) [M83536/1-027M](#) [CX-4014](#) [MAHC-5494](#) [MAVCD-5419-6](#) [703XCX-120A](#) [7-1393100-5](#) [7-1393111-7](#) [7-1393767-8](#) [7-1414968-8](#)  
[7-1419130-3](#) [7-1608047-2](#)