

**Cradle W Relay V23005**

- Highly reliable
- Great variety of contact arrangements and materials to meet specific applications
- Contacts for signal loads and currents up to 5A
- For AC operating only
- Neutral, monostable



Typical applications  
Operation of the coil with alternating voltage, machine controls

**Contact Data**

Product code block 3	B104/B110	B604/B610	C104/C110	C404/C410	F104 to F107
Contact arrangement	max. 4 form C (4CO) contacts, 2 form B (2 NC) contacts or 2 form A (2 NO) contacts (see product code table)				
Max. switching voltage	150VDC 125VAC	36VDC 30VAC	150VDC 125VAC	36VDC 30VAC	250VDC 250VAC
Rated current	2A	0.2A	2A	0.2A	5A
Limiting continuous current at max. ambient temperature	2A	2A	2A	2A	5A
Breaking capacity see DC load breaking capacity curve below	35 to 70W 50VA	5W, 5VA	35 to 70W 50VA	5W, 5VA	50 to 140W 500VA
Contact material	silver, gold-flashed	gold F	silver, gold-flashed	gold F	silver, gold-flashed
Contact style	single contact	single contact	bifurcated contacts	bifurcated contacts	single contact
Frequency of operation, without load, max.	20 ops./s	20 ops./s	20 ops./s	20 ops./s	20 ops./s
Mechanical endurance	app. 10 <sup>7</sup> ops.	app. 10 <sup>7</sup> ops.	app. 10 <sup>7</sup> ops.	app. 10 <sup>7</sup> ops.	app. 10 <sup>8</sup> ops.

**Max. DC breaking capacity, contact sets B1xx, C1xx**

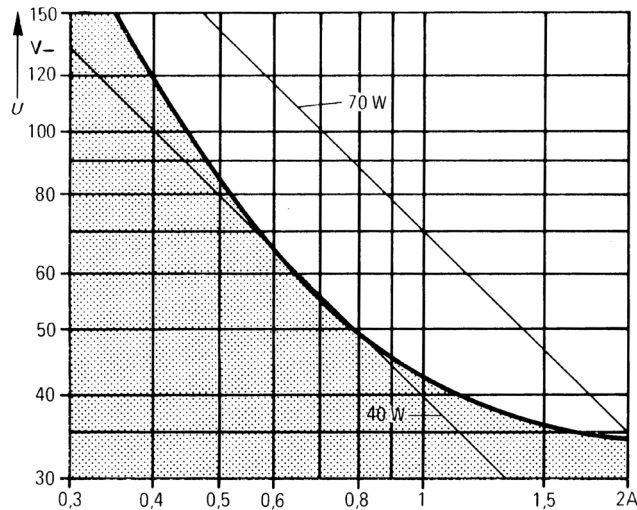

**Max. DC breaking capacity, contact sets F1xx**

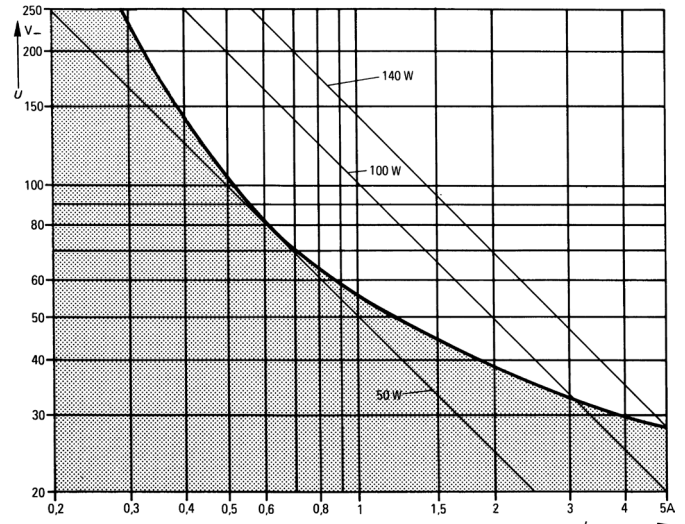

**Cradle W Relay V23005** (Continued)

**Coil Data**

Magnetic system	neutral
Coil voltage range	6 to 220 VAC (50Hz/ 60Hz)
Operative range, IEC 61810	1
Operating voltage	80% of rated coil voltage
Rated coil power, typ.	1.15VA
Max. coil temperature	100°C
Thermal resistance	35K/W

**Coil versions, AC coil**

Coil code	Rated voltage VAC	Operate voltage VAC	Coil resistance $\Omega \pm 15\%$	Rated coil power VA <sup>1)</sup>
015	6	4.8	8	1.15
017	12	9.6	40	1.15
021	18	14.4	108	1.15
010	24	19.2	170	1.15
009	42	33.6	550	1.15
019	48	38.4	620	1.15
008	60	48	1000	1.15
007	110	88	3200	1.15
004	220	176	14000	1.15

1) Typical value.

All figures are given for coil without pre-energization, at ambient temperature +23°C.

**Insulation Data** B1xx, B6xx, C1xx, C4xx F1xx

Initial dielectric strength between coil and frame	500VAC <sub>rms</sub> at rated voltages $\leq 60V$ 2000VAC <sub>rms</sub> at rated voltages $> 60V$	
between contact and contact	500VAC <sub>rms</sub>	1000VAC <sub>rms</sub>
between contact and frame	500VAC <sub>rms</sub>	1000VAC <sub>rms</sub>
Initial insulation resistance, at 500 VDC	$> 10^6 \Omega$	

**Other Data**

Material compliance: EU RoHS/ELV, China RoHS, REACH, Halogen content refer to the Product Compliance Support Center at [www.te.com/customer-support/rohssupportcenter](http://www.te.com/customer-support/rohssupportcenter)

Ambient temperature	-40 to + 70°C
Category of environmental protection IEC 61810	RT I - dust protected
Degree of protection, IEC 60529	IP 40
Terminal type	solder terminals, suitable for plug-in-and socket connection plus screw fixing

Weight	
V23003-A0xxx Size I	approx. 35g
V23003-B0xxx Size II	approx. 40g
Washing	not recommended
Ultrasonic cleaning	not recommended
Packaging unit	5 pcs.

**Accessories**

For details see datasheet Cradle Relay, Accessories and Mounting

**Terminal assignment**

**Size I**

2 form C (2 CO)  
V23005-xxxx-Bx04  
V23005-xxxx-Cx04

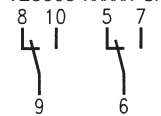

2 form A (2 NO)  
V23005-xxxx-F105



2 form B (2 NC)  
V23005-xxxx-F107

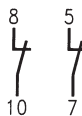

1 form A + 1 form B  
(1 NO + 1 NC)  
V231005-xxxx-F106

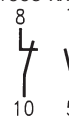

**Size II**

4 form C (4 CO)  
V231005-xxxx-Bx10  
V231005-xxxx-Cx10

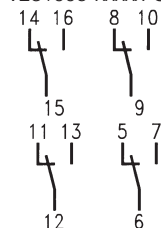

2 form C (2 CO)  
V231005-xxxx-F104

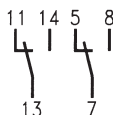

Coil terminals: 1, 4

**Cradle W Relay V23005** (Continued)

Dimensions

V23005-A0xx, size I type

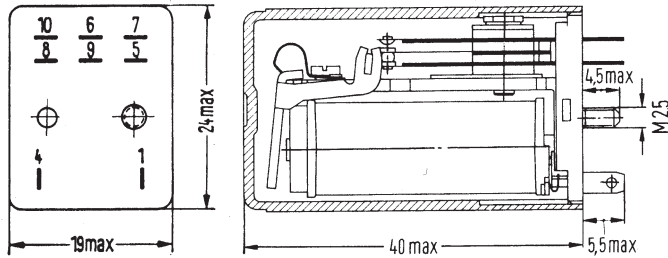

V23005-B0xx, size II type

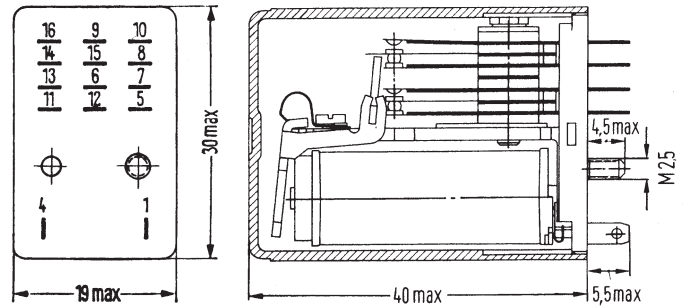

Product code structure

Typical product code **V23005 -B0 004 -F104**

<b>Type</b>	V23005 Cradle W Relay		
<b>Size</b>	A0 Size I, dust protected B0 Size II, dust protected		
<b>Coils</b>	Coil code: please refer to coil versions table		
<b>Contact style</b>	B1 Single contacts C1 Bifurcated contacts	B6 Single contacts C4 Bifurcated contacts	F1 Single contacts
<b>Contact arrangement</b>	04 2 form C, 2 CO 10 4 form C, 4 CO	05 2 form A, 1 NO 12 6 form A, 6 NO	06 1 form A+ 1 form B, 1 NO+ 1 NC

Other types on request

**Cradle W Relay V23005** (Continued)

Product code	Version	Coil	Arrangement	Contacts	Enclosure	PartNumber
<b>V23005-AXXXX, standard, size I</b>						
V23005-A0017-B104	Standard, size I	12VAC	2 form C (2 CO)	Single	Dust protected	1-1393816-8
V23005-A0021-C104	Standard, size I	18VAC	2 form C (2 CO)	Bifurcated	Dust protected	2-1393816-0
V23005-A0010-B104	Standard, size I	24VAC	2 form C (2 CO)	Single	Dust protected	1-1393816-7
V23005-A0009-B104	Standard, size I	42VAC	2 form C (2 CO)	Single	Dust protected	1-1393816-5
V23005-A0019-B104	Standard, size I	48VAC	2 form C (2 CO)	Single	Dust protected	1-1393816-9
V23005-A0008-B104	Standard, size I	60VAC	2 form C (2 CO)	Single	Dust protected	1-1393816-4
V23005-A0007-B104	Standard, size I	110VAC	2 form C (2 CO)	Single	Dust protected	1393816-8
V23005-A0007-B604	Standard, size I	110VAC	2 form C (2 CO)	Single	Dust protected	1-1393816-0
V23005-A0007-C104	Standard, size I	110VAC	2 form C (2 CO)	Bifurcated	Dust protected	1-1393816-1
V23005-A0004-B104	Standard, size I	220VAC	2 form C (2 CO)	Single	Dust protected	1393816-1
V23005-A0004-B604	Standard, size I	220VAC	2 form C (2 CO)	Single	Dust protected	1393816-3
V23005-A0004-C104	Standard, size I	220VAC	2 form C (2 CO)	Bifurcated	Dust protected	1393816-4
<b>V23005-AXXXX, 5A, size I</b>						
V23005-A0009-F106	5A, size I	42VAC	1 A + 1 B (1 NO+1 NO)	Single	Dust protected	1-1393816-6
V23005-A0007-F105	5A, size I	110VAC	2 form A (2 NO)	Single	Dust protected	1-1393816-2
V23005-A0007-F106	5A, size I	110VAC	1 A + 1 B (1 NO+1 NO)	Single	Dust protected	1-1393816-3
V23005-A0004-F105	5A, size I	220VAC	2 form A (2 NO)	Single	Dust protected	1393816-6
V23005-A0004-F106	5A, size I	220VAC	1 A + 1 B (1 NO+1 NO)	Single	Dust protected	1393816-7
<b>V23005-BXXXX, standard, size II</b>						
V23005-B0017-B110	Standard, size II	12VAC	4 form C (4 CO)	Single	Dust protected	4-1393816-5
V23005-B0010-B110	Standard, size II	24VAC	4 form C (4 CO)	Single	Dust protected	4-1393816-0
V23005-B0010-C110	Standard, size II	24VAC	4 form C (4 CO)	Bifurcated	Dust protected	4-1393816-1
<b>V23005-B0010-C410</b>						
V23005-B0009-B110	Standard, size II	42VAC	4 form C (4 CO)	Single	Dust protected	3-1393816-7
V23005-B0009-C110	Standard, size II	42VAC	4 form C (4 CO)	Bifurcated	Dust protected	3-1393816-8
V23005-B0008-B110	Standard, size II	60VAC	4 form C (4 CO)	Single	Dust protected	3-1393816-5
V23005-B0007-B110	Standard, size II	110VAC	4 form C (4 CO)	Single	Dust protected	3-1393816-0
V23005-B0007-B610	Standard, size II	110VAC	4 form C (4 CO)	Single	Dust protected	3-1393816-1
V23005-B0007-C110	Standard, size II	110VAC	4 form C (4 CO)	Bifurcated	Dust protected	3-1393816-2
V23005-B0007-C410	Standard, size II	110VAC	4 form C (4 CO)	Bifurcated	Dust protected	3-1393816-3
V23005-B0004-B110	Standard, size II	220VAC	4 form C (4 CO)	Single	Dust protected	2-1393816-2
V23005-B0004-B610	Standard, size II	220VAC	4 form C (4 CO)	Single	Dust protected	2-1393816-4
V23005-B0004-C110	Standard, size II	220VAC	4 form C (4 CO)	Bifurcated	Dust protected	2-1393816-5
V23005-B0004-C410	Standard, size II	220VAC	4 form C (4 CO)	Bifurcated	Dust protected	2-1393816-6
<b>V23005-BXXXX, 5A, size II</b>						
V23005-B0015-F104	5A, size II	6VAC	2 form C (2 CO)	Single	Dust protected	4-1393816-4
V23005-B0017-F104	5A, size II	12VAC	2 form C (2 CO)	Single	Dust protected	4-1393816-6
V23005-B0010-F104	5A, size II	24VAC	2 form C (2 CO)	Single	Dust protected	4-1393816-3
V23005-B0009-F104	5A, size II	42VAC	2 form C (2 CO)	Single	Dust protected	3-1393816-9
V23005-B0008-F104	5A, size II	60VAC	2 form C (2 CO)	Single	Dust protected	3-1393816-6
V23005-B0007-F104	5A, size II	110VAC	2 form C (2 CO)	Single	Dust protected	3-1393816-4
V23005-B0004-F104	5A, size II	220VAC	2 form C (2 CO)	Single	Dust protected	2-1393816-8

## X-ON Electronics

Largest Supplier of Electrical and Electronic Components

*Click to view similar products for [Low Signal Relays - PCB category](#):*

*Click to view products by [TE Connectivity manufacturer](#):*

Other Similar products are found below :

[LZN4-US-DC12](#) [LZNQ4-US-DC24](#) [LZNQ4-US-DC48](#) [6-1393813-4](#) [6-1462039-0](#) [6-1617347-5](#) [6-1617353-3](#) [6-1617529-6](#) [M39016/20-054M](#) [M39016/27-030M](#) [67RPCX-3](#) [MAHC-5494](#) [D3493L](#) [7-1393809-0](#) [7-1393813-3](#) [741B8](#) [7556072001](#) [MF-11AM-24](#) [MF1201N12](#) [MF-17A-24](#) [FBR244D012/02CP](#) [FBR244D024/02CS](#) [80.010.4522.1](#) [FL-4036](#) [FLH-11D-6](#) [831A7](#) [MMS124](#) [FTR-B4GA006Z](#) [FW1102S06](#) [FW1201S39](#) [FW1210S02](#) [FW1521S01](#) [FW5A1201S14](#) [9-1393813-6](#) [9-1617582-5](#) [G6AK-2-H-DC5](#) [G6E-184P-ST-US-DC48](#) [G6G234CDC24](#) [A07A939BZ1-0388](#) [A150-0005](#) [PZ-2A2420](#) [HB1-DC6V](#) [HB1-DC9V](#) [R10-14A10-240](#) [R10-14D10-12](#) [R10-5A10-120F](#) [R10-E1L8-S200](#) [R10-E2468-1](#) [R10-E4Z2-V700](#) [R10-T1L2N-115V](#)