

LOC	DIST	REVISIONS			
P	LTR	DESCRIPTION	DATE	DWN	APVD
DW		J	REVISED PER ECO-19-018195	20OCT2020	D.S H.L

- NOTE:
- MATERIAL:
 HOUSING: PA9T, UL94 V-0, COLOR: (SEE TABLE).
 CONTACTS: BRASS.
 CAP: LCP UL94 V-0, COLOR :BLACK.
 - FINISH:
 CONTACTS: 3.05um [120u"] MIN. MATTE-TIN.
 1.27um [50u"] MIN. NICKEL UNDERPLATED ALL OVER.
 - WAVE SOLDER CAPABLE TO 265°C PER TEST SPEC.
 109-202, CONDITION B.
 - NO TE LOGO AND DATE CODE ON THE PRODUCT WITH 4 POS.
 - THE KEY IDENTIFIED WAS SHOWN ON PAGE 5.

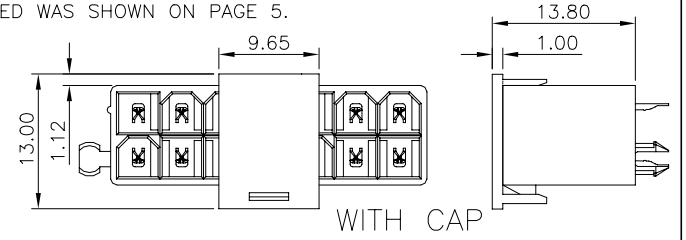
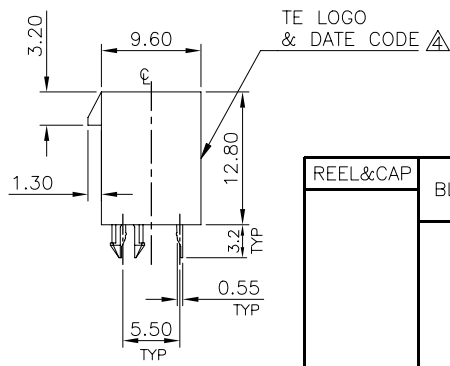
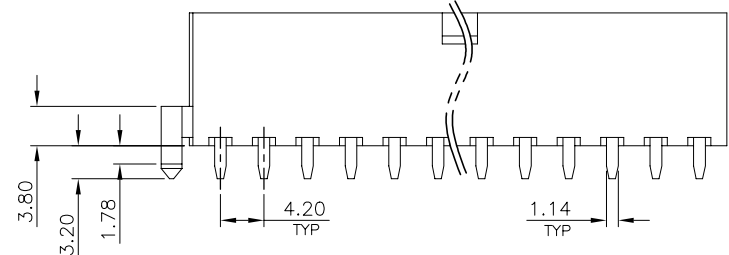
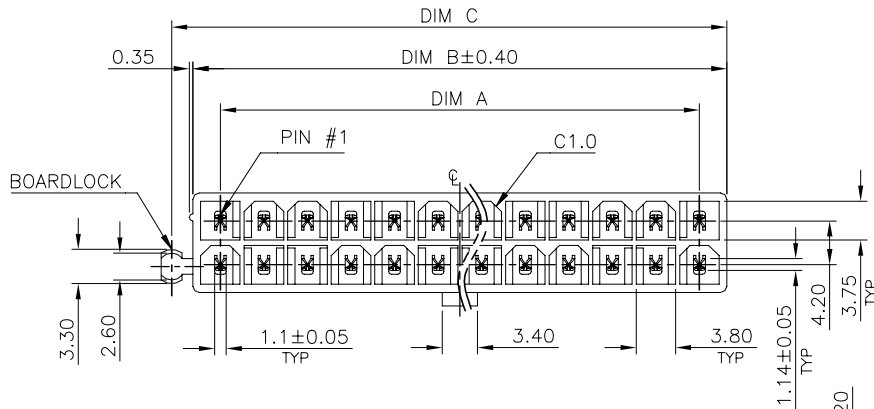

REEL&CAP	BLACK PA9T	3.11	25.2	30.5	32.55	14	6-1775099-9
TRAY	IVORY PA9T	1.52	8.4	13.7	15.75	6	6-1775099-6
		5.40	46.2	51.5	53.55	24	1-1775099-3
		1.13	4.2	9.5	11.55	4	1-1775099-2
		4.30	37.8	43.1	45.15	20	1-1775099-1
		3.90	33.6	38.9	40.95	18	1-1775099-0
	TRANSPARENCY PA9T	3.11	25.2	30.5	32.55	14	1775099-9
		2.71	21.0	26.3	28.35	12	1775099-8
		2.31	16.8	22.1	24.15	10	1775099-7
		1.52	8.4	13.7	15.75	6	1775099-6
		1.92	12.6	17.9	19.95	8	1775099-5
PACKAGE	HSG COLOR & MATERIAL	WEIGHT	DIM A	DIM B	DIM C	POS.	PART NUMBER

SUPERSEDED TO 1-1775099-3
 SUPERSEDED TO 1-1775099-2
 OBSOLETE

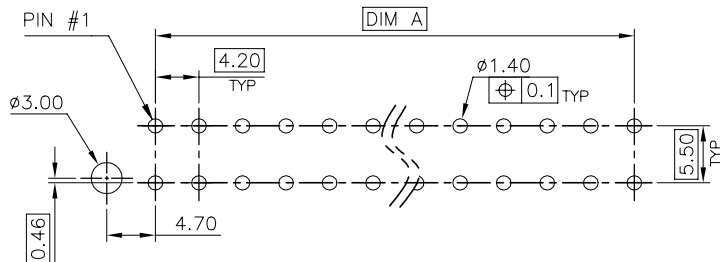

RECOMMENDED PCB LAYOUT
 TOLERANCE: ±0.05 T=1.6mm

ONE BOARDLOCK
 (LEFT)

THIS DRAWING IS A CONTROLLED DOCUMENT.

DIMENSIONS: mm	TOLERANCES UNLESS OTHERWISE SPECIFIED:	DWN B. HSING 15JUL2009	TE Connectivity ATX POWER CONNECTOR 4.2mm PITCH, VERTICAL, DIP TYPE
	0 PLC ± - 1 PLC ± 0.3 2 PLC ± 0.2 3 PLC ± 0.15 4 PLC ± - ANGLES ± 3°	CHK S. CHIEN 15JUL2009	
		APVD W. KODAMA 15JUL2009	
		NAME	
MATERIAL SEE NOTE	FINISH SEE NOTE	PRODUCT SPEC 108-57560	RESTRICTED TO
CUSTOMER DRAWING		APPLICATION SPEC	SCALE SHEET 1 OF 7 REV J

LOC	DIST	REVISIONS			
P	LTR	DESCRIPTION	DATE	DWN	APVD
DW		SEE SHEET 1.			

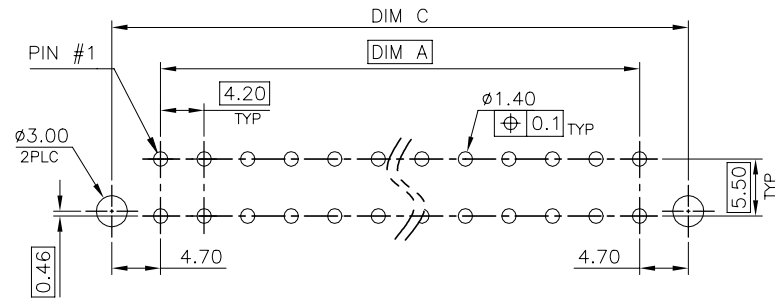
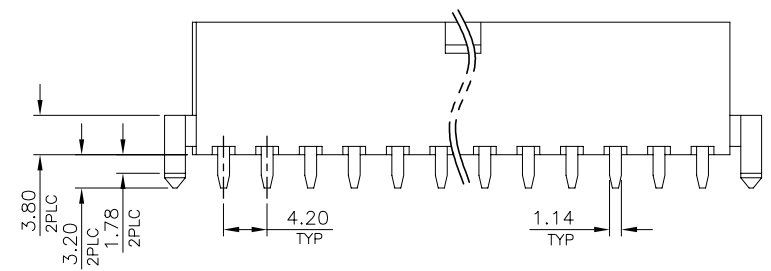
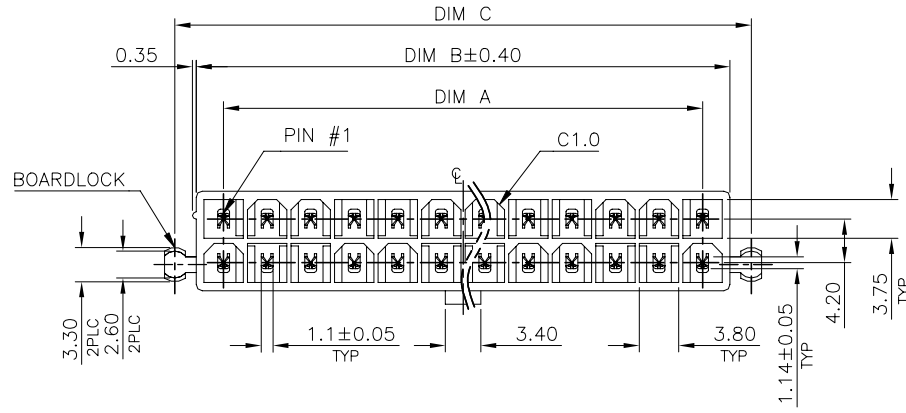

RECOMMENDED PCB LAYOUT
 TOLERANCE: ±0.05 T=1.6mm

- NOTE:
- MATERIAL:
HOUSING: PA9T, UL94 V-0, COLOR: (SEE TABLE).
CONTACTS: BRASS.
 - FINISH:
CONTACTS: 3.05um [120u"] MIN. MATTE-TIN.
1.27um [50u"] MIN. NICKEL UNDERPLATED ALL OVER.
 - WAVE SOLDER CAPABLE TO 265°C PER TEST SPEC.
109-202, CONDITION B.
 - NO TE LOGO AND DATE CODE ON THE PRODUCT WITH 4 POS.
 - THE KEY IDENTIFIED WAS SHOWN ON PAGE 5.
 - PACKING WITH TRAY.

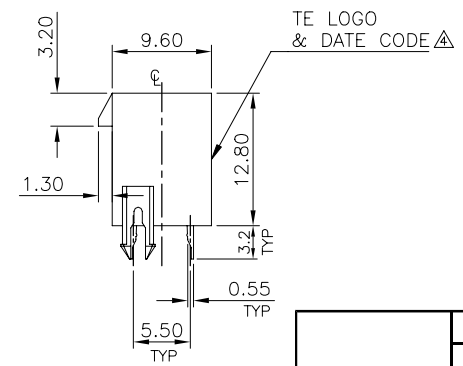

TWO BOARDLOCK

HSG COLOR & MATERIAL	WEIGHT	DIM A	DIM B	DIM C	POS.	PART NUMBER
IVORY PA9T	3.54	29.4	34.7	38.8	16	2-1775099-9
	5.43	46.2	51.5	55.6	24	2-1775099-8
	4.33	37.8	43.1	47.2	20	2-1775099-7
	3.93	33.6	38.9	43.0	18	2-1775099-6
	3.14	25.2	30.5	34.6	14	2-1775099-5
	2.74	21.0	26.3	30.4	12	2-1775099-4
	2.34	16.8	22.1	26.2	10	2-1775099-3
	1.95	12.6	17.9	22.0	8	2-1775099-2
	1.55	8.4	13.7	17.8	6	2-1775099-1
	1.16	4.2	9.5	13.6	4	2-1775099-0

THIS DRAWING IS A CONTROLLED DOCUMENT.

DIMENSIONS: mm	TOLERANCES UNLESS OTHERWISE SPECIFIED:	DWN	TE Connectivity ATX POWER CONNECTOR 4.2mm PITCH, VERTICAL, DIP TYPE
	0 PLC ± -	CHK	
	1 PLC ± 0.3	APVD	
	2 PLC ± 0.2	PRODUCT SPEC	
MATERIAL	FINISH	APPLICATION SPEC	NAME
		WEIGHT	SIZE A3 CAGE CODE 00779 DRAWING NO C=1775099 RESTRICTED TO
		CUSTOMER DRAWING	SCALE SHEET 2 OF 7 REV J

THIS DRAWING IS UNPUBLISHED.

RELEASED FOR PUBLICATION

© COPYRIGHT 2010

BY TYCO ELECTRONICS CORPORATION.

ALL RIGHTS RESERVED.

LOC DW DIST

REVISIONS

P	LTR	DESCRIPTION	DATE	DWN	APVD
		SEE SHEET 1.			

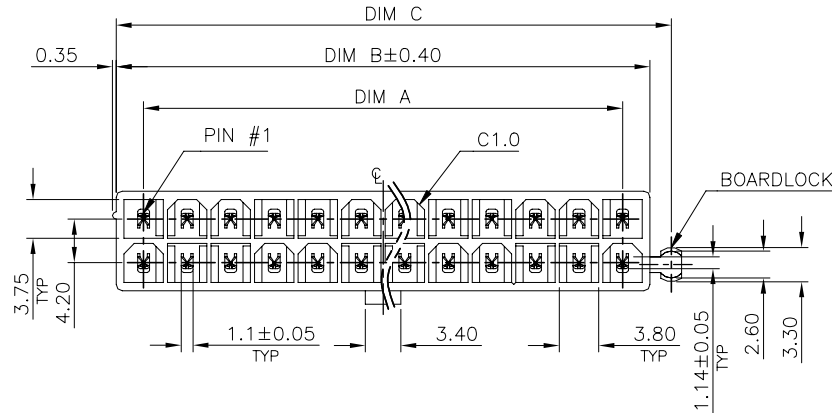

NOTE:

- MATERIAL:
HOUSING: PA9T, UL94 V-0, COLOR: (SEE TABLE).
CONTACTS: BRASS.
- FINISH:
CONTACTS: 3.05um [120u"] MIN. MATTE-TIN.
1.27um [50u"] MIN. NICKEL UNDERPLATED ALL OVER.
- WAVE SOLDER CAPABLE TO 265°C PER TEST SPEC.
109-202, CONDITION B.
- NO TE LOGO AND DATE CODE ON THE PRODUCT WITH 4 POS.
- THE KEY IDENTIFIED WAS SHOWN ON PAGE 5.
- PACKING WITH TRAY.

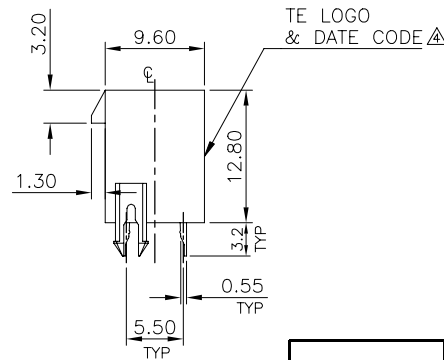
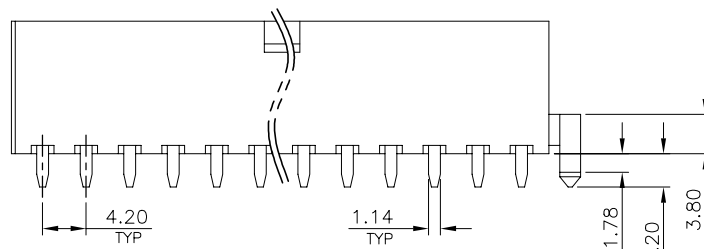

ONE BOARDLOCK (RIGHT)

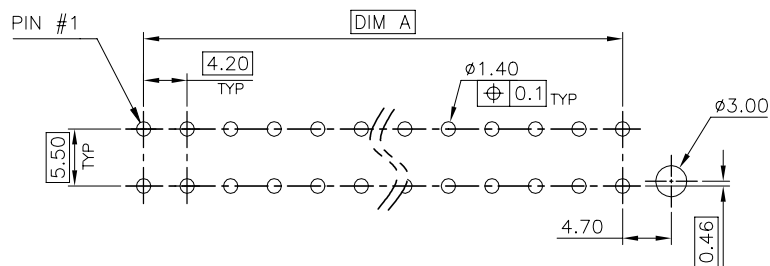

RECOMMENDED PCB LAYOUT
TOLERANCE: ±0.05 T=1.6mm

IVORY PA9T	5.40	46.2	51.5	53.55	24	3-1775099-8
	4.30	37.8	43.1	45.15	20	3-1775099-7
	3.90	33.6	38.9	40.95	18	3-1775099-6
	3.11	25.2	30.5	32.55	14	3-1775099-5
	2.71	21.0	26.3	28.35	12	3-1775099-4
	2.31	16.8	22.1	24.15	10	3-1775099-3
	1.92	12.6	17.9	19.95	8	3-1775099-2
	1.52	8.4	13.7	15.75	6	3-1775099-1
1.13	4.2	9.5	11.55	4	3-1775099-0	
HSG COLOR & MATERIAL	WEIGHT	DIM A	DIM B	DIM C	POS.	PART NUMBER

THIS DRAWING IS A CONTROLLED DOCUMENT.

DIMENSIONS:
mm



TOLERANCES UNLESS OTHERWISE SPECIFIED:

0 PLC	± -
1 PLC	± 0.3
2 PLC	± 0.2
3 PLC	± 0.15
4 PLC	± -
ANGLES	± 3'

MATERIAL

FINISH

DWN _____
 CHK _____
 APVD _____
 PRODUCT SPEC _____
 APPLICATION SPEC _____
 WEIGHT SEE TABLE
 CUSTOMER DRAWING

STE TE Connectivity

NAME
ATX POWER CONNECTOR
4.2mm PITCH, VERTICAL, DIP TYPE

SIZE	CAGE CODE	DRAWING NO	RESTRICTED TO
A3	00779	C=1775099	

SCALE _____ SHEET 3 OF 7 REV J

THIS DRAWING IS UNPUBLISHED. RELEASED FOR PUBLICATION
 © COPYRIGHT 2010 BY TYCO ELECTRONICS CORPORATION. ALL RIGHTS RESERVED.

LOC		DIST		REVISIONS			
P	LTR	DESCRIPTION		DATE	DWN	APVD	
SEE SHEET 1.							

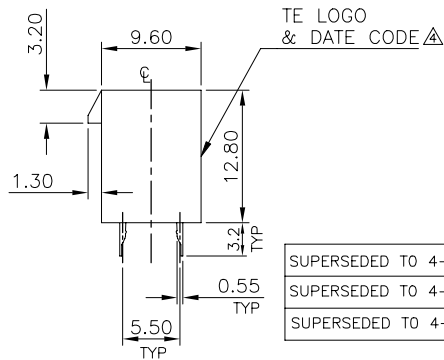
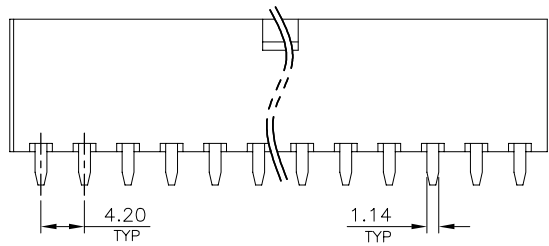
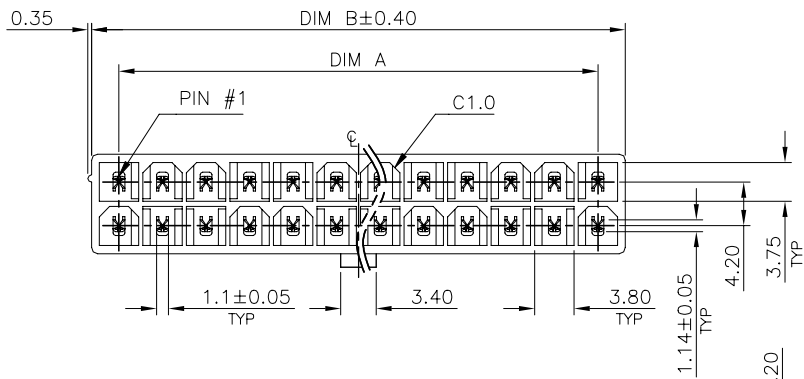

NO BOARDLOCK

- NOTE:
- MATERIAL:
HOUSING: PA9T, UL94 V-0, COLOR: (SEE TABLE).
CONTACTS: BRASS.
 - FINISH:
CONTACTS: 3.05um [120u"] MIN. MATTE-TIN.
1.27um [50u"] MIN. NICKEL UNDERPLATED ALL OVER.
 - WAVE SOLDER CAPABLE TO 265°C PER TEST SPEC.
109-202, CONDITION B.
 - NO TE LOGO AND DATE CODE ON THE PRODUCT WITH 4 POS.
 - THE KEY IDENTIFIED WAS SHOWN ON PAGE 5.
 - PACKING WITH TRAY.

SUPERSEDED TO 4-1775099-3	IVORY PA9T	2.28	16.8	22.1	10	5-1775099-3
SUPERSEDED TO 4-1775099-2		1.89	12.6	17.9	8	5-1775099-2
SUPERSEDED TO 4-1775099-1		1.49	8.4	13.7	6	5-1775099-1
IVORY PA9T	5.37	46.2	51.5	24	4-1775099-8	
	4.27	37.8	43.1	20	4-1775099-7	
	3.87	33.6	38.9	18	4-1775099-6	
	3.08	25.2	30.5	14	4-1775099-5	
	2.68	21.0	26.3	12	4-1775099-4	
	2.28	16.8	22.1	10	4-1775099-3	
	1.89	12.6	17.9	8	4-1775099-2	
	1.49	8.4	13.7	6	4-1775099-1	
	1.10	4.2	9.5	4	4-1775099-0	
	HSG COLOR & MATERIAL	WEIGHT	DIM A	DIM B	POS.	PART NUMBER

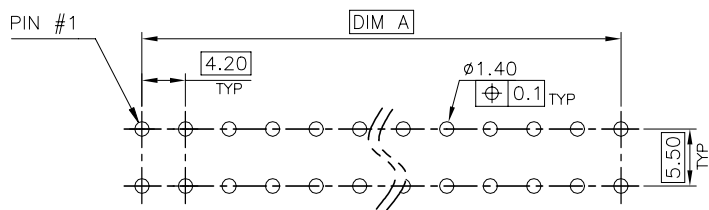

RECOMMENDED PCB LAYOUT
 TOLERANCE: ±0.05 T=1.6mm

THIS DRAWING IS A CONTROLLED DOCUMENT.

DIMENSIONS: mm	TOLERANCES UNLESS OTHERWISE SPECIFIED:	DWN	TE Connectivity		
0 PLC ± - 1 PLC ± 0.3 2 PLC ± 0.2 3 PLC ± 0.15 4 PLC ± - ANGLES ± 3°		CHK	NAME		
MATERIAL	FINISH	APVD	ATX POWER CONNECTOR 4.2mm PITCH, VERTICAL, DIP TYPE		
		PRODUCT SPEC	SIZE	CAGE CODE	DRAWING NO
		APPLICATION SPEC	A3	00779	C=1775099
		WEIGHT	RESTRICTED TO		
		CUSTOMER DRAWING	SCALE	SHEET	REV
				4 OF 7	J

THIS DRAWING IS UNPUBLISHED. RELEASED FOR PUBLICATION
 © COPYRIGHT 2010 BY TYCO ELECTRONICS CORPORATION. ALL RIGHTS RESERVED.

LOC		DIST		REVISIONS			
P	LTR	DESCRIPTION		DATE	DWN	APVD	
DW				SEE SHEET 1.			

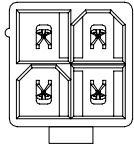

4 POS

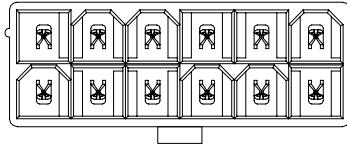

12 POS

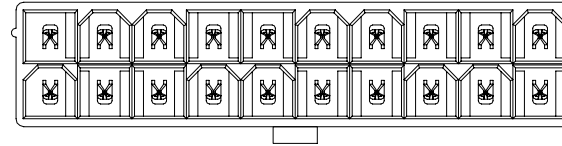

20 POS

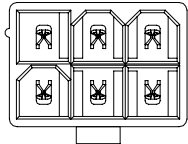

6 POS

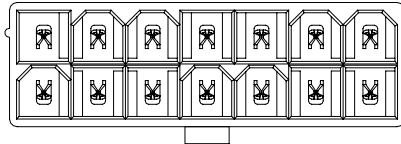

14 POS

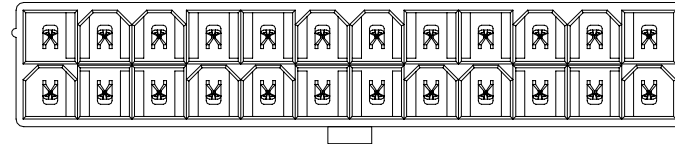

24 POS

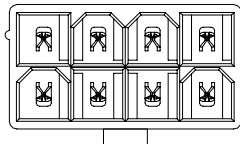

8 POS

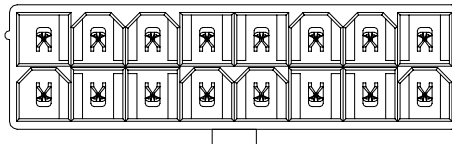

16 POS

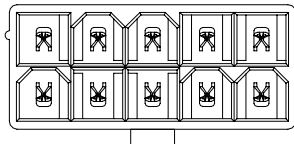

10 POS

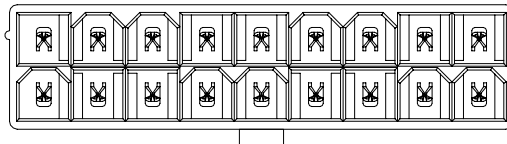

18 POS

KEY POSITION IDENTIFIED
(TOP VIEW)

THIS DRAWING IS A CONTROLLED DOCUMENT.		DWN _____		TE Connectivity	
DIMENSIONS: mm		CHK _____			
		TOLERANCES UNLESS OTHERWISE SPECIFIED:		APVD _____	
MATERIAL _____		FINISH _____		PRODUCT SPEC _____	
				APPLICATION SPEC _____	
				WEIGHT _____	
				CUSTOMER DRAWING	
				SIZE: A3 CAGE CODE: 00779 C=1775099	
				SCALE: _____ SHEET: 5 OF 7 REV: J	

THIS DRAWING IS UNPUBLISHED. RELEASED FOR PUBLICATION
 © COPYRIGHT 2010 BY TYCO ELECTRONICS CORPORATION. ALL RIGHTS RESERVED.

LOC		DIST		REVISIONS			
P	LTR	DESCRIPTION		DATE	DWN	APVD	
		SEE SHEET 1.					

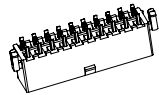
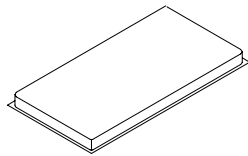

QUANTITY SEE TABLE

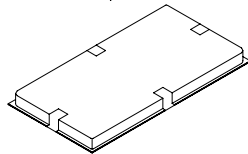
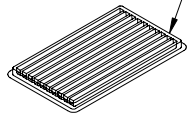

10 TRAY

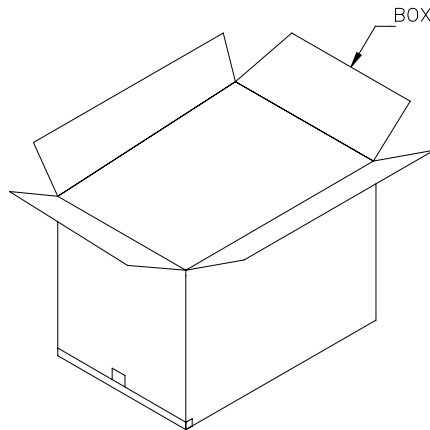
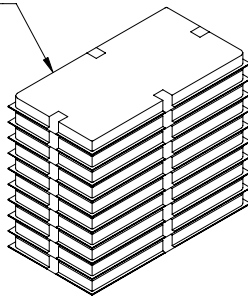

BOX

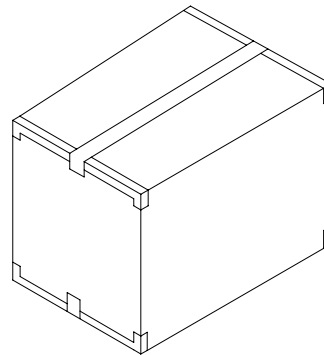

NOTES:

- 1. TRAY : PVC, SIZE: 330mm(L)X 265mm(W)X 22mm(H).
- 2. BOX : CORRUGATED, SIZE: 350mm(L)X 279mm(W)X 195mm(H).
- 3. QUANTITY: SEE TABLE.

GROSS WEIGHT	NET WEIGHT	PCS /TRAY	TRAYS /BOX	PCS /BOX	POS.	NO. OF BOARDLOCK
5.94	4.34	80	10	800	24	2
5.93	4.33	100	10	1000	20	
5.53	3.93	100	10	1000	18	
5.85	4.25	120	10	1200	16	
6.00	4.40	140	10	1400	14	
5.98	4.38	160	10	1600	12	
5.81	4.21	180	10	1800	10	
5.89	4.29	220	10	2200	8	
5.94	4.34	280	10	2800	6	
5.78	4.18	360	10	3600	4	
5.92	4.32	80	10	800	24	1
5.90	4.30	100	10	1000	20	
6.28	4.68	120	10	1200	18	
5.95	4.35	140	10	1400	14	
5.94	4.34	160	10	1600	12	
6.22	4.62	200	10	2000	10	
6.21	4.61	240	10	2400	8	
6.16	4.56	300	10	3000	6	
6.35	4.75	420	10	4200	4	
5.90	4.30	80	10	800	24	
5.87	4.27	100	10	1000	20	
6.24	4.64	120	10	1200	18	
5.91	4.31	140	10	1400	14	
6.42	4.82	180	10	1800	12	
6.16	4.56	200	10	2000	10	
6.51	4.91	260	10	2600	8	
6.67	5.07	340	10	3400	6	
6.88	5.28	480	10	4800	4	

THIS DRAWING IS A CONTROLLED DOCUMENT.

DIMENSIONS: mm



TOLERANCES UNLESS OTHERWISE SPECIFIED:
 0 PLC ± -
 1 PLC ± 0.3
 2 PLC ± 0.2
 3 PLC ± 0.15
 4 PLC ANGLES ± 3'

MATERIAL FINISH

DWN
 CHK
 APVD
 PRODUCT SPEC
 APPLICATION SPEC
 WEIGHT
 CUSTOMER DRAWING



NAME
 ATX POWER CONNECTOR
 4.2mm PITCH, VERTICAL, DIP TYPE

SIZE CAGE CODE DRAWING NO RESTRICTED TO
 A3 00779 C=1775099

SCALE SHEET 6 OF 7 REV J

THIS DRAWING IS UNPUBLISHED. RELEASED FOR PUBLICATION
 © COPYRIGHT 2010 BY TYCO ELECTRONICS CORPORATION. ALL RIGHTS RESERVED.

LOC	DIST	REVISIONS			
P	LTR	DESCRIPTION	DATE	DWN	APVD
DW		SEE SHEET 1.			

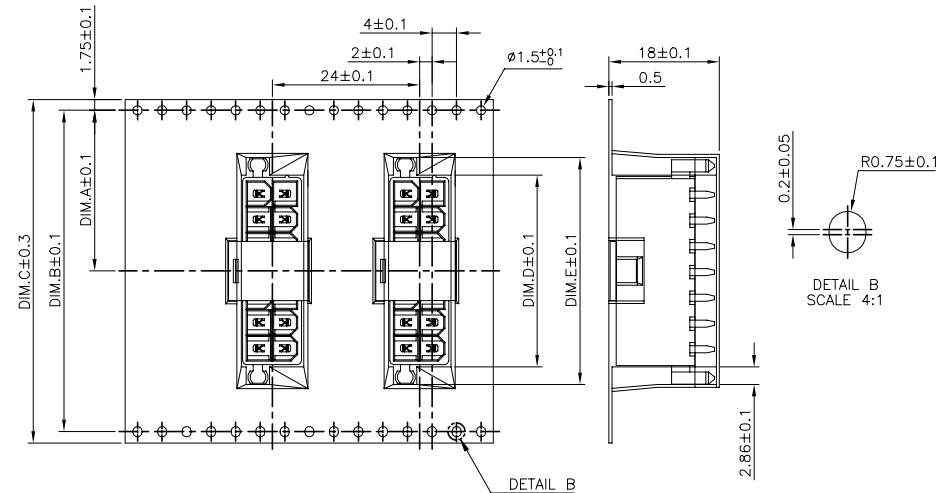
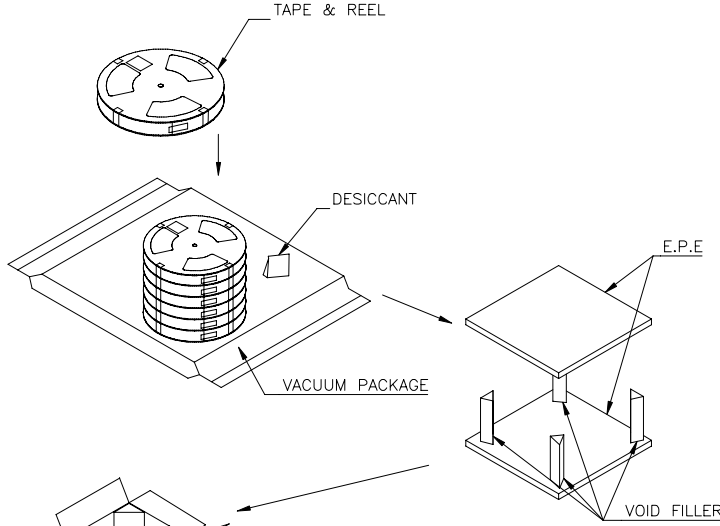
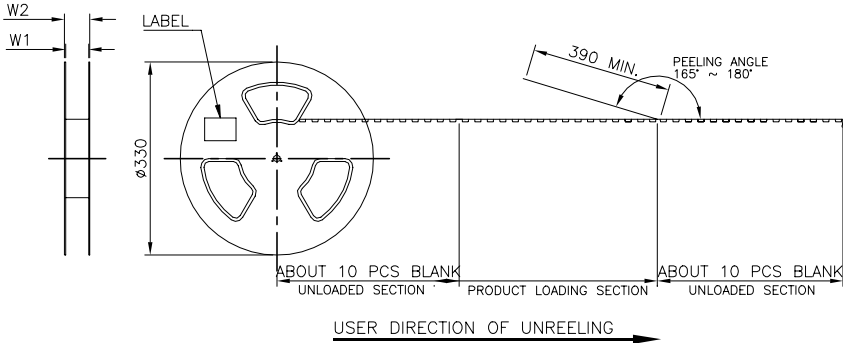

- NOTES:
 1. MATERIAL:
 BOX: FIBREBOARD, CORRUGATED, DOUBLE WALL.
 COVER TAPE: PET, TRANSPARENT COLOR.
 CARRIER TAPE: POLYSTYRENES, BLACK COLOR.
 REEL: POLYSTYRENES, BLUE COLOR.
 BAG: POLYETHYLENE.
 2. PEELING STRENGTH: 0.1 ~ 1.3 N (10 ~ 130 GRAMS)
 3. PEELING SPEED: 300 mm/min.
 4. EACH BAG SHALL BE INCLUDED DESICCANT.

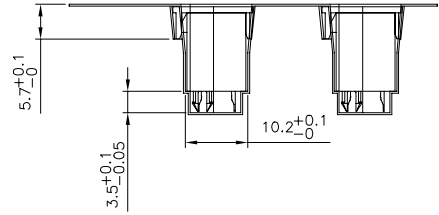

60.4	56.4	37.0	31.28	56.0	52.4	26.2	5.7 KG	2.40 KG	140	5	700	14	6-1775099-9
W2	W1	DIM. E	DIM. D	DIM. C	DIM. B	DIM. A	GROSS WEIGHT	NET WEIGHT	PCS/ REEL	REEL/ BOX	PCS/ BOX	POS.	PART NUMBER

THIS DRAWING IS A CONTROLLED DOCUMENT.

DIMENSIONS: mm	TOLERANCES UNLESS OTHERWISE SPECIFIED: 0 PLC ± - 1 PLC ± 0.3 2 PLC ± 0.2 3 PLC ± 0.15 4 PLC ± - ANGLES ± 3'	DWN CHK APVD PRODUCT SPEC APPLICATION SPEC WEIGHT CUSTOMER DRAWING	NAME ATX POWER CONNECTOR 4.2mm PITCH, VERTICAL, DIP TYPE
MATERIAL	FINISH	SIZE A3	CAGE CODE 00779
		DRAWING NO C=1775099	RESTRICTED TO
		SCALE	SHEET 7 OF 7
		REV	J

X-ON Electronics

Largest Supplier of Electrical and Electronic Components

Click to view similar products for [Power to the Board](#) category:

Click to view products by [TE Connectivity](#) manufacturer:

Other Similar products are found below :

[6450171-4](#) [6450552-7](#) [6600323-8](#) [6643429-1](#) [6646040-2](#) [6651939-1](#) [6766604-1](#) [120959-1](#) [1393557-2](#) [1393532-2](#) [1393532-3](#) [1393532-4](#)
[1393557-1](#) [1600812-5](#) [1-6450861-2](#) [1744132-7](#) [1761122-1](#) [1766250-1](#) [1892109-1](#) [2-6450860-5](#) [2-6450870-0](#) [1-6450161-4](#) [1-6450850-6](#) [1-](#)
[6450869-6](#) [1645526-2](#) [1-6600130-0](#) [2005243-2](#) [377-0020-11130](#) [TE34-12-16P-F0](#) [51700-10201602AALF](#) [5-6450830-6](#) [5646956-4](#) [377-](#)
[0080-11131A](#) [4-6450830-9](#) [4-6600333-3](#) [10125416-4050LF](#) [10130248-005LF](#) [6600320-3](#) [3-6450860-5](#) [1888123-2](#) [6450166-1](#) [6643978-1](#)
[6766605-1](#) [701-15-02109](#) [N11444](#) [6651938-1](#) [6450810-7](#) [46437-1112](#) [1-1589677-8](#) [5646956-5](#)