

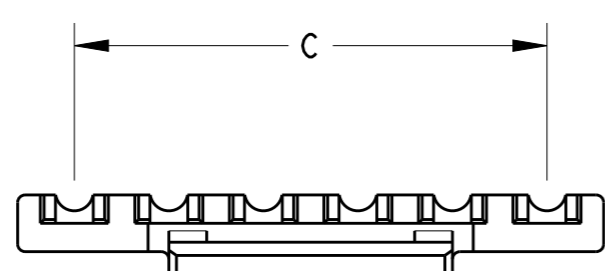

THIS DRAWING IS UNPUBLISHED. RELEASED FOR PUBLICATION
 © COPYRIGHT - BY - TE CONNECTIVITY ALL RIGHTS RESERVED.

LOC	DIST	REVISIONS					
-	-	P	LTR	DESCRIPTION	DATE	DWN	APVD
		A		INITIAL RELEASE	21FEB2012	ZHJ	E.K
		B		ADD 4P/7P PRODUCT	28MAY2013	HJ.Z	YH.M

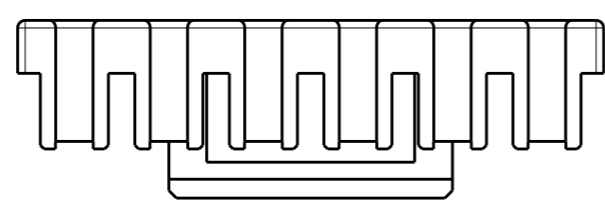
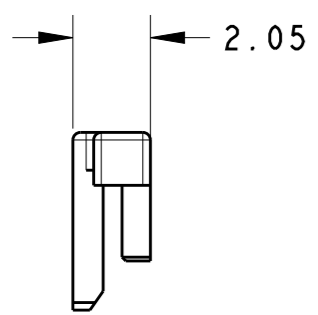
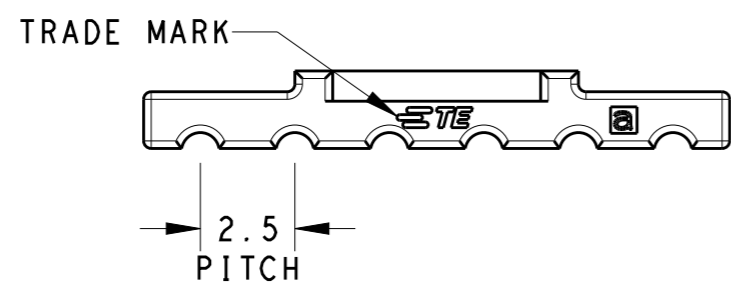
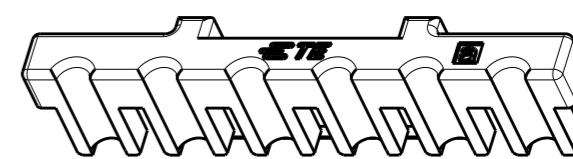
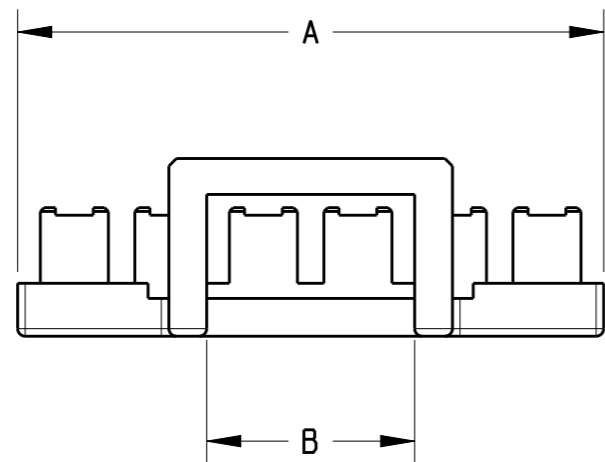

*The part is assembled with plug housing: X-1971793-X

17.5	8.4	20.5	8	8-1971794-1
15	8.4	18	7	7-1971794-1
12.5	5.5	15.5	6	6-1971794-1
10	3.3	13	5	5-1971794-1
7.5	3.7	10.5	4	4-1971794-1
5	2.5	8	3	3-1971794-1
2.5	2.4	5.5	2	2-1971794-1
C	B	A	POS	P/N

THIS DRAWING IS A CONTROLLED DOCUMENT.		DWN HJ.M 28MAY2013	 TE Connectivity	
DIMENSIONS: mm		CHK HJ.M 28MAY2013		
TOLERANCES UNLESS OTHERWISE SPECIFIED:		APVD HJ.M 28MAY2013	NAME TPA, 2.5 PITCH NEXT GENERATION GI CONNECTOR	
0 PLC ±- 1 PLC ±0.3 2 PLC ±0.13 3 PLC ±0.013 4 PLC ±0.0001 ANGLES ±-		PRODUCT SPEC 108-106077	RESTRICTED TO	
MATERIAL PA66 GF		FINISH -	SIZE A3	CAGE CODE -
		WEIGHT -	DRAWING NO C-1971794	RESTRICTED TO -
		Customer Drawing	SCALE /	SHEET 1 OF 1 REV B

X-ON Electronics

Largest Supplier of Electrical and Electronic Components

Click to view similar products for [Headers & Wire Housings](#) category:

Click to view products by [TE Connectivity](#) manufacturer:

Other Similar products are found below :

[95000-104TRLF](#) [10135584-644402LF](#) [DF62W-EP2022PCA](#) [95000-106TRLF](#) [DF62W-2022SCA](#) [DF62W-EP2022PC](#) [2203348](#) [DF62W-2022SC](#) [1084018](#) [1029039](#) [1084017](#) [802-10-012-10-002000](#) [1112640](#) [1112639](#) [891-007-9SS-BST1T](#) [000-34000](#) [0008550134](#) [0009482033](#) [0009507031](#) [57102-F02-18ULF](#) [57102-S06-03LF](#) [57202-S52-04LF](#) [PCN6-15S-2.5E](#) [0039019024](#) [58102-G61-06LF](#) [582553-1](#) [0009485154](#) [0009508121](#) [0022285053](#) [0050291907](#) [018731A](#) [LY20-4P-DT1-P1E-BR](#) [02.125.8002.8](#) [60101931](#) [60598-1 \(Cut Strip\)](#) [M1625-3R/100](#) [61062-3](#) [61082-181009](#) [CSU011177004](#) [636-1427](#) [638009-1](#) [641938-9](#) [641991-4](#) [644168-1](#) [644827-2](#) [647662-1](#) [65039-019ELF](#) [65692-001LF](#) [65781-018](#) [65781-047](#)