



Raychem

TE Internal #: 2820003010

Hook Up Wire, Spec 44, 600V Hook Up Wire Voltage Rating, 16AWG Wire Size, White Hook Up Wire Wire Color, Operating Temperature Range -65 – 150 °C

[View on TE.com >](#)

Wire & Cable > Hook Up Wire



Hook Up Wire Cable Type: **Spec 44**

Hook Up Wire Voltage Rating: **600 V**

Hook Up Wire Insulation Material: **Modified Radiation Cross-linked PVDF**

Hook Up Wire Conductor Material: **Tin-Coated Copper**

Hook Up Wire Wire Color: **White**

Features

Product Type Features

Cable Style	Primary
Product Type	Cable
Product Classification	Cable - High Performance - Spec 44, 55 & RCW
Hook Up Wire Cable Type	Spec 44

Configuration Features

Number of Conductors	1
Number of Strands	19

Electrical Characteristics

Hook Up Wire Voltage Rating	600 V
-----------------------------	-------

Body Features

Hook Up Wire Insulation Material	Modified Radiation Cross-linked PVDF
Hook Up Wire Conductor Material	Tin-Coated Copper
Hook Up Wire Wire Color	White

Dimensions

Overall Outside Diameter	1.83 mm[.072 in]
Wire Diameter	1.83 mm[.072 in]



Conductor Diameter	1.42 mm[.056 in]
Strand Size	29 AWG
Wire Size	16 AWG

Usage Conditions

Operating Temperature Range	-65 – 150 °C
-----------------------------	--------------

Other

Wire Source	United Kingdom
-------------	----------------

Product Compliance

[For compliance documentation, visit the product page on TE.com>](#)

EU RoHS Directive 2011/65/EU	Compliant
EU ELV Directive 2000/53/EC	Compliant
China RoHS 2 Directive MIIT Order No 32, 2016	No Restricted Materials Above Threshold
EU REACH Regulation (EC) No. 1907/2006	Current ECHA Candidate List: JUL 2021 (219) Candidate List Declared Against: JUL 2021 (219) Does not contain REACH SVHC
Halogen Content	Out of Scope - excluded from Halogen requirements
Solder Process Capability	Not applicable for solder process capability

Product Compliance Disclaimer

This information is provided based on reasonable inquiry of our suppliers and represents our current actual knowledge based on the information they provided. This information is subject to change. The part numbers that TE has identified as EU RoHS compliant have a maximum concentration of 0.1% by weight in homogenous materials for lead, hexavalent chromium, mercury, PBB, PBDE, DBP, BBP, DEHP, DIBP, and 0.01% for cadmium, or qualify for an exemption to these limits as defined in the Annexes of Directive 2011/65/EU (RoHS2). Finished electrical and electronic equipment products will be CE marked as required by Directive 2011/65/EU. Components may not be CE marked. Additionally, the part numbers that TE has identified as EU ELV compliant have a maximum concentration of 0.1% by weight in homogenous materials for lead, hexavalent chromium, and mercury, and 0.01% for cadmium, or qualify for an exemption to these limits as defined in the Annexes of Directive 2000/53/EC (ELV). Regarding the REACH Regulation, the information TE provides on SVHC in articles for this part number is based on the latest European Chemicals Agency (ECHA) 'Guidance on requirements for substances in articles' posted at this URL: <https://echa.europa.eu/guidance-documents/guidance-on-reach>

Compatible Parts



TE Part # 650076-000
D-436-38

Customers Also Bought

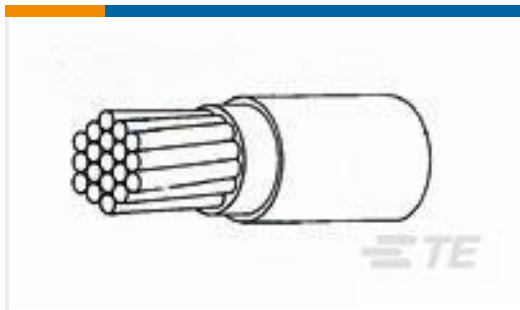

TE Part #2820223021
44A0111-20-2

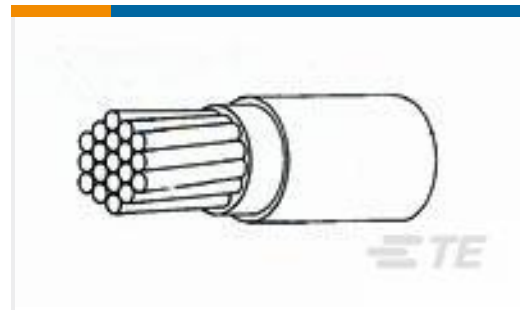

TE Part #2820103008
44A0111-18-0

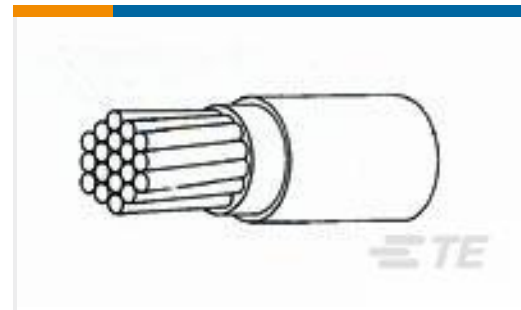

TE Part #2820053008
44A0111-16-5

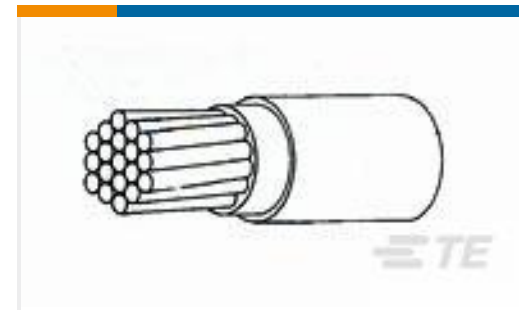

TE Part #2820323006
44A0111-22-2

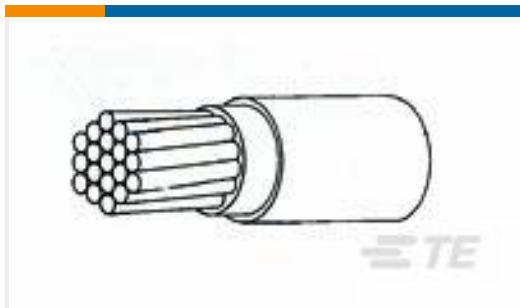

TE Part #2820093010
44A0111-16-9

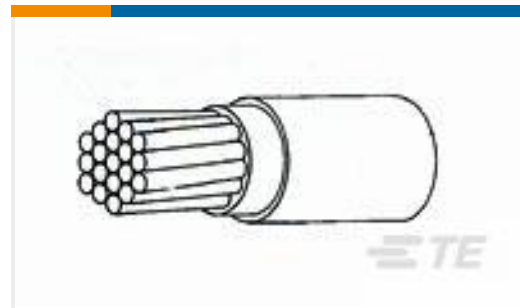

TE Part #2820203012
44A0111-20-0

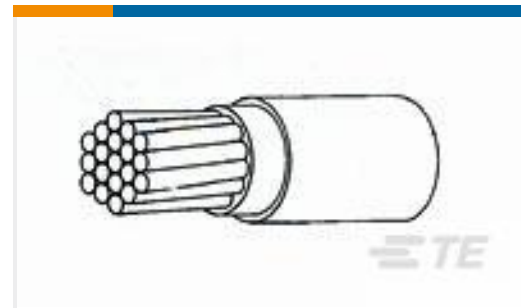

TE Part #2820303009
44A0111-22-0

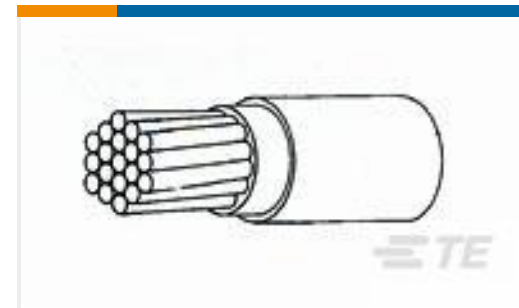

TE Part #2820023007
44A0111-16-2



TE Part #3-1105051-1
HN.D-C-BU.AG.0,75



TE Part #3-1105050-1
HN.D-C-STI.AG.0,75

Documents

Product Drawings

[44A0111-16-0](#)

English

Datasheets & Catalog Pages

[1654025_Sec9_SPEC44](#)

English

[Raychem Wire and Cable Quick Reference Guide](#)

English

44A0111-16-0

Hook Up Wire, Spec 44, 600V Hook Up Wire Voltage Rating, 16AWG Wire Size, White
Hook Up Wire Wire Color, Operating Temperature Range -65 – 150 °C



X-ON Electronics

Largest Supplier of Electrical and Electronic Components

Click to view similar products for [Hook-up Wire](#) category:

Click to view products by [TE Connectivity](#) manufacturer:

Other Similar products are found below :

[8918-BRN-1000](#) [8920-DK-BLU-1000](#) [CR6328-000](#) [01776.38.01](#) [M22759/16-14-5-500FT](#) [7053-RED-1000](#) [7053-SLATE-1000](#) [F25935-000](#)
[F60898-000](#) [8055](#) [81044/12-18-9CS3209](#) [82A0811-4-9-G110](#) [83004-ORG-1000](#) [83005-LT-BLU-1000](#) [83025-VIO-1000](#) [8523-RED-100](#)
[8524-WHT-100](#) [8525-ORG-1000](#) [8530-BLK-1000](#) [8530-LT-BLU-100](#) [8538-009-1000](#) [8597-LT-BLU-100](#) [8898-BLK-100](#) [138498-000](#)
[E76065-000](#) [EPD50886A-20-9](#) [BFWUL3239-24-PINK](#) [C2015A.12.04](#) [C2015A.12.05](#) [C2015A.12.08](#) [C2015A.12.10](#) [C2015A.12.19](#)
[C2016A.12.05](#) [C2016A.12.07](#) [C2065A.12.02](#) [C77653-000](#) [220368-001](#) [8916-GRY-500](#) [8918-RED-100](#) [8919-DK-BLU-1000](#) [8919-YEL-100](#)
[8920-YEL-100](#) [9242833001](#) [933205-000](#) [282257-000](#) [2841/7-YELLOW-1000](#) [2842/7-ORANGE-100](#) [2842/7-RED-1000](#) [2843/19-BLUE-100](#)
[2843/1-YELLOW-100](#)