

ZONE	LT#	DESCRIPTION	DATE	APPROVED
I		REVISED PER ECR# T-62 55	1/2/80	J
J		REVISE PER DCR# T-28702	2/21/2001	M.HIGGY

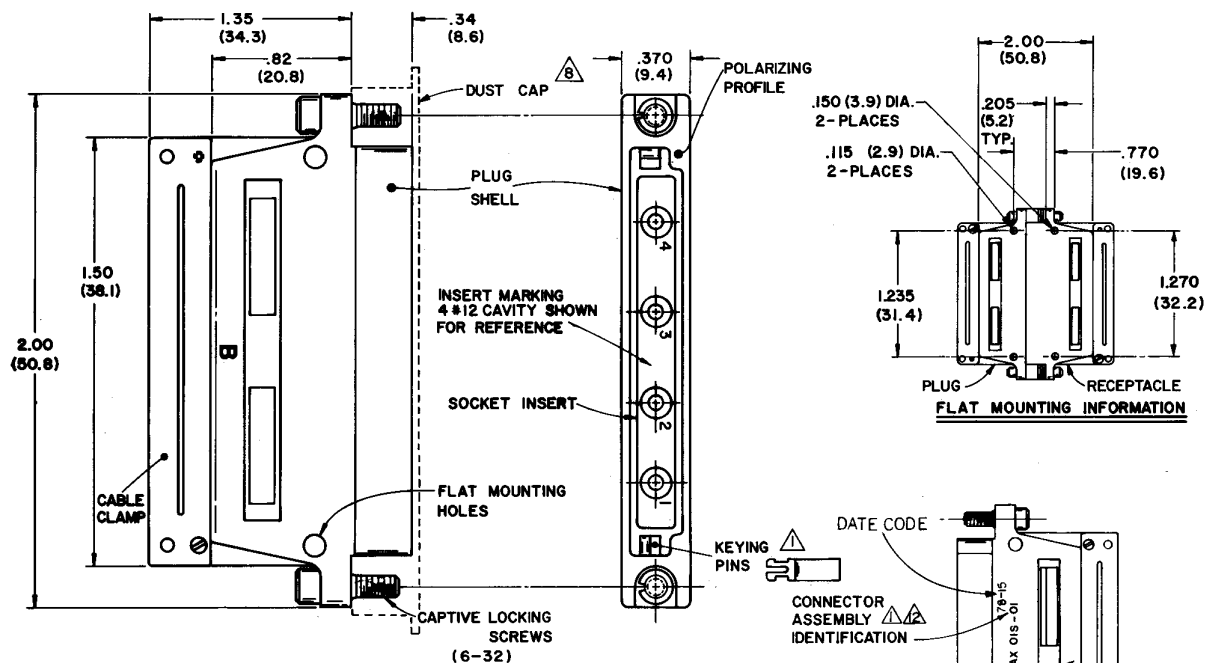

SOCKET CONTACT AND TOOLING INFORMATION

TABLE I			
CONTACT TYPE	MILITARY PART NO.	WIRE STRIP LENGTH	TERMINATION TOOL
SHIELDED CONTACT FOR COAX CABLE D-602-0095 OR D-602-0107		SEE DRAWING D-602-0095 OR D-602-0107	SEE DRAWING D-602-0095 OR D-602-0107
CONTACT FOR TWISTED PAIR D-602-0105		SEE DRAWING D-602-0105	SEE DRAWING D-602-0105
POWER CONTACT SIZE 12	M39029/5-12-12	1/4" TO 5/16"	M22520/1-01 POSITIONER M22520/1-02

TABLE II KEYING CODE CHART		
PART NUMBER	X X	POSITION OF KEYS
MTC XIP-COAX OIS-01	AA	KEY POSITION
	AB	KEY POSITION
	AC	KEY POSITION
	AD	KEY POSITION
	BA	KEY POSITION
	BB	KEY POSITION
	BC	KEY POSITION
	BD	KEY POSITION
	CA	KEY POSITION
	CB	KEY POSITION
	CC	KEY POSITION
	CD	KEY POSITION
	DA	KEY POSITION
	DB	KEY POSITION
	DC	KEY POSITION
MTC XIP-COAX OIS-01	DD	KEY POSITION

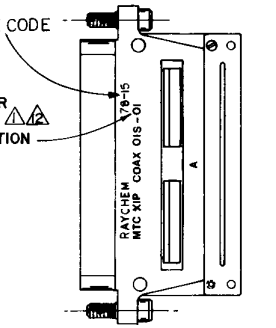

VIEW SHOWING IDENTIFICATION

NOTES:

- KEYING CODE DOES NOT FORM A PART OF RAYCHEM PART NUMBER SYSTEM AND SHOULD BE OMITTED WHEN ORDERING. KEYING PINS SUPPLIED UN-INSTALLED. SEE TABLE II FOR KEYING POSITIONS.
- COMPLETE CONNECTORS AND ACCESSORIES ARE INDIVIDUALLY BAGGED AND LABELED.
- REAR GROMMET INSERT WILL SEAL ON SMOOTH INSULATION FROM .097" TO .158" O.D.
- CONNECTOR DESIGNED FOR USE WITH POWER AND SHIELDED CONTACTS PER TABLE I.
- INSERTS ARE PERMANENTLY INSTALLED, CONTACTS MAY BE INSERTED AND REMOVED USING TOOL PER NOTE 8.
- ALL UNUSED CAVITIES TO BE SEALED USING SEALING PLUG NUMBER M83723-28-12.
- ALL CONTACTS SIZE 12 ARE INSERTED AND REMOVED USING TOOL NUMBER M83723-31-12.

- CONNECTOR SUPPLIED WITH A SHIPPING DUST CAP OVER ENGAGING END.
- CONNECTOR PLUG PART NO. MTCXIP-COAX OIS-01-AA. AA = KEYING CODE.
- MATES WITH RECEPTACLE CONNECTOR NO. MTCXIR-COAX OIP-01.
- CONNECTOR MATING REQUIREMENTS: 9 in. lbs. TORQUE FOR CAPTIVE LOCKING SCREWS.
- PART NUMBER VARIABLE:

MTC XIP-COAX OIS-01
 B=NICKEL PLATE PER MIL-C-26074
 C=CADMIUM PLATE PER QQ-P-416 OVER NICKEL UNDERPLATE

13. DIMENSIONS WITHOUT TOLERANCES ARE TO BE CONSIDERED FOR REFERENCE ONLY.

SPECIFICATION CONTROL DRAWING

ITEM	REV	PART NUMBER	DWG. OR SPEC.	PARIS LIST	DESCRIPTION
				UNLESS OTHERWISE SPECIFIED DIMENSIONS ARE IN INCHES AND TOLERANCES ARE .001	TYCO ELECTRONICS/RAYCHEM WIRE AND HARNESSING PRODUCTS 307 CONSTITUTION DRIVE MENLO PARK, CALIFORNIA 94025
				DRAWN: CRN 1-20-71	TITLE: CONNECTOR, PLUG, RECTANGULAR ENVIRONMENTAL, FIXED SOCKET INSERT - ONE INCH MTC SERIES
				CHECKED: [Signature]	
				APPROVED: [Signature] 2-24-76	
				APPROVED: [Signature] 6-4-76	
				APPROVED: [Signature] 4-9-77	
				CAD FILE: T28702a.b.c.d.TIF	SIZE: D CODE IDENT: NO 06000 DWG NO: D-652-0004
DO NOT SCALE THIS DRAWING				PROJECT: 6441-6037	SCALE: _____ WEIGHT: _____ SHEET: 1 OF 4

8 7 6 5 4 3 2 1

REVISIONS				
ZONE	LTR	DESCRIPTION	DATE	APPROVED
-	-	SEE SHEET 1		

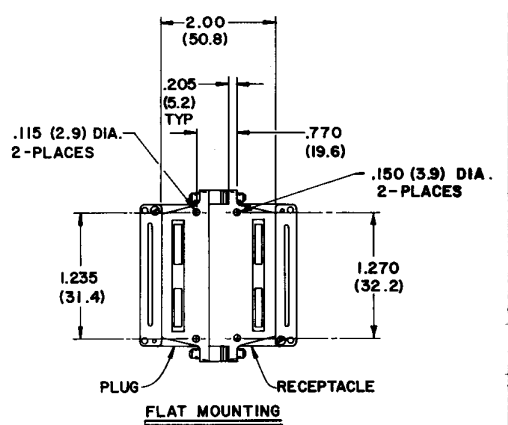
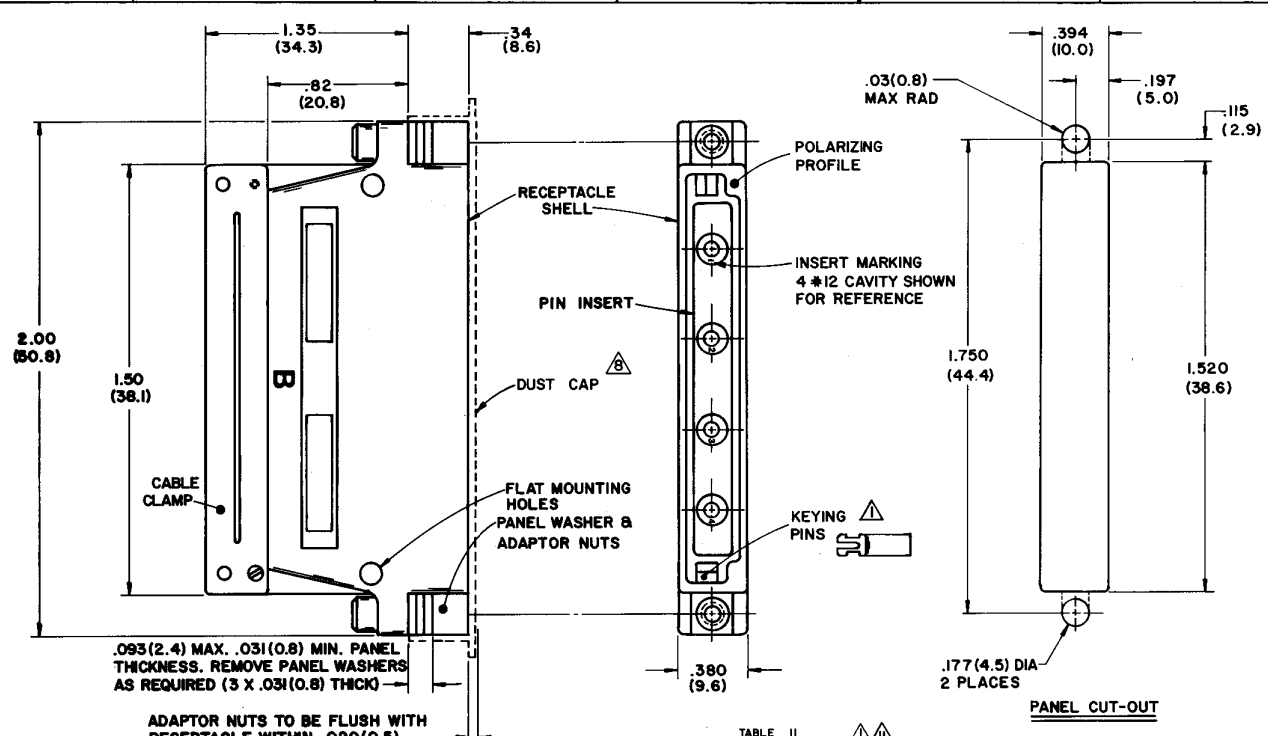

PIN CONTACT AND TOOLING INFORMATION

TABLE I

CONTACT TYPE	MILITARY PART NO.	WIRE STRIP LENGTH	TERMINATION TOOL
SHIELDED CONTACT FOR COAX CABLE D-602-0106 OR D-602-0094		SEE DRAWING D-602-0106 OR D-602-0094	SEE DRAWING D-602-0106 OR D-602-0094
CONTACT FOR TWISTED PAIR D-602-0104		SEE DRAWING D-602-0104	SEE DRAWING D-602-0104
POWER CONTACT SIZE 12	M39029/4-12-12	1/4" TO 5/16"	M22520/1-01 POSITIONER M22520/1-02

.093(2.4) MAX. .031(0.8) MIN. PANEL THICKNESS. REMOVE PANEL WASHERS AS REQUIRED (3 X .031(0.8) THICK)

ADAPTOR NUTS TO BE FLUSH WITH RECEPTACLE WITHIN .020(0.5)

NOTES:

- KEYING CODE DOES NOT FORM A PART OF RAYCHEM PART NUMBER SYSTEM AND BE OMITTED WHEN ORDERING. KEYING PINS SUPPLIED UN-INSTALLED. SEE TABLE II FOR KEYING POSITIONS.
- COMPLETE CONNECTORS AND ACCESSORIES ARE INDIVIDUALLY BAGGED AND LABELED.
- NEAR GROMMET INSERT WILL SEAL ON SMOOTH INSULATION FROM .097" TO .158" O.D.
- CONNECTOR DESIGNED FOR USE WITH POWER AND SHIELDED CONTACTS PER TABLE I.
- INSERTS ARE PERMANENTLY INSTALLED, CONTACTS MAY BE INSERTED & REMOVED USING TOOL PER NOTE 8.
- ALL UNUSED CAVITIES TO BE SEALED USING SEALING PLUG NUMBER M83723-28-12.
- ALL CONTACTS SIZE 12 ARE INSERTED AND REMOVED USING TOOL NUMBER M83723-31-12.
- CONNECTOR SUPPLIED WITH A SHIPPING DUST CAP OVER ENGAGING END.
- CONNECTOR RECEPTACLE PART NO. MTCXIR-COAX OIP-01- AA, AA + KEYING CODE
- MATES WITH PLUG CONNECTOR NO. MTCXIP-COAX OIS-01.
- PART NUMBER VARIABLE:
MTC XIR-COAX OIP-01
B-NICKEL PLATE PER MIL-C-26074
C-CADMIUM PLATE PER QQ-P-416 OVER NICKEL UNDERPLATE
- DIMENSIONS WITHOUT TOLERANCES ARE TO BE CONSIDERED FOR REFERENCE ONLY.

TABLE II KEYING CODE CHART

PART NUMBER	X X	POSITION OF KEYS
MTC XIR-COAX OIP-01	AA	1
	AB	2
	AC	3
	AD	4
	BA	5
	BB	6
	BC	7
	CA	8
	CB	9
	CC	10
	DA	11
	DB	12
	DC	13
	DD	14
MTC XIR-COAX OIP-01	DD	14

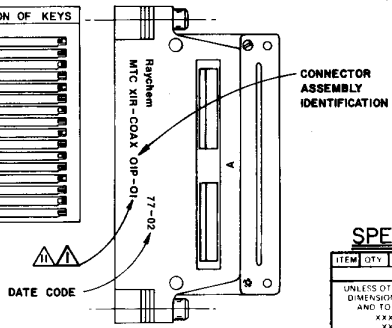

VIEW SHOWING IDENTIFICATION

SPECIFICATION CONTROL DRAWING

ITEM	QTY	PART NUMBER	UWG OR SPEC	DESCRIPTION
UNLESS OTHERWISE SPECIFIED DIMENSIONS ARE IN INCHES AND TOLERANCES ARE:				
XXX				WIRE AND HARNESSING PRODUCTS
XX				TYCOELECTRONICS/RAYCHEM 387 CONSTITUTION DRIVE
X				MENLO PARK, CALIFORNIA 94025
PARTS LIST				TITLE
DRAWN: CRN 7-20-77				CONNECTOR, RCPT, RECTANGULAR
CHECKED: [Signature]	APPROVED: [Signature]	DATE: 2-21-78		ENVIRONMENTAL, FIXED PIN INSERT
MATERIAL:	APPROVED: [Signature]	DATE: 2-21-78		ONE INCH MTC SERIES
APPROVED: [Signature]	DATE: 2-21-78			
FINISH:	CAD FILE: T28702b.TIF	SIZE: D	CODE IDENT: D-652-0004	DWG NO: J
PROJECT: 6441-G037	SCALE:	WEIGHT:	SHEET 2 OF 4	

DO NOT SCALE THIS DRAWING

NEXT ASSY USED ON APPLICATION

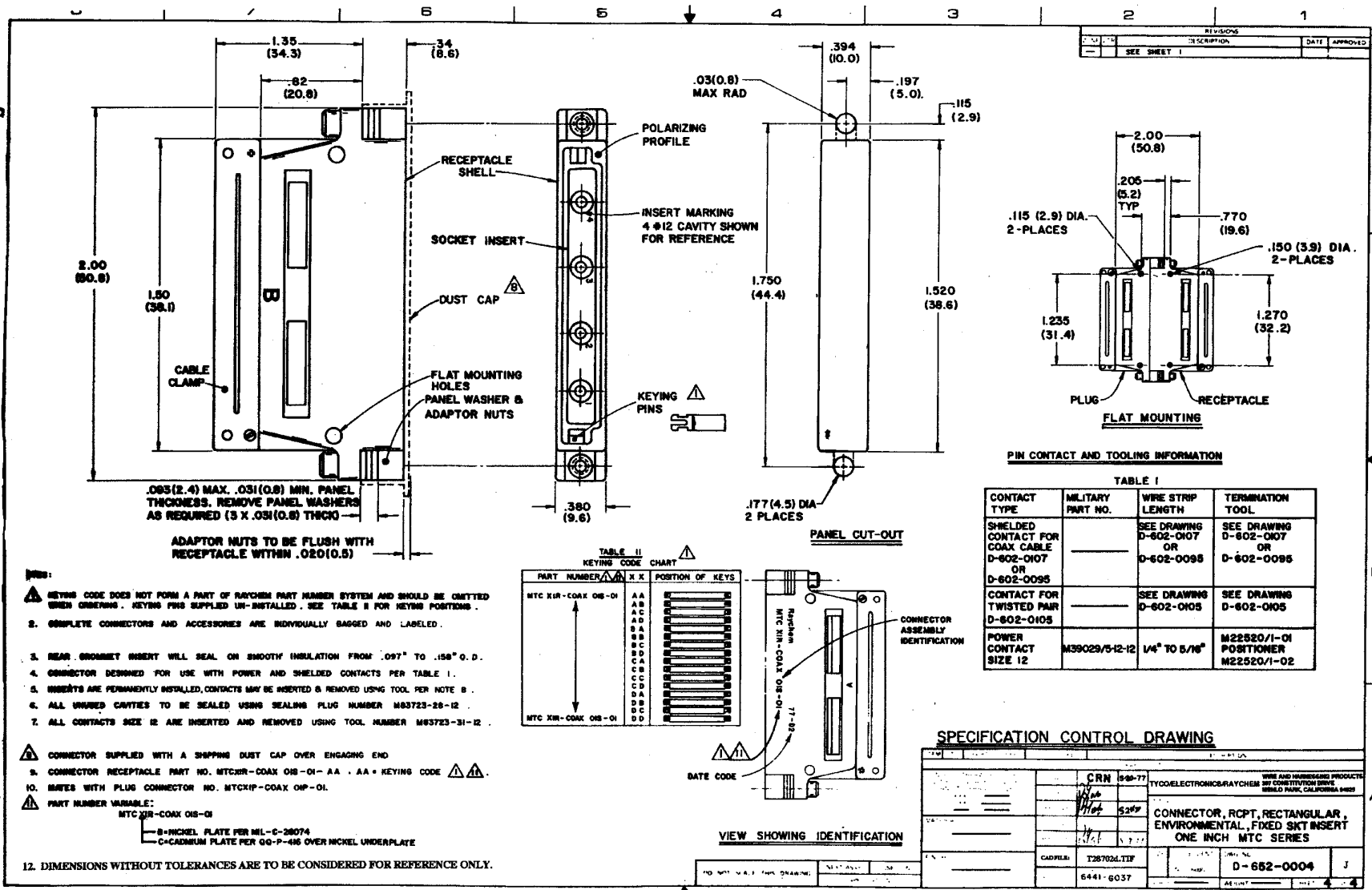

.093(2.4) MAX. .031(0.8) MIN. PANEL THICKNESS. REMOVE PANEL WASHERS AS REQUIRED (3 X .031(0.8) THICK)

ADAPTOR NUTS TO BE FLUSH WITH RECEPTACLE WITHIN .020(0.5)

- NOTES:**
- KEYING CODE DOES NOT FORM A PART OF RAYCHEM PART NUMBER SYSTEM AND SHOULD BE OMITTED WHEN ORDERING. KEYING PINS SUPPLIED UN-INSTALLED. SEE TABLE II FOR KEYING POSITIONS.
 - COMPLETE CONNECTORS AND ACCESSORIES ARE INDIVIDUALLY BARGED AND LABELED.
 - REAR BROWNET INSERT WILL SEAL ON SMOOTH INSULATION FROM .097" TO .158" O.D.
 - CONNECTOR DESIGNED FOR USE WITH POWER AND SHIELDED CONTACTS PER TABLE I.
 - INSERTS ARE PERMANENTLY INSTALLED, CONTACTS MAY BE INSERTED & REMOVED USING TOOL PER NOTE 9.
 - ALL UNUSED CAVITIES TO BE SEALED USING SEALING PLUG NUMBER M83723-28-12.
 - ALL CONTACTS SIZE 12 ARE INSERTED AND REMOVED USING TOOL NUMBER M83723-31-12.

- CONNECTOR SUPPLIED WITH A SHIPPING DUST CAP OVER ENGAGING END
- CONNECTOR RECEPTACLE PART NO. MTCXIR-COAX 018-01-AA. AA = KEYING CODE
- MADES WITH PLUG CONNECTOR NO. MTCXIP-COAX 018-01
- PART NUMBER VARIABLE:
MTCXIR-COAX 018-01
B-NICKEL PLATE PER MIL-C-28074
C-CADMIUM PLATE PER QQ-P-486 OVER NICKEL UNDERPLATE

12. DIMENSIONS WITHOUT TOLERANCES ARE TO BE CONSIDERED FOR REFERENCE ONLY.

TABLE II
KEYING CODE CHART

PART NUMBER	KEYING CODE	POSITION OF KEYS
MTC XIR-COAX 018-01	AA	1
	AB	2
	AC	3
	AD	4
	AA	5
	BB	6
	BC	7
	CA	8
	CB	9
	CC	10
	DA	11
	DB	12
	DC	13
MTC XIR-COAX 018-01	DD	14

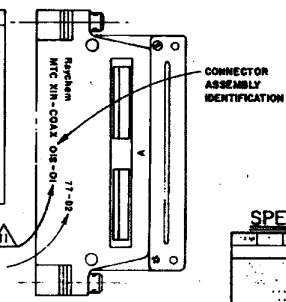

TABLE I
PIN CONTACT AND TOOLING INFORMATION

CONTACT TYPE	MILITARY PART NO.	WIRE STRIP LENGTH	TERMINATION TOOL
SHIELDED CONTACT FOR COAX CABLE D-602-0107 OR D-602-0095		SEE DRAWING D-602-0107 OR D-602-0095	SEE DRAWING D-602-0107 OR D-602-0095
CONTACT FOR TWISTED PAIR D-602-0105		SEE DRAWING D-602-0105	SEE DRAWING D-602-0105
POWER CONTACT SIZE 12	M39029/5-12-12	1/4" TO 5/16"	M22520/1-01 POSITIONER M22520/1-02

SPECIFICATION CONTROL DRAWING

CRN	949-77	WIRE AND HARDWARE PRODUCTS
TYCOELECTRONICS/RAYCHEM 387 CONSTITUTION DRIVE, WHEELER PARK, CALIFORNIA 94085		
CONNECTOR, RCPT, RECTANGULAR, ENVIRONMENTAL, FIXED SKT INSERT ONE INCH MTC SERIES		
CADFILE	T287024.TIF	D-652-0004
6441-6037		

X-ON Electronics

Largest Supplier of Electrical and Electronic Components

Click to view similar products for [Rack & Panel Connectors](#) category:

Click to view products by [TE Connectivity](#) manufacturer:

Other Similar products are found below :

[00170420102](#) [00171420202](#) [00171440002](#) [008026165000265](#) [00-8219-072-000-112P44](#) [008219072000112P5](#) [008219072000112P61](#) [00-8223-096-580-102](#) [02-014-013-5200-000](#) [00-8129-015-610-108](#) [613467-000](#) [CTJ112E01E-513](#) [CTJ116E03A-513](#) [M81714/63-22S L/C](#) [M81714/65-12-1](#) [66020-2](#) [CW8958-000](#) [699886-000](#) [D250-50632](#) [70.400.3240.0](#) [70.955.2453.3](#) [733753-000](#) [F22831-000](#) [780-522-DPX34RG8-02](#) [MMA25-0051R1](#) [MMA25-0341D1](#) [8660-501](#) [87.060.0053.0](#) [900709N001](#) [QRP4-12P-C\(01\)](#) [QR/P6-6S-C\(01\)](#) [AC-600003-004](#) [1218600-1](#) [D-659-0061](#) [DMC-MD 24 C-T](#) [1-445717-6](#) [1484398-2](#) [1484399-2](#) [1484469-2](#) [MR-34MG](#) [1484225-1](#) [1484398-1](#) [1484510-4](#) [1604997-2](#) [1663130-1](#) [1663767-7](#) [1663767-8](#) [MTC100-BF1-P31CS015](#) [MTC100-KT2-0083](#) [MTC100-KT2-0123-003](#)