

THIS DRAWING IS UNPUBLISHED. RELEASED FOR PUBLICATION  
 © COPYRIGHT 20 BY TYCO ELECTRONICS CORPORATION. ALL RIGHTS RESERVED.

LOC	DIST	REVISIONS					
GZ	00	P	LTR	DESCRIPTION	DATE	DWN	APVD
		C		ECR-09-007434	22APR2009	JS	JH
		D		ECR-09-012424	11JUN2009	JS	DB

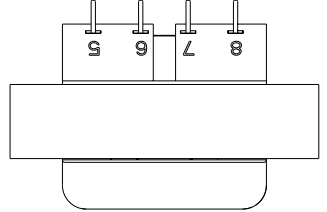
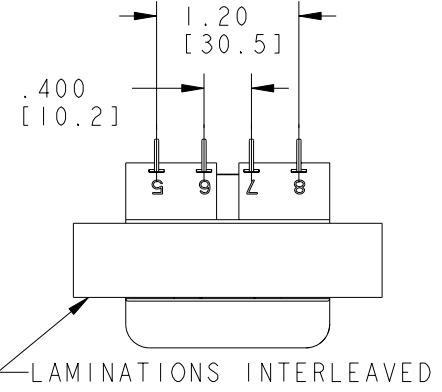
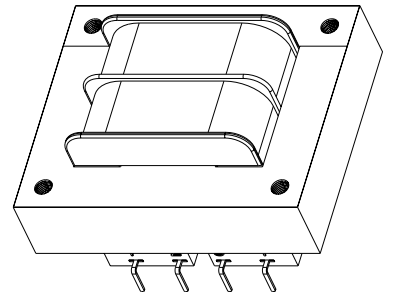
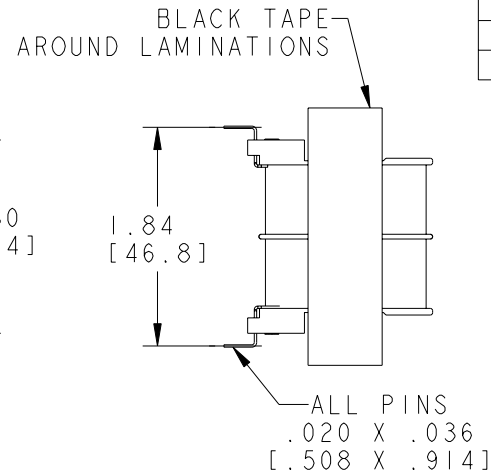
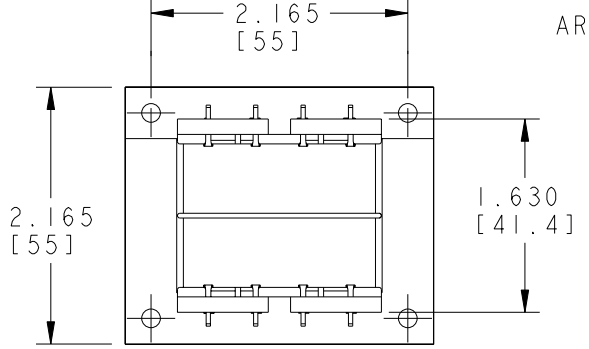
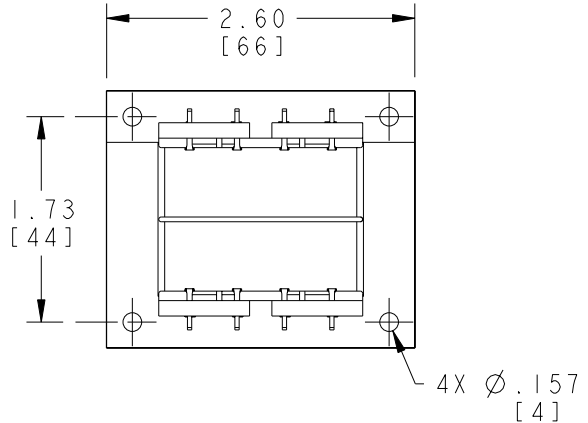
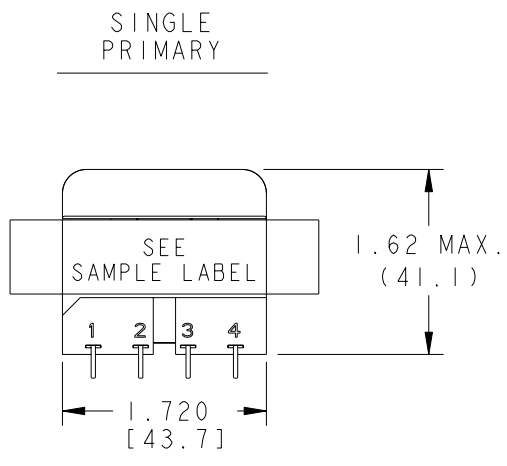
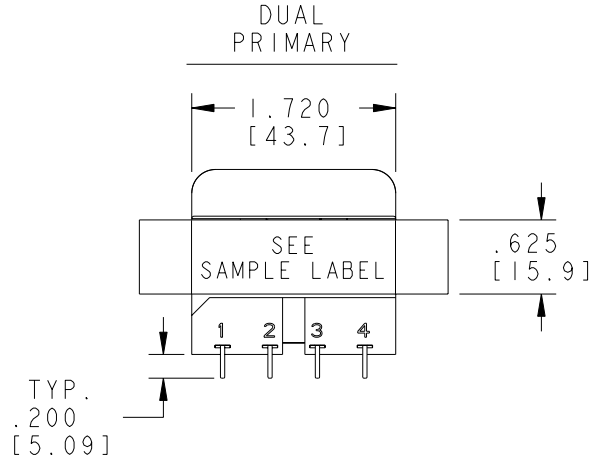

4900-XXXXRF65  
 50/60HZ 36VA SEC-6/12 VAC  
 MADE IN XXXX  
**Tyco Electronics**  
 [115V] [ ] [ ] [115V]  
 XXX (DATE CODE)

SAMPLE LABEL SCALE: 4:1  
 VOLTAGE ON LABEL WILL VARY PER MODEL NUMBER

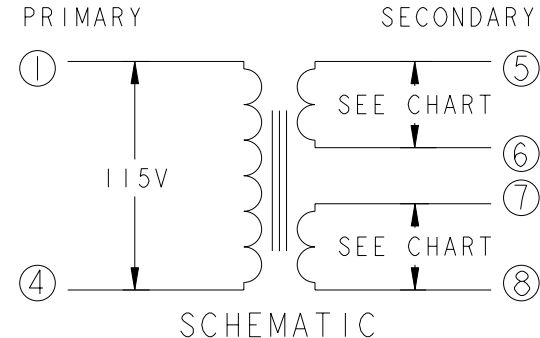
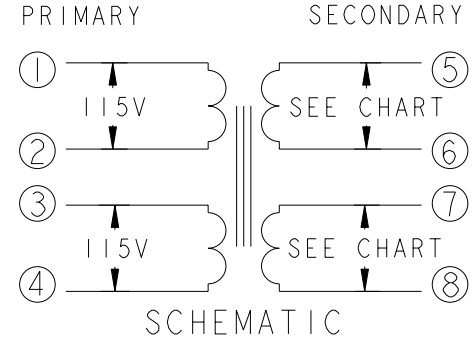

CERTIFICATION: UL/CUL FILE NO. E102980 HZ. 50/60 V. A. 36  
 DIMENSIONS FOR REFERENCE ONLY.

PRIMARY	SECONDARY		P. U. PART NUMBER	TYCO ELECTRONICS PART NUMBER
	SERIES	PARALLEL		
115 VAC	12 VCT	6 VAC	4900-8012RF65	1672327-2
115 VAC	12.6 VCT	6.3 VAC	4900-8013RF65	1672327-3
115 VAC	24 VCT	12 VAC	4900-8024RF65	1672327-6
115 VAC	28 VCT	14 VAC	4900-8028RF65	1672327-7
115 VAC	48 VCT	24 VAC	4900-8048RF65	1-1672327-0
115/230 VAC	12 VCT	6 VAC	4900-9012RF65	1-1672327-4
115/230 VAC	12.6 VCT	6.3 VAC	4900-9013RF65	1-1672327-5
115/230 VAC	24 VCT	12 VAC	4900-9024RF65	1-1672327-8
115/230 VAC	28 VCT	14 VAC	4900-9028RF65	1-1672327-9
115/230 VAC	48 VCT	24 VAC	4900-9048RF65	2-1672327-2

<small>THIS DRAWING IS A CONTROLLED DOCUMENT FOR TYCO ELECTRONICS CORPORATION IT IS SUBJECT TO CHANGE AND THE CONTROLLING ENGINEERING ORGANIZATION SHOULD BE CONTACTED FOR THE LATEST REVISION.</small>		DWN J. SLIKE 22APR2009 CHK J. HURLBURY 22APR2009 APVD J. HURLBURY 22APR2009	<b>Tyco Electronics</b> Tyco Electronics Harrisburg, PA 17105-3608
DIMENSIONS: INCHES [mm]	TOLERANCES UNLESS OTHERWISE SPECIFIED: 0 PLC ± 1 PLC ± 2 PLC ±.01 3 PLC ±.005 4 PLC ± ANGLES ± FINISH	NAME TRANSFORMER OUTLINE APPLICATION SPEC PRODUCT SPEC	SIZE A2 CAGE CODE 00779 DRAWING NO. 4900-RF65 RESTRICTED TO
MATERIAL		WEIGHT	CUSTOMER DRAWING
SCALE 1:1		SHEET 1 OF 1 REV D	

## **X-ON Electronics**

Largest Supplier of Electrical and Electronic Components

*Click to view similar products for [Power Transformers](#) category:*

*Click to view products by [TE Connectivity](#) manufacturer:*

Other Similar products are found below :

[ET-030A](#) [F-102X](#) [F-120X](#) [F-14X-1](#) [F-181U](#) [F-18A](#) [F-199U](#) [F-19X](#) [F-202U](#) [F-204U](#) [F-206U](#) [F-227X](#) [F-238U](#) [F-239U-1](#) [F-23U](#) [F24-250-B](#)  
[F-242U](#) [F-245U](#) [F-264U](#) [F-265U](#) [F-267U](#) [F-281U](#) [F-283U](#) [F-290X](#) [F-295Z](#) [F-296Z](#) [F-298Z](#) [F-3143P](#) [F-3298Z](#) [F-33U](#) [F-346X](#) [F-35U](#) [F-](#)  
[364U](#) [F-392A](#) [F-395X](#) [F-397U](#) [F-412X](#) [F-47U](#) [F-55X-1](#) [F-60U](#) [F-68U](#) [F-71U](#) [F-72Z](#) [F-74U](#) [F-83A](#) [F-84AC](#) [F-85U](#) [F-86U](#) [F-9U](#) [PCT-02](#)