

- 1 ASSEMBLY MAY BE BROKEN TO THE DESIRED NUMBER OF POSITIONS
- 2 TRUE POSITION TOLERANCE OF THE POST TIPS APPLIES WHEN THE HEADER IS HELD FLAT AGAINST THE PRINTED CIRCUIT BOARD
- 3 THE NOTED DIMENSIONS APPLY AT THE INTERSECTION OF THE POST AND HOUSING
- 4 POST PLATING: 0.00254-0.00508[.000100-.000200] MATTE TIN-LEAD OVER 0.00127[.000050] NICKEL ENTIRE POST.
- 5 HOUSING: LCP, COLOR-BLACK.
- 6 POST MATERIAL: COPPER ALLOY.
- 7 .000100-.000200 BRIGHT TIN OVER .000050 NICKEL ENTIRE POST.
- 8 POST PLATING: 0.00254-0.00508[.000100-.000200] MATTE TIN OVER 0.00127[.000050] NICKEL ENTIRE POST.
- 9 OBSOLETE PARTS: OBSOLETE CIS STREAMLINING PER D.RENAUD/D.SINISI

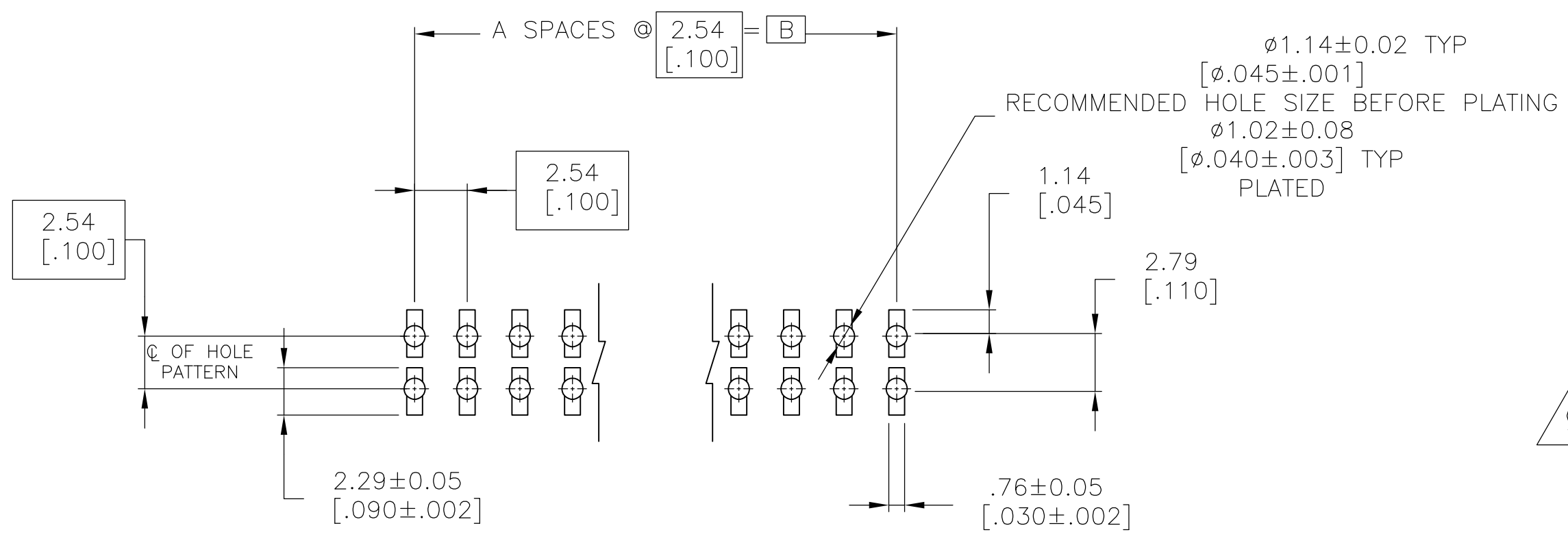
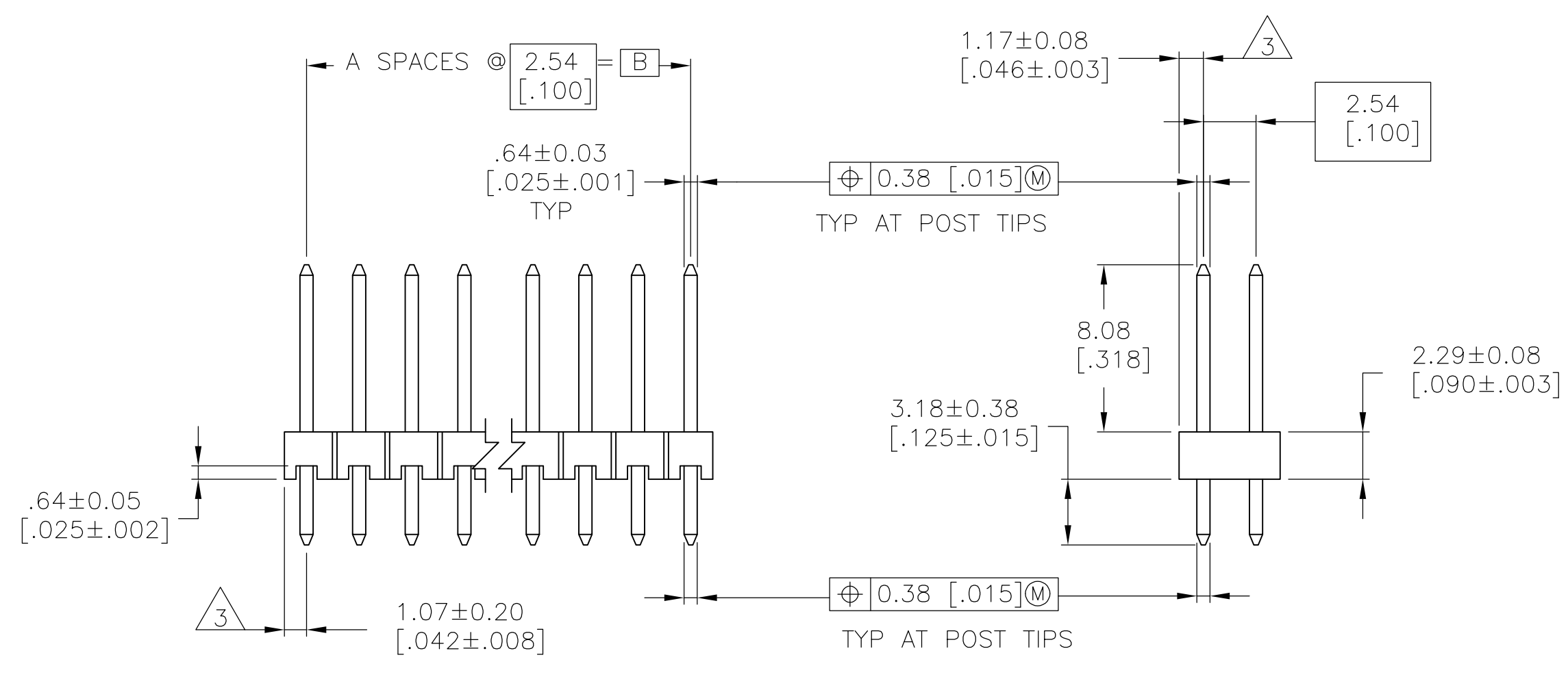
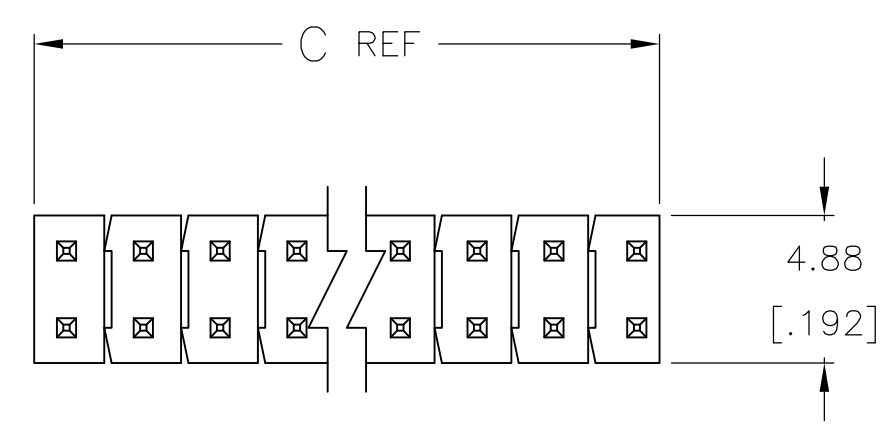

RECOMMENDED PC BOARD MOUNTING DIMENSIONS FOR .063 [1.60] THICK PC BOARD AND .012 [.305] STENCIL THICK.

PLATING	C	B	A	NO. OF POSITIONS	PART NUMBER
8	101.19 [3.984]	99.06 [3.900]	39	80	9-146250-0
8	98.65 [3.884]	96.52 [3.800]	38	78	8-146250-9
8	96.11 [3.784]	93.98 [3.700]	37	76	8-146250-8
8	93.57 [3.684]	91.44 [3.600]	36	74	8-146250-7
8	91.03 [3.584]	88.90 [3.500]	35	72	8-146250-6
8	88.49 [3.484]	86.36 [3.400]	34	70	8-146250-5
8	85.95 [3.384]	83.82 [3.300]	33	68	8-146250-4
8	83.41 [3.284]	81.28 [3.200]	32	66	8-146250-3
8	80.87 [3.184]	78.74 [3.100]	31	64	8-146250-2
8	78.33 [3.084]	76.20 [3.000]	30	62	8-146250-1
8	75.79 [2.984]	73.66 [2.900]	29	60	8-146250-0
8	73.25 [2.884]	71.12 [2.800]	28	58	7-146250-9
8	70.71 [2.784]	68.58 [2.700]	27	56	7-146250-8
8	68.17 [2.684]	66.04 [2.600]	26	54	7-146250-7
8	65.63 [2.584]	63.5 [2.500]	25	52	7-146250-6
8	63.09 [2.484]	60.96 [2.400]	24	50	7-146250-5
8	60.55 [2.384]	58.42 [2.300]	23	48	7-146250-4
8	58.01 [2.284]	55.88 [2.200]	22	46	7-146250-3
8	55.47 [2.184]	53.34 [2.100]	21	44	7-146250-2
8	52.93 [2.084]	50.80 [2.000]	20	42	7-146250-1
8	50.39 [1.984]	48.26 [1.900]	19	40	7-146250-0
8	47.85 [1.884]	45.72 [1.800]	18	38	6-146250-9
8	45.31 [1.784]	43.18 [1.700]	17	36	6-146250-8
8	42.77 [1.684]	40.64 [1.600]	16	34	6-146250-7
8	40.23 [1.584]	38.10 [1.500]	15	32	6-146250-6
8	37.69 [1.484]	35.56 [1.400]	14	30	6-146250-5
8	35.15 [1.384]	33.02 [1.300]	13	28	6-146250-4
8	32.61 [1.284]	30.48 [1.200]	12	26	6-146250-3
8	30.07 [1.184]	27.94 [1.100]	11	24	6-146250-2
8	27.53 [1.084]	25.40 [1.000]	10	22	6-146250-1
8	24.99 [0.984]	22.86 [0.900]	9	20	6-146250-0
8	22.45 [0.884]	20.32 [0.800]	8	18	5-146250-9
8	19.91 [0.784]	17.78 [0.700]	7	16	5-146250-8
8	17.37 [0.684]	15.24 [0.600]	6	14	5-146250-7
8	14.83 [0.584]	12.70 [0.500]	5	12	5-146250-6
8	12.29 [0.484]	10.16 [0.400]	4	10	5-146250-5
8	9.75 [0.384]	7.62 [0.300]	3	8	5-146250-4
8	7.21 [0.284]	5.08 [0.200]	2	6	5-146250-3
8	4.67 [0.184]	2.54 [0.100]	1	4	5-146250-2
8	-	-	0	2	5-146250-1

PLATING	C	B	A	NO. OF POSITIONS	PART NUMBER
4	101.19 [3.984]	99.06 [3.900]	39	80	4-146250-0
4	98.65 [3.884]	96.52 [3.800]	38	78	3-146250-9
4	96.11 [3.784]	93.98 [3.700]	37	76	3-146250-8
4	93.57 [3.684]	91.44 [3.600]	36	74	3-146250-7
4	91.03 [3.584]	88.90 [3.500]	35	72	3-146250-6
4	88.49 [3.484]	86.36 [3.400]	34	70	3-146250-5
4	85.95 [3.384]	83.82 [3.300]	33	68	3-146250-4
4	83.41 [3.284]	81.28 [3.200]	32	66	3-146250-3
4	80.87 [3.184]	78.74 [3.100]	31	64	3-146250-2
4	78.33 [3.084]	76.20 [3.000]	30	62	3-146250-1
4	75.79 [2.984]	73.66 [2.900]	29	60	3-146250-0
4	73.25 [2.884]	71.12 [2.800]	28	58	2-146250-9
4	70.71 [2.784]	68.58 [2.700]	27	56	2-146250-8
4	68.17 [2.684]	66.04 [2.600]	26	54	2-146250-7
4	65.63 [2.584]	63.5 [2.500]	25	52	2-146250-6
4	63.09 [2.484]	60.96 [2.400]	24	50	2-146250-5
4	60.55 [2.384]	58.42 [2.300]	23	48	2-146250-4
4	58.01 [2.284]	55.88 [2.200]	22	46	2-146250-3
4	55.47 [2.184]	53.34 [2.100]	21	44	2-146250-2
4	52.93 [2.084]	50.80 [2.000]	20	42	2-146250-1
4	50.39 [1.984]	48.26 [1.900]	19	40	2-146250-0
4	47.85 [1.884]	45.72 [1.800]	18	38	1-146250-9
4	45.31 [1.784]	43.18 [1.700]	17	36	1-146250-8
4	42.77 [1.684]	40.64 [1.600]	16	34	1-146250-7
4	40.23 [1.584]	38.10 [1.500]	15	32	1-146250-6
4	37.69 [1.484]	35.56 [1.400]	14	30	1-146250-5
4	35.15 [1.384]	33.02 [1.300]	13	28	1-146250-4
4	32.61 [1.284]	30.48 [1.200]	12	26	1-146250-3
4	30.07 [1.184]	27.94 [1.100]	11	24	1-146250-2
4	27.53 [1.084]	25.40 [1.000]	10	22	1-146250-1
4	24.99 [0.984]	22.86 [0.900]	9	20	1-146250-0
4	22.45 [0.884]	20.32 [0.800]	8	18	146250-9
4	19.91 [0.784]	17.78 [0.700]	7	16	146250-8
4	17.37 [0.684]	15.24 [0.600]	6	14	146250-7
4	14.83 [0.584]	12.70 [0.500]	5	12	146250-6
4	12.29 [0.484]	10.16 [0.400]	4	10	146250-5
4	9.75 [0.384]	7.62 [0.300]	3	8	146250-4
4	7.21 [0.284]	5.08 [0.200]	2	6	146250-3
4	4.67 [0.184]	2.54 [0.100]	1	4	146250-2
4	-	-	0	2	146250-1

THIS DRAWING IS A CONTROLLED DOCUMENT.

DIMENSIONS: mm [INCHES]	TOLERANCES UNLESS OTHERWISE SPECIFIED:	DIN I. HOFFMAN	BMAY95
0 PLC ± -	1 PLC ± 0.05 [0.2]	CHK G. DUBNICZKI	7JUN95
2 PLC ± 0.15 [0.005]	3 PLC ± 0.013 [0.005]	APVO G. DUBNICZKI	7JUN95
4 PLC ± -	ANGLES ± -	NAME	
MATERIAL	FINISH	WEIGHT	SIZE
SEE TABLE			CAGE CODE
			DRAWING NO
			RESTRICTED TO

STE TE Connectivity

HEADER ASSEMBLY, MOD II, BREAKAWAY, DOUBLE ROW, HIGH TEMPERATURE

00779C=146250

CUSTOMER DRAWING SCALE 4:1 SHEET 1 OF 1 REV K

X-ON Electronics

Largest Supplier of Electrical and Electronic Components

Click to view similar products for [Headers & Wire Housings](#) category:

Click to view products by [TE Connectivity](#) manufacturer:

Other Similar products are found below :

[892-18-020-10-001101](#) [58102-G61-06LF](#) [582553-1](#) [0009485154](#) [009176003701906](#) [0050291907](#) [LY20-4P-DT1-P1E-BR](#) [02.125.8002.8](#)
[609-3404](#) [61062-3](#) [61082-181009](#) [622-3653LF](#) [63453-116](#) [636-1030](#) [636-1427](#) [636-3427](#) [636-4007](#) [641938-9](#) [641991-4](#) [644827-2](#) [65817-010LF](#) [65817-015LF](#) [65863-015LF](#) [66207-023LF](#) [67095-007LF](#) [67601157](#) [68645-018](#) [68648-049](#) [70.362.1628.0](#) [70-4210](#) [70-4226B](#) [70-4853B](#) [707-5020](#) [707-5028](#) [71.350.2428.0](#) [71918-208LF](#) [71961-016LF](#) [733-134](#) [733-162](#) [754199-000](#) [760-3052](#) [787-8014-00](#) [79531-3000](#)
[FCN-360C032-B](#) [FCN-367T-T012/H](#) [FCN-723D010/2](#) [80.063.4001.1](#) [800-90-001-10-001000](#) [800-90-010-10-002000](#) [801-43-002-10-013000](#)