

| REVISIONS | | | | |
|-----------|-----|---------------------------|-----------|-------|
| P | LTR | DESCRIPTION | DATE | APPV |
| L | | REVISED PER ECO-20-001912 | 03JUN2020 | SB JO |

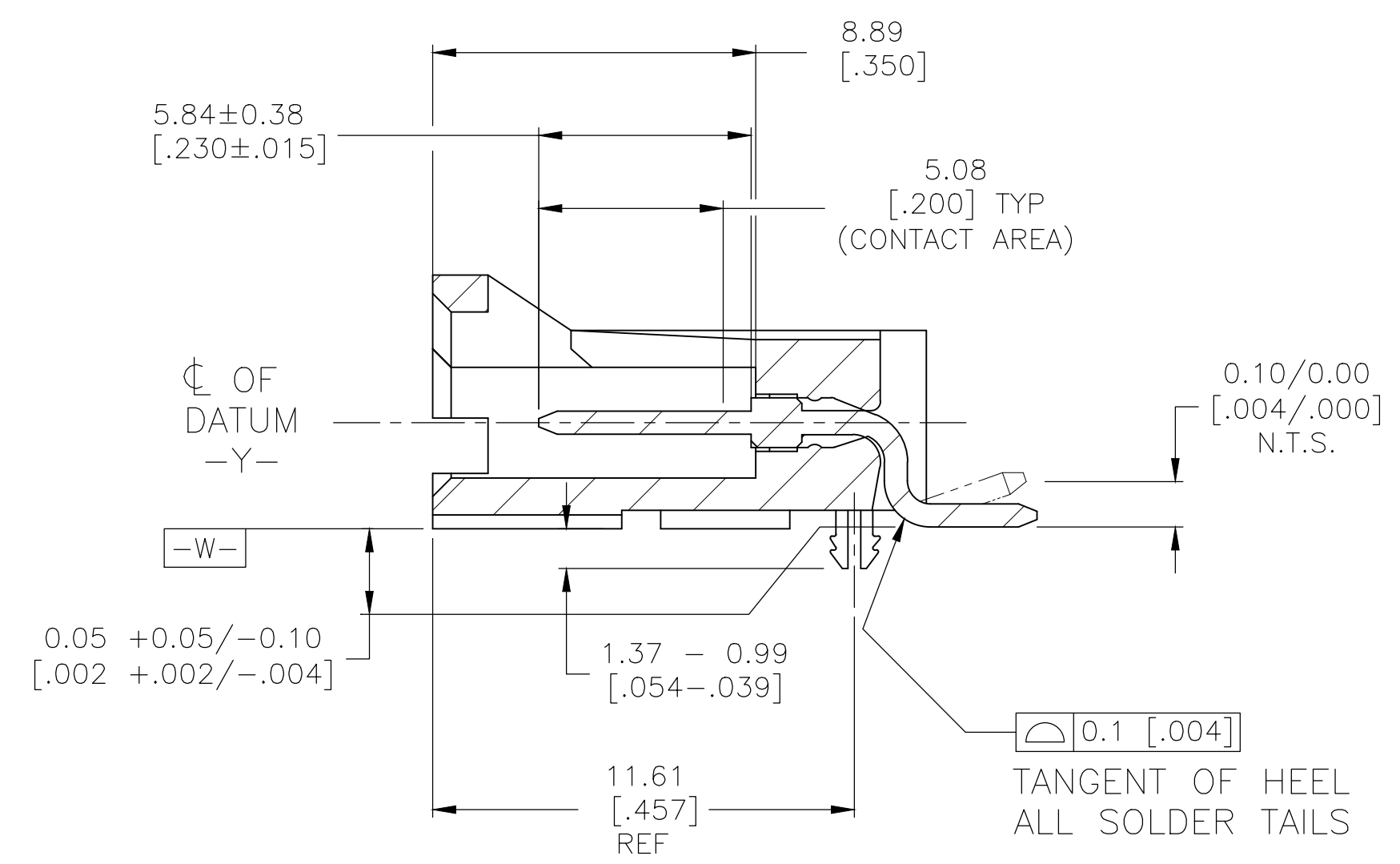

- 1 HOUSING: LCP, COLOR-BLACK.
POST: BRASS.
- 2 POST: 0.00254-0.00508 [.000100-.00200] BRIGHT TIN-LEAD OVER
0.00127-0.00254 [.000050-.000100] NICKEL.
- 3 DATUMS AND BASIC DIMENSIONS ESTABLISHED BY THE CUSTOMER.
- 4 TWO POLARIZATION SLOTS ON ASSEMBLIES WITH FOUR OR MORE
POSITIONS.
- 5 0.00254-0.00508 [.000100-.000200] BRIGHT TIN OVER
0.00127-0.00254 [.000050-.000100] NICKEL.
- 6 PRELIMINARY PART - NOT RELEASED FOR PRODUCTION.
- 7 0.00254-0.00508 [.000100-.000200] MATTE TIN OVER
0.00127-0.00254 [.000050-.000100] NICKEL.
- 8 0.25 [.010] RECESS PERMISSIBLE IN THIS AREA FOR MOLD SHUT OFF

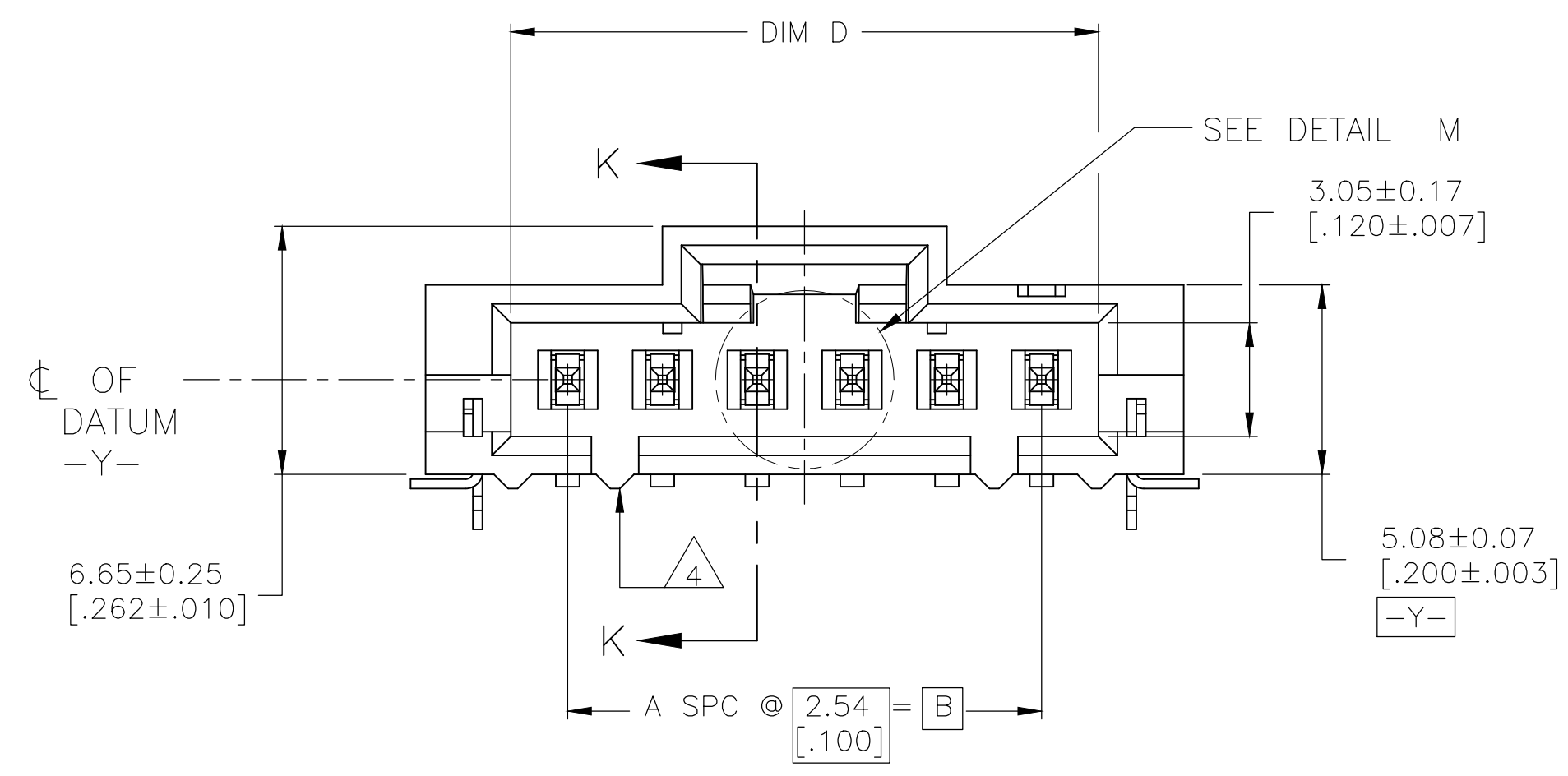
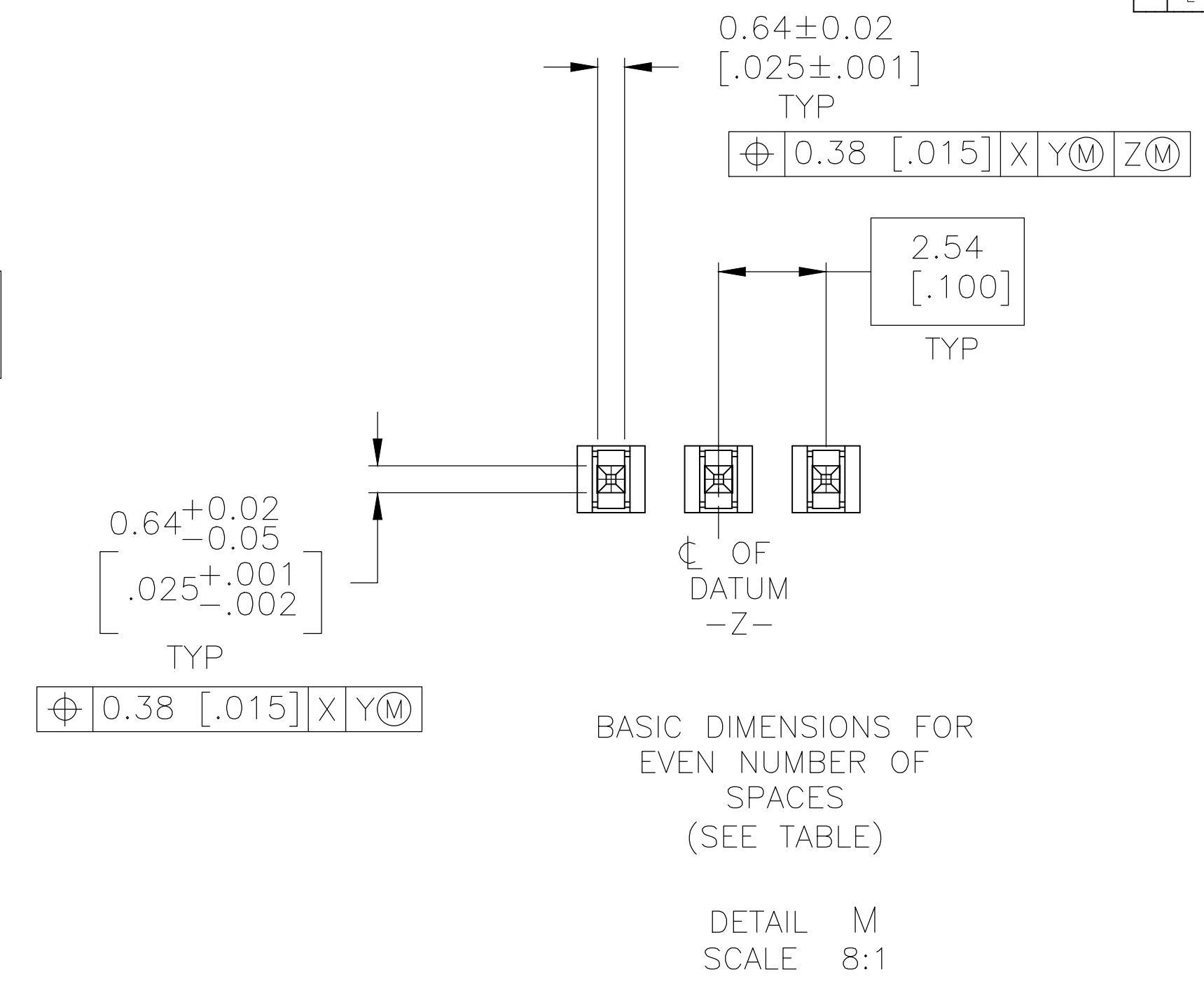
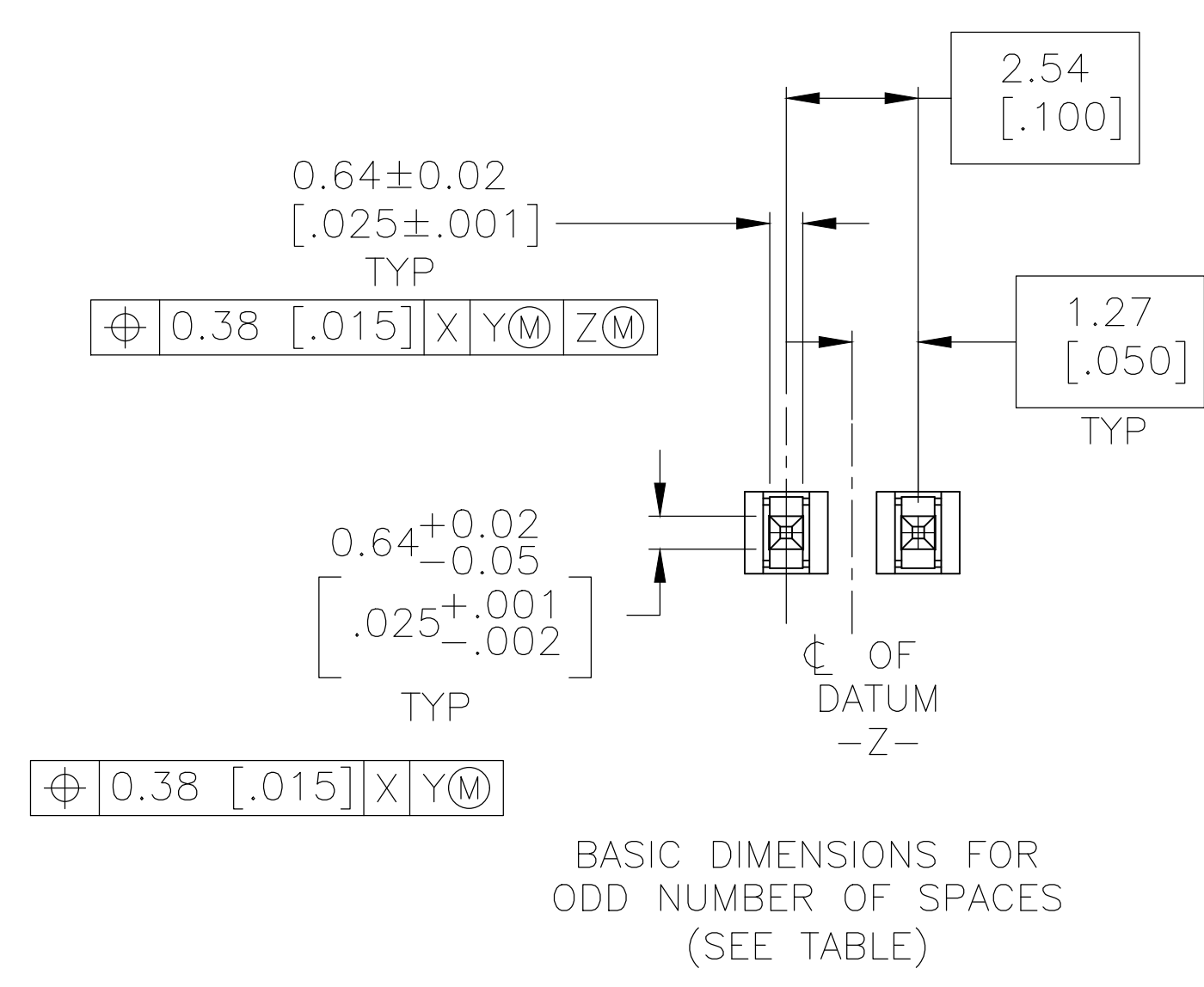
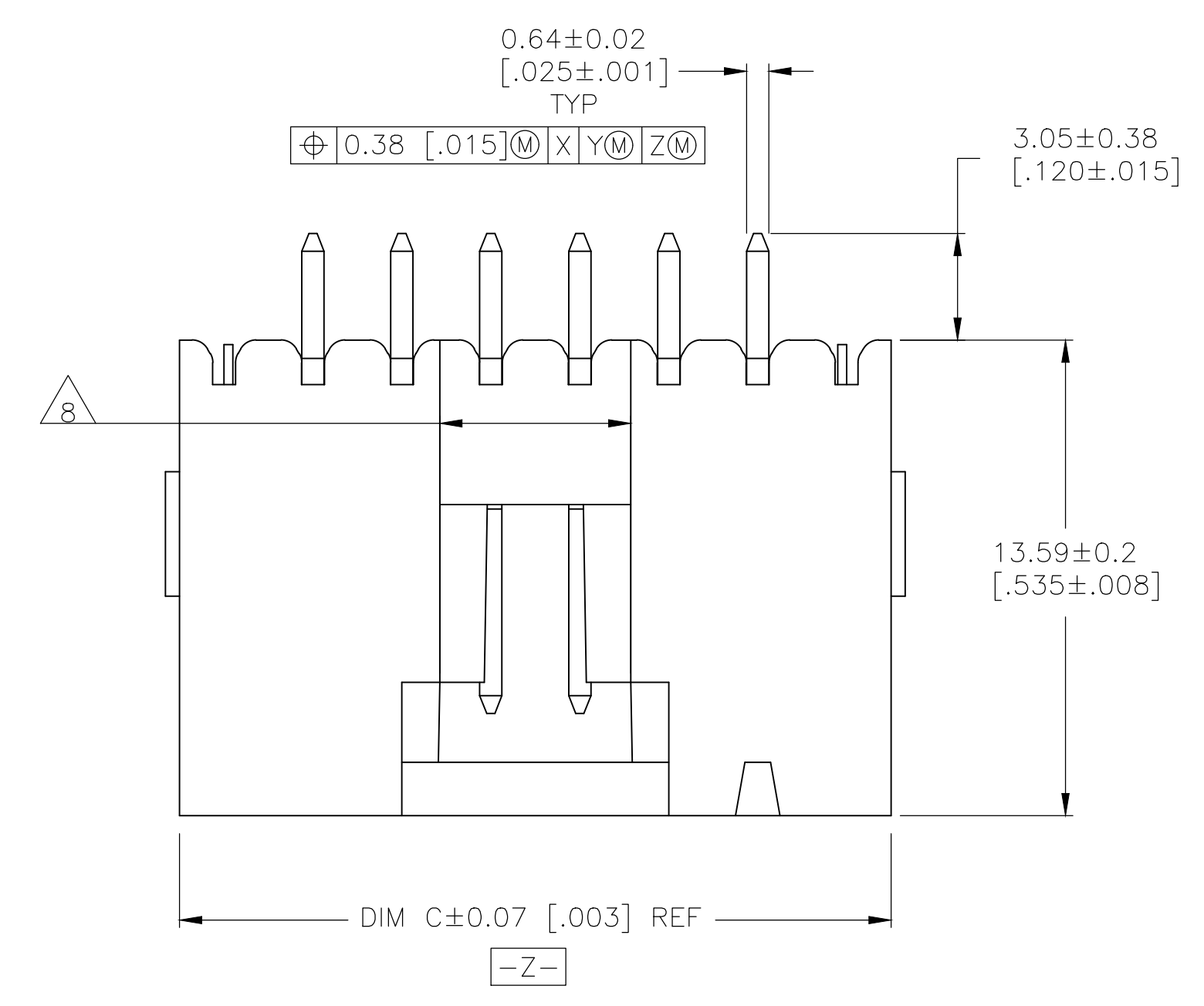
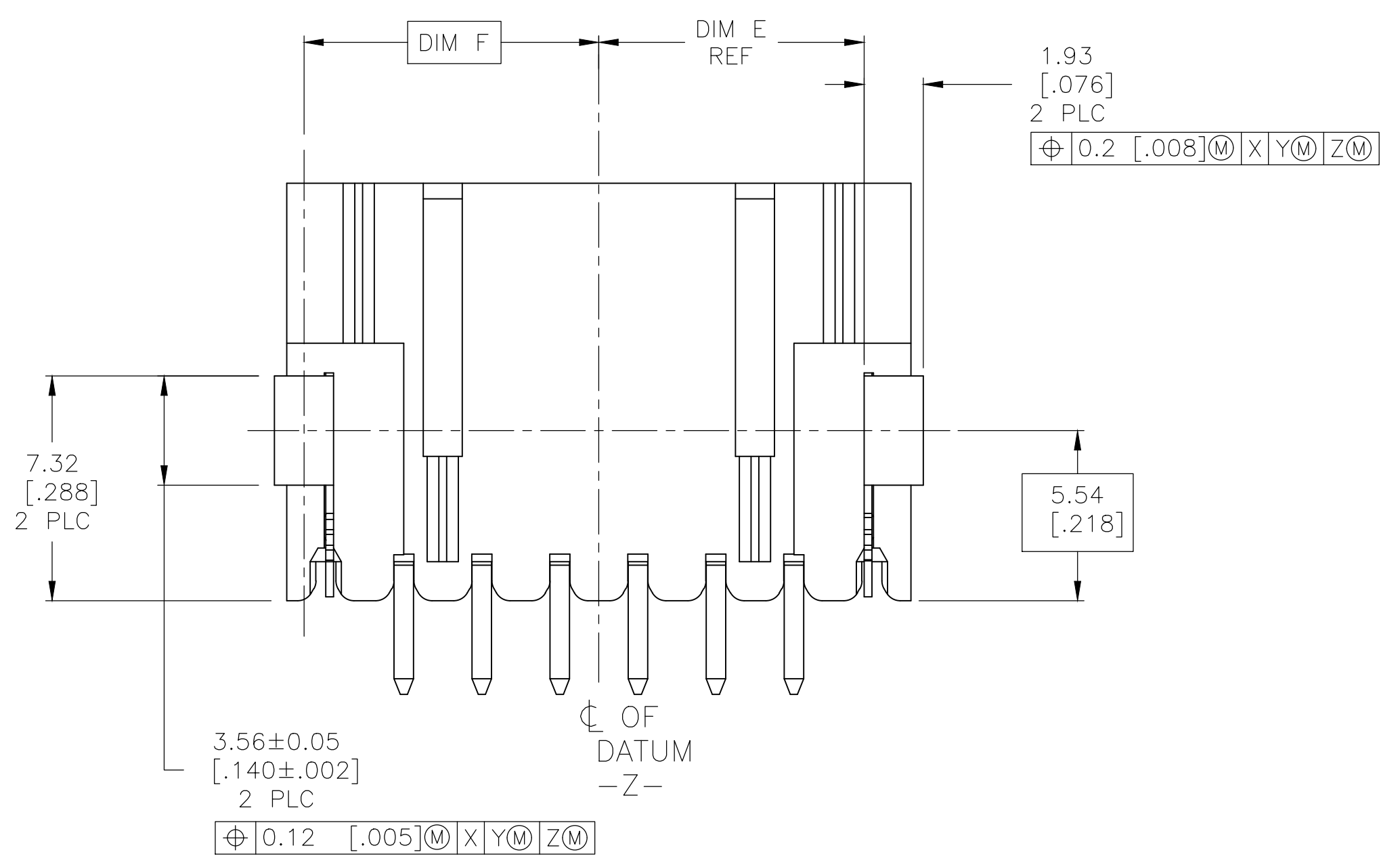

SEE TABLE ON
SHEET #3

| | | | |
|---|-----------|----------------------------|--|
| THIS DRAWING IS A CONTROLLED DOCUMENT. | | DIN B. HAYMAKER 02DEC99 | TE Connectivity Ltd. |
| DIMENSIONS: mm [INCHES] | | CHK J. MOSIER 02DEC99 | |
| TOLERANCES UNLESS OTHERWISE SPECIFIED: | | APPV J. MOSIER 02DEC99 | NAME |
| 0 PLC ± - | | | HEADER ASSEMBLY, LATCHING, RIGHT ANGLE SURFACE MOUNT, MTE, AMPMODU |
| 1 PLC ± - | | | PRODUCT SPEC |
| 2 PLC ± - | | | 108-25034 |
| 3 PLC ± 0.13 [.005] | | | APPLICATION SPEC |
| 4 PLC ± - | | | SIZE |
| ANGLES ± - | | | A1 |
| MATERIAL | FINISH | WEIGHT | SCALE |
| | SEE TABLE | 147324 | 6:1 |
| | | CUSTOMER DRAWING | SHEET 1 OF 4 |

| REVISIONS | | | | |
|-----------|-----|-------------|------|------|
| P | LTR | DESCRIPTION | DATE | APPV |
| - | - | SEE SHEET 1 | - | - |

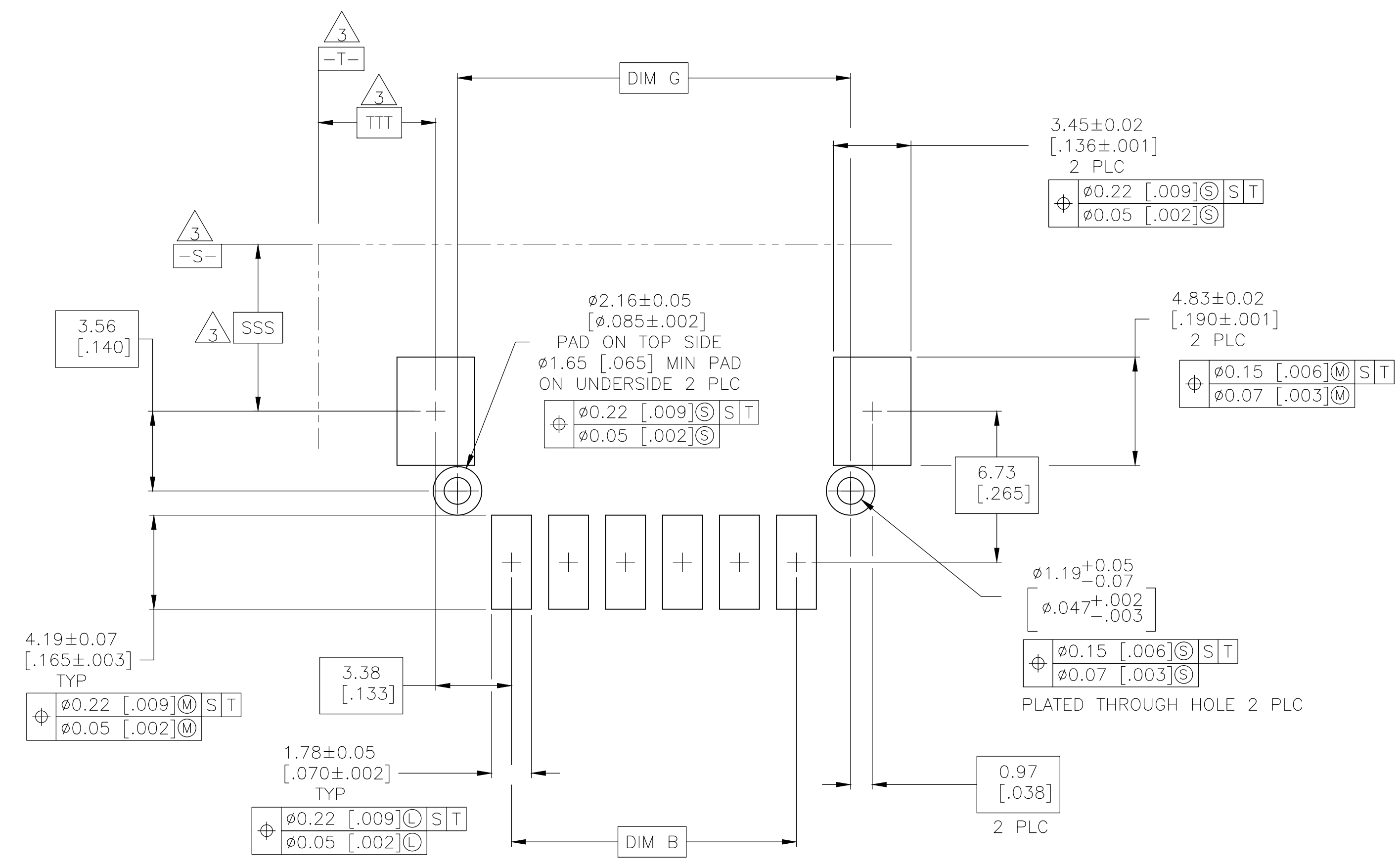

RECOMMENDED PC BOARD LAYOUT

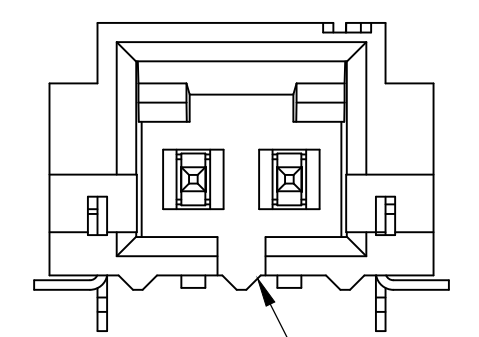

POLARIZATION SLOT FOR TWO POSITION

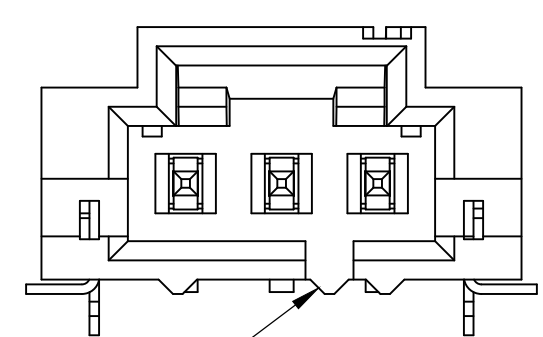

POLARIZING SLOT FOR THREE POSITION

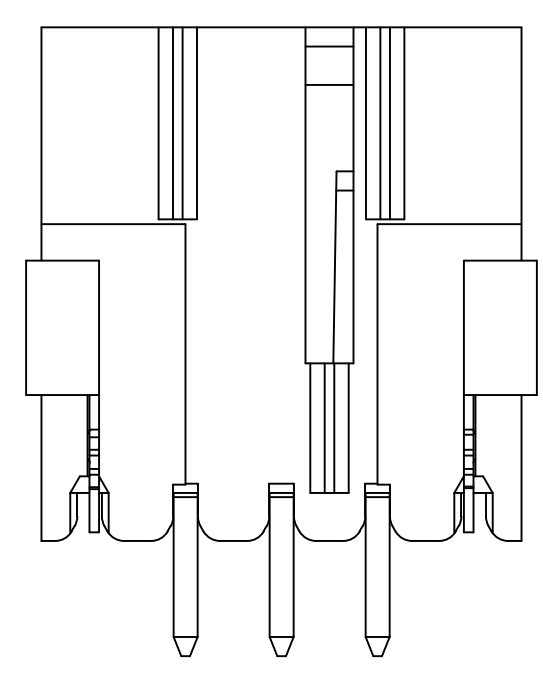
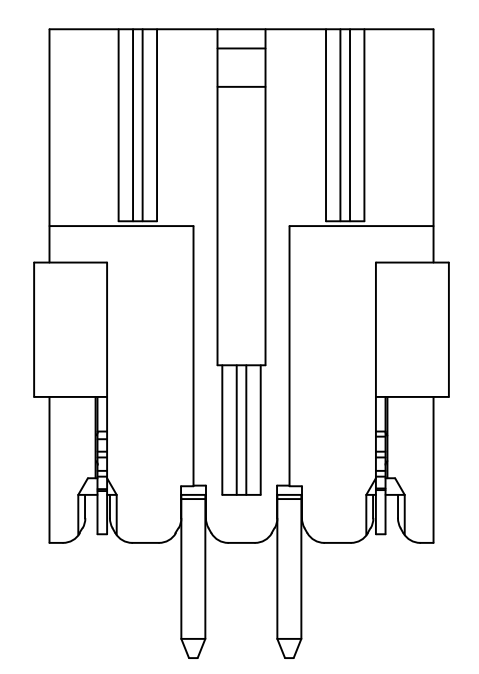

| | | | |
|--|---------------------|------------------------|--|
| THIS DRAWING IS A CONTROLLED DOCUMENT. | | DIN B HAYMAKER 02DEC99 | TE Connectivity Ltd. |
| DIMENSIONS: mm [INCHES] | | CHK J. MOSIER 02DEC99 | |
| TOLERANCES UNLESS OTHERWISE SPECIFIED: | | APPV J. MOSIER 02DEC99 | NAME |
| 0 PLC ± - | 1 PLC ± - | PRODUCT SPEC | HEADER ASSEMBLY, LATCHING, RIGHT ANGLE SURFACE MOUNT, MTE, AMPMODU |
| 2 PLC ± - | 3 PLC ± 0.13 [.005] | APPLICATION SPEC | 108-25034 |
| 4 PLC ± - | ANGLES ± - | SIZE | A1 |
| MATERIAL | FINISH SEE TABLE | WEIGHT | 00779 C=147324 |
| CUSTOMER DRAWING | | SCALE | 6:1 |
| | | SHEET | 2 OF 4 |
| | | REV | L |

| REVISIONS | | | | |
|-----------|-----|-------------|------|------|
| P | LTR | DESCRIPTION | DATE | APVD |
| - | | SEE SHEET 1 | - | - |

| | | | | | | | | | | |
|---------|-----------------------|---------------|---------------|---------------|---------------|---------------|---------------|----|------------|-------------|
| △5 | 44 | 17.53 [.690] | 9.60 [.378] | 8.64 [.340] | 15.75 [.620] | 20.19 [.795] | 12.70 [.500] | 5 | 6 | 2-147324-7 |
| △5 | 44 | 27.69 [1.090] | 14.68 [.578] | 13.72 [.540] | 25.91 [1.020] | 30.35 [1.195] | 22.86 [.900] | 9 | 10 | 2-147324-6 |
| △5 | 24 | 7.37 [.290] | 4.52 [.178] | 3.56 [.140] | 5.59 [.220] | 10.03 [.395] | 2.54 [.100] | 1 | 2 | 2-147324-5 |
| △2 | 88 | 65.79 [2.590] | 33.73 [1.328] | 32.77 [1.290] | 64.01 [2.520] | 68.45 [2.695] | 60.96 [2.400] | 24 | 25 | 2-147324-4 |
| △2 | 88 | 63.25 [2.490] | 32.46 [1.278] | 31.50 [1.240] | 61.47 [2.420] | 65.91 [2.595] | 58.42 [2.300] | 23 | 24 | 2-147324-3 |
| △2 | 88 | 60.71 [2.390] | 31.19 [1.228] | 30.23 [1.190] | 58.93 [2.320] | 63.37 [2.495] | 55.88 [2.200] | 22 | 23 | 2-147324-2 |
| △2 | 88 | 58.17 [2.290] | 29.92 [1.178] | 28.96 [1.140] | 56.39 [2.220] | 60.83 [2.395] | 53.34 [2.100] | 21 | 22 | 2-147324-1 |
| △2 | 88 | 55.63 [2.190] | 28.65 [1.128] | 27.69 [1.090] | 53.85 [2.120] | 58.29 [2.295] | 50.80 [2.000] | 20 | 21 | 2-147324-0 |
| △2 | 72 | 53.09 [2.090] | 27.38 [1.078] | 26.42 [1.040] | 51.31 [2.020] | 55.75 [2.195] | 48.26 [1.900] | 19 | 20 | 1-147324-9 |
| △2 | 72 | 50.55 [1.990] | 26.11 [1.028] | 25.15 [.990] | 48.77 [1.920] | 53.21 [2.095] | 45.72 [1.800] | 18 | 19 | 1-147324-8 |
| △2 | 72 | 48.01 [1.890] | 24.84 [.978] | 23.88 [.940] | 46.23 [1.820] | 50.67 [1.995] | 43.18 [1.700] | 17 | 18 | 1-147324-7 |
| △2 | 72 | 45.47 [1.790] | 23.57 [.928] | 22.61 [.890] | 43.69 [1.720] | 48.13 [1.895] | 40.64 [1.600] | 16 | 17 | 1-147324-6 |
| △2 | 72 | 42.93 [1.690] | 22.30 [.878] | 21.34 [.840] | 41.15 [1.620] | 45.59 [1.795] | 38.10 [1.500] | 15 | 16 | 1-147324-5 |
| △2 | 72 | 40.39 [1.590] | 21.03 [.828] | 20.07 [.790] | 38.61 [1.520] | 43.05 [1.695] | 35.56 [1.400] | 14 | 15 | 1-147324-4 |
| △2 | 56 | 37.85 [1.490] | 19.76 [.778] | 18.80 [.740] | 36.07 [1.420] | 40.51 [1.595] | 33.02 [1.300] | 13 | 14 | 1-147324-3 |
| △2 | 56 | 35.31 [1.390] | 18.49 [.728] | 17.53 [.690] | 33.53 [1.320] | 37.97 [1.495] | 30.48 [1.200] | 12 | 13 | 1-147324-2 |
| △2 | 56 | 32.77 [1.290] | 17.22 [.678] | 16.26 [.640] | 30.99 [1.220] | 35.43 [1.395] | 27.94 [1.100] | 11 | 12 | 1-147324-1 |
| △2 | 56 | 30.23 [1.190] | 15.95 [.628] | 14.99 [.590] | 28.45 [1.120] | 32.89 [1.295] | 25.40 [1.000] | 10 | 11 | 1-147324-0 |
| △2 | 44 | 27.69 [1.090] | 14.68 [.578] | 13.72 [.540] | 25.91 [1.020] | 30.35 [1.195] | 22.86 [.900] | 9 | 10 | 147324-9 |
| △2 | 44 | 25.15 [.990] | 13.41 [.528] | 12.45 [.490] | 23.37 [.920] | 27.81 [1.095] | 20.32 [.800] | 8 | 9 | 147324-8 |
| △2 | 44 | 22.61 [.890] | 12.14 [.478] | 11.18 [.440] | 20.83 [.820] | 25.27 [.995] | 17.78 [.700] | 7 | 8 | 147324-7 |
| △2 | 44 | 20.07 [.790] | 10.87 [.428] | 9.91 [.390] | 18.29 [.720] | 22.73 [.895] | 15.24 [.600] | 6 | 7 | 147324-6 |
| △2 | 44 | 17.53 [.690] | 9.60 [.378] | 8.64 [.340] | 15.75 [.620] | 20.19 [.795] | 12.70 [.500] | 5 | 6 | 147324-5 |
| △2 | 32 | 14.99 [.590] | 8.33 [.328] | 7.37 [.290] | 13.21 [.520] | 17.65 [.695] | 10.16 [.400] | 4 | 5 | 147324-4 |
| △2 | 24 | 12.45 [.490] | 7.06 [.278] | 6.10 [.240] | 10.67 [.420] | 15.11 [.595] | 7.62 [.300] | 3 | 4 | 147324-3 |
| △2 | 24 | 9.91 [.390] | 5.79 [.228] | 4.83 [.190] | 8.13 [.320] | 12.57 [.495] | 5.08 [.200] | 2 | 3 | 147324-2 |
| △2 | 24 | 7.37 [.290] | 4.52 [.178] | 3.56 [.140] | 5.59 [.220] | 10.03 [.395] | 2.54 [.100] | 1 | 2 | 147324-1 |
| PLATING | EIA 481 TAPE WIDTH mm | G | F | E | D | C | B | A | NO OF POSN | PART NUMBER |

THIS DRAWING IS A CONTROLLED DOCUMENT.

| | | | |
|----------------------------|--|--|--------------------------|
| DIMENSIONS: mm [INCHES] | TOLERANCES UNLESS OTHERWISE SPECIFIED: 0. PLC ± - 1. PLC ± - 2. PLC ± - 3. PLC ± 0.13 [.005] 4. PLC ± - ANGLES ± - | DIN B HAYMAKER 02DEC99 CIK 02DEC99 APVD J. MOSIER 02DEC99 | STE TE Connectivity Ltd. |
| | SEE TABLE | NAME HEADER ASSEMBLY, LATCHING, RIGHT ANGLE SURFACE MOUNT, MTE, AMPMODU | RESTRICTED TO |
| MATERIAL △1 | FINISH | SIZE CASE CODE DRAWING NO A1 00779 147324 | WEIGHT |
| CUSTOMER DRAWING | | SCALE 1:1 | SHEET 3 OF 4 REV L |

| REVISIONS | | | | |
|-----------|-----|-------------|------|------|
| P | LTR | DESCRIPTION | DATE | APPD |
| - | | SEE SHEET 1 | - | - |

| | | | | | | | | | | |
|---------|-----------------------|---------------|---------------|---------------|---------------|---------------|---------------|----|------------|-------------|
| | 88 | 65.79 [2.590] | 33.73 [1.328] | 32.77 [1.290] | 64.01 [2.520] | 68.45 [2.695] | 60.96 [2.400] | 24 | 25 | 7-147324-4 |
| | 88 | 63.25 [2.490] | 32.46 [1.278] | 31.50 [1.240] | 61.47 [2.420] | 65.91 [2.595] | 58.42 [2.300] | 23 | 24 | 7-147324-3 |
| | 88 | 60.71 [2.390] | 31.19 [1.228] | 30.23 [1.190] | 58.93 [2.320] | 63.37 [2.495] | 55.88 [2.200] | 22 | 23 | 7-147324-2 |
| | 88 | 58.17 [2.290] | 29.92 [1.178] | 28.96 [1.140] | 56.39 [2.220] | 60.83 [2.395] | 53.34 [2.100] | 21 | 22 | 7-147324-1 |
| | 88 | 55.63 [2.190] | 28.65 [1.128] | 27.69 [1.090] | 53.85 [2.120] | 58.29 [2.295] | 50.80 [2.000] | 20 | 21 | 7-147324-0 |
| | 72 | 53.09 [2.090] | 27.38 [1.078] | 26.42 [1.040] | 51.31 [2.020] | 55.75 [2.195] | 48.26 [1.900] | 19 | 20 | 6-147324-9 |
| | 72 | 50.55 [1.990] | 26.11 [1.028] | 25.15 [.990] | 48.77 [1.920] | 53.21 [2.095] | 45.72 [1.800] | 18 | 19 | 6-147324-8 |
| | 72 | 48.01 [1.890] | 24.84 [.978] | 23.88 [.940] | 46.23 [1.820] | 50.67 [1.995] | 43.18 [1.700] | 17 | 18 | 6-147324-7 |
| | 72 | 45.47 [1.790] | 23.57 [.928] | 22.61 [.890] | 43.69 [1.720] | 48.13 [1.895] | 40.64 [1.600] | 16 | 17 | 6-147324-6 |
| | 72 | 42.93 [1.690] | 22.30 [.878] | 21.34 [.840] | 41.15 [1.620] | 45.59 [1.795] | 38.10 [1.500] | 15 | 16 | 6-147324-5 |
| | 72 | 40.39 [1.590] | 21.03 [.828] | 20.07 [.790] | 38.61 [1.520] | 43.05 [1.695] | 35.56 [1.400] | 14 | 15 | 6-147324-4 |
| | 56 | 37.85 [1.490] | 19.76 [.778] | 18.80 [.740] | 36.07 [1.420] | 40.51 [1.595] | 33.02 [1.300] | 13 | 14 | 6-147324-3 |
| | 56 | 35.31 [1.390] | 18.49 [.728] | 17.53 [.690] | 33.53 [1.320] | 37.97 [1.495] | 30.48 [1.200] | 12 | 13 | 6-147324-2 |
| | 56 | 32.77 [1.290] | 17.22 [.678] | 16.26 [.640] | 30.99 [1.220] | 35.43 [1.395] | 27.94 [1.100] | 11 | 12 | 6-147324-1 |
| | 56 | 30.23 [1.190] | 15.95 [.628] | 14.99 [.590] | 28.45 [1.120] | 32.89 [1.295] | 25.40 [1.000] | 10 | 11 | 6-147324-0 |
| | 44 | 27.69 [1.090] | 14.68 [.578] | 13.72 [.540] | 25.91 [1.020] | 30.35 [1.195] | 22.86 [.900] | 9 | 10 | 5-147324-9 |
| | 44 | 25.15 [.990] | 13.41 [.528] | 12.45 [.490] | 23.37 [.920] | 27.81 [1.095] | 20.32 [.800] | 8 | 9 | 5-147324-8 |
| | 44 | 22.61 [.890] | 12.14 [.478] | 11.18 [.440] | 20.83 [.820] | 25.27 [.995] | 17.78 [.700] | 7 | 8 | 5-147324-7 |
| | 44 | 20.07 [.790] | 10.87 [.428] | 9.91 [.390] | 18.29 [.720] | 22.73 [.895] | 15.24 [.600] | 6 | 7 | 5-147324-6 |
| | 44 | 17.53 [.690] | 9.60 [.378] | 8.64 [.340] | 15.75 [.620] | 20.19 [.795] | 12.70 [.500] | 5 | 6 | 5-147324-5 |
| | 32 | 14.99 [.590] | 8.33 [.328] | 7.37 [.290] | 13.21 [.520] | 17.65 [.695] | 10.16 [.400] | 4 | 5 | 5-147324-4 |
| | 24 | 12.45 [.490] | 7.06 [.278] | 6.10 [.240] | 10.67 [.420] | 15.11 [.595] | 7.62 [.300] | 3 | 4 | 5-147324-3 |
| | 24 | 9.91 [.390] | 5.79 [.228] | 4.83 [.190] | 8.13 [.320] | 12.57 [.495] | 5.08 [.200] | 2 | 3 | 5-147324-2 |
| | 24 | 7.37 [.290] | 4.52 [.178] | 3.56 [.140] | 5.59 [.220] | 10.03 [.395] | 2.54 [.100] | 1 | 2 | 5-147324-1 |
| PLATING | EIA 481 TAPE WIDTH mm | G | F | E | D | C | B | A | NO OF POSN | PART NUMBER |

THIS DRAWING IS A CONTROLLED DOCUMENT.

| | | | |
|----------------------------|--|---|--|
| DIMENSIONS: mm [INCHES] | TOLERANCES UNLESS OTHERWISE SPECIFIED: 0. PLC ± - 1. PLC ± - 2. PLC ± - 3. PLC ± 0.13 [.005] 4. PLC ± - ANGLES ± - | DIN B HAYMAKER 02DEC99 CIK J MOSIER 02DEC99 APVD J MOSIER 02DEC99 | NAME HEADER ASSEMBLY, LATCHING, RIGHT ANGLE SURFACE MOUNT, MTE, AMPMODU |
| | SEE TABLE | SIZE A1 WEIGHT - CUSTOMER DRAWING | RESTRICTED TO - SCALE 1:1 SHEET 4 OF 4 REV L |

4805 (1/15)

X-ON Electronics

Largest Supplier of Electrical and Electronic Components

Click to view similar products for [Headers & Wire Housings](#) category:

Click to view products by [TE Connectivity](#) manufacturer:

Other Similar products are found below :

[892-18-020-10-001101](#) [58102-G61-06LF](#) [582553-1](#) [0009485154](#) [009176003701906](#) [0050291907](#) [LY20-4P-DT1-P1E-BR](#) [02.125.8002.8](#)
[609-3404](#) [61062-3](#) [61082-181009](#) [622-3653LF](#) [63453-116](#) [636-1030](#) [636-1427](#) [636-3427](#) [636-4007](#) [641938-9](#) [641991-4](#) [644827-2](#) [65817-](#)
[010LF](#) [65817-015LF](#) [65863-015LF](#) [66207-023LF](#) [67095-007LF](#) [67601157](#) [68645-018](#) [68648-049](#) [70.362.1628.0](#) [70-4210](#) [70-4226B](#) [70-](#)
[4853B](#) [707-5020](#) [707-5028](#) [71.350.2428.0](#) [71918-208LF](#) [71961-016LF](#) [733-134](#) [733-162](#) [754199-000](#) [760-3052](#) [79531-3000](#) [FCN-](#)
[360C032-B](#) [FCN-367T-T012/H](#) [FCN-723D010/2](#) [80.063.4001.1](#) [800-90-010-10-002000](#) [801-43-002-10-013000](#) [801-43-006-10-002000](#)
[801-93-011-10-001000](#)