

THIS DRAWING IS UNPUBLISHED.

RELEASED FOR PUBLICATION JUNE ,2004.

REVISIONS

© COPYRIGHT 2004 By -

ALL RIGHTS RESERVED.

P	LTR	DESCRIPTION	DATE	DWN	APVD
	F	ecr-19-011875	09AUG2019	RZ	RS

NOTES

- 1 SINGLE PACK IN ACCORDANCE WITH TE SPEC 107-3275
- 2 100 TRAY PACK IN ACCORDANCE WITH TE SPEC 107-3275
- 3 Au PLATING
- 4. FOR TECHNICAL DATA REFER TO YOUR LOCAL TE CONNECTIVITY SALES OFFICE
- 5. ALL DIMENSIONS ARE NOMINAL FOR REFERENCE ONLY UNLESS OTHERWISE STATED
- 6. PACKAGING, 350/REEL X 4 = 1400 PER BOX

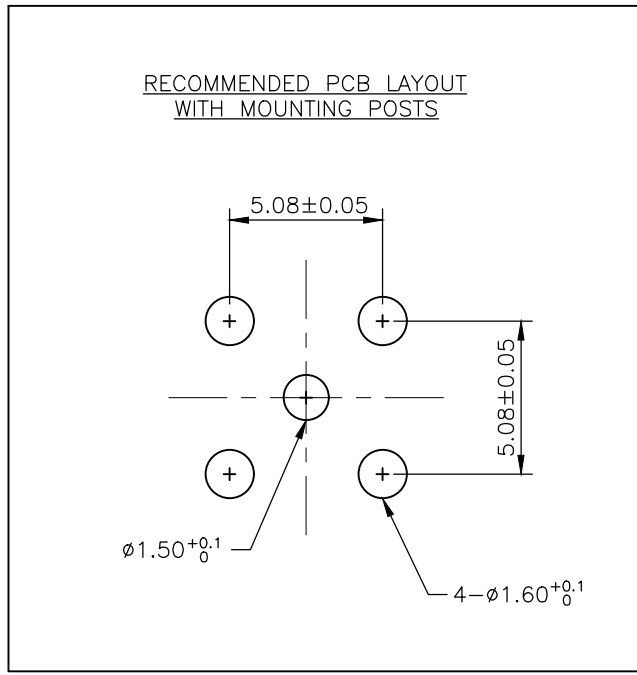
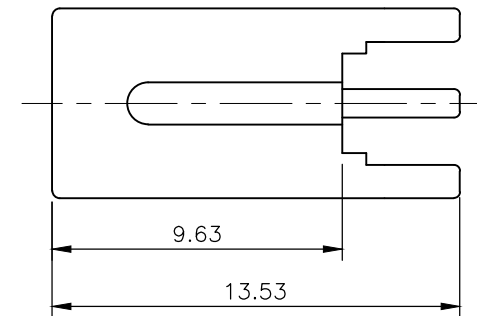
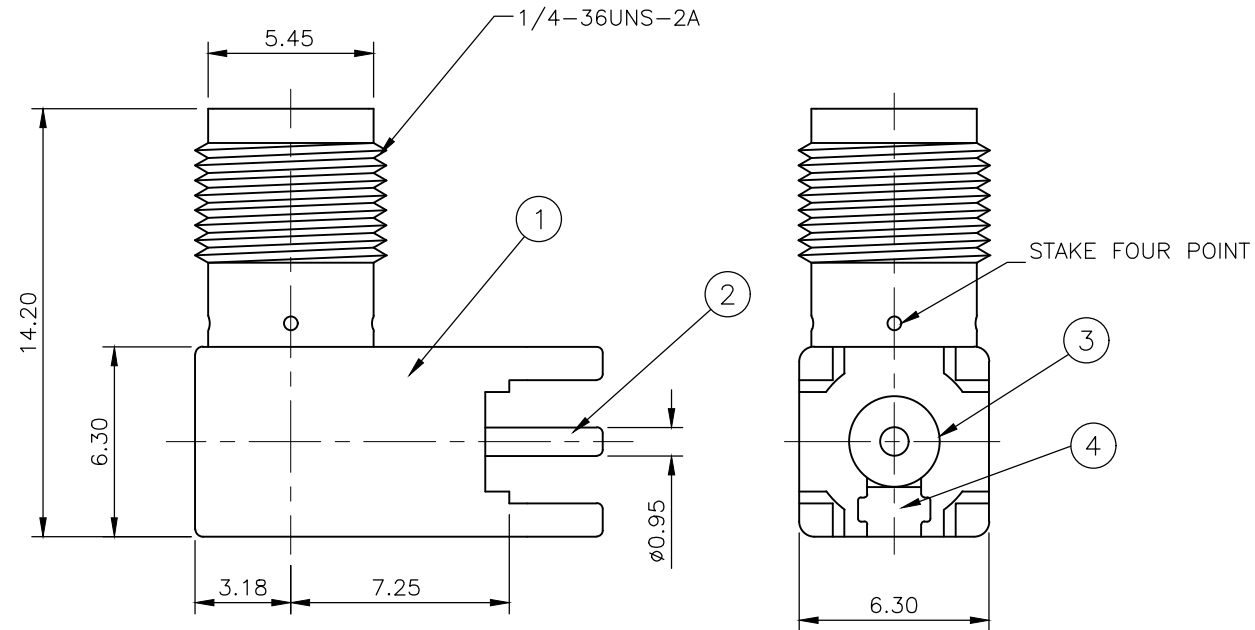

QTY	DESCRIPTION	ITEM
1	ZINC ALLOY	3 CAP
1	PTFE	INSULATOR
1	BERYLLIUM COPPER	CONTACT
1	ZINC ALLOY	BODY
5--25--15--0	MATERIAL	DESCRIPTION
6		
1		
1		

QUANTITY PER ASSY

PARTS LIST

THIS DRAWING IS A CONTROLLED DOCUMENT.

DWN ANSON MA 17MAR09
 CHK RITA ZUO 17MAR09
 APVD BOB ZHAO 17MAR09

PRODUCT SPEC 108-112000
 APPLICATION SPEC -

WEIGHT 0.000000

CUSTOMER DRAWING

STE TE Connectivity

NAME SMA RIGHT ANGLE PCB SOCKET DIE CAST

SIZE A3 CAGE CODE 00779 DRAWING NO C-1814400 RESTRICTED TO -

SCALE NTS SHEET 1 OF 2 REV F

THIS DRAWING IS UNPUBLISHED.

RELEASED FOR PUBLICATION JUNE , 2004.

© COPYRIGHT 2004 By -

ALL RIGHTS RESERVED.

REVISIONS

P	LTR	DESCRIPTION	DATE	DWN	APVD
-	-	SEE SHEET 1	-	-	-

FEED DIRECTION

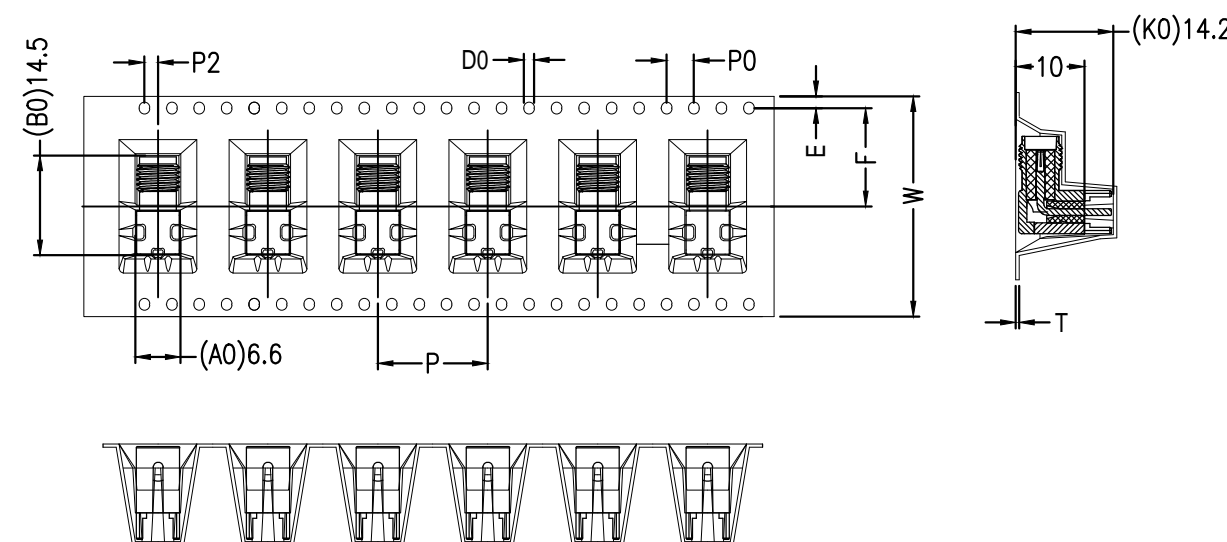
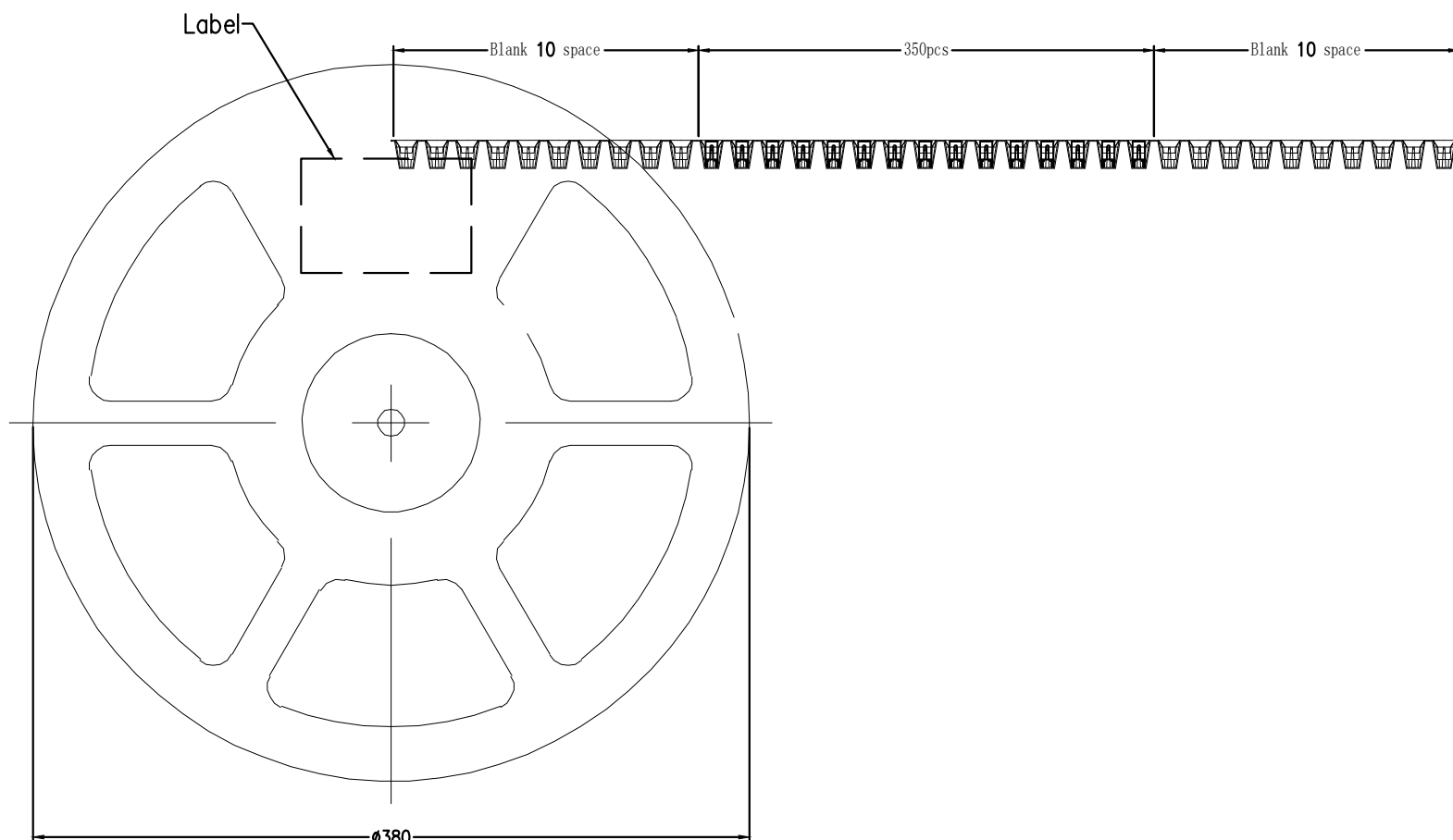
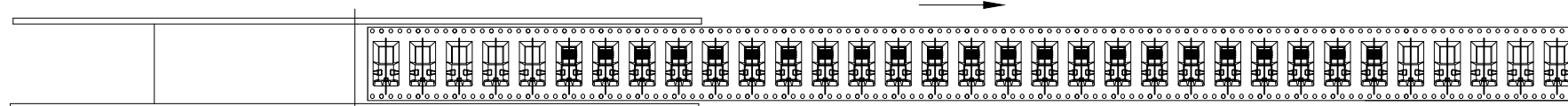

symbol	AO	BO	KO	PO	P	P2
Spec	6.60±0.10	14.5±0.10	14.20±0.10	4.00±0.10	16.0±0.10	2.00±0.10
symbol	W	T	E	F	DO	
Spec	32.0±0.30	0.50±0.05	1.75±0.10	14.2±0.10	1.50±0.10	

THIS DRAWING IS A CONTROLLED DOCUMENT.

DWN ANSON MA 17MAR09

CHK RITA ZUO 17MAR09

APVD BOB ZHAO 17MAR09

PRODUCT SPEC

108-112000

APPLICATION SPEC

WEIGHT 0.000000

CUSTOMER DRAWING

STE TE Connectivity

NAME SMA RIGHT ANGLE PCB SOCKET DIE CAST

SIZE CAGE CODE DRAWING NO RESTRICTED TO

A3 00779 C-1814400

SCALE NTS SHEET 2 OF 2 REV F

DIMENSIONS:

mm

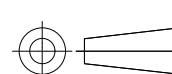

TOLERANCES UNLESS OTHERWISE SPECIFIED:

0 PLC	± 0.5
1 PLC	± 0.3
2 PLC	± 0.2
3 PLC	± -
4 PLC	± -
ANGLES	± -

MATERIAL

SEE TABLE

FINISH

-

X-ON Electronics

Largest Supplier of Electrical and Electronic Components

Click to view similar products for [RF Connectors / Coaxial Connectors](#) category:

Click to view products by [TE Connectivity](#) manufacturer:

Other Similar products are found below :

[8915-1511-000](#) [89674-0827](#) [6001-7071-019](#) [6002-7051-003](#) [6002-7551-202](#) [6059674-1](#) [619550-1](#) [630059-000](#) [M39030/3-01N](#) [6500-7071-046](#) [6769](#) [CX050L2AQ](#) [7002-1541-010](#) [7002-1542-011](#) [7004-1512-000](#) [7009-1511-004](#) [7010-1511-000](#) [7029-1511-060](#) [7101-1541-010](#) [7101-1571-002](#) [7105-1521-002](#) [7145-1521-002](#) [7203-1571-003](#) [7209-1511-011](#) [7210-1511-015](#) [7210-1511-019](#) [73137-5015](#) [73216-2241](#) [73404-2300](#) [7405-1521-005](#) [7405-1521-802](#) [8527](#) [8547](#) [FS11V](#) [877931](#) [8808-1511-001](#) [9074-9513-000](#) [9101-9573-002](#) [910A205F](#) [9130-9573-002](#) [PL11SC-026](#) [PL375-33](#) [PL40-5](#) [PL74C-221](#) [PL75MC-217](#) [PL803-7](#) [1200690078](#) [1-201144-1](#) [R107003010W](#) [R110A172100](#)