

LOC	DIST	REVISIONS					
		P	LTR	DESCRIPTION	DATE	DWN	APVD
E	B		D	ECO-13-012122	13NOV2013	RZ	MY
		1.1	9-1478242-0	RG58C/U, 141A/U, 303/U, URM43, 76, BELDEN 9907, KX15	5-1814802-3		
		1.1	9-1478242-0	RG58C/U, 141A/U, 303/U, URM43, 76, BELDEN 9907, KX15	5-1814802-2		
		0.57	9-1478242-0	RG174A/U, 188A/U, 316/U, URM95, KX3B, KX22A	5-1814802-1		
		0.57	9-1478242-0	RG174A/U, 188A/U, 316/U, URM95, KX3B, KX22A	5-1814802-0		
		A	DIE SET	CABLE GROUPS	PART NO.		

NOTES

- 1 PACKAGE ONE COMPLETE CONNECTOR IN HEAT SEALED, LABELED BAG/ 50 BAGS PER INNER BOX/ 20 BOXES PER SHIPPING CARTON (TOTAL 1000 PCS PER SHIPPING CARTON)
- 2 100 TRAY PACK IN ACCORDANCE WITH AMP SPEC 107-3275
- 3 Au PLATING
- 4 Ni PLATING
- 5 HAND TOOL: 9-1478240-0
- 6 DIE SET: SEE TABLE
- 7 ELECTRICAL CHARACTERISTICS
 FREQUENCY RANGE: DC - 4 GHz
 NOMINAL IMPEDANCE: 50 Ohm
 INSULATION RESISTANCE: 5000 MOhm
 WORKING VOLTAGE: 500 Volts RMS at Sea Level
 DIELECTRIC WITHSTAND VOLTAGE: 1500 Volts RMS Max
 CONTACT RESISTANCE:
 CENTRE CONTACT: 1.50 mOhm Max
 OUTER CONTACT: 1.00 mOhm Max
 VSWR @ 4GHz: 1.30:1 Max
 INSERTION LOSS dB @ x 3 GHz: 0.20 Max
- 8 MECHANICAL CHARACTERISTICS
 CABLE RETENTION FORCE: RG58C/U: 170N Min
 CABLE RETENTION FORCE: RG174A/U: 85N Min
 MOUNT NUT RECOMMENDED TORQUE: 4N
 DURABILITY: 50 Cycles Min
- 9 ENVIRONMENTAL CHARACTERISTICS
 OPERATING TEMPERATURE: -65 to +85 DegC
- 10 FOR TECHNICAL DATA REFER TO YOUR LOCAL TYCO ELECTRONICS SALES OFFICE
- 11 ALL DIMENSIONS ARE NOMINAL FOR REFERENCE ONLY UNLESS OTHERWISE STATED

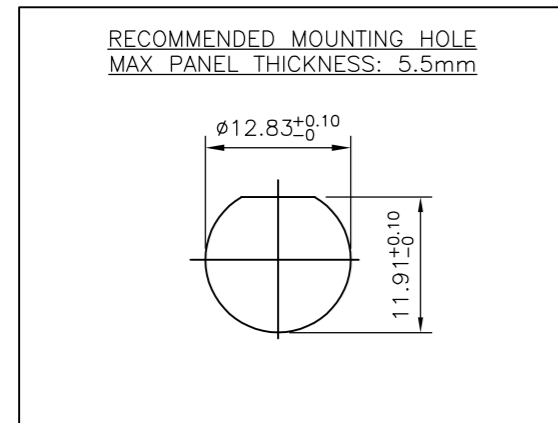
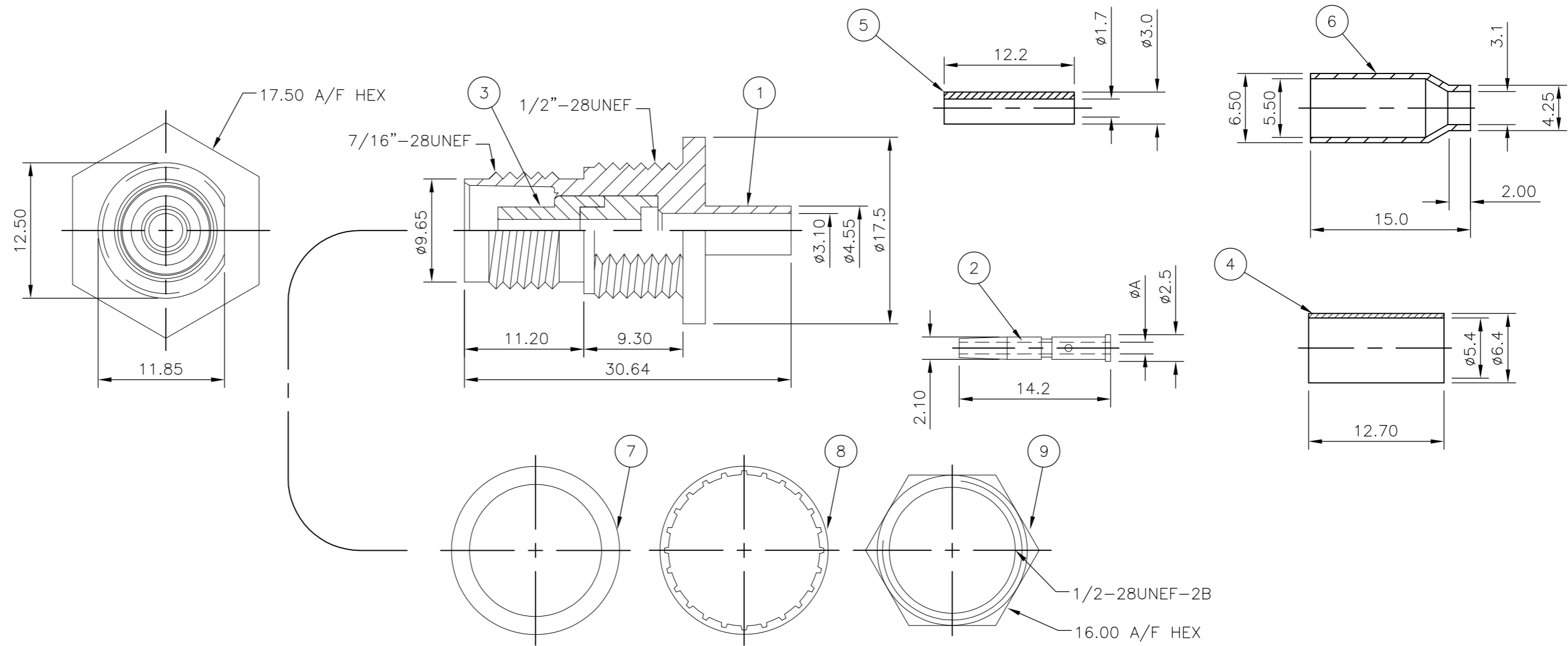

	OBSOLETE	OBSOLETE	OBSOLETE				
1	1	1	1	BRASS	⚠	HEXAGON NUT	9
1	1	1	1	PHOSPHOR BRONZE	⚠	WASHER	8
1	1	1	1	SILCON RUBBER		GASKET	7
-	-	-	-	BRASS	⚠	FERRULE	6
-	-	-	-	NYLON		PUSHER SLEEVE	5
1	1	-	-	BRASS	⚠	FERRULE	4
1	1	1	1	DELTRIN		INSULATOR	3
1	1	1	1	PHOSPHOR BRONZE	⚠	CONTACT	2
1	1	1	1	ZINC ALLOY	⚠	BODY	1
5	35	25	15				

THIS DRAWING IS A CONTROLLED DOCUMENT.		DWN J.SANDWELL 26SEP06	TE TE Connectivity TNC BULKHEAD CRIMP JACK - 50 OHM		
DIMENSIONS: MM		CHK S.PARLOW 26SEP06			
TOLERANCES UNLESS OTHERWISE SPECIFIED		APVD F.WHEELER-KING 26SEP06	PRODUCT SPEC		
0 PLC ± 1 PLC ± 2 PLC ± 3 PLC ± 4 PLC ± ANGLES ±		APPLICATION SPEC	108-112000	SIZE	
MATERIAL SEE TABLE		FINISH SEE TABLE	SEE SHEET 2	CAGE CODE	
		WEIGHT	-	DRAWING NO	
		CUSTOMER DRAWING		1814802	
		SCALE	NTS	SHEET 1 OF 2	
		REV	D		



THIS DRAWING IS UNPUBLISHED. RELEASED FOR PUBLICATION SEPTEMBER, 2004.
 © COPYRIGHT 2006 By - ALL RIGHTS RESERVED.

LOC	DIST	REVISIONS					
		P	LTR	DESCRIPTION	DATE	DWN	APVD
E	B	-	-	SEE SHEET 1	-	-	-

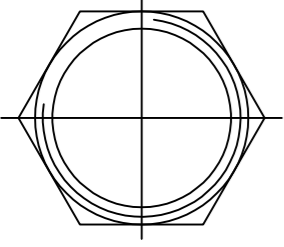
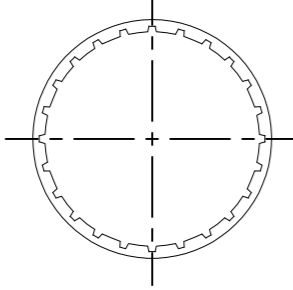
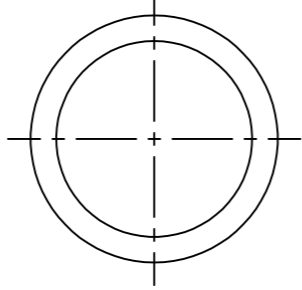
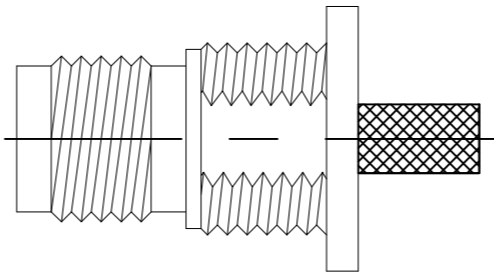
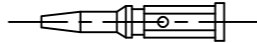
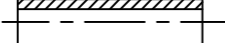
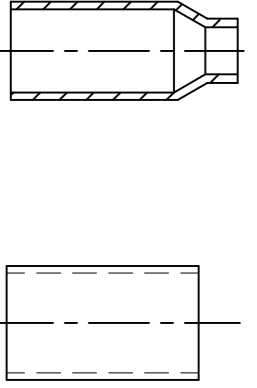
COMPONENTS

HEX NUT (ITEM 9)	LOCK WASHER (ITEM 8)	GASKET (ITEM 7)	MAIN BODY (ITEM 1,3,)	CENTRE CONTACT (ITEM 2)	PUSHER SLEEVE (ITEM 5)	CRIMP FERRULES (ITEM 4 & 6)
						

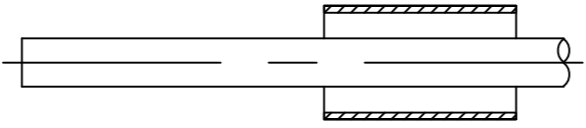
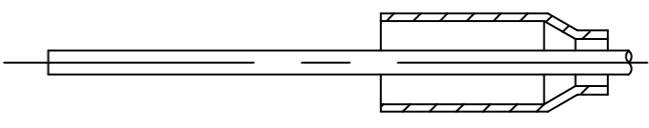
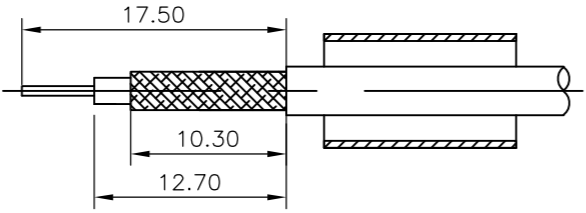
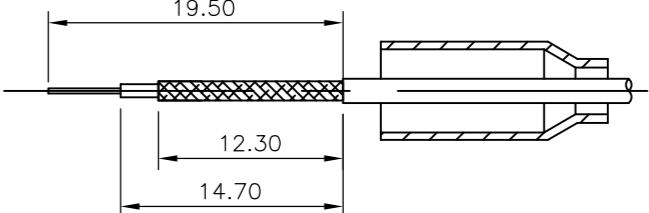
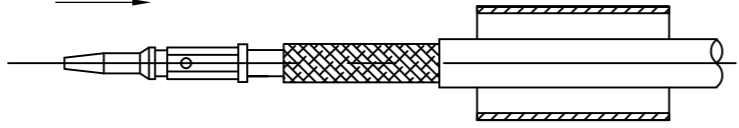
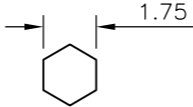
ASSEMBLY INSTRUCTION

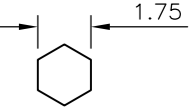
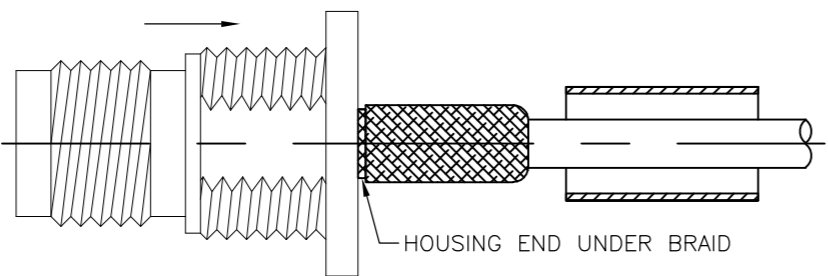
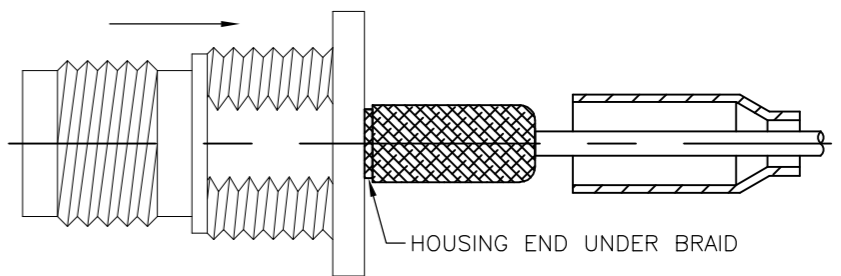
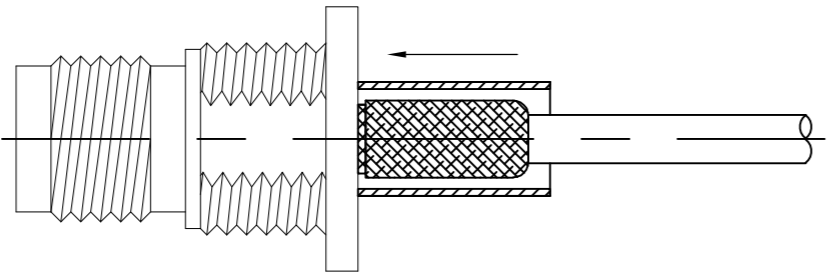
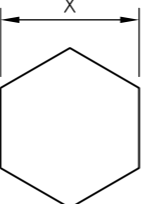
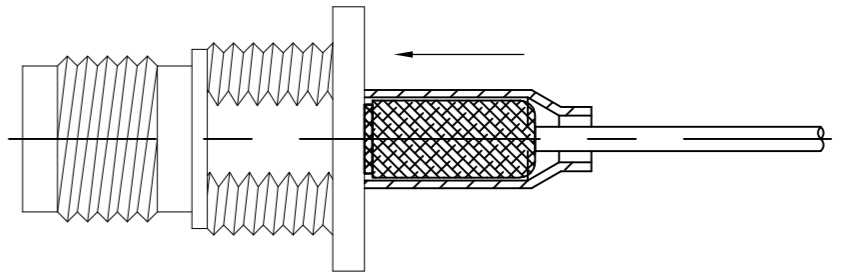
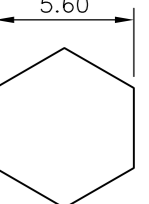
CABLES: RG59B/U, 62A/U, 140/U, 210/U, URM90, KX 6A, KX 25, KX 52, KX 53, RG58C/U, 141A/U, URM43, 76, BELDEN 9907, KX 15	CABLES: RG179B/U, 187A/U, URM111
<p>STEP 1</p> <p>1. SLIDE METAL CRIMP FERRULE OVER CABLE</p> 	<p>STEP 1</p> <p>1. SLIDE METAL CRIMP FERRULE OVER CABLE</p> 
<p>STEP 2</p> <p>1. STRIP CABLE TO DIMENSIONS AS SHOWN</p> 	<p>STEP 2</p> <p>1. STRIP CABLE TO DIMENSIONS AS SHOWN</p> 
<p>STEP 3</p> <p>1. FIT CONTACT OVER CENTRE CONDUCTOR TO BUTT AGAINST DIELECTRIC. 2. CRIMP USING TOOL AS NOTES ON PAGE 1.</p>  <p>RECOMMENDED CENTRE CONTACT A/F HEX</p> 	<p>STEP 3</p> <p>1. SLIDE ITEM 10 PUSHER SLEEVE OVER DIELECTRIC BEFORE FITTING THE CONTACT. 2. FIT CONTACT OVER CENTRE CONDUCTOR TO BUTT AGAINST DIELECTRIC. 3. CRIMP USING TOOL AS NOTES ON PAGE 1.</p>  <p>RECOMMENDED CENTRE CONTACT A/F HEX</p> 
<p>STEP 4</p> <p>1. PRESS SUB-ASSEMBLY INTO BODY, UNTIL CONTACT IS FULLY LOCATED BY AN AUDIBLE CLICK. 2. ENSURE THAT KNURLED HOUSING INSERTS BETWEEN THE DIELECTRIC AND CABLE BRAID.</p>  <p>HOUSING END UNDER BRAID</p>	<p>STEP 4</p> <p>1. PRESS SUB-ASSEMBLY INTO BODY, UNTIL CONTACT IS FULLY LOCATED BY AN AUDIBLE CLICK. 2. ENSURE THAT KNURLED HOUSING INSERTS BETWEEN THE PUSHER SLEEVE AND CABLE BRAID.</p>  <p>HOUSING END UNDER BRAID</p>
<p>STEP 5</p> <p>1. SLIDE CRIMP FERRULE ALONG THE CABLE UNTIL IT BUTTS AGAINST THE HOUSING BODY. 2. CRIMP USING TOOL AS NOTED ON PAGE 1. 3. CRIMP DIMENSION X IS:- RG59B (SEE PAGE 1 FOR FULL CABLE LIST) = 6.50 RG58C/U (SEE PAGE 1 FOR FULL CABLE LIST) = 5.60</p>  <p>RECOMMENDED CRIMP SLEEVE A/F HEX</p> 	<p>STEP 5</p> <p>1. SLIDE CRIMP FERRULE ALONG THE CABLE UNTIL IT BUTTS AGAINST THE BODY HOUSING. 2. CRIMP USING TOOL AS NOTED ON PAGE 1. 3. CRIMP DIMENSION AS SHOWN.</p>  <p>RECOMMENDED CRIMP SLEEVE A/F HEX</p> 

THIS DRAWING IS A CONTROLLED DOCUMENT.

DWN	RITA ZUO	11 Mar 09
CHK	ANSON MA	11 Mar 09
APVD	BOB ZHAO	11 Mar 09
PRODUCT SPEC	108-112000	
APPLICATION SPEC	SEE SHEET 2	
WEIGHT	-	
CUSTOMER DRAWING		

TE Connectivity

TNC BULKHEAD CRIMP JACK - 50 OHM

SIZE: A2 CAGE CODE: 00779 DRAWING NO: 1814802 RESTRICTED TO: -

SCALE: NTS SHEET: 2 OF 2 REV: D

X-ON Electronics

Largest Supplier of Electrical and Electronic Components

Click to view similar products for [RF Connectors / Coaxial Connectors](#) category:

Click to view products by [TE Connectivity](#) manufacturer:

Other Similar products are found below :

[8915-1511-000](#) [89674-0827](#) [6001-7071-019](#) [6002-7051-003](#) [6002-7551-202](#) [6059674-1](#) [619550-1](#) [630059-000](#) [M39030/3-01N](#) [6500-7071-046](#) [6769](#) [CX050L2AQ](#) [7002-1541-010](#) [7002-1542-011](#) [7004-1512-000](#) [7009-1511-004](#) [7010-1511-000](#) [7029-1511-060](#) [7101-1541-010](#) [7101-1571-002](#) [7105-1521-002](#) [7145-1521-002](#) [7203-1571-003](#) [7209-1511-011](#) [7210-1511-015](#) [7210-1511-019](#) [73137-5015](#) [73216-2241](#) [73404-2300](#) [7405-1521-005](#) [7405-1521-802](#) [8527](#) [8547](#) [FS11V](#) [877931](#) [9049-9513-000](#) [9074-9513-000](#) [9101-9573-002](#) [910A205F](#) [9130-9573-002](#) [PL11SC-026](#) [PL375-33](#) [PL40-5](#) [PL74C-221](#) [PL75MC-217](#) [PL803-7](#) [1200690078](#) [1-201144-1](#) [R107003010W](#) [R110A172100](#)