

THIS DRAWING IS UNPUBLISHED. RELEASED FOR PUBLICATION 20
 © COPYRIGHT 20 BY Tyco Electronics Japan G.K. ALL RIGHTS RESERVED.

LOC	DIST	REVISIONS					
		P	LTR	DESCRIPTION	DATE	DWN	APVD
J	-		D	REVISED	14JUL2010	HMR	TM
			E	ITEM ADDITION	13JUN2011	M.M	N.Y

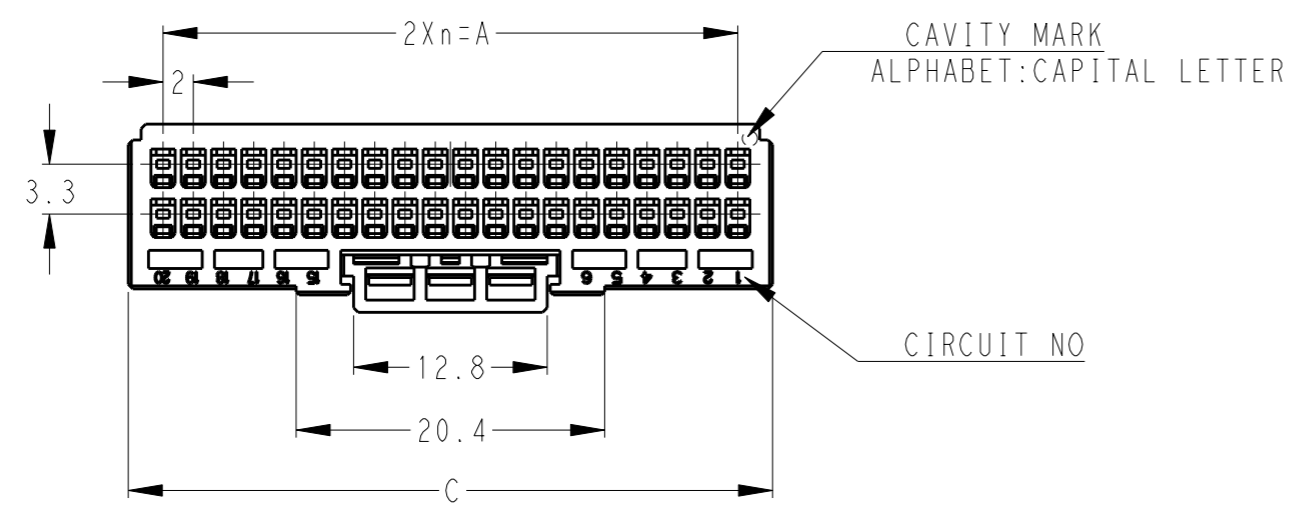

1 MATERIAL: GLASS FILED THERMO PLASTIC POLYESTER(94V-0)

2 COLOR: SEE TABLE

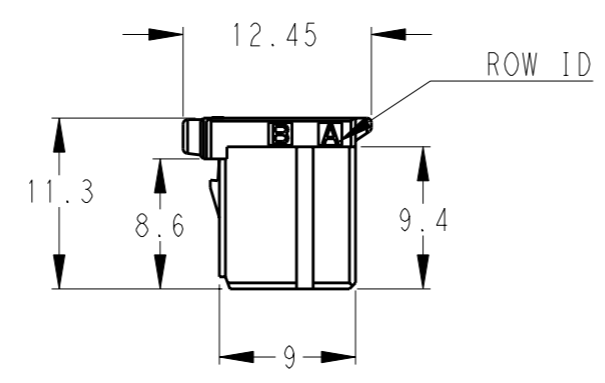
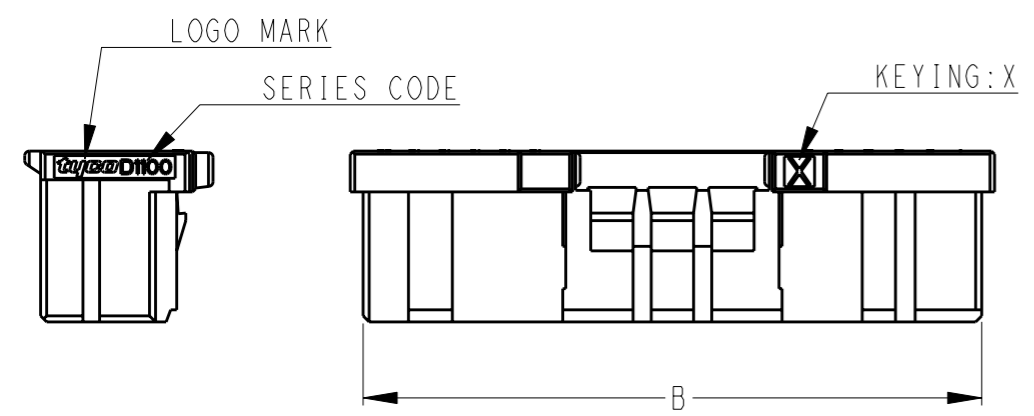

- 5-1871057-□ : RED (X-KEY)
- 3-1871057-□ : YELLOW (X-KEY)
- 1-1871057-□ : NATURAL (X-KEY)

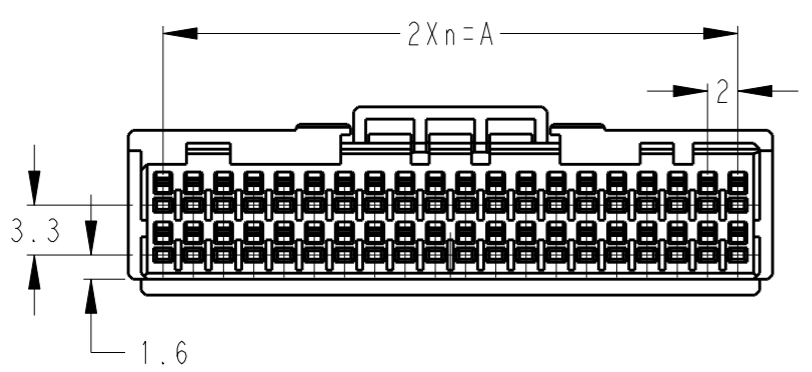

POS	KEY	n	A	B	C	COLOR	PART NO
40	X	19	38.0	40.9	42.6	RED	5-1871057-0
40	X	19	38.0	40.9	42.6	YELLOW	3-1871057-0
40	X	19	38.0	40.9	42.6	NATURAL	1-1871057-0
32	X	15	30.0	32.9	34.6	NATURAL	1-1871057-6
30	X	14	28.0	30.9	32.6	YELLOW	3-1871057-5
30	X	14	28.0	30.9	32.6	NATURAL	1-1871057-5
28	X	13	26.0	28.9	30.6	RED	5-1871057-4
26	X	12	24.0	26.9	28.6	NATURAL	1-1871057-3
24	X	11	22.0	24.9	26.6	YELLOW	3-1871057-2
22	X	10	20.0	22.9	24.6	YELLOW	3-1871057-1
22	X	10	20.0	22.9	24.6	NATURAL	1-1871057-1

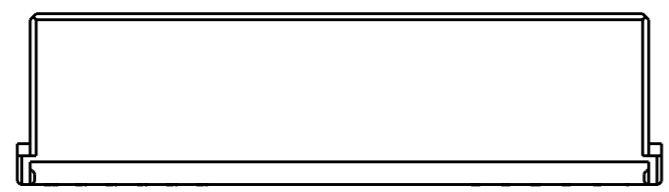

40POS(X-KEY):
 1-1871057-0(NATURAL)
 3-1871057-0(YELLOW)
 5-1871057-0(RED)

THIS DRAWING IS A CONTROLLED DOCUMENT.		DWN T.KUDO 21APR2005	TE Connectivity	
DIMENSIONS: mm		CHK D.MITSUGI 23AUG2005		
TOLERANCES UNLESS OTHERWISE SPECIFIED: ±0.3, ±5°		APVD D.MITSUGI 23AUG2005	NAME DYNAMIC 1100D 2.0mmPITCH REC HSG COLOR 22-40POS	
0 PLC ± 1 PLC ±0.1 2 PLC ±0.02 3 PLC ±0.005 4 PLC ±0.0005 ANGLES ±		PRODUCT SPEC 108-78268,78298	SIZE A3	
MATERIAL		APPLICATION SPEC 114-5377	CAGE CODE 00779	DRAWING NO C-1871057
FINISH -		WEIGHT -	RESTRICTED TO -	
		CUSTOMER DRAWING	SCALE 2:1	SHEET 1 OF 3 REV E

LOC	DIST	REVISIONS					
J	-	P	LTR	DESCRIPTION	DATE	DWN	APVD
				SEE SHEET 1 OF 2			

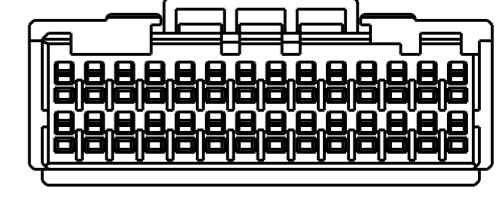
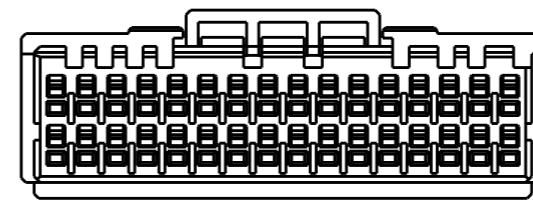
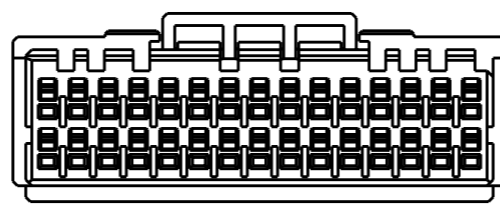
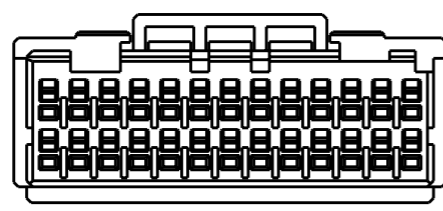
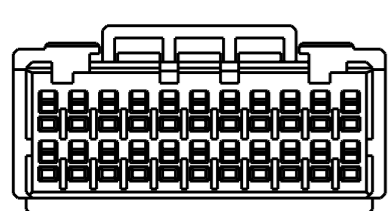
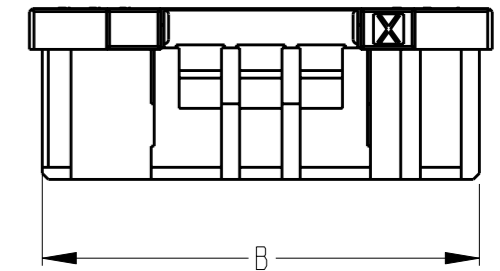
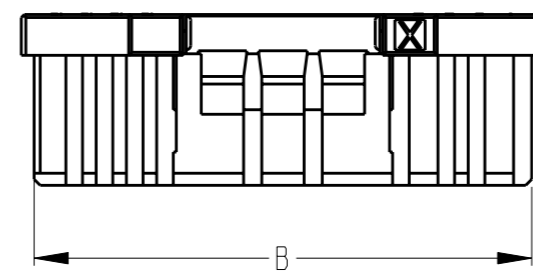
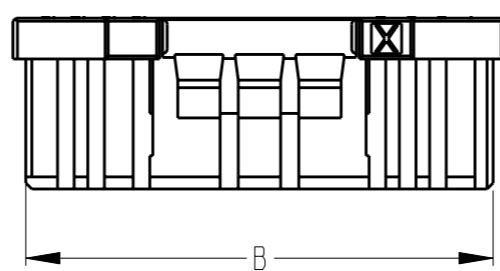
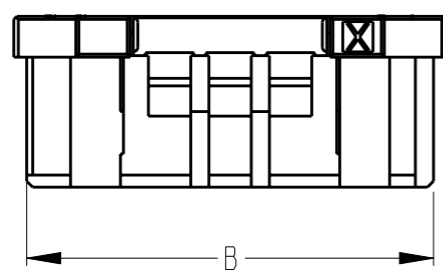
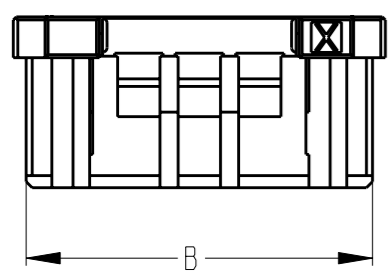
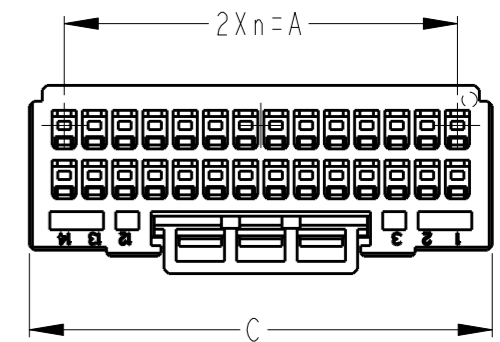
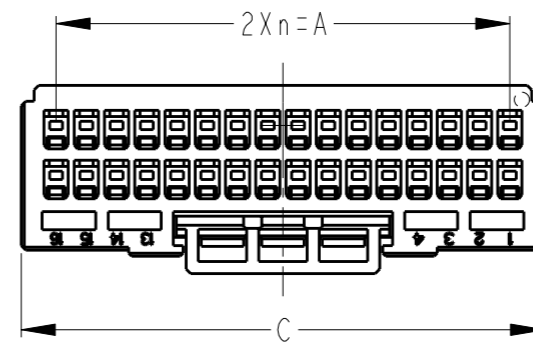
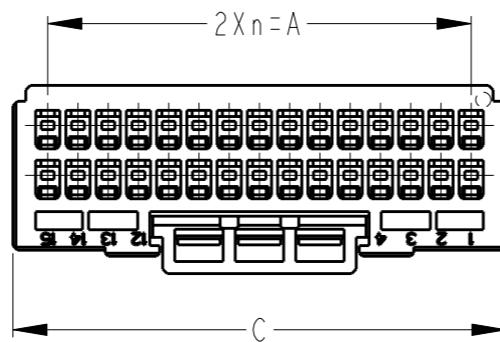
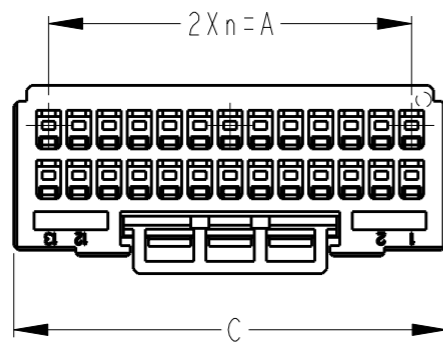
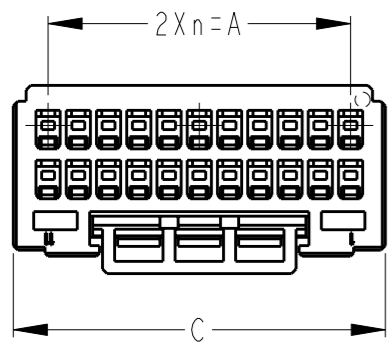

22POS(X-KEY):
 1-1871057-1(NATURAL)
 3-1871057-1(YELLOW)

26POS(X-KEY):
 1-1871057-3(NATURAL)

30POS(X-KEY):
 1-1871057-5(NATURAL)
 3-1871057-5(YELLOW)

32POS(X-KEY):
 1-1871057-6(NATURAL)

28POS(X-KEY):
 5-1871057-4(RED)

THIS DRAWING IS A CONTROLLED DOCUMENT.		DWN T. KUDO	21APR2005	 TE Connectivity	
DIMENSIONS: mm		CHK D. MITSUGI	23AUG2005		
TOLERANCES UNLESS OTHERWISE SPECIFIED:		APVD D. MITSUGI	23AUG2005	NAME DYNAMIC 1100D 2.0mmPITCH REC HSG COLOR 22-40POS	
0 PLC ±-		PRODUCT SPEC	108-78268,78298	SIZE A3	
1 PLC ±0.1		APPLICATION SPEC	114-5377	CAGE CODE	00779
2 PLC ±0.02		WEIGHT	-	DRAWING NO	1871057
3 PLC ±0.005		CUSTOMER DRAWING		RESTRICTED TO	-
4 PLC ±0.0005		SCALE		2:1	SHEET 2 OF 3
ANGLES ±-		REV		E	
MATERIAL					
FINISH					

SEE SHEET 1 OF 2

THIS DRAWING IS UNPUBLISHED.

RELEASED FOR PUBLICATION

20

© COPYRIGHT 20

BY Tyco Electronics Japan G.K.

ALL RIGHTS RESERVED.

LOC	DIST	REVISIONS			
P	LTR	DESCRIPTION	DATE	DWN	APVD
J	-	SEE SHEET 1 OF 2			

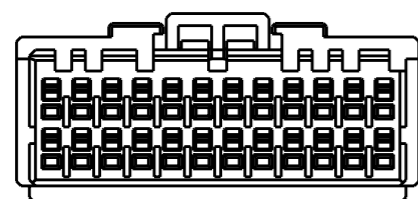
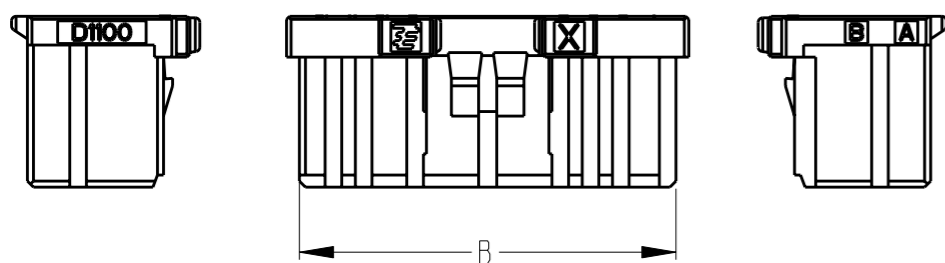
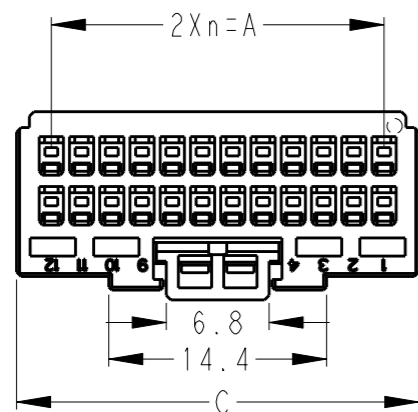

24POS(X-KEY):
3-1871057-2(YELLOW)

THIS DRAWING IS A CONTROLLED DOCUMENT.		DWN T. KUDO	21APR2005	 TE Connectivity	
DIMENSIONS: mm		CHK D. MITSUGI	23AUG2005		
TOLERANCES UNLESS OTHERWISE SPECIFIED:		APVD D. MITSUGI	23AUG2005	NAME DYNAMIC 1100D 2.0mmPITCH REC HSG COLOR 22-40POS	
0 PLC ±-		PRODUCT SPEC	108-78268, 78298	SIZE	A3
1 PLC ±0.5		APPLICATION SPEC	114-5377	CAGE CODE	00779
2 PLC ±0.13		WEIGHT	-	DRAWING NO	C-1871057
3 PLC ±0.013		CUSTOMER DRAWING		RESTRICTED TO	-
4 PLC ±0.0001				SCALE	2:1
ANGLES ±-				SHEET	3 OF 3
MATERIAL	-			REV	E

SEE SHEET 1 OF 2

X-ON Electronics

Largest Supplier of Electrical and Electronic Components

Click to view similar products for [Headers & Wire Housings](#) category:

Click to view products by [TE Connectivity](#) manufacturer:

Other Similar products are found below :

[95000-104TRLF](#) [10135584-644402LF](#) [DF62W-EP2022PCA](#) [95000-106TRLF](#) [DF62W-2022SCA](#) [DF62W-EP2022PC](#) [2203348](#) [DF62W-2022SC](#) [1084018](#) [1029039](#) [1084017](#) [802-10-012-10-002000](#) [1112640](#) [1112639](#) [891-007-9SS-BST1T](#) [000-34000](#) [0008550134](#) [0009482033](#) [0009507031](#) [57102-F02-18ULF](#) [57102-S06-03LF](#) [57202-S52-04LF](#) [PCN6-15S-2.5E](#) [0039019024](#) [58102-G61-06LF](#) [582553-1](#) [0009485154](#) [0009508121](#) [0022285053](#) [0050291907](#) [018731A](#) [LY20-4P-DT1-P1E-BR](#) [02.125.8002.8](#) [60101931](#) [60598-1 \(Cut Strip\)](#) [M1625-3R/100](#) [61062-3](#) [61082-181009](#) [CSU011177004](#) [636-1427](#) [638009-1](#) [641938-9](#) [641991-4](#) [644168-1](#) [644827-2](#) [647662-1](#) [65039-019ELF](#) [65692-001LF](#) [65781-018](#) [65781-047](#)