

LOC		DIST		REVISIONS			
P	LTN	DESCRIPTION	DATE	DWN	APVD		
E		REVISED PER ECR-21-100678	08APR2021	SS	VS		
F		REVISED PER ECR-20-100915	28APR2021	JP	VS		

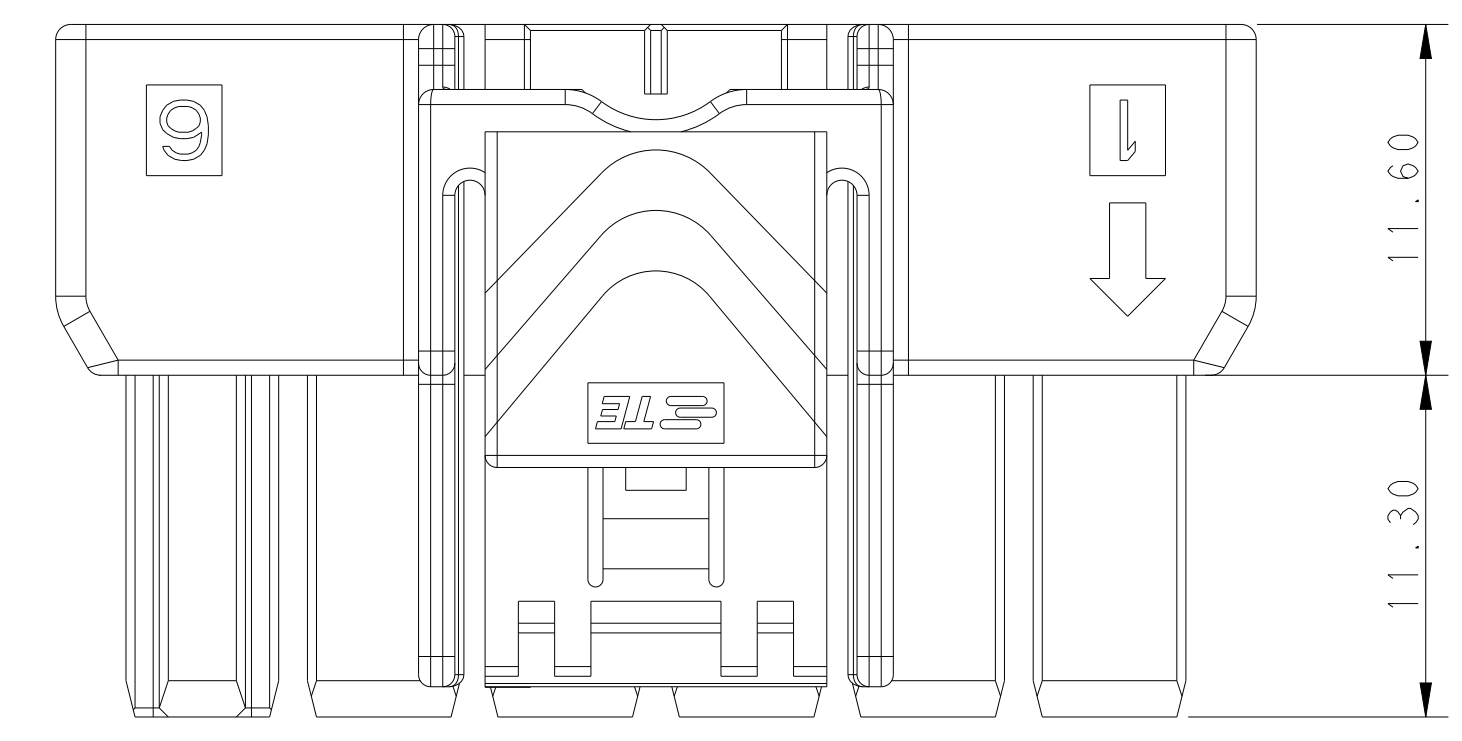

POS.	DIM. A
2*6	39.70
2*5	33.70
2*4	27.70
2*3	21.70

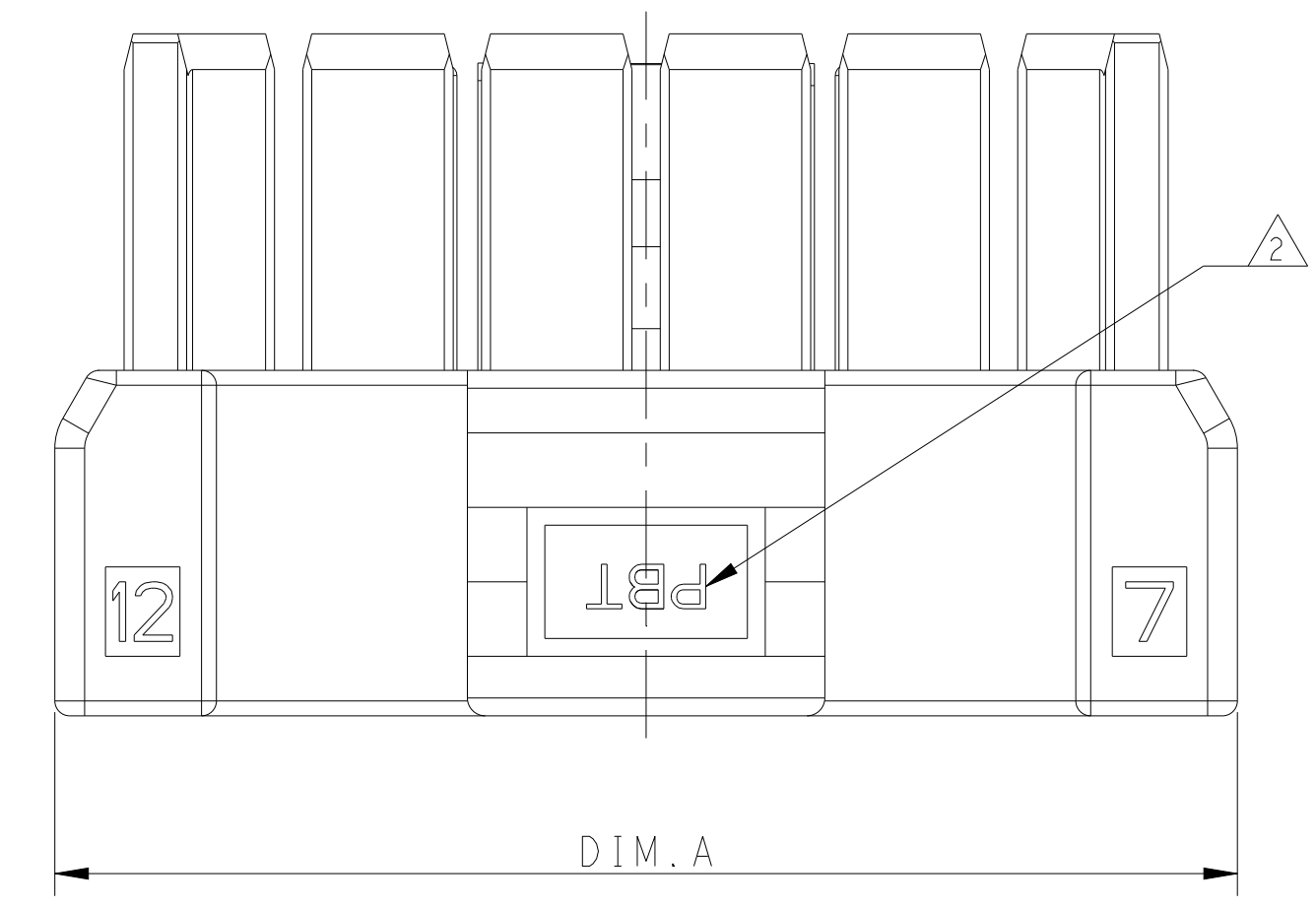
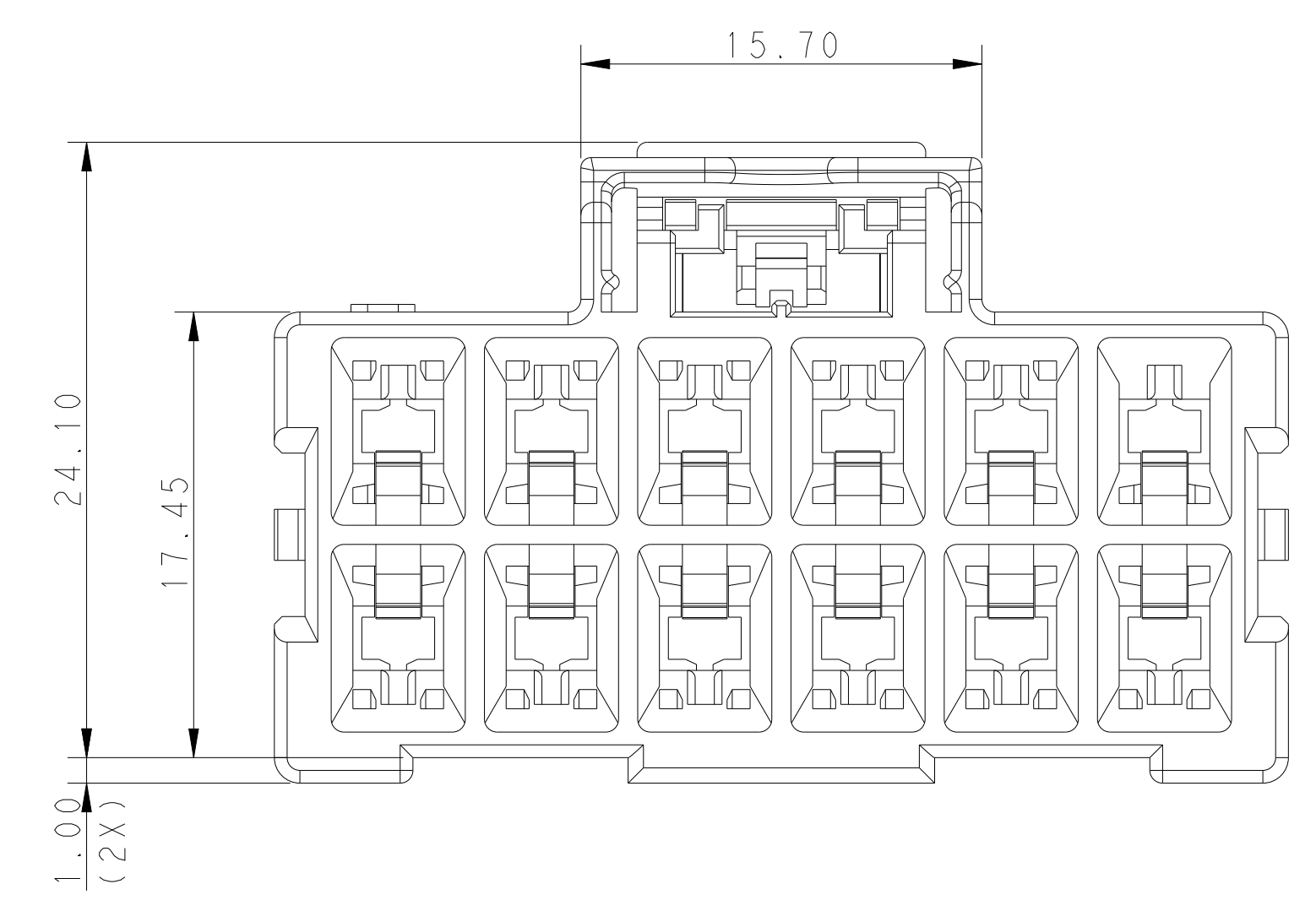
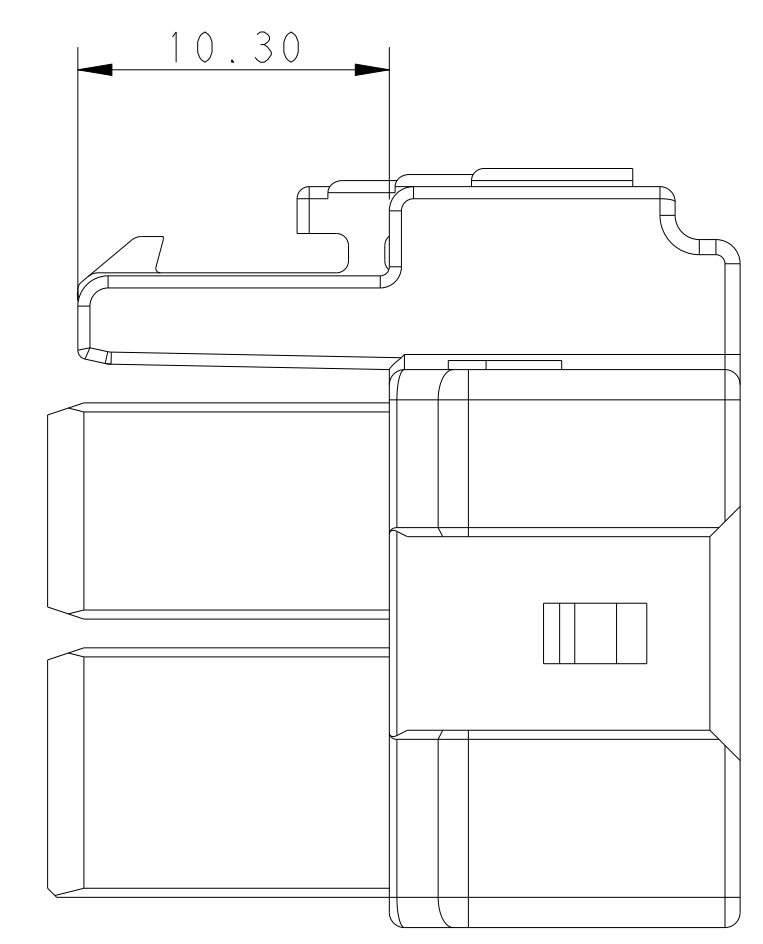
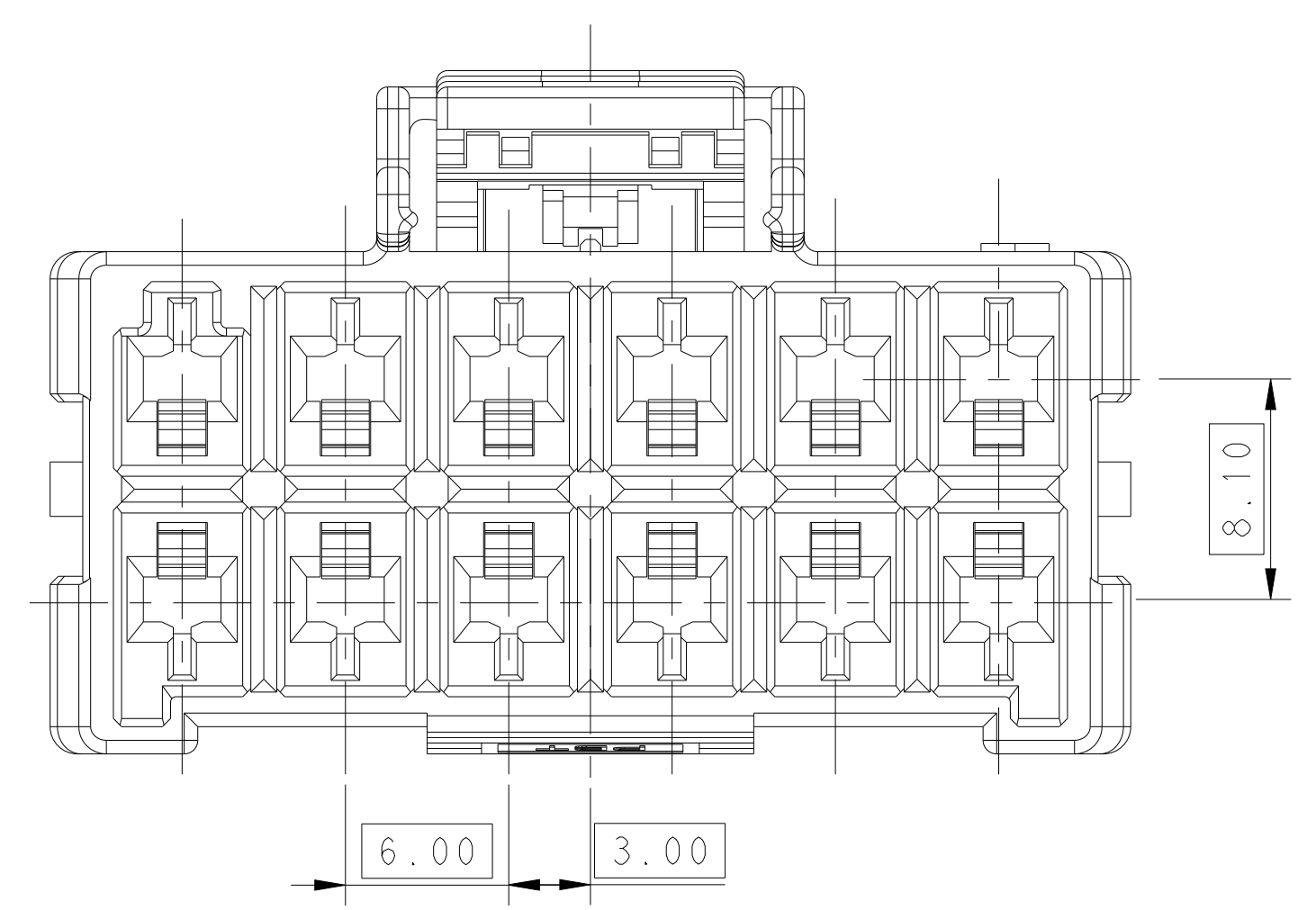

⚠ MATERIAL:
 LEVEL 1: PBT, STANDARD TEMPERATURE 105°C
 KEY A: NATURAL; KEY B: PURPLE; KEY C: BLUE; KEY D: YELLOW
 LEVEL 2: PA66, HIGH TEMPERATURE 150°C
 KEY A: LIGHT GREY; KEY B: RED; KEY C: BLACK; KEY D: NATURAL

⚠ MATERIAL MARK:
 LEVEL 1: PBT, LEVEL 2: HDT
 3. APPLICABLE CONTACT P/N
 RECEPTACLE CONTACT: 1971237/1971779/81/83/85/87-*, 2238066-*

⚠ 4. MATING CONN, P/N
 CAP HSG: *-1971774/5-
 TPA (LOCKING PLATE): *-1971778-*

⚠ 5. GLOW WIRE COMPLIANT IN ACCORDANCE WITH IEC 60335-1. THIS IS BASED ON THE PRODUCT MEETING A GWEPT 850° C TEST AND RESIN GWIT GREATER THAN OR EQUAL TO 775° C.

THIS DRAWING IS A CONTROLLED DOCUMENT.		DWN: TOMMY WU 09JUL2012	TE Connectivity PLUG HOUSING, DOUBLE ROW POWER TRIPLE LOCK
DIMENSIONS: mm		CHK: HAPYE WU 09JUL2012	
TOLERANCES UNLESS OTHERWISE SPECIFIED:		APVD: YUHONG MAO 09JUL2012	
0 PLC ± 1 PLC ±0.35 2 PLC ±0.25 3 PLC ± 4 PLC ± ANGLES ± FINISH ±		NAME: YUHONG MAO PRODUCT SPEC: 108-106118 APPLICATION SPEC: 114-106118 WEIGHT: - Customer Drawing	
MATERIAL: ⚠		SIZE: A1	CAGE CODE: 00779 DRAWING NO: C=1971776 RESTRICTED TO: - SCALE: 4:1 SHEET 1 OF 2 REV F

LOC		DIST		REVISIONS			
P	LTN	DESCRIPTION	DATE	OWN	APVD		
-	-	SEE SHEET 1	-	-	-		

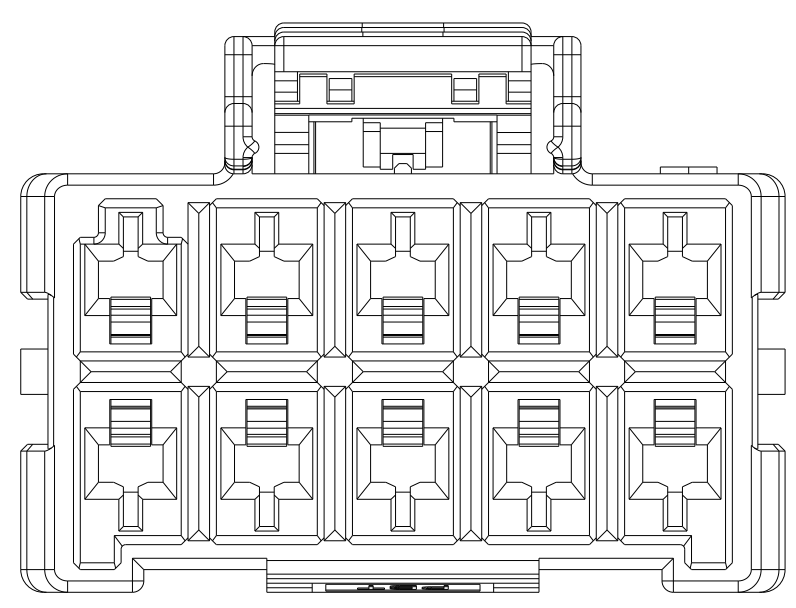
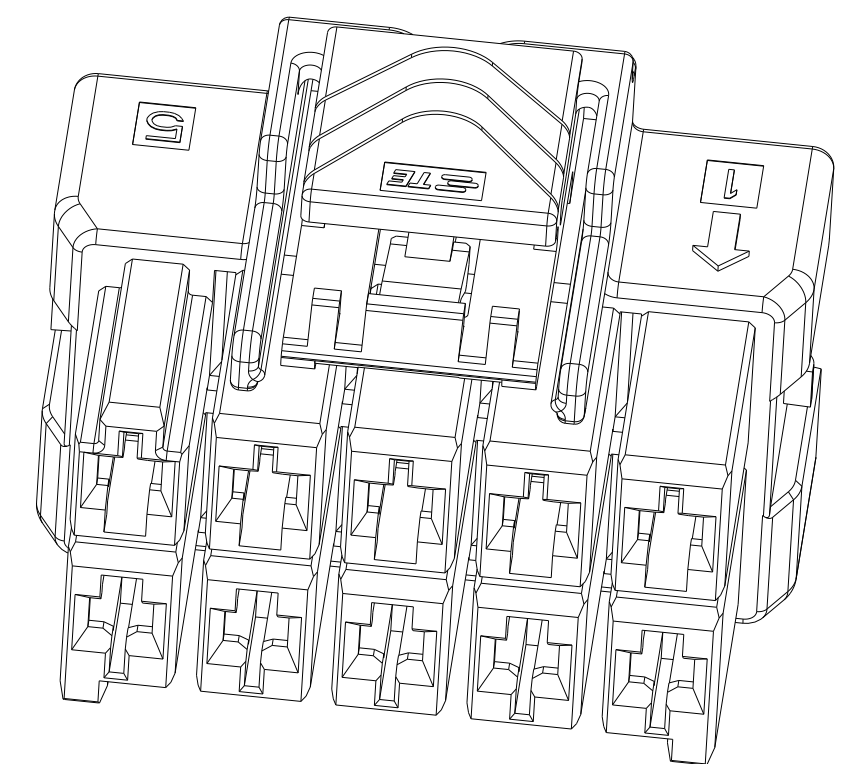

2*5 POSITIONS

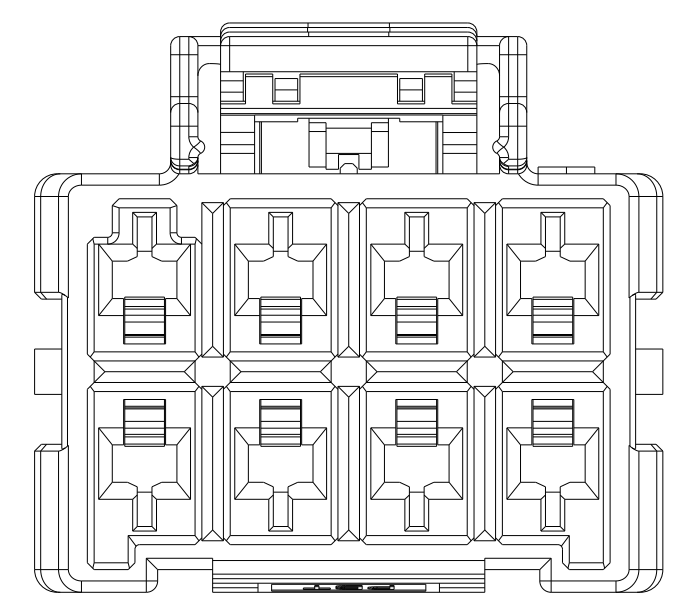
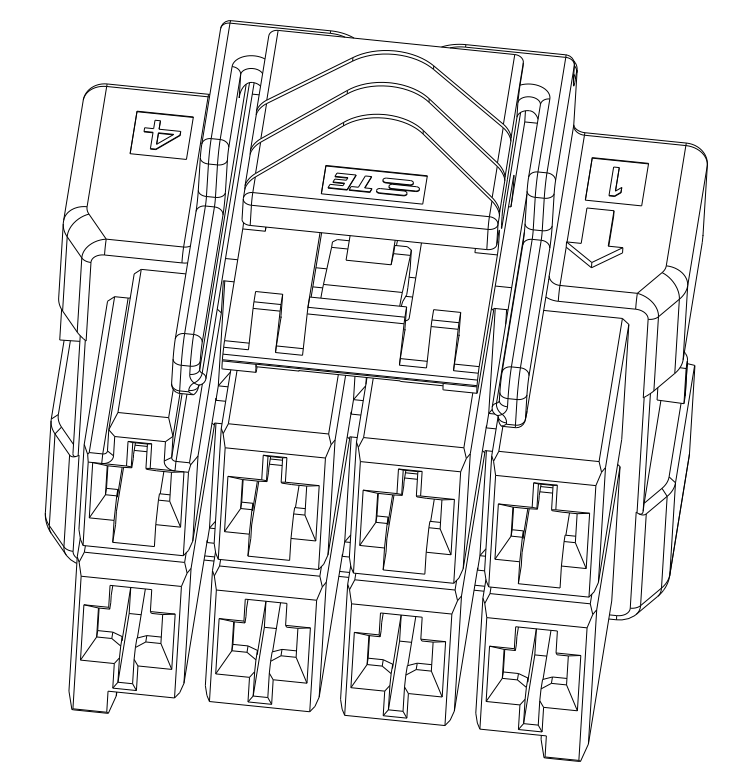

2*4 POSITIONS

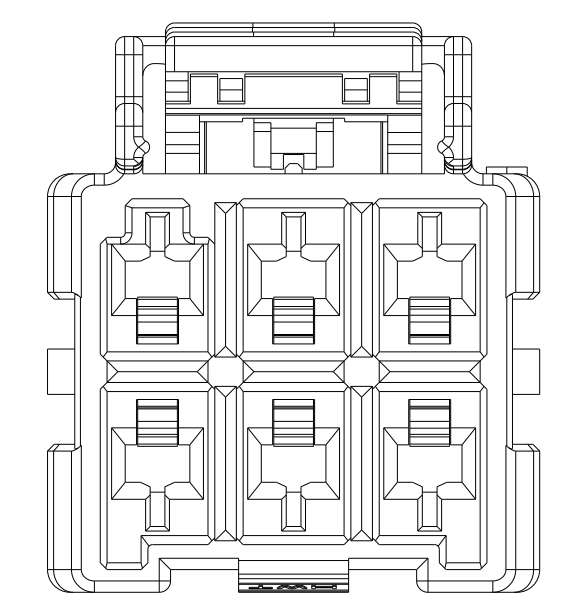
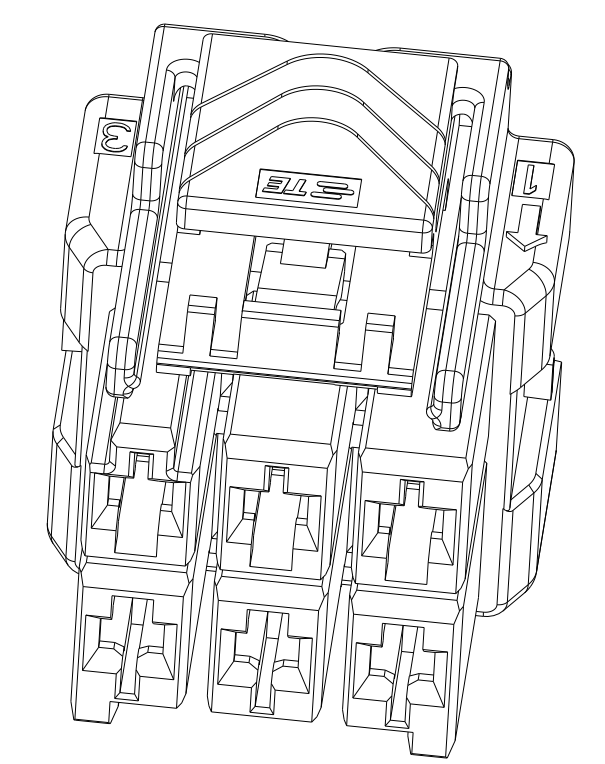

2*3 POSITIONS

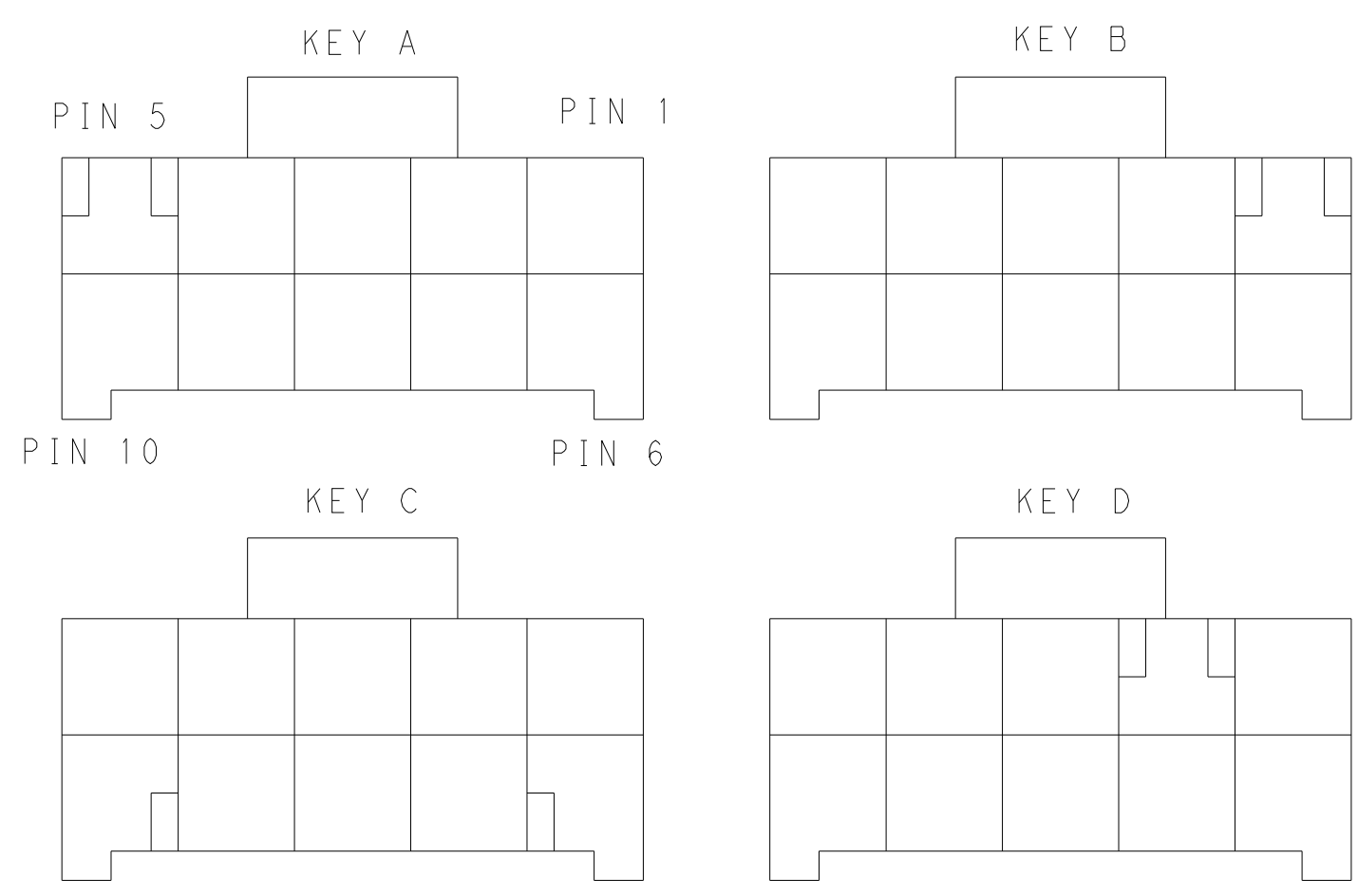

KEYING FOR 2*5 POS.

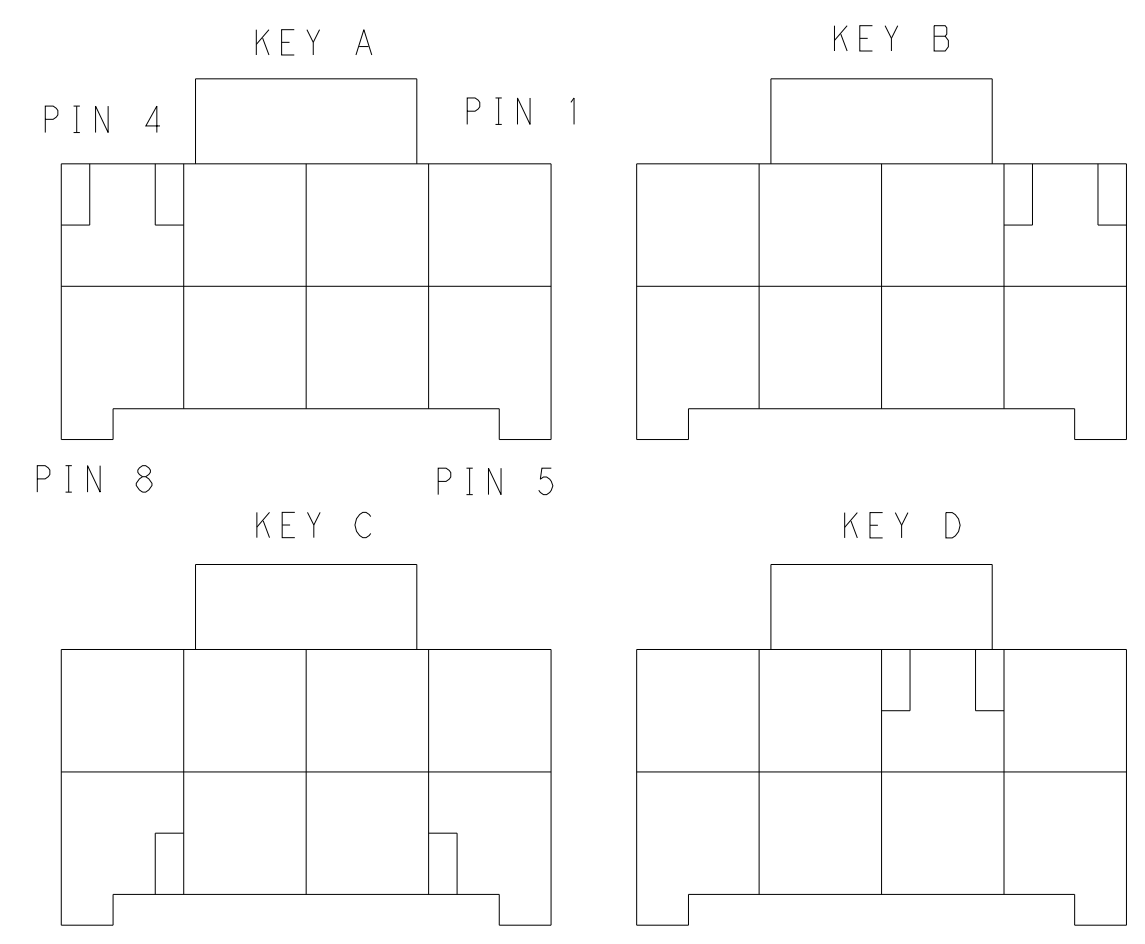

KEYING FOR 2*4 POS.

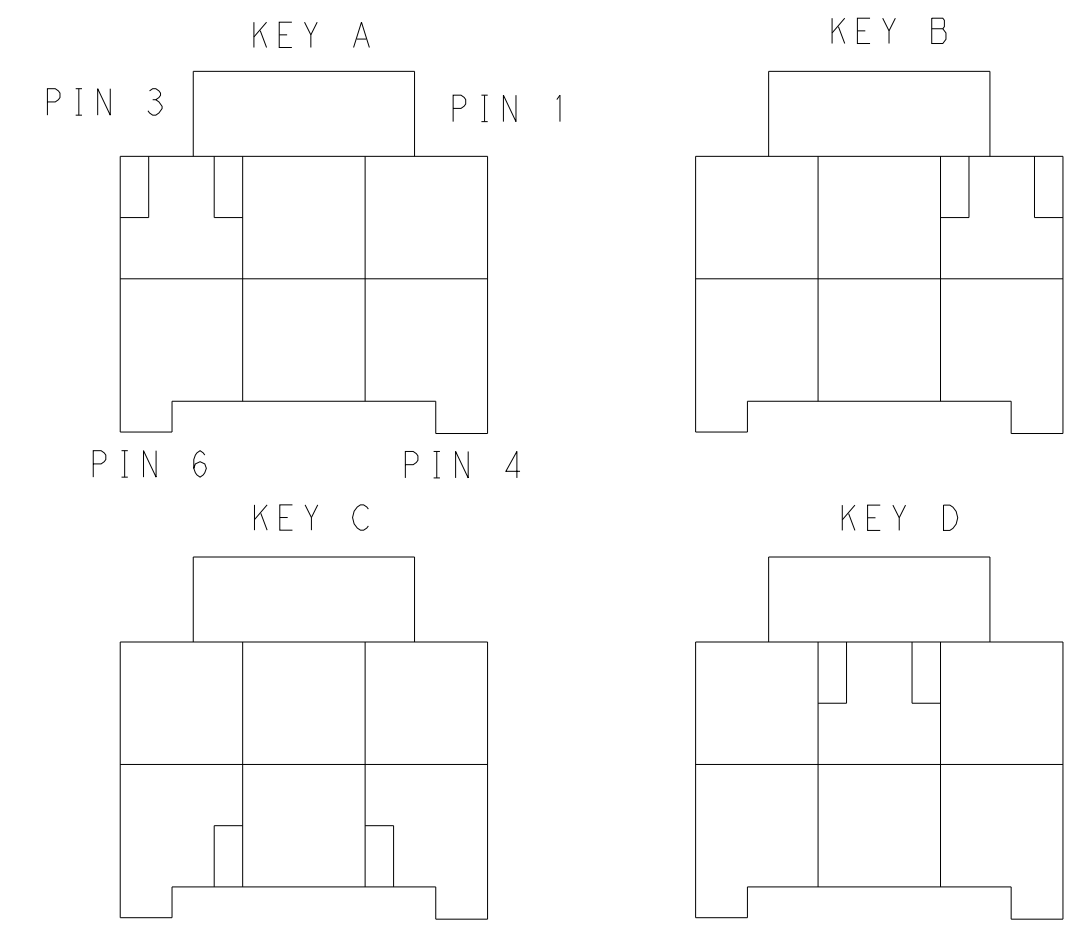

KEYING FOR 2*3 POS.

POS.	MATERIAL	KEY	P/N
2*6	LEVEL 1	KEY A	1-1971776-6
		KEY B	2-1971776-6
		KEY C	3-1971776-6
		KEY D	4-1971776-6
2*6	LEVEL 2	KEY A	5-1971776-6
		KEY B	6-1971776-6
		KEY C	7-1971776-6
		KEY D	8-1971776-6
2*5	LEVEL 1	KEY A	1-1971776-5
		KEY B	2-1971776-5
		KEY C	3-1971776-5
		KEY D	4-1971776-5
2*5	LEVEL 2	KEY A	5-1971776-5
		KEY B	6-1971776-5
		KEY C	7-1971776-5
		KEY D	8-1971776-5

POS.	MATERIAL	KEY	P/N
2*4	LEVEL 1	KEY A	1-1971776-4
		KEY B	2-1971776-4
		KEY C	3-1971776-4
		KEY D	4-1971776-4
2*4	LEVEL 2	KEY A	5-1971776-4
		KEY B	6-1971776-4
		KEY C	7-1971776-4
		KEY D	8-1971776-4
2*3	LEVEL 1	KEY A	1-1971776-3
		KEY B	2-1971776-3
		KEY C	3-1971776-3
		KEY D	4-1971776-3
2*3	LEVEL 2	KEY A	5-1971776-3
		KEY B	6-1971776-3
		KEY C	7-1971776-3
		KEY D	8-1971776-3

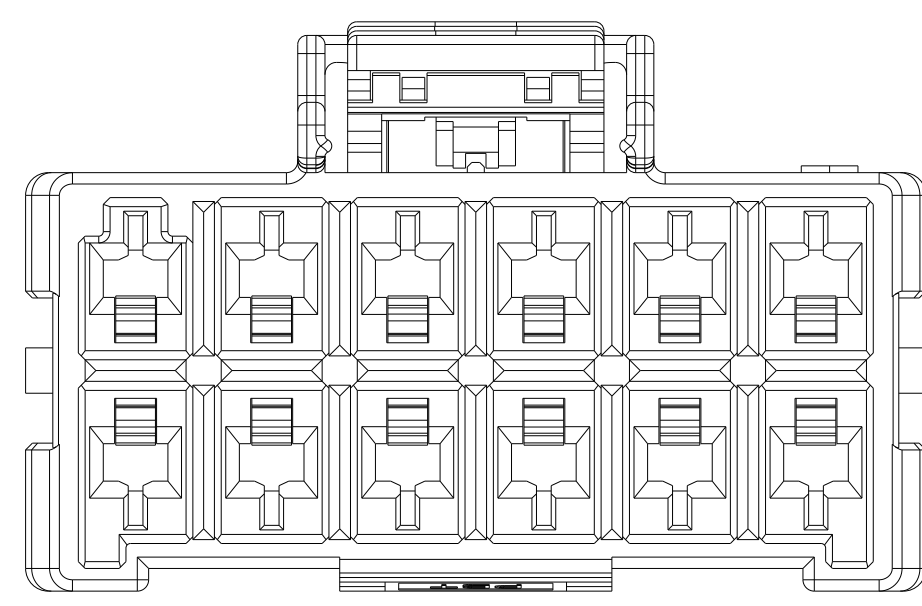
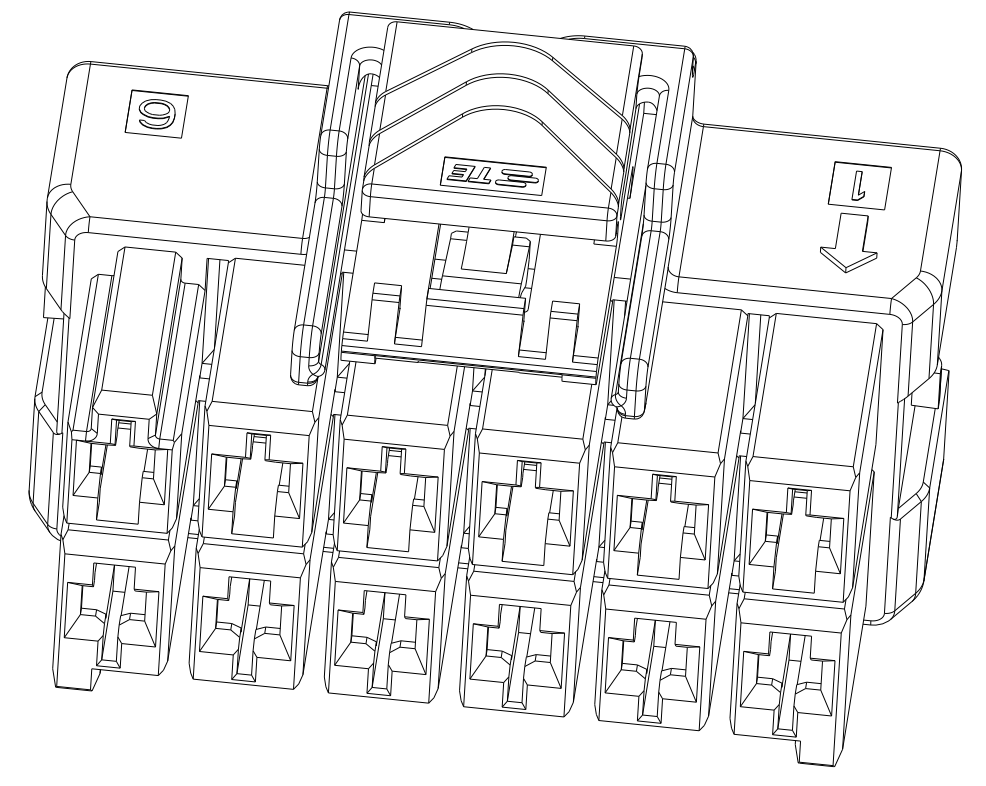

2*6 POSITIONS

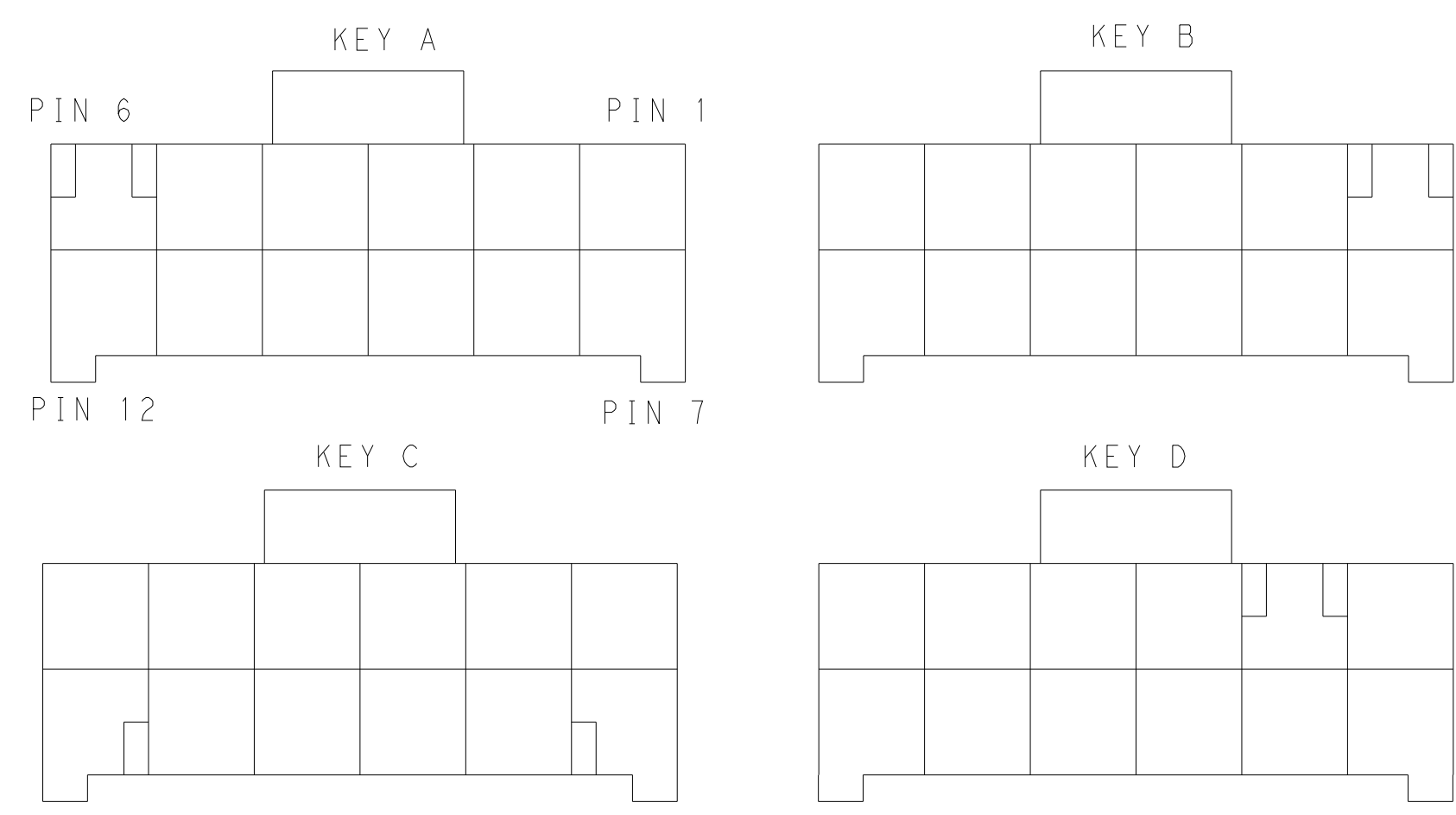

KEYING FOR 2*6 POS.

THIS DRAWING IS A CONTROLLED DOCUMENT. DWN TOMMY WU 09JUL2012
 CHK HAPYE WU 09JUL2012
 APVD YUHONG MAO 09JUL2012

STE TE Connectivity

NAME: PLUG HOUSING, DOUBLE ROW POWER TRIPLE LOCK

PRODUCT SPEC: 108-106118
 APPLICATION SPEC: 114-106118

SIZE: A1 CAGE CODE: 00779 DRAWING NO: 1971776
 SHEET 2 OF 2 REV F

MATERIAL: . FINISH: . WEIGHT: . SCALE: 4:1

Customer Drawing

X-ON Electronics

Largest Supplier of Electrical and Electronic Components

Click to view similar products for [Headers & Wire Housings](#) category:

Click to view products by [TE Connectivity](#) manufacturer:

Other Similar products are found below :

[892-18-020-10-001101](#) [58102-G61-06LF](#) [582553-1](#) [0009485154](#) [009176003701906](#) [0050291907](#) [LY20-4P-DT1-P1E-BR](#) [02.125.8002.8](#)
[609-3404](#) [61062-3](#) [61082-181009](#) [622-3653LF](#) [63453-116](#) [636-1030](#) [636-1427](#) [636-3427](#) [636-4007](#) [641938-9](#) [641991-4](#) [644827-2](#) [65817-010LF](#) [65817-015LF](#) [65863-015LF](#) [66207-023LF](#) [67095-007LF](#) [67601157](#) [68645-018](#) [68648-049](#) [70.362.1628.0](#) [70-4210](#) [70-4226B](#) [70-4853B](#) [707-5020](#) [707-5028](#) [71.350.2428.0](#) [71918-208LF](#) [71961-016LF](#) [733-134](#) [733-162](#) [754199-000](#) [760-3052](#) [787-8014-00](#) [79531-3000](#)
[FCN-360C032-B](#) [FCN-367T-T012/H](#) [FCN-723D010/2](#) [80.063.4001.1](#) [800-90-001-10-001000](#) [800-90-010-10-002000](#) [801-43-002-10-013000](#)