



Dynamic Series Connectors





2020 Edition

RoHS
Ready 

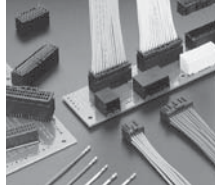
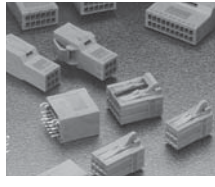

DYNAMIC SERIES CONNECTORS

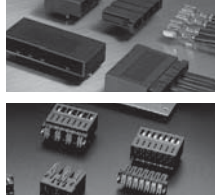
List of the Dynamic series

| Series Name | | | | Mechanical performance | | | | | | | | | | | |
|-------------------------------------|---|---------------|------------------------------|------------------------|------------------|---|-----|---|-------------|---------|-----|------|----------------|---------------------|----------------------------|
| Series | Family images | Spec.Name | Description | Wire-to-Wire | Mounting Methods | | | | | | | | Board to Board | Number of Positions | |
| | | | | | Wire-to-board | | | | Panel Mount | DIN Rai | Tap | Wire | | | Drawer |
| | | | | | DIP | | SMT | | | | | | | | |
| Vertical type | Horizontal type | Vertical type | Horizontal type | | | | | | | | | | | | |
| 1000 (P.10 - 25) |  | 1100S | Standard | - | - | 0 | - | - | - | - | - | - | - | - | 4,8,10 |
| | | 1100D | Standard | 0 | 0 | 0 | 0 | - | 0 | - | - | - | - | - | 10,20,22,26,28,30,32,34,40 |
| | | 1200S | High Voltage | 0 | 0 | - | - | - | - | - | - | - | - | - | 2 |
| | | 1200D | High Voltage | 0 | 0 | 0 | - | - | 0 | - | - | - | - | - | 4,6,8,10,12,16,20 |
| | | 1500T | Module Type | - | 0 | 0 | - | - | 0 | 0 | - | 0 | - | - | 3,6,9,10,12,34,36 |
| | | 1900D | Spring Clamp Type | - | 0 | 0 | - | - | - | - | - | - | - | - | 8,12,22,30,38 |
| 2000 (P.26-34, P.60-67, P.95-97) |  | 2100S | Standard | 0 | 0 | 0 | - | - | 0 | - | - | - | - | 3 | |
| | | 2100D | Standard | 0 | 0 | 0 | - | - | 0 | - | - | - | - | 6,8,12,16,20 | |
| | | 2100M | Multiposition Drawer | 0 | - | 0 | - | - | 0 | - | - | - | 0 | - | 50 |
| | | 2600D | Hybrid Power/Signal | - | 0 | - | - | - | - | - | - | - | - | - | 48 |
| | | 2800 | Multi-Frame | 0 | - | - | - | - | 0 | - | - | - | - | - | 30 |
| | | 2950 | Spring Clamp Type | - | - | 0 | - | - | - | - | - | - | - | - | 5,6 |
| | | 2970 | On-Site Push-In Type | - | - | - | - | 0 | - | - | - | - | - | - | 3,4 |
| 3000 (P.35-70, P.95-97) |  | 3100S | Standard & SMT | 0 | 0 | 0 | 0 | 0 | 0 | - | - | - | - | 3,4,5,6,8,10 | |
| | | 3100D | Standard | 0 | 0 | 0 | - | - | 0 | - | - | - | - | 6,8,10,12,16,20 | |
| | | 3100M | Module Type | - | 0 | 0 | - | - | - | - | - | - | - | 6 | |
| | | 3200S | High Voltage | 0 | 0 | 0 | - | - | 0 | - | - | - | - | 2,3,4,5,6 | |
| | | 3200M | High Voltage | 0 | 0 | 0 | - | - | 0 | - | - | - | 0 | 6,10,12,20 | |
| | | 3200FMLB | Sequential type | - | - | 0 | - | - | - | - | - | - | - | 4,12 | |
| | | 3200T | High Voltage | - | - | 0 | - | - | - | - | - | - | - | 9 | |
| | | 3400F | Skyscraper | - | - | 0 | - | - | - | - | - | - | - | - | 12,20 |
| | | 3500D | Modular Type | 0 | 0 | 0 | - | - | 0 | - | - | - | - | - | 2,4,6,12,20 |
| | | 3800 | Multi-Frame | 0 | - | - | - | - | 0 | - | - | - | - | - | 12 |
| | | 3100/3200 | Dynatap | - | - | - | - | - | - | - | 0 | - | - | - | 18,24 |
| 3950 | Spring Clamp Type | - | - | 0 | - | - | - | - | - | - | - | - | 2,3,4,6,7,8,11 | | |
| 4000 (P.71-77, P.60-64, P.95-97) |  | 4200S | Standard | 0 | 0 | 0 | - | - | 0 | - | - | - | - | 2,3,4 | |
| | | 4200M | Module Type | 0 | - | - | - | - | 0 | - | - | - | - | 6 | |
| | | 4800 | Multi-Frame | 0 | - | - | - | - | 0 | - | - | - | - | 8 | |
| | | 4950 | Spring Clamp Type | - | - | 0 | - | - | - | - | - | - | - | 8 | |
| 5000 (P.78-97) |  | 5200S | Standard | 0 | 0 | 0 | - | - | 0 | - | - | - | - | 2,3,4,6 | |
| | | 5200M | High Voltage | 0 | 0 | 0 | - | - | 0 | - | - | - | - | 4,6,8 | |
| | | 5300S | Reversed Housing | - | - | - | - | - | 0 | - | - | - | - | 3 | |
| | | 5300D | Reversed Housing | - | - | - | - | - | 0 | - | - | - | - | 4 | |
| | | 5200 | Dynatap | - | - | - | - | - | - | 0 | 0 | - | - | 12,20 | |
| | | | Dyna-Clamp kit | 0 | 0 | 0 | - | - | 0 | - | - | - | - | 3,4 | |
| | | D5200Mα | High Current | - | - | 0 | - | - | - | - | - | - | - | 4 | |
| | | DZ-5200 | Board-to-Board type | - | - | - | - | - | - | - | - | - | 0 | 5,7 | |
| | | | | - | - | - | - | - | - | - | - | - | 0 | 3,4 | |
| 5800 | Multi-Frame | 0 | - | - | - | - | 0 | - | - | - | - | 4 | | | |
| 7000 (P.98-103) |  | 7100 | Standard | 0 | - | 0 | - | - | 0 | - | - | - | - | 4 | |
| | | 7300 | Reversed Housing | 0 | - | 0 | - | - | 0 | - | - | - | - | 4 | |
| | | | Dyna-Clamp kit | 0 | - | - | - | - | - | - | - | - | - | 4 | |
| Other products | | | Multiple Enclosure Connector | | | | | | 0 | | | | | 15,24,32 | |

| | | | Electrical Performance | | | | Safety Standards | | Corresponding Pages | |
|----------------|----------------------------|-----------------------------|---|---------------------------|--------------------------|----------------------------------|---|----------|---------------------|-------|
| Number of Rows | Pitch (mm) | Wire Range (AWG) | Maximum rated current (A) | Maximum Rated voltage (V) | Withstanding Voltage (V) | Durability (Cycles) | UL CSA TÜV | IP Level | | |
| 1 | 2.0 | 30-22 | 3 | 125 | 700 | Gold: 50 Tin: 30 | UL : File No. E28476 CSA : Report No. LR7189 TÜV : License No. R50085096 | | 14 | |
| 2 | 2.0 | 30 - 22 | 3 | 125 | 700 | | | | 15 - 17 | |
| 1 | 2.5 | 30 - 18 | 5 | 250 | 1100 | | | | 18 | |
| 2 | | | | | | | | | 19 - 21 | |
| 3,4 | 3.5 | | | | | | | | 22 - 24 | |
| 2 | 3.5 | 24 - 18 | 4 | 150 | 1100 | | UL 1059 E60677 | 25 | | |
| 1 | 2.5 | 28 - 18 | 5 | 250 | 1500 | 500 | UL : File No. E28476 CSA : Report No. LR7189 TÜV : License No. R9950679 | | 30 | |
| 2 | | | | | | | | | 31 - 32 | |
| 2 | | 20 | 2.6 | | | | | 33 | | |
| 3 | D-2(2.5) D-3(3.81) | D-2(28 - 18) D-3(28 -14) | D-2(3.2) D-3(7.5) | 250 | 1500 | 500 | UL : File No. E28476 CSA : Report No. LR7189 TÜV : License No. R9950679 | | 34 | |
| 6 | 3.75 | 28 - 18 | 5 | | | | | | | 95-97 |
| 1 | 5.08 | 18 - 14 | 10 | 600 | 2200 | Gold: 500 | UL : 1059 | | 60-62 | |
| 1 | 5.0 | 24 - 14 | 10(UL)/20(IEC) | 300(UL)/400(IEC) | 2210 | Gold: 100; tin: 25 | UL:1059 IEC:61984/90647-7-1 | | 65-67 | |
| 1 | 3.81 | 28 - 14 | 15 | 250 | 1500 | Gold: 500 Tin: 100 | UL : File No. E28476 CSA : Report No. LR7189 TÜV : License No. R50084673 (VDE0627) | | 40-43 | |
| 2 | 3.81 | | | | | | | | 44-45 | |
| 2 | 3.81 | | | | | | | | 46 | |
| 1 | 5.08 | | | | 47-49 | | | | | |
| 2 | 5.08 | | | | 50-54 | | | | | |
| 2 | 5.08 | | | | 55 | | | | | |
| 3 | 5.08 | | | | 56 | | | | | |
| 4 | 3.81 | | | | 57 | | | | | |
| 2 | 5.08 | | | | 58-59 | | | | | |
| 4 | 6.5 | | | | 95-97 | | | | | |
| 3,6 | 3.81 | | | 28 - 14 | 15 | | | 250 | 1500 | |
| 1,2 | 7.5 | 22-14 | 14.5 | 600 | 2200 | Gold: 500 | UL : 1059 | | 63 | |
| 1 | 6.35 | 16 - 12 | 24 | 600 | 2500 | 25 | UL : File No. E28476 CSA : Report No. LR7189 TÜV : License No. R50084673 | | 75-76 | |
| 2 | 6.35 | | 24 | 600 | 2500 | | | | 77 | |
| 4 | 6.35 | | 24 | 600 | 2500 | | | | 95-97 | |
| 1 | 7.5 | 16 - 10 | 22 | 600 | 3310 | Gold: 500 | UL : 1059 | | 64 | |
| 1 | 10.16 | 16 - 10 | 30 | 630 | 3000 | 0.76µ gold: 50 0.38µ gold: 25 | UL : File No. E28476 CSA : Report No. LR7189 TÜV : License No. R9650368 | 10 | 82-83 | |
| 2 | | | | | | | | | 10 | 84-85 |
| 1 | | | | | | | | | 20 | 86 |
| 2 | | | 20 | | | | | | | |
| 3 | | | | | 87 | | | | | |
| 1 | | 16 - 10 | 30 | | | 0.76µ gold: 50 0.38µ gold: 25 | | | 88-89 | |
| 2 | | 20 - 8 | 45 | | | Silver: 25 | UL : File No. E28476 CSA : Report No. LR7189 TÜV : License No. R9650368 | 10 | 90-91 | |
| 1 | 5.08 | - | 20 | 250 | 2200 | 15 | UL : File No. E28476 CSA : Report No. LR7189 TÜV : License No. R50073218 | | 92-93 | |
| | 10.16 | | 30 | 600 | 4000 | | | | | |
| 2 | 12.0 | 16 - 10 | 30 | 630 | 3000 | 0.76µ gold: 50 0.38µ gold: 25 | UL : File No. E28476 CSA : Report No. LR7189 | 10 | 95-97 | |
| 2 | 16 | 16 - 6 | 60 (board-to-wire) 65 (wire-to-wire) 55 (wire-to-wire cable clamp type) | 630 | 3000 | 0.76µ gold: 20 | UL : File No. E28476 TÜV : License No. R9650368 | | 101 | |
| 2 | 16 | 16 - 6 | | | | | | | 102 | |
| 2 | 16 | - | | | | | | | 103 | |
| 4,8 | See details in series page | | See details in series page | | | | See details in series page | | 104-106 | |

Contact Features (Example of the D-3000 Series)

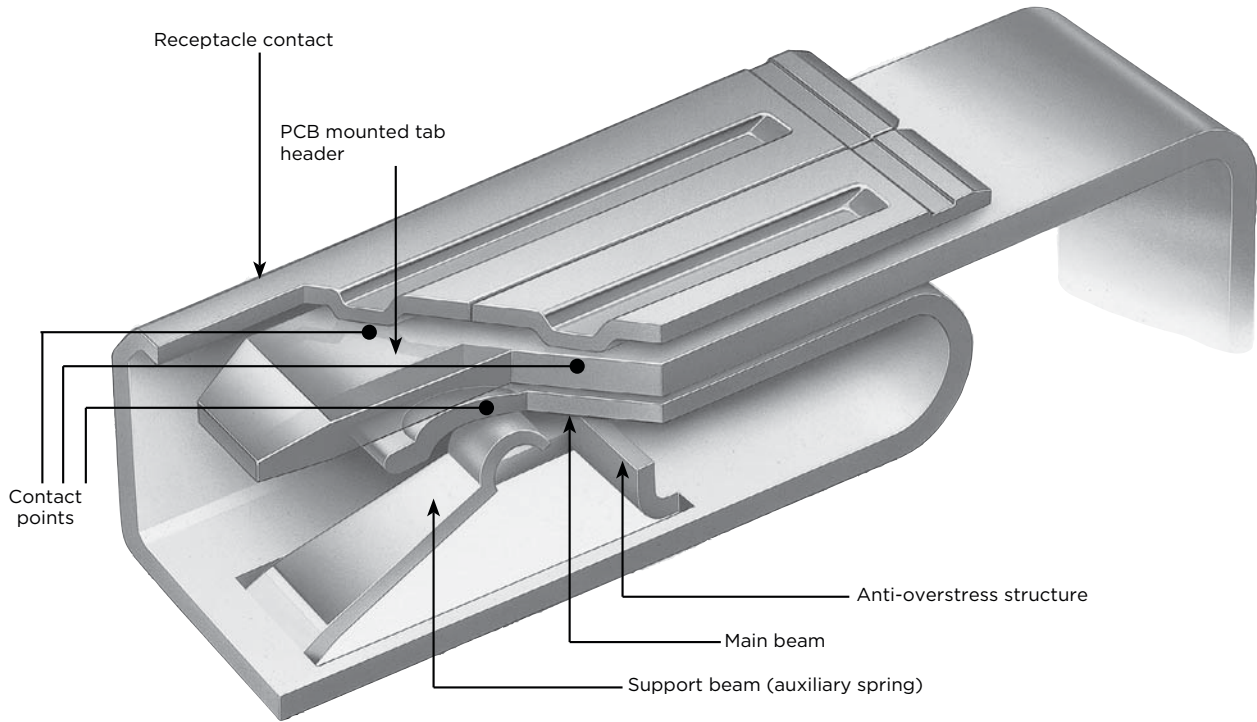

(Illustration of the D-3 Connector)

Contact Pressure Adjustment Method

- Gold and Tin contacts are available. Adjustable gaps for the auxiliary spring (at positions of A-C) to get the optimum contact pressure. For gold-plated product, both high pressure contact and standard pressure contact are available in accordance with the intended use
- Anti-overstress structure prevents damage to the main beam which might be caused by insertion of external objects or twisting (Receptacle contact type of D-2 S, M/D-3 S, M, L, 2L, 3L/D-5 S, M)

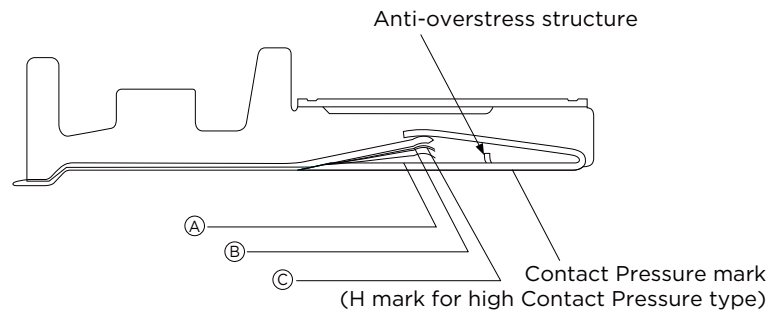

(Applicable to the D-3 terminal)

| Plating | Type | Contact Pressure | Position | Contact Pressure Mark | Applicable Positions | Specifications | Application | Durability (cycles) |
|---------|---------------------------|------------------|----------|-----------------------|----------------------|--------------------------|---|---------------------|
| Gold | Standard Contact Pressure | Around 1.47N | (A) | — | 1-100 | Standard | Used for signal/power multi-position and High durability cycles circuits | 500 |
| | High Contact Pressure | Around 2.45N | (B) | H | 1-20 | Vibration / High current | Used for signal/Power supply/ Motor application with high-vibration feature | 500 |
| Tin | High Contact Pressure | Around 3.92N | (C) | H | 1-10 | High Current | Used for Signal/Power supply circuit with few durability cycles | 100 |

Contact Features (Example of the D-3000 Series)

Tab/Receptacle Contact

Male side is tab, while female side is receptacle contact so as to avoid twisting. (Refer to Figure below) Highly reliable 3-point contacts are used.

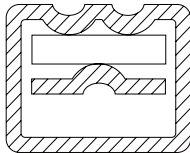

Fixing of the contact and housing

The housing lance is used to secure the contact in place. The lance ensures the contact stays secure in the housing and helps prevent damage during contact mating. In addition to these protective features, the housing lance produces an audible “click” ensuring the contact is securely locked in the housing. The contact can still be easily removed with extraction tool.

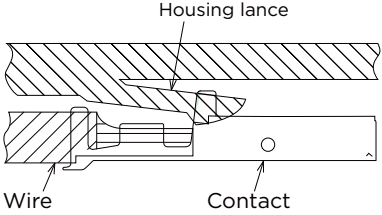

Confirmation Marks

- Contact Pressure marks.....“H” mark on the bottom of the contact for high pressure contact product (standard pressure contact for those without the marks)
(Only for D-3 connector)

- Plating marks.....To show clearly types and thickness of the plating. Following numbers will be marked on the side surface of the contact. This number is consistent with the additional number of contact’s part model number.
-2.....Gold plating of 0.38µm in thickness
-3.....Gold plating of 0.76µm in thickness
-5.....Tin plating

- Marking both contact series (D-1/D-2/D-3/ D-4/D-5) and wire range (SS,S,M,L) on side surface of contact aim to avoid misuse of hand tools and extraction tools.

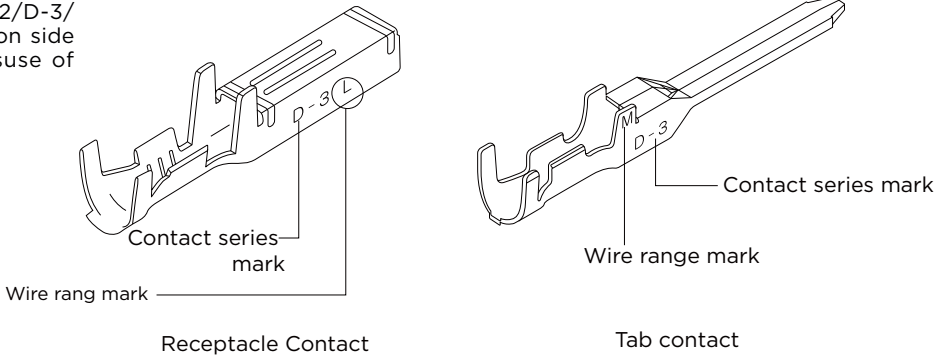
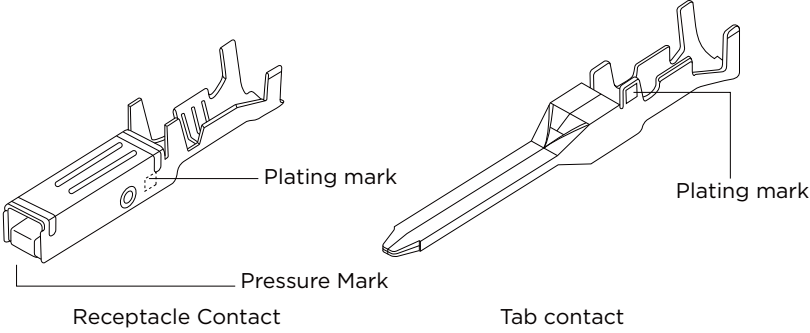

Wire range marks

| | | |
|---------|----|----------------|
| D-1 | S |AWG#30-28 |
| | M |AWG#28-22 |
| | L |AWG#28-22 |
| | 2L |AWG#22-18 |
| D-2 | S |AWG#28-24 |
| | M |AWG#22-18 |
| D-3 | S |AWG#28-24 |
| | M |AWG#24-20 |
| | L |AWG#20-16 |
| | 2L |AWG#16-14 |
| | 3L |AWG#16-14 |
| D-4 | M |AWG#16-14 |
| | L |AWG#14-12 |
| D-5/D5α | SS |AWG#20-16 |
| | S |AWG#16-14 |
| | M |AWG#12-10 |
| | L |AWG#8 |

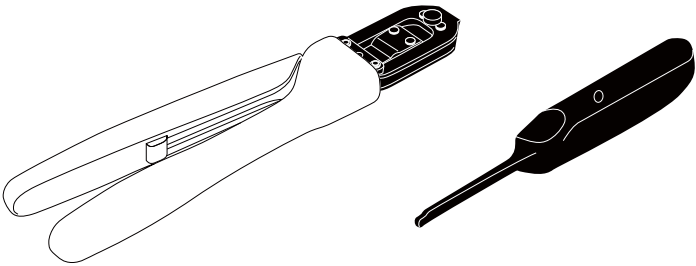

Hand tool Extraction

Housing Features (Example of the D-3000 Series)

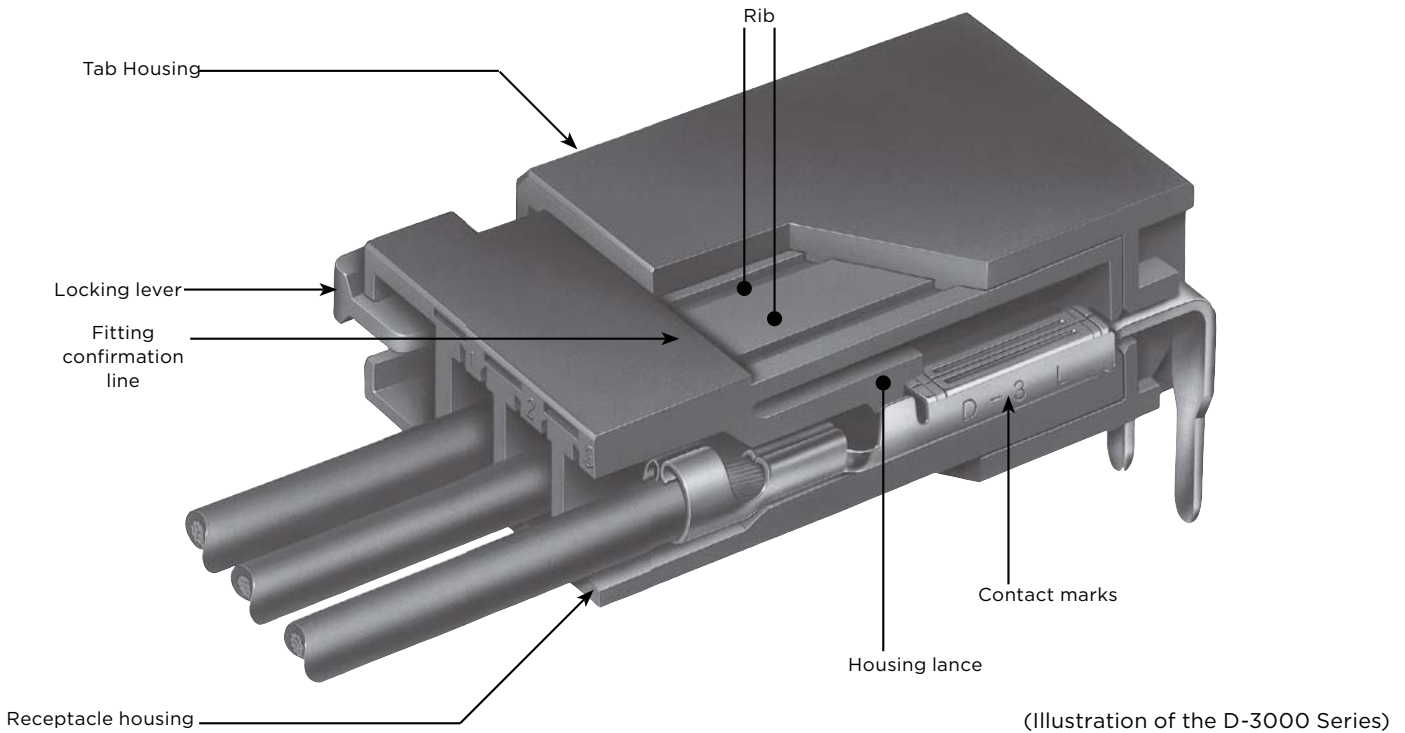

Easy to insert and extract the connector

- When you insert or extract the connector, a clear “click” sound will be heard. A fitting confirmation line is provided to confirm the operation
- Pinch 2 locking levers on both sides of the housing to easily extract the receptacle side (D -3100/D-3200/ D-4000/D-5200 Series)

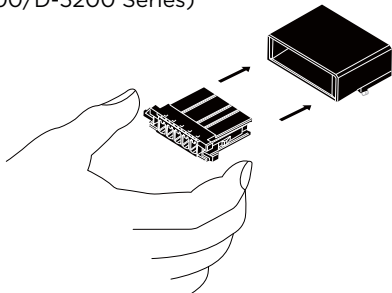

- For safety consideration, well rounded corners will be used to prevent hand injuries when inserting or extracting the connector

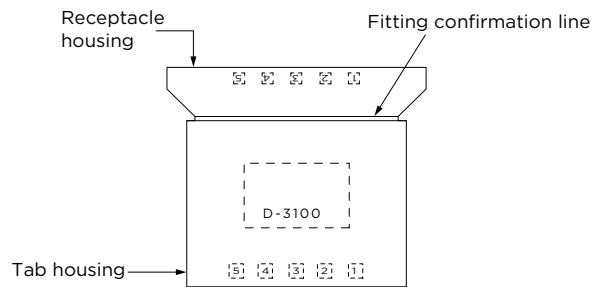

Vertical - type header

- To avoid mis-installation or mis-alignment of the Header on board, pay attention to direction indicator (Concave) of Vertical-type header (only available for D-3000 Series)

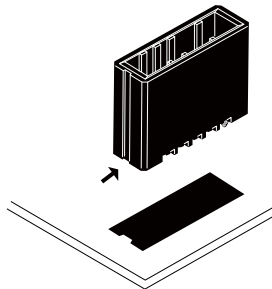

Housing to protect Tin-plated contacts

- For protecting the soldering Tin-plated contacts, Housing of horizontal type of Header will be fully applied to cover contacts.

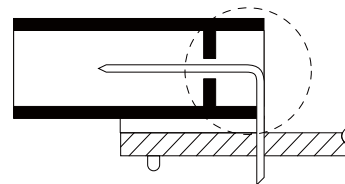

Housing Features (Example of the D-3000 Series)

Retention legs for board mounting

- For robotic automatic implementation, the retention legs will be provided for both the vertical-type and the horizontal-type headers.

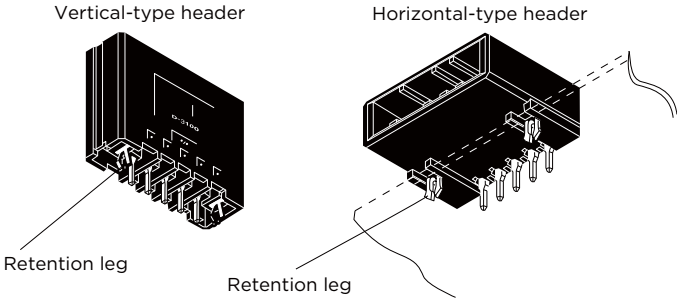

Note: The fixing pins are of the same thickness as the 1.6mm thickness circuit board. When they are used for a 2.4mm thickness circuit board, the strength will decrease somewhat.

- Especially for the horizontal-type header, it is possible to mount to the bottom of the housing and it will not take up as wide a space as the conventional system. Retention legs are close to the insertion part of the receptacle housing so as to resist tilting caused by the cable (Patent number 2,508,076).

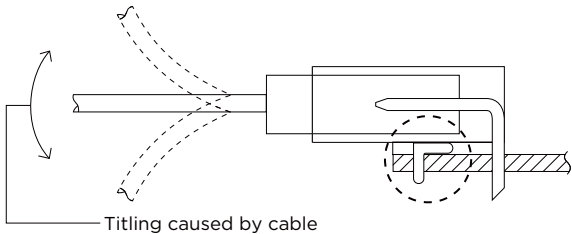

Twisting Prevention Structure

- The ribs are used in both receptacle housing and tab housing. This safety design can be used to avoid any backlashes between housings after the receptacle housing has been completely inserted into tab housing.

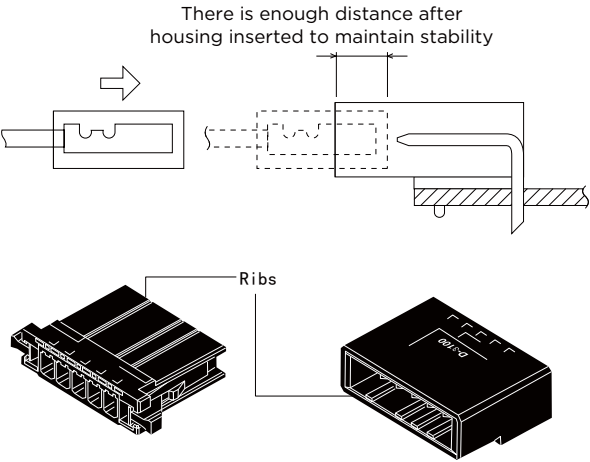

Anti-mis-plugging structure

- Part of the products (D-1200D/ D-2100/ D-2100D/ D-3100/ D-3100M/ D-3200/ D-3200M/D-3200T/ D-4000/ D-5200/ D-5200M) is provided with keying to prevent incorrect insertion. By using this plug, it also makes it easier to prevent incorrect insertion of other items. (refer to page 107, which shows the information of keying plugs)

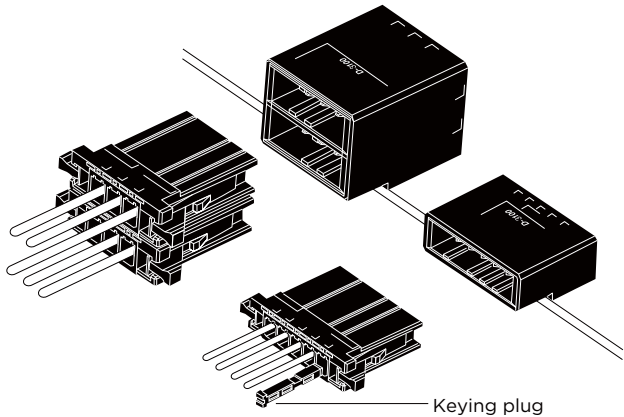

Label Mark

- A flat side portion is provided in the housing for custom labels.

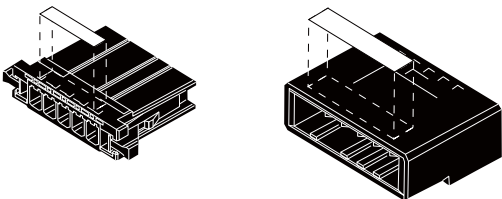

Easy-to-read circuit number

- To facilitate cable assembly, tab and receptacle housings will be marked with circuit numbers.

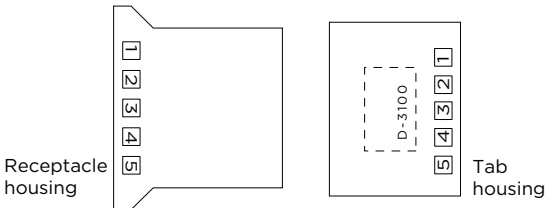

Guideline for plating selection(These guidelines apply to the D-3000 series only. Please note that they may not be suitable for other products.)

Whether to use gold or tin plating depends on the voltage, current, environment (vibration, temperature, gas, etc.), number of contact positions, and other variables.

Gold plating is recommended for general industrial machinery, but in reality cost considerations are also a factor. To help in this selection, these guidelines have been put together for Dynamic Series as a reference in the selection process.

(1) Selection based on voltage and current

| | Gold Plated | Undetermined zone | Tin | No Plating (Reference) |
|---------|-------------|-------------------|------------|------------------------|
| Voltage | Below 3 V | 3 to 30 V | 30 - 100 V | Over 100 V |
| Current | Below 1 A | 1 to 10 A | Over 10 A | Over 0.1 A |

(Table 1)

Table 1 shows us that gold should always be used for applications under 3 volts and 1 ampere. When the voltage is over 30 and amperage is over 10, tin plating can be used. The most difficult area to make a selection is in the undetermined zone. In this zone either gold or tin plating can be used, and environmental parameters are the key variation to consider

due to extensive impact on the application.

In a clean environment tin plating is acceptable. However, use gold plating if the environment is harsh, such as high heat or humidity, the presence of gas is possible, vibration is extreme, mating and demating are frequent, or other factors.

(2) Selection based on number of contact positions (selection based on contact pressure)

Selecting based on the number of contact positions is often forgotten. The higher the contact pressure the more possible it is to use tin plating or no plating, regardless of the voltage or current mentioned in section 1. However, if pressure is too high, mating and demating become impossible so the connector function is lost. To get around this, we can drive the voltage and current down into a workable zone, but then we run into the problem of oxidation. To prevent oxidation, we use tin (approximately 2.94 N optimum contact pressure) or gold (approximately 1.18 N) plating. Even though, the contact pressure increases proportionally as we increase the number of contact positions, which causing difficult mating and demating. Generally speaking, given a 39.2 N limit for mating/demating by hand, it becomes difficult without using leverage,

such as a lever or jack screw when exceed the limit.

The Dynamic D-3000 series has a maximum of 20 contact positions. The contact pressure per pin with tin plating is 3.92 N, and with gold plating is 2.45 N and 1.47 N (high pressure types and standard types are available for some applications).

For instance, given 3.92 N for tin plating, the insertion and extraction force of 20-position connector will be 58.8N and 49.0N, which is difficult because it exceeds the range for barehanded work. Therefore, gold plating are selected when position increased regardless of the voltage and current conditions mentioned in section 1.

Table 2 shows the applicable maximum number of contact positions as a reference.

| Contact Pressure | | Applicable Maximum Number of Contact Positions |
|--|-------|--|
| (1)Gold Standard contact pressure parts: | 1.47N | 20 |
| (2)Gold High contact pressure parts: | 2.45N | 20 |
| (3)Tin High contact pressure parts: | 3.92N | 12 |

(Table - 2) Note: Insertion force and extraction force are not the same as contact pressure.

(3) Environment (vibration, humidity, gas, etc.)

Although the environment was discussed in section 1 about voltage and current, it is summarized again here. Use gold plating in a harsh environment, particularly for high vibration or heat, the presence of gas or other harsh conditions. Gold is a noble metal and does not react easily with other materials which means good resistance to oxidation. This is a very important property for contacts.

Also, if vibration is an issue, there is the risk of fretting corrosion (micro-abrasion). Gold plating is always the recommended choice.



Guideline for plating selection (These guidelines apply to the D-3000 series only. Please note that they may not be suitable for other products.)

(4) Others considerations

- Contact between dissimilar metals

Strongly recommend to match contacts with same plating materials. For example, gold-plated receptacle contact mate with gold-plated tab contact or header. That's because different plating materials may create a lot of ionization and electrolytes which lead to corrosion, therefore the performance of product will be worse than a pair of connectors with same plating.

- Being consistent within an application

We recommend that, as much as possible, the same type of plating be used within one application. This is to prevent connections being made between dissimilar metals, gold and tin as mentioned on the left, during assembly and maintenance. And for the same reason, we recommend using the same plating in factories or workplaces where assembly or harness production is done.

The above information has been summarized in "Plating selection at a glance" for your convenience.

- ★★★ Best
- ★★ Good
- ★ Usable
- Unacceptable

Platings selection at a glance

| Voltage/Current | Application | Tin plated | Gold Plated | | | |
|----------------------|-------------------------------|------------|-------------------|---------------|-------------------|---------------|
| | | | 0.38μ | | 0.76μ | |
| | | | Standard pressure | High pressure | Standard pressure | High pressure |
| Below 3V Below 1A | Standard specifications | - | ★★ | ★★ | ★★★ | ★★★ |
| | Vibration | - | ★ | ★★ | ★ | ★★★ |
| | Harsh environment | - | ★ | ★ | ★★ | ★★★ |
| | Extensive mating/ unmating | - | ★★ | ★ | ★★★ | ★★ |
| | Many contact positions | - | ★★★ | ★★ | ★★★ | ★★ |
| 3 to 30V 1 to 10A | Standard specifications | - | ★★ | ★★ | ★★★ | ★★★ |
| | Vibration | - | ★ | ★★ | ★ | ★★★ |
| | Harsh environment | - | ★★ | ★★ | ★★★ | ★★★ |
| | Extensive mating/ unmating | - | ★★ | ★ | ★★★ | ★★ |
| | Many contact positions | - | ★★★ | ★★ | ★★★ | ★★ |
| Over 3V Over 1A | Standard specifications | ★★ | ★★★ | ★★★ | ★★★ | ★★★ |
| | Vibration | - | ★★ | ★★★ | ★★ | ★★★ |
| | Harsh environment | - | ★★ | ★★ | ★★★ | ★★★ |
| | Extensive mating/ unmating | - | ★★★ | ★★ | ★★★ | ★★ |
| | Many contact positions | - | ★★★ | ★★ | ★★★ | ★★ |

The above table is based on industrial equipment with sufficient margin reserved. There are various combinations depending on the application, so it is not necessarily as shown in the above table, which is for reference only.

D-1000 Series

Series introduction

D-1000 Series are the smallest connectors for signal lines among all the Dynamic connector series.

The Dynamic 1000 Series consists of 3 different pitch sizes: 2.0mm standard type, 2.5mm high-voltage type and 3.5mm type.

D-1000 Series has gold plated contacts to maintain its high reliability and also tin plated contacts for economical market needs. Customers can choose their own contacts according to specifications, applications and cost.

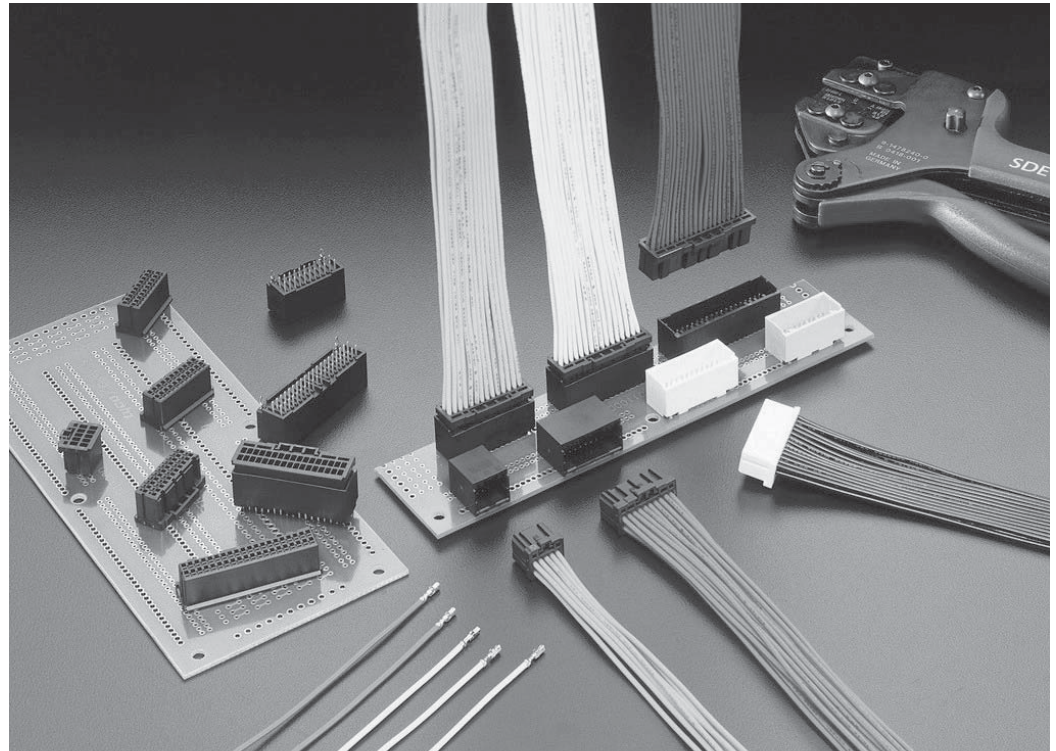

Product Features

1. Wide Applicable Wire

From D-1000 series has wide applicable wire range of 30 AWG to 18 AWG with maximum 2.2 mm of outside diameter (D-1200/ D-1500). Therefore there are no special safety considerations using it in electrical cabinets.

2. Hand Tools are available for all wire sizes.

It can save on delivery lead time and minimize installation tooling costs.

3. Housing and Contact Features

A) Housing products

The D-1000 series consists of D-1100 series with 2.0mm pitch center line, D-1200 series with 2.5mm pitch center line. In addition, the D-1500 series and D-1900 series have a pitch of 3.5mm

B) Contact Products

D-1000 series provide gold plating contact as standard products and also tin plating contact for economical market needs. Choose contact according to specifications, application, quality level and cost.

4. Other Features (Basic Dynamic series features)

- Header connector and tab connector have enough length from the tip of contact to top of its housing. To prevent contact from bending during mating
- D-1000 series are provided with housing lance structure
- Clear identification of circuit number helps with correct wiring
- Metal retention leg on header prevents unwanted movement from cable tension
- Housing lock design avoid wire scratching

Note: All models are RoHS compliant.

D-1000 Series Performance and Specifications

Performance

| Item \ series | D-1100 | D-1200 | D-1500 | D-1900 |
|-----------------------|-------------------------|---------------------------|---------------------------|-------------------------|
| Pitch | 2.0mm | 2.5mm | 3.5mm | 3.5mm |
| Rated voltage | 125V AC/DC | 250V AC/DC | 250V AC/DC | 150V AC/DC |
| Rated current (Max) | 1 pos: 3A With AWG22 | 1 pos: 5A (With AWG18) | 1 pos: 5A (With AWG18) | 1 pos: 4A With AWG18 |
| Contact resistance | 20m Ω Max | | | 40mΩ Max |
| Withstanding Voltage | 1,000V AC | 1,500V AC | 1,500V AC | 1,100V AC |
| Operation Temperature | -55°C ~+105°C | | | -30°C ~+105°C |

Positions/ wire size / rated current

D-1100-1500 series

| Position | Wire Size (AWG) | | | | | | |
|----------|-----------------|-----|-----|-----|-----|-----|-----|
| | 18 | 20 | 22 | 24 | 26 | 28 | 30 |
| 1 | 5 | 4 | 3 | 2.5 | 2 | 1.5 | 1 |
| 2-20 | 3.5 | 2.7 | 2.5 | 2 | 1.5 | 1 | 0.8 |
| 21-40 | - | - | 2 | 1.5 | 1 | 0.8 | 0.5 |

D-1900 series

| Position | Wire Size (AWG) | | | |
|----------|-----------------|-----|-----|-----|
| | 18 | 20 | 22 | 24 |
| 8-12 | 3 | 2 | 1.5 | 1 |
| 13-38 | 2 | 1.5 | 1 | 0.5 |

Product Specifications

| | | |
|---|------------------------|-----------------------------------|
| Product Specifications | | 108-78268 (gold-plated) |
| | | 108-78298 (Tin-plated) |
| | | 108-78336 (D-1900) |
| Applications Specifications | | 114-5377 (D-1100, D-1200, D-1500) |
| | | 411-78291(D-1900) |
| Crimping tool instruction sheet | Part number: 1762952-1 | 408-10414-JPN |
| | Part number: 1762846-1 | |
| | Part number: 1762950-1 | |
| | Part number: 1762625-1 | |
| Extraction tool part number: 1891526-1 D-1900 Extraction tool part number: 1891348-1 | | 411-78241 411-78263 |

Materials and Plating

| Description | Material | Finish |
|------------------------------------|---|--|
| Receptacle Contacts Tab Contact | Copper alloy | Tin-plating or 0.38µm gold-plating over 1.27µm Nickel under-plated |
| Board Mount Header | Copper alloy | 0.38 µm gold-plating over 1.27 µm Nickel under-plated 2.0 µm Tin-plating on tail side |
| Housing | UL94V-0, Thermoplastic PBT containing glass fiber | |

Safety Standards *Remember to obtain Instruction Sheets when you choose to use these tools. You can get electronic catalogue pages or instruction sheets on the Internet.

The safety specifications listed below are approved on specific part numbers. Please contact our Technical Support Centre to check whether the part numbers you use are approved or not. Keep in mind that there are instances where values differ from those given by Tyco Electronics Specifications.

| series \ Specifications | D-1100 | | | D-1200, D-1500 | | | D-1900 | | | | | | | | | | | | | | | | | | | | | | | | | | | | | | | | | | | | | | | | |
|----------------------------------|--------------------------------------|--|-------------------|--------------------------------------|--------------------------------------|-------------------|--------------------------------------|--------------------------------------|-------------------|---|----|-----|----|---|---------------|------------|--|-----|----------|----|---|----|---|----|---|----|-----|----|---|----|-----|----|---|---------------|------------|---|-----|----------|----|---|----|---|----|-----|----|---|---------------|
| | Rated Voltage | Rated Current | Temperature Range | Rated Voltage | Rated Current | Temperature Range | Rated Voltage | Rated Current | Temperature Range | | | | | | | | | | | | | | | | | | | | | | | | | | | | | | | | | | | | | | |
| Product Specifications 108-78268 | 125V AC/DC | 3A (1 pos) | -55°C ~+105°C | 250V AC/DC | 5A (1 pos) | -55°C ~+105°C | 150V AC/DC | 4A (1 pos) | -30°C ~+105°C | | | | | | | | | | | | | | | | | | | | | | | | | | | | | | | | | | | | | | |
| UL File No.E28476 | Based on requirements of Application | Based on requirements of Application | - | Based on requirements of Application | Based on requirements of Application | - | Based on requirements of Application | Based on requirements of Application | - | | | | | | | | | | | | | | | | | | | | | | | | | | | | | | | | | | | | | | |
| CSA Report No.LR7189 | 125V AC/DC | 3A | — | 250V AC/DC | 5A | — | 150V AC/DC | 4A (1 pos) | — | | | | | | | | | | | | | | | | | | | | | | | | | | | | | | | | | | | | | | |
| TÜV | 125V AC/DC | <table border="1"> <thead> <tr> <th>AWG</th> <th>A (1pos)</th> </tr> </thead> <tbody> <tr><td>22</td><td>3</td></tr> <tr><td>24</td><td>2.5</td></tr> <tr><td>26</td><td>2</td></tr> <tr><td>28</td><td>1.5</td></tr> <tr><td>30</td><td>1</td></tr> </tbody> </table> | AWG | A (1pos) | 22 | 3 | 24 | 2.5 | 26 | 2 | 28 | 1.5 | 30 | 1 | -55°C ~+105°C | 250V AC/DC | <table border="1"> <thead> <tr> <th>AWG</th> <th>A (1pos)</th> </tr> </thead> <tbody> <tr><td>18</td><td>5</td></tr> <tr><td>20</td><td>4</td></tr> <tr><td>22</td><td>3</td></tr> <tr><td>24</td><td>2.5</td></tr> <tr><td>26</td><td>2</td></tr> <tr><td>28</td><td>1.5</td></tr> <tr><td>30</td><td>1</td></tr> </tbody> </table> | AWG | A (1pos) | 18 | 5 | 20 | 4 | 22 | 3 | 24 | 2.5 | 26 | 2 | 28 | 1.5 | 30 | 1 | -55°C ~+105°C | 150V AC/DC | <table border="1"> <thead> <tr> <th>AWG</th> <th>A (1pos)</th> </tr> </thead> <tbody> <tr><td>18</td><td>4</td></tr> <tr><td>20</td><td>3</td></tr> <tr><td>22</td><td>2.5</td></tr> <tr><td>24</td><td>2</td></tr> </tbody> </table> | AWG | A (1pos) | 18 | 4 | 20 | 3 | 22 | 2.5 | 24 | 2 | -30°C ~+105°C |
| AWG | A (1pos) | | | | | | | | | | | | | | | | | | | | | | | | | | | | | | | | | | | | | | | | | | | | | | |
| 22 | 3 | | | | | | | | | | | | | | | | | | | | | | | | | | | | | | | | | | | | | | | | | | | | | | |
| 24 | 2.5 | | | | | | | | | | | | | | | | | | | | | | | | | | | | | | | | | | | | | | | | | | | | | | |
| 26 | 2 | | | | | | | | | | | | | | | | | | | | | | | | | | | | | | | | | | | | | | | | | | | | | | |
| 28 | 1.5 | | | | | | | | | | | | | | | | | | | | | | | | | | | | | | | | | | | | | | | | | | | | | | |
| 30 | 1 | | | | | | | | | | | | | | | | | | | | | | | | | | | | | | | | | | | | | | | | | | | | | | |
| AWG | A (1pos) | | | | | | | | | | | | | | | | | | | | | | | | | | | | | | | | | | | | | | | | | | | | | | |
| 18 | 5 | | | | | | | | | | | | | | | | | | | | | | | | | | | | | | | | | | | | | | | | | | | | | | |
| 20 | 4 | | | | | | | | | | | | | | | | | | | | | | | | | | | | | | | | | | | | | | | | | | | | | | |
| 22 | 3 | | | | | | | | | | | | | | | | | | | | | | | | | | | | | | | | | | | | | | | | | | | | | | |
| 24 | 2.5 | | | | | | | | | | | | | | | | | | | | | | | | | | | | | | | | | | | | | | | | | | | | | | |
| 26 | 2 | | | | | | | | | | | | | | | | | | | | | | | | | | | | | | | | | | | | | | | | | | | | | | |
| 28 | 1.5 | | | | | | | | | | | | | | | | | | | | | | | | | | | | | | | | | | | | | | | | | | | | | | |
| 30 | 1 | | | | | | | | | | | | | | | | | | | | | | | | | | | | | | | | | | | | | | | | | | | | | | |
| AWG | A (1pos) | | | | | | | | | | | | | | | | | | | | | | | | | | | | | | | | | | | | | | | | | | | | | | |
| 18 | 4 | | | | | | | | | | | | | | | | | | | | | | | | | | | | | | | | | | | | | | | | | | | | | | |
| 20 | 3 | | | | | | | | | | | | | | | | | | | | | | | | | | | | | | | | | | | | | | | | | | | | | | |
| 22 | 2.5 | | | | | | | | | | | | | | | | | | | | | | | | | | | | | | | | | | | | | | | | | | | | | | |
| 24 | 2 | | | | | | | | | | | | | | | | | | | | | | | | | | | | | | | | | | | | | | | | | | | | | | |

Some part numbers are not available yet. Please contact our Sales Department for more information.

D-1000 Series Configurations

D-1100S Single-row Type

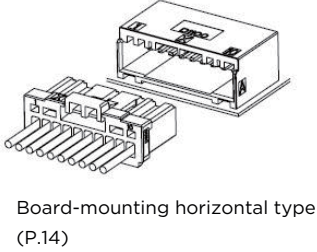

D-1100D Double-row Type

D-1100D Board-mounting horizontal type (P.15)

D-1100D Receptacle housing (P.15)

D-1100D Free Hanging type (P.15)

D-1100D Board-mounting vertical type (P.15)

D-1100D Panel type (P.15)

D-1100D Receptacle housing (P.15)

D-1200D Double-row Type

D-1200D Board-mounting horizontal type (P.19)

D-1200D Receptacle housing (P.19)

D-1200D Free Hanging type (P.19)

D-1200D Panel type (P.19)

D-1200D Board-mounting horizontal type (P.19)

D-1200D Receptacle housing (P.19)

D-1200S Single-Row Type

D-1200S Receptacle housing (P.18)

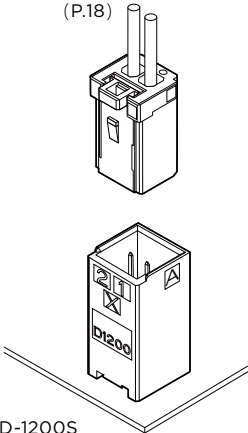

D-1200S Free Hanging type (P.18)

D-1200S Receptacle housing (P.18)

D-1500T Board-mounting horizontal type (P.22)

D-1500T Receptacle housing (P.22)

D-1500T Triple-row Type

D-1500T Receptacle housing (P.22)

D-1500T Board-mounting vertical type (P.22)

D-1500T Junction

D-1500T Receptacle housing (P.22)

D-1900D Board-mounting horizontal type (P.25)

D-1500T Panel housing vertical type (P.24)

D-1500T Receptacle housing (P.24)

D-1500T Panel housing vertical type (P.24)

D-1900D Receptacle housing (P.25)

D-1900D Double-Row Type

D-1000 Series Contact

■ Crimp Contacts

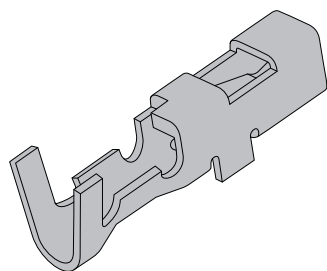

Receptacle Contact
(for Receptacle housing)

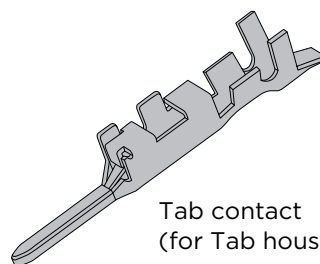

Tab contact
(for Tab housing)

| Wire Range | | Outside Diameter of Insulation mm | Wire Range Mark | Contacts | | | | | Applicable tools | |
|------------|-----------------|-----------------------------------|-----------------|--------------------|------------|-------------|-------------|-------------|---|---------------------------------|
| AWG | mm ² | | | Receptacle Contact | | | Tab Contact | | CCII hand tool PEW12 hand tool* (PEW12 dies Only) | Tool numbers Mini Applicator |
| | | | | Plating | Strip form | Loose Piece | Strip form | Loose Piece | | |
| 30 | 0.05 | 0.6-1.2 | S | Gold Plating | 1827569-2 | 1827586-2 | 1903111-2 | 1903115-2 | 2119144-1 1762952-1* (1762453-1) | 2114042-2 |
| 28 | 0.10 | | | Tin plating | — | — | — | — | | |
| 28 | 0.08 | 1.08-1.6 | M | Gold Plating | 1827570-2 | 1827587-2 | 1903112-2 | 1903116-2 | 2119141-1 1762846-1* (1762847-1) | 2151082-1 |
| 26 | 0.12 | | | Tin plating | 1871303-1 | 1871743-1 | 1903120-1 | 1903124-1 | | |
| 24 | 0.20 | | | | | | | | | |
| 22 | 0.37 | | | | | | | | | |
| 28 | 0.08 | 1.08-1.9 | L | Gold Plating | 1827571-2 | 1827588-2 | 1903113-2 | 1903117-2 | 2119143-1 1762950-1* (1762951-1) | 2114043-2 |
| 26 | 0.12 | | | Tin plating | 1871304-1 | 1871744-1 | 1903121-1 | 1903125-1 | | |
| 24 | 0.20 | | | | | | | | | |
| 22 | 0.37 | | | | | | | | | |
| 22 | 0.34-0.37 | 1.4-2.2 | 2L | Gold Plating | 1827572-2 | 1827589-2 | 1903114-2 | 1903118-2 | 2119142-1 1762625-1* (1762626-1) | 2151083-1 |
| 20 | 0.51-0.53 | | | Tin plating | 1871731-1 | 1871745-1 | 1903122-1 | 1903126-1 | | |
| 18 | 0.85-0.87 | | | | | | | | | |

Remarks: **The contacts L and 2L do not fit into the D-1100 receptacle housing and tab housing.**

When ordering, specify your requirements by multiplying the quantity.
 Contact our Sales Department for more information.
 Gold Plating: 0.38µm Tin plating: 2.0µm
 For mini-applicators information, contact our Sales Department.

Keying plug: 1939588-1

Strip Form contacts are used with Mini-applicators (bench machine) and Loose-Piece contacts are with hand tools.

Keying Plug with flip locator use CCII hand tools (CERT@CRIMP11)

PEW12 dies are interchangeable hand tools.

* Only hand tools are available with dies, part number 9-147824D-0

Receptacle contacts are only available for receptacle housings, while the Tab housings are only available for tab housings. Refer to pages P.107-112 for details of applicable tools.

Note: All Part Numbers are RoHS compliant.

D1100S Single-row Standard Types

Type Chart

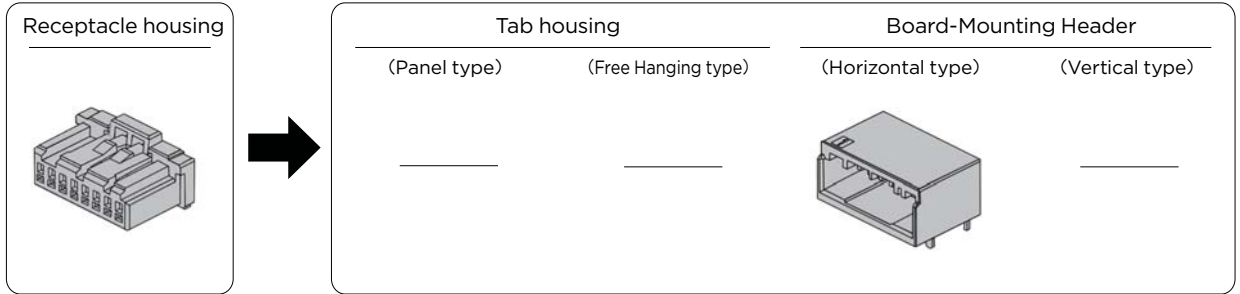

| Pos | Color | Key | Receptacle housing | Tab housing | | Plating | Board-Mounting Header | |
|-----|-------|-----|--------------------|-------------|-------------------|---------|-----------------------|---------------|
| | | | | Panel type | Free Hanging type | | Horizontal type | Vertical type |
| 4 | Black | X | 1-1939758-4 | — | — | Gold | 1-1939760-4 | — |
| | | Y | 2-1939758-4 | — | — | Tin | 1-1939761-4 | — |
| 8 | Black | X | 1-1939758-8 | — | — | Gold | 1-1939760-8 | — |
| | | Y | 2-1939758-8 | — | — | Gold | 2-1939760-8 | — |
| 10 | Black | X | 1-1939758-0 | — | — | Gold | 1-1939760-0 | — |
| | | Y | 2-1939758-0 | — | — | Tin | 1-1939761-0 | — |
| | | | | — | — | Gold | 2-1939760-0 | — |

Relative Product Information

Applicable contact ...P.13
Performance & Specifications ...P.11

Mated Dimensions

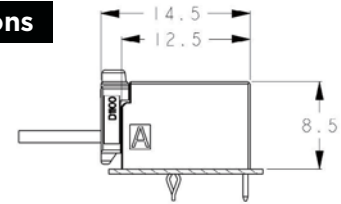

External Dimensions

■ Receptacle Housing

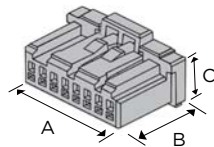

■ Board-Mounting Header

Horizontal type

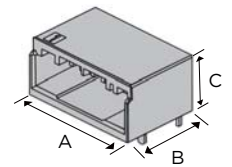

| Pos | Key | Color | Part Number | Dimensions | | |
|-----|-----|-------|-------------|------------|------|------|
| | | | | A | B | C |
| 4 | X | Black | 1-1939758-4 | 8.9 | 11.3 | 9.15 |
| | Y | | 2-1939758-4 | | | |
| 8 | X | Black | 1-1939758-8 | 16.9 | 11.3 | 9.15 |
| | Y | | 2-1939758-8 | | | |
| 10 | X | Black | 1-1939758-0 | 20.9 | 11.3 | 9.15 |
| | Y | | 2-1939758-0 | | | |

| Pos | Key | Plating | Color | Part Number | Dimensions | | |
|-----|-----|---------|-------|-------------|------------|------|-----|
| | | | | | A | B | C |
| 4 | X | Gold | Black | 1-1939760-4 | 10.6 | 12.5 | 8.5 |
| | | Tin | | 1-1939761-4 | | | |
| | Y | Gold | | 2-1939760-4 | | | |
| 8 | X | Gold | Black | 1-1939760-8 | 18.6 | 12.5 | 8.5 |
| | | Gold | | 2-1939760-8 | | | |
| 10 | X | Gold | Black | 1-1939760-0 | 22.6 | 12.5 | 8.5 |
| | | Tin | | 1-1939761-0 | | | |
| | Y | Gold | | 2-1939760-0 | | | |

D-1100D Double-row Standard Types

Type Chart

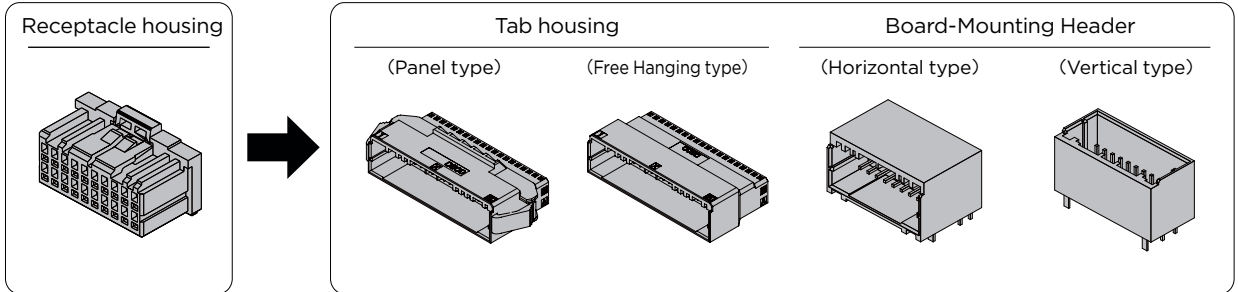

| Pos | Color | Key | Receptacle housing | Tab housing | | Plating | Board-Mounting Header | |
|-----|-------|-----|--------------------|---------------|-------------------|---------|-----------------------|---------------|
| | | | | Panel type | Free Hanging type | | Horizontal type | Vertical type |
| 10 | Black | X | 1-1827862-5 | 1-2069681-5 | 1-2069682-5 | Gold | 1-1827873-5 | 1-2040516-5 |
| | | | 1-2333149-5** | | | Tin | 1-2271887-5 | 1-2341421-5 |
| 18 | Black | X | 1-1827862-9 | — | — | Gold | — | 1-2040516-9 |
| 20 | Black | X | 1-1827862-0 | — | — | Gold | 1-1827873-0 | — |
| | | | 1-2333149-0** | | | Tin | 1-2271887-0 | 1-2341421-0 |
| 22* | Black | X | 1-1827863-1 | 1-1903128-1 | 1-1903127-1 | Gold | — | 1-1827872-1 |
| | | | — | | | Tin | — | 1-2329463-1 |
| 24 | Black | X | 1-1827863-2 | — | — | Tin | — | 1-1871315-2 |
| | | | — | — | — | — | — | |
| 26* | Black | X | 1-1827863-3 | 1-1903128-3 | 1-1903127-3 | Gold | 1-1939638-3 | 1-1827872-3 |
| | | | 1-2333134-3** | | | Tin | 1-2271888-3 | 1-2329463-3 |
| | | Y | 2-1827863-3 | — | — | Gold | — | See P17 SMT |
| 28 | Black | X | 1-1827863-4 | 1-1903128-4 | 1-1903127-4 | Gold | 1-1939638-4 | 1-1827872-4 |
| | | | 1-2333134-4** | | | Tin | 1-2271888-4 | 1-2329463-4 |
| 30* | Black | X | 1-1827863-5 | — | — | Gold | 1-1939638-5 | 1-1827872-5 |
| | | | — | | | Tin | 1-2271888-5 | 1-2329463-5 |
| 32* | Black | X | 1-1827863-6 | 1-1903128-6 | 1-1903127-6 | Gold | — | 1-1827872-6 |
| | | | — | | | Tin | — | 1-2329463-6 |
| 34* | Black | X | 1-1827863-7 | 1-1903128-7 | 1-1903127-7 | Gold | 1-1939638-7 | 1-1827872-7 |
| | | | 1-2333134-7** | | | Tin | 1-2271888-7 | 1-2329463-7 |
| | | Y | 2-1827863-7 | — | — | Gold | — | 2-1827872-7 |
| 40* | Black | X | 1-1827863-0 | 1-1903128-0 | 1-1903127-0 | Gold | 1-1939638-0 | 1-1827872-0 |
| | | | 1-2333134-0** | 1-2350416-0** | | Tin | 1-2271888-0 | 1-2329463-0 |

* There are products in other colors available. Please consult TE's sales representative.

** The product marked with "**" has a high-retention force version of Receptacle housing.

Related product information

Applicable contact ...P.13

Performance & Specifications ...P.11

Note: All Part Numbers are RoHS compliant.

D-1100D Double-row Standard Types

Mated Dimension

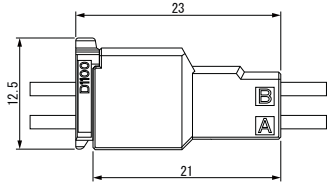

Panel/Free Hanging type

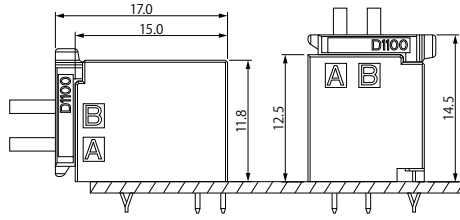

Horizontal/Vertical type

External Dimensions

■ Receptacle Housing

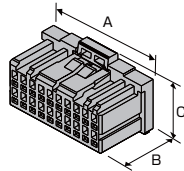

| Pos | Key | Color | Part Number | Dimensions | | |
|-----|-----|-------|-------------|------------|------|------|
| | | | | A | B | C |
| 10 | X | Black | 1-1827862-5 | 12.6 | 11.3 | 12.5 |
| | | | 1-2333149-5 | | | |
| 18 | X | Black | 1-1827862-9 | 20.6 | 11.3 | 12.5 |
| 20 | X | Black | 1-1827862-0 | 22.6 | 11.3 | 12.5 |
| | | | 1-2333149-0 | | | |
| 22 | X | Black | 1-1827863-1 | 24.6 | 11.3 | 12.5 |
| | | | — | | | |
| 24 | X | Black | 1-1827863-2 | 26.6 | 11.3 | 12.5 |
| 26 | X | Black | 1-1827863-3 | 28.6 | 11.3 | 12.5 |
| | | | 1-2333134-3 | | | |
| | Y | Black | 2-1827863-3 | | | |
| 28 | X | Black | 1-1827863-4 | 30.6 | 11.3 | 12.5 |
| | | | 1-2333134-4 | | | |
| 30 | X | Black | 1-1827863-5 | 32.6 | 11.3 | 12.5 |
| | | | — | | | |
| 32 | X | Black | 1-1827863-6 | 34.6 | 11.3 | 12.5 |
| 34 | X | Black | 1-1827863-7 | 36.6 | 11.3 | 12.5 |
| | | | 1-2333134-7 | | | |
| | Y | Black | 2-1827863-7 | | | |
| 40 | X | Black | 1-1827863-0 | 42.6 | 11.3 | 12.5 |
| | | | 1-2333134-0 | | | |

■ Tab Housing

Panel type

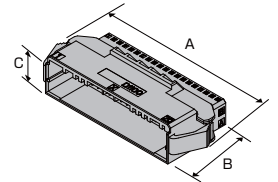

| Pos | Key | Color | Part Number | Dimensions | | |
|-----|-----|-------|-------------|------------|------|------|
| | | | | A | B | C |
| 10 | X | Black | 1-2069681-5 | 22.1 | 21.0 | 13.9 |
| 22 | X | Black | 1-1903128-1 | 34.1 | 21.0 | 13.9 |
| 26 | X | Black | 1-1903128-3 | 38.1 | 21.0 | 13.9 |
| 28 | X | Black | 1-1903128-4 | 40.1 | 21.0 | 13.9 |
| 32 | X | Black | 1-1903128-6 | 44.1 | 21.0 | 13.9 |
| 34 | X | Black | 1-1903128-7 | 46.1 | 21.0 | 13.9 |
| | | | 1-1903128-0 | | | |
| | | | 1-2350416-0 | | | |
| 40 | X | Black | 1-1903128-0 | 52.1 | 21.0 | 13.9 |

Free Hanging type

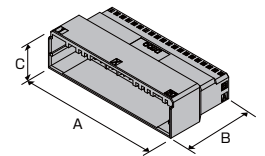

| Pos | Key | Color | Part Number | Dimensions | | |
|-----|-----|-------|-------------|------------|------|------|
| | | | | A | B | C |
| 10 | X | Black | 1-2069682-5 | 12.6 | 21.0 | 11.3 |
| 22 | X | Black | 1-1903127-1 | 24.6 | 21.0 | 11.3 |
| 26 | X | Black | 1-1903127-3 | 28.6 | 21.0 | 11.3 |
| 28 | X | Black | 1-1903127-4 | 30.6 | 21.0 | 11.3 |
| 32 | X | Black | 1-1903127-6 | 34.6 | 21.0 | 11.3 |
| 34 | X | Black | 1-1903127-7 | 36.6 | 21.0 | 11.3 |
| 40 | X | Black | 1-1903127-0 | 42.6 | 21.0 | 11.3 |

Note: All Part Numbers are RoHS compliant.

D-1100D Double-row Standard Types

Board-Mounting Header

Horizontal type

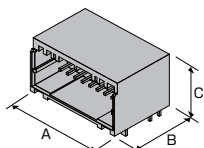

| Pos | Key | Plating | Color | Part Number | Dimensions | | |
|-----|-----|---------|-------|-------------|------------|------|------|
| | | | | | A | B | C |
| 10 | X | Gold | Black | 1-1827873-5 | 12.6 | 15.0 | 11.8 |
| | | Tin | | 1-2271887-5 | | | |
| 20 | X | Gold | Black | 1-1827873-0 | 22.6 | 15.0 | 11.8 |
| | | Tin | | 1-2271887-0 | | | |
| 26 | X | Gold | Black | 1-1939638-3 | 28.6 | 15.0 | 11.8 |
| | | Tin | | 1-2271888-3 | | | |
| 28 | X | Gold | Black | 1-1939638-4 | 30.6 | 15.0 | 11.8 |
| | | Tin | | 1-2271888-4 | | | |
| 30 | X | Gold | Black | 1-1939638-5 | 32.6 | 15.0 | 11.8 |
| | | Tin | | 1-2271888-5 | | | |
| 34 | X | Gold | Black | 1-1939638-7 | 36.6 | 15.0 | 11.8 |
| | | Tin | | 1-2271888-7 | | | |
| 40 | X | Gold | Black | 1-1939638-0 | 42.6 | 15.0 | 11.8 |
| | | Tin | | 1-2271888-0 | | | |

Vertical type

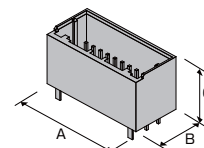

| Pos | Key | Plating | Color | Part Number | Dimensions | | |
|-----|-----|---------|-------|-------------|------------|------|------|
| | | | | | A | B | C |
| 10 | X | Gold | Black | 1-2040516-5 | 12.6 | 11.3 | 12.5 |
| | | Tin | | 1-2341421-5 | | | |
| 18 | X | Gold | Black | 1-2040516-9 | 20.6 | 11.3 | 12.5 |
| 20 | X | Tin | Black | 1-2341421-0 | 22.6 | 11.3 | 12.5 |
| 22 | X | Gold | Black | 1-1827872-1 | 24.6 | 11.3 | 12.5 |
| | | Tin | | 1-2329463-1 | | | |
| 24 | X | Tin | Black | 1-1871315-2 | 26.6 | 11.3 | 12.5 |
| 26 | X | Gold | Black | 1-1827872-3 | 28.6 | 11.3 | 12.5 |
| | | Tin | | 1-2329463-3 | | | |
| 28 | X | Gold | Black | 1-1827872-4 | 30.6 | 11.3 | 12.5 |
| | | Tin | | 1-2329463-4 | | | |
| 30 | X | Gold | Black | 1-1827872-5 | 32.6 | 11.3 | 12.5 |
| | | Tin | | 1-2329463-5 | | | |
| 32 | X | Gold | Black | 1-1827872-6 | 34.6 | 11.3 | 12.5 |
| | | Tin | | 1-2329463-6 | | | |
| 34 | X | Gold | Black | 1-1827872-7 | 36.6 | 11.3 | 12.5 |
| | | Tin | | 1-2329463-7 | | | |
| 40 | X | Gold | Black | 1-1827872-0 | 42.6 | 11.3 | 12.5 |
| | | Tin | | 1-2329463-0 | | | |

SMT

Board-Mounting Header

Vertical type

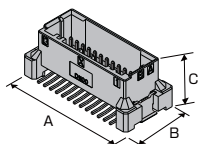

| Pos | Key | Plating | Color | Part Number | Dimensions | | |
|-----|-----|---------|-------|--------------|------------|------|------|
| | | | | | A | B | C |
| 26 | X | Gold | Black | 1-1939995-3 | 34.6 | 16.3 | 13.5 |
| | | | | 1-2339471-3* | | | |
| 40 | Y | Gold | Black | 2-1939995-3 | 48.6 | 16.3 | 13.5 |
| | | | | 1-1939995-0 | | | |
| 40 | Y | Gold | Black | 1-1939995-0 | 48.6 | 16.3 | 13.5 |
| | | | | 2-1939995-0 | | | |

* Packaging form: emboss.

Note: All Part Numbers are RoHS compliant.

D-1200S Single Row/High Voltage Types

Type Chart

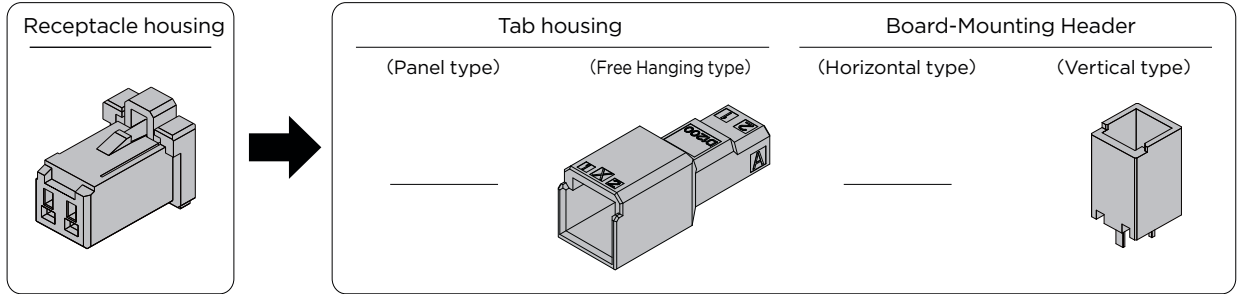

| Pos | Color | Key | Receptacle housing | Tab housing | | Plating | Board-Mounting Header | |
|-----|-------|-----|--------------------|-------------|-------------------|---------|-----------------------|---------------|
| | | | | Panel type | Free Hanging type | | Horizontal type | Vertical type |
| 2 | Black | X | 1-1871465-2 | — | 1-1903129-2 | Gold | — | 1-1871468-2 |
| | — | Y | — | — | — | Tin | — | 1-2348456-2 |

Relative Product Information

Applicable contact ...P.13
Performance & Specifications ...P.11

Mated Dimension

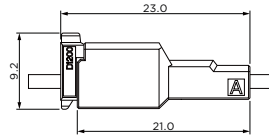

Free Hanging type

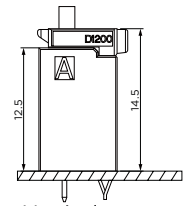

Vertical type

External Dimensions

Receptacle Housing

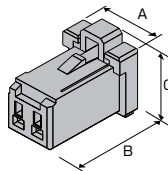

| Pos | Key | Color | Part Number | Dimensions | | |
|-----|-----|-------|-------------|------------|------|-----|
| | | | | A | B | C |
| 2 | X | Black | 1-1871465-2 | 7.6 | 11.3 | 9.2 |

Tab Housing

Free Hanging type

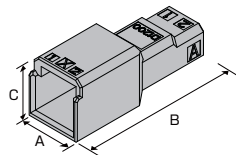

| Pos | Key | Color | Part Number | Dimensions | | |
|-----|-----|-------|-------------|------------|------|-----|
| | | | | A | B | C |
| 2 | X | Black | 1-1903129-2 | 7.6 | 21.0 | 8.0 |

Board-Mounting Header

Vertical type

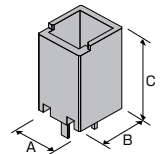

| Pos | Key | Plating | Color | Part Number | Dimensions | | |
|-----|-----|---------|-------|-------------|------------|-----|------|
| | | | | | A | B | C |
| 2 | X | Gold | Black | 1-1871468-2 | 7.6 | 8.0 | 12.5 |

Note: All Part Numbers are RoHS compliant.

D-1200D Double Row High Voltage Types

Type Chart

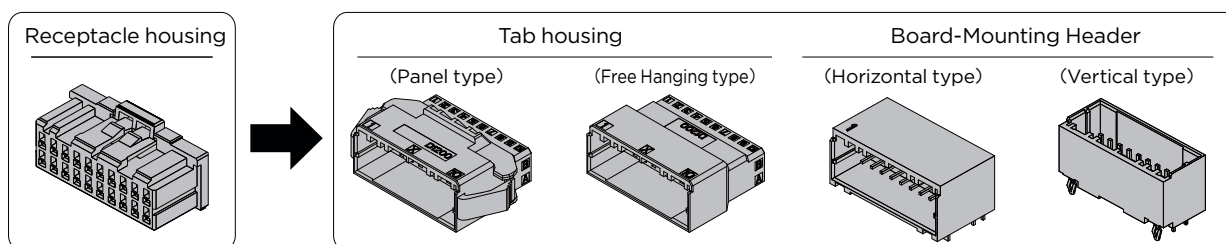

| Pos | Color | Key | Receptacle housing | Tab housing | | Plating | Board-Mounting Header | |
|-----|-------|-----|--|-------------|-------------------|---------|-----------------------|---------------|
| | | | | Panel type | Free Hanging type | | Horizontal type | Vertical type |
| 4 | Black | X | 1-1827864-2 9-1827864-2* | 1-1903131-2 | 1-1903130-2 | Gold | 1-1827876-2 | 1-1827875-2 |
| | Black | Y | 2-1827864-2 | — | — | Gold | 1-2348455-2 | 1-2348454-2 |
| 6 | Black | X | 1-1827864-3 9-1827864-3* | 1-1903131-3 | 1-1903130-3 | Gold | 1-1827876-3 | 1-1827875-3 |
| | Black | Y | 2-1827864-3 | 2-1903131-3 | 2-1903130-3 | Gold | 1-2348455-3 | 1-2348454-3 |
| 8 | Black | X | 1-1827864-4 1-2349949-4** | 1-1903131-4 | 1-1903130-4 | Gold | 1-1827876-4 | 1-1827875-4 |
| | Black | Y | 2-1827864-4 | 2-1903131-4 | 2-1903130-4 | Gold | 1-2348455-4 | 1-2348454-4 |
| 10 | Black | X | 1-1827864-5 | — | — | Gold | — | 1-1827875-5 |
| | Black | Y | 2-1827864-5 | — | — | Gold | — | 1-2348454-5 |
| 12 | Black | X | 1-1827864-6 9-1827864-6* 1-2349949-6** | 1-1903131-6 | 1-1903130-6 | Gold | 1-1827876-6 | 1-1827875-6 |
| | Black | Y | 2-1827864-6 | — | — | Gold | 1-2348455-6 | 1-2348454-6 |
| 16 | Black | X | 1-1827864-8 | — | — | Gold | — | 1-1827875-8 |
| | Black | Y | 2-1827864-8 | — | — | Gold | — | 1-2348454-8 |
| 20 | Black | X | 1-1827864-0 | 1-1903131-0 | 1-1903130-0 | Gold | 1-1827876-0 | 1-1827875-0 |
| | Black | Y | 2-1827864-0 | 2-1903131-0 | 2-1903130-0 | Gold | 1-2348455-0 | 1-2348454-0 |

* The Receptacle housing 9-1827864-□ is a latch-protected product with different locking heights. Please refer to P. 20

** The product marked with “**” is high-retention force version of Receptacle housing.

Relative Product Information

Applicable contact ...P.13

Performance & Specifications ...P.11

Note: All Part Numbers are RoHS compliant.

D-1200D Double-row High-voltage Types

Mated Dimension

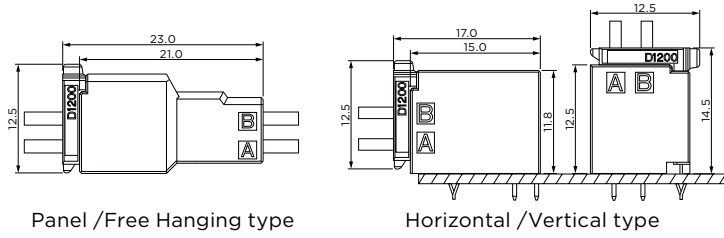

External Dimensions

■ Receptacle Housing

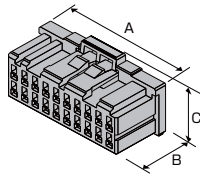

| Pos | Key | Color | Part Number | Dimensions | | |
|-----|-------|-------------|---------------|------------|------|-------|
| | | | | A | B | C |
| 4 | X | Black | 1-1827864-2 | 7.6 | 11.3 | 12.5 |
| | | Black | 9-1827864-2* | | | 12.65 |
| | Black | 2-1827864-2 | 12.5 | | | |
| 6 | X | Black | 1-1827864-3 | 10.1 | 11.3 | 12.5 |
| | | Black | 9-1827864-3* | | | 12.65 |
| | Black | 2-1827864-3 | 12.5 | | | |
| 8 | X | Black | 1-1827864-4 | 12.6 | 11.3 | 12.5 |
| | | Black | 1-2349949-4** | | | 12.5 |
| | Black | 2-1827864-4 | 12.5 | | | |
| 10 | X | Black | 1-1827864-5 | 15.1 | 11.3 | 12.5 |
| | Y | Black | 2-1827864-5 | | | 12.5 |
| 12 | X | Black | 1-1827864-6 | 17.6 | 11.3 | 12.5 |
| | | Black | 9-1827864-6* | | | 12.65 |
| | | Black | 1-2349949-6** | | | 12.5 |
| | Black | 2-1827864-6 | 12.5 | | | |
| 16 | X | Black | 1-1827864-8 | 22.6 | 11.3 | 12.5 |
| | Y | Black | 2-1827864-8 | | | 12.5 |
| 20 | X | Black | 1-1827864-0 | 27.6 | 11.3 | 12.5 |
| | Y | Black | 2-1827864-0 | | | 12.5 |

* The product with protective latches has different locking heights.
 ** The product marked with "*" has high-retention force version of Receptacle housing.

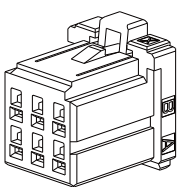

Standard products:
6P; key X:
1-1827864-3

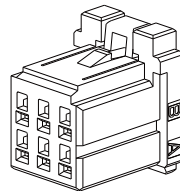

Products with protective
latches: 6P; key X:
9-1827864-3

■ Tab Housing

Panel type

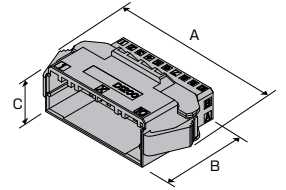

| Pos | Key | Color | Part Number | Dimensions | | |
|-----|-----|-------|-------------|------------|------|------|
| | | | | A | B | C |
| 4 | X | Black | 1-1903131-2 | 17.1 | 21.0 | 13.9 |
| 6 | X | Black | 1-1903131-3 | 19.6 | 21.0 | 13.9 |
| | | | 2-1903131-3 | | | |
| 8 | X | Black | 1-1903131-4 | 22.1 | 21.0 | 13.9 |
| | | | 2-1903131-4 | | | |
| 12 | X | Black | 1-1903131-6 | 27.1 | 21.0 | 13.9 |
| 20 | X | Black | 1-1903131-0 | 37.1 | 21.0 | 13.9 |
| | | | 2-1903131-0 | | | |

Free Hanging type

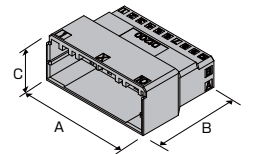

| Pos | Key | Color | Part Number | Dimensions | | |
|-----|-----|-------|-------------|------------|------|------|
| | | | | A | B | C |
| 4 | X | Black | 1-1903130-2 | 7.6 | 21.0 | 11.3 |
| 6 | X | Black | 1-1903130-3 | 10.1 | 21.0 | 11.3 |
| | | | 2-1903130-3 | | | |
| 8 | X | Black | 1-1903130-4 | 12.6 | 21.0 | 11.3 |
| | | | 2-1903130-4 | | | |
| 12 | X | Black | 1-1903130-6 | 17.6 | 21.0 | 11.3 |
| 20 | X | Black | 1-1903130-0 | 27.6 | 21.0 | 11.3 |
| | | | 2-1903130-0 | | | |

Note: All Part Numbers are RoHS compliant.

D-1200D Double-row High-voltage Types

Board-Mounting Header

Horizontal type

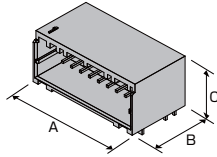

| Pos | Key | Plating | Color | Part Number | Dimensions | | |
|-----|-----|---------|-------|-------------|------------|------|------|
| | | | | | A | B | C |
| 4 | X | Gold | Black | 1-1827876-2 | 7.6 | 15.0 | 11.8 |
| | | Tin | Black | 1-2348455-2 | | | |
| | Y | Gold | Black | 2-1827876-2 | | | |
| 6 | X | Gold | Black | 1-1827876-3 | 10.1 | 15.0 | 11.8 |
| | | Tin | Black | 1-2348455-3 | | | |
| | Y | Gold | Black | 2-1827876-3 | | | |
| 8 | X | Gold | Black | 1-1827876-4 | 12.6 | 15.0 | 11.8 |
| | | Tin | Black | 1-2348455-4 | | | |
| | Y | Gold | Black | 2-1827876-4 | | | |
| 12 | X | Gold | Black | 1-1827876-6 | 17.6 | 15.0 | 11.8 |
| | | Tin | Black | 1-2348455-6 | | | |
| 20 | X | Gold | Black | 1-1827876-0 | 27.6 | 15.0 | 11.8 |
| | | Tin | Black | 1-2348455-0 | | | |
| | Y | Gold | Black | 2-1827876-0 | | | |

Vertical type

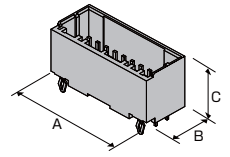

| Pos | Key | Plating | Color | Part Number | Dimensions | | |
|-----|-----|---------|-------|-------------|------------|------|------|
| | | | | | A | B | C |
| 4 | X | Gold | Black | 1-1827875-2 | 7.6 | 11.3 | 12.5 |
| | | Tin | Black | 1-2348454-2 | | | |
| | Y | Gold | Black | 2-1827875-2 | | | |
| 6 | X | Gold | Black | 1-1827875-3 | 10.1 | 11.3 | 12.5 |
| | | Tin | Black | 1-2348454-3 | | | |
| | Y | Gold | Black | 2-1827875-3 | | | |
| 8 | X | Gold | Black | 1-1827875-4 | 12.6 | 11.3 | 12.5 |
| | | Tin | Black | 1-2348454-4 | | | |
| | Y | Gold | Black | 2-1827875-4 | | | |
| 10 | X | Gold | Black | 1-1827875-5 | 15.1 | 11.3 | 12.5 |
| | | Tin | Black | 1-2348454-5 | | | |
| | Y | Gold | Black | 2-1827875-5 | | | |
| 12 | X | Gold | Black | 1-1827875-6 | 17.6 | 11.3 | 12.5 |
| | | Tin | Black | 1-2348454-6 | | | |
| | Y | Gold | Black | 2-1827875-6 | | | |
| 16 | X | Gold | Black | 1-1827875-8 | 22.6 | 11.3 | 12.5 |
| | | Tin | Black | 1-2348454-8 | | | |
| | Y | Gold | Black | 2-1827875-8 | | | |
| 20 | X | Gold | Black | 1-1827875-0 | 27.6 | 11.3 | 12.5 |
| | | Tin | Black | 1-2348454-0 | | | |
| | Y | Gold | Black | 2-1827875-0 | | | |

Fan Motor Water-Proof 3P

Wire-To-Wire

Panel mount type

| Pos | Part Number | |
|-----|-------------|-----------|
| 3 | Male | 2013891-1 |
| | Female | 2013892-1 |

Note: All Part Numbers are RoHS compliant.

D-1500T Triple-row High-voltage Modular Type

Type Chart

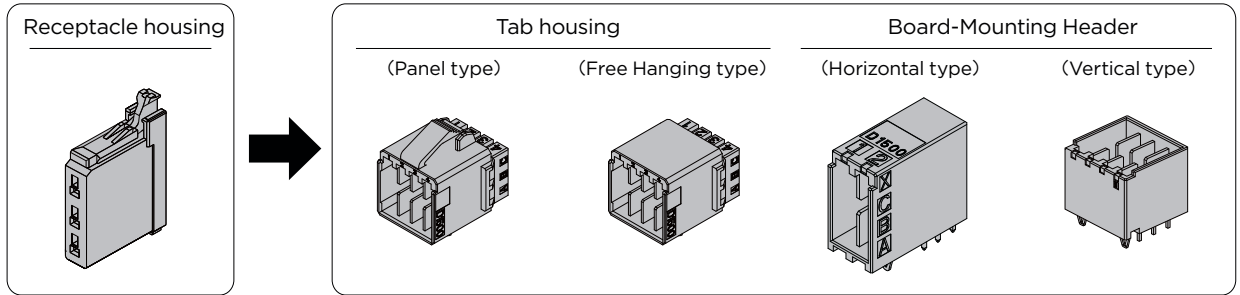

| Pos | Color | Key | Receptacle housing | Tab housing | | Plating | Board-Mounting Header | |
|-----|-------|-----|--------------------|-------------|-------------------|---------|-----------------------|---------------|
| | | | | Panel type | Free Hanging type | | Horizontal type | Vertical type |
| 3 | Black | X | 1-1827579-1 | — | 1-2040444-1 | — | — | 1-1827581-1 |
| 6 | Black | X | 1-2069029-2 | 1-2040404-2 | 1-2040444-2 | Gold | 1-1827583-2 | 1-1827581-2 |
| 9 | Black | X | 1-2069029-3 | — | 1-2040444-3 | Gold | — | 1-1827581-3 |
| 12 | Black | X | 1-2069029-4 | — | 1-2040444-4 | Gold | — | 1-1827581-4 |
| 36 | Black | X | — | 3-2040404-2 | — | Gold | — | — |

Relative Product Information

Applicable contact ...P.13

Performance & Specifications ...P.11

Mated Dimension

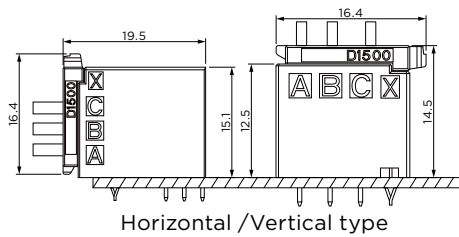

Horizontal /Vertical type

Receptacle Housing

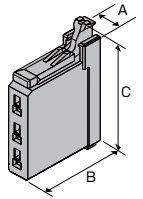

| Pos | Key | Color | Part Number | Dimensions | | |
|-----|-----|-------|-------------|------------|------|------|
| | | | | A | B | C |
| 3 | X | Black | 1-1827579-1 | 3.3 | 11.3 | 16.4 |
| 6 | X | Black | 1-2069029-2 | 6.8 | 11.3 | 16.4 |
| 9 | X | Black | 1-2069029-3 | 10.3 | 11.3 | 16.4 |
| 12 | X | Black | 1-2069029-4 | 13.8 | 11.3 | 16.4 |

Note: All Part Numbers are RoHS compliant.

D-1500T Triple-row High-voltage Modular Type

External Dimensions

■ Tab Housing

Panel type

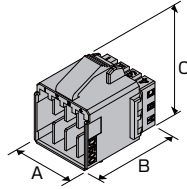

| Pos | Key | Color | Part Number | Dimensions | | |
|-----|-----|-------|-------------|------------|------|------|
| | | | | A | B | C |
| 6 | X | Black | 1-2040404-2 | 8.5 | 21.0 | 24.5 |
| 36 | X | Black | 3-2040404-2 | 43.5 | 21.0 | 24.5 |

Free Hanging type

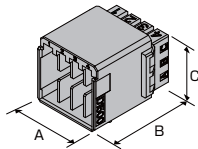

| Pos | Key | Color | Part Number | Dimensions | | |
|-----|-----|-------|-------------|------------|------|------|
| | | | | A | B | C |
| 3 | X | Black | 1-2040444-1 | 3.0 | 21.0 | 15.0 |
| 6 | X | Black | 1-2040444-2 | 6.5 | 21.0 | 15.0 |
| 9 | X | Black | 1-2040444-3 | 10.0 | 21.0 | 15.0 |
| 12 | X | Black | 1-2040444-4 | 13.5 | 21.0 | 15.0 |

Note: All Part Numbers are RoHS compliant.

■ Board-Mounting Header

Horizontal type

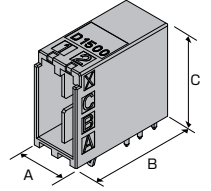

| Pos | Key | Plating | Color | Part Number | Dimensions | | |
|-----|-----|---------|-------|-------------|------------|------|------|
| | | | | | A | B | C |
| 6 | X | Gold | Black | 1-1827583-2 | 8.1 | 17.5 | 15.1 |

Vertical type

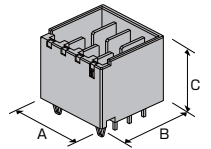

| Pos | Key | Plating | Color | Part Number | Dimensions | | |
|-----|-----|---------|-------|-------------|------------|------|------|
| | | | | | A | B | C |
| 3 | X | Gold | Black | 1-1827581-1 | 4.6 | 14.6 | 12.5 |
| 6 | X | Gold | Black | 1-1827581-2 | 8.1 | 14.6 | 12.5 |
| 9 | X | Gold | Black | 1-1827581-3 | 11.6 | 14.6 | 12.5 |
| 12 | X | Gold | Black | 1-1827581-4 | 15.1 | 14.6 | 12.5 |

D-1500T Junction Box

Type Chart

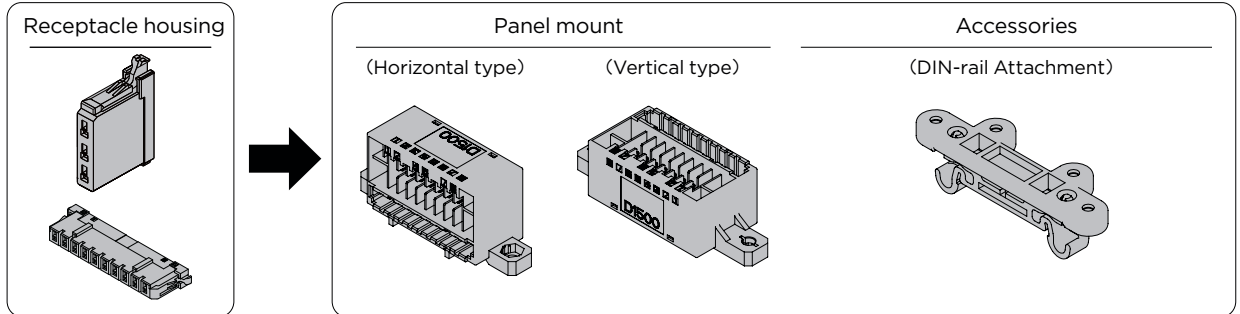

| Pos | Color | Key | Receptacle housing | Plating | Panel mount | | Accessories |
|-----|-------|-----|--------------------|---------|-----------------|---------------|----------------------|
| | | | | | Horizontal type | Vertical type | DIN-rail attachmentt |
| 3 | Black | X | 1-1827579-1 | — | — | — | — |
| 10 | Black | — | 1971150-1 | — | — | — | — |
| 34 | Black | — | — | Gold | 1971151-1 | 1971151-2 | 1971182-1* |

* 4 screws are needed for fixation

Relative Product Information

Applicable contact ...P.13

Performance & Specifications...P.11

External Dimensions

Receptacle Housing

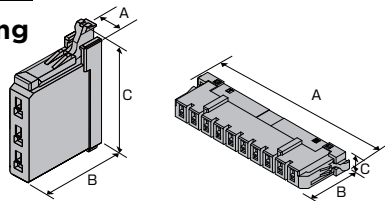

| Pos | Key | Color | Part Number | Dimensions | | |
|-----|-----|-------|-------------|------------|------|------|
| | | | | A | B | C |
| 3 | X | Black | 1-1827579-1 | 3.3 | 11.3 | 16.4 |
| 10 | — | Black | 1971150-1 | 42.2 | 11.3 | 4.6 |

Panel Mount

Horizontal type

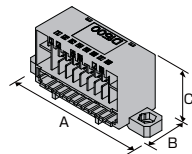

| Pos | Key | Plating | Color | Part Number | Dimensions | | |
|-----|-----|---------|-------|-------------|------------|------|------|
| | | | | | A | B | C |
| 34 | — | Gold | Black | 1971151-1 | 57.7 | 18.7 | 24.6 |

Note: All Part Numbers are RoHS compliant.

Vertical type

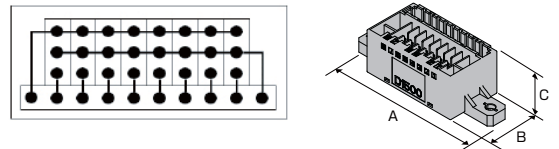

| Pos | Key | Plating | Color | Part Number | Dimensions | | |
|-----|-----|---------|-------|-------------|------------|------|------|
| | | | | | A | B | C |
| 34 | — | Gold | Black | 1971151-2 | 64.8 | 22.8 | 18.2 |

Accessories

Pins to be mounted with a foot attachment

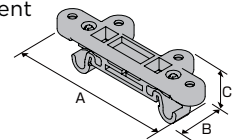

| Pos | Key | Color | Part Number | Dimensions | | |
|-----|-----|-------|-------------|------------|------|------|
| | | | | A | B | C |
| — | — | Black | 1971182-1 | 67.5 | 19.0 | 18.1 |

D-1900D Double-row Spring Clamp Type

Type Chart

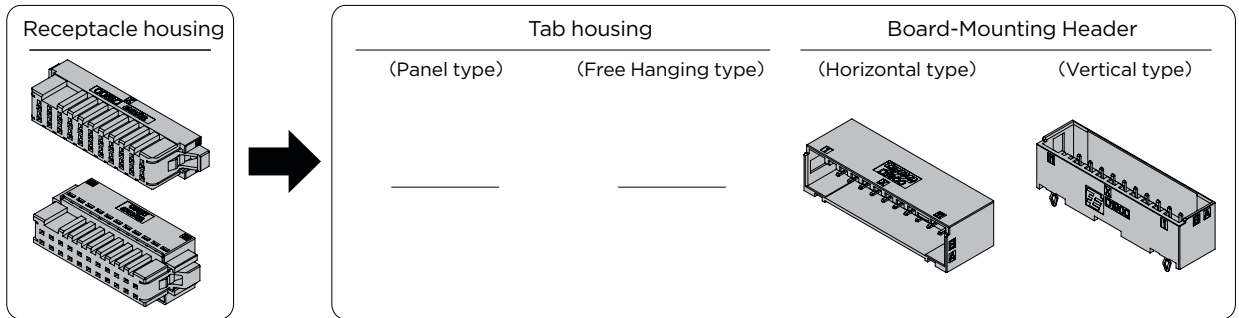

| Pos | Color | Key | Receptacle housing | Receptacle Assembly | Tab housing | | Board-Mounting Header | |
|-----|-------|-----|--------------------|---------------------|-------------|-------------------|-----------------------|---------------|
| | | | Spring Crimp | Spring Clamp type | Panel type | Free Hanging type | Horizontal type | Vertical type |
| 8 | Black | X | 1-1871946-4 | 1-1871940-4 | — | — | 1-1871935-4 | 1-2013325-4 |
| 12 | Black | X | 1-1871946-6 | 1-1871940-6 | — | — | 1-1871935-6 | 1-2013325-6 |
| 16 | Black | X | 1-1871946-8 | 1-1871940-8 | — | — | 1-1871935-8 | — |
| 22 | Black | X | 2-1871946-1 | 2-1871940-1 | — | — | 2-1871935-1 | 2-2013325-1 |
| 30 | Black | X | — | 2-1871940-5 | — | — | — | — |
| 38 | Black | X | — | 2-1871940-9 | — | — | 2-1871935-9 | — |

Relative Product Information

Applicable contact ...P.13
 Performance & Specifications ...P.11
 Special tool 1891348-1

Mated Dimension

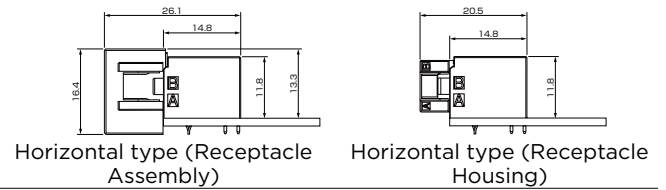

External Dimensions

■ Receptacle Housing (Crimp type)

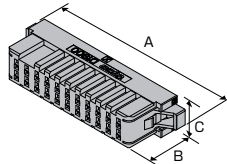

| Pos | Key | Color | Part Number | Dimensions | | |
|-----|-----|-------|-------------|------------|------|-----|
| | | | | A | B | C |
| 8 | X | Black | 1-1871946-4 | 24.2 | 15.0 | 9.9 |
| 12 | X | Black | 1-1871946-6 | 34.2 | 15.0 | 9.9 |
| 16 | X | Black | 1-1871946-8 | 41.2 | 15.0 | 9.9 |
| 22 | X | Black | 2-1871946-1 | 51.7 | 15.0 | 9.9 |

■ Receptacle Assembly (Spring clamp)

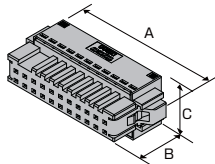

| Pos | Key | Plating | Color | Part Number | Dimensions | | |
|-----|-----|---------|-------|-------------|------------|------|------|
| | | | | | A | B | C |
| 8 | X | Gold | Black | 1-1871940-4 | 25.2 | 20.6 | 16.4 |
| 12 | X | Gold | Black | 1-1871940-6 | 32.2 | 20.6 | 16.4 |
| 16 | X | Gold | Black | 1-1871940-8 | 39.2 | 20.6 | 16.4 |
| 22 | X | Gold | Black | 2-1871940-1 | 49.7 | 20.6 | 16.4 |
| 30 | X | Gold | Black | 2-1871940-5 | 63.7 | 20.6 | 16.4 |
| 38 | X | Gold | Black | 2-1871940-9 | 77.7 | 20.6 | 16.4 |

Note: All Part Numbers are RoHS compliant.

■ Board-Mounting Header

Horizontal type

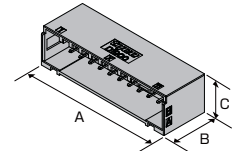

| Pos | Key | Plating | Color | Part Number | Dimensions | | |
|-----|-----|---------|-------|-------------|------------|------|------|
| | | | | | A | B | C |
| 8 | X | Gold | Black | 1-1871935-4 | 19.8 | 14.8 | 11.8 |
| 12 | X | Gold | Black | 1-1871935-6 | 26.8 | 14.8 | 11.8 |
| 16 | X | Gold | Black | 1-1871935-8 | 33.8 | 14.8 | 11.8 |
| 22 | X | Gold | Black | 2-1871935-1 | 44.3 | 14.8 | 11.8 |
| 30 | X | Gold | Black | 2-1871955-5 | 58.3 | 14.8 | 11.8 |
| 38 | X | Gold | Black | 2-1871935-9 | 72.3 | 14.8 | 11.8 |

Vertical type

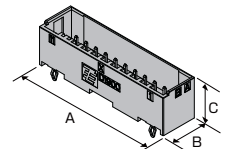

| Pos | Key | Plating | Color | Part Number | Dimensions | | |
|-----|-----|---------|-------|-------------|------------|------|------|
| | | | | | A | B | C |
| 8 | X | Gold | Black | 1-2013325-4 | 20.2 | 11.5 | 12.5 |
| 12 | X | Gold | Black | 1-2013325-6 | 26.8 | 11.5 | 12.5 |
| 22 | X | Gold | Black | 2-2013325-1 | 44.3 | 11.5 | 12.5 |

D-2000 Series

Series introduction

The D-2000 series is a compact connector in the Dynamic series and has the specifications for industrial machinery. Its proprietary concept-long contact wiping length-provides the high-reliability which is needed for industrial machinery. The series also includes the multi-position drawer type not found in any other series and the hybrid type that integrates signal and power contacts in a single connector.

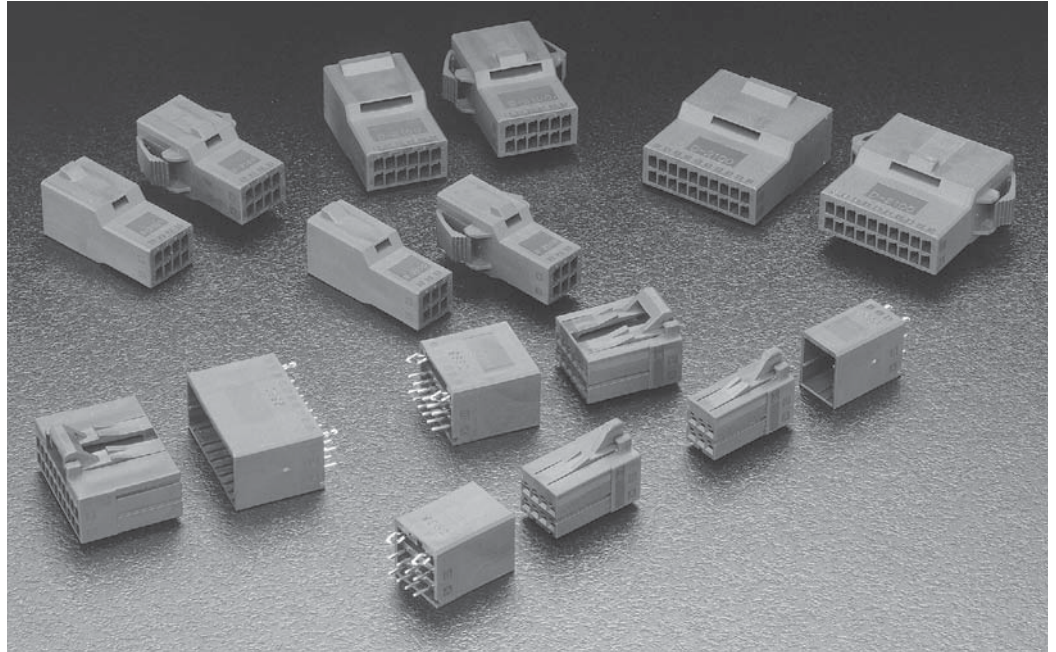

Product Features

1. Terminal and Housing Construction are Twist Resistant

The box shape receptacle contact is highly resistant to twisting and the housing slit also prevents angled mating to increase reliability.

2. Contact Wiping Length

Attaining the reliability needed for industrial machinery in a compact size by using a long contact wiping length.

3. Wire Sizes:

With its 2.5 mm pitch, it is a compact series, yet it can use 18 AWG wires, which are often used in industrial equipment.

4. Audible Latching

Obvious lock sound and feeling when mating means work can be done without mistakes, such as mismatching (halfmating), even if the connection cannot be seen.

5. Keying

The housing is keyed (with a slit), so differentiating between X keys and Y keys prevents mismatching. It is also possible to make more key patterns by using keying plugs.

6. Center Locking

This is the first application of a center lock in Dynamic series. On-board space requirements can be minimized because these connectors can be mounted in a tight space for high-density mounting on boards requiring signal lines.

7. Drawer Type

The drawer type connector was developed with a floating construction on one side for applications where it is not possible to see the connection. There can be up to 50 positions, the highest in the series. These connectors make it possible to make connections between units with flexibility.

8. Hybrid Type

The D-2600 series combines signal and power contacts in a single connector by using D-2000 contacts as signal contacts and D-3000 contacts as power ones. This saves on-board space and improves maintenance.

D-2000 Series Performance and Specifications

Performance

| Item | 2100S/D | 2100M | 2600D |
|---------------------------------|--|----------|----------|
| Pitch | 2.5mm | | |
| Rated Current: | 5A max | 2.6A max | 3.2A max |
| Rated Voltage | 250V AC/DC | | |
| Dielectric Withstanding Voltage | 1500V AC | 2300V AC | 1500V AC |
| Total resistance | 5mff max (initial) 10mff max (initial) | | |
| Insertion strength | 4.9N max (per pole) | | |
| Withdrawal strength | 0.29N max (per pole) | | |
| Durability | 500 cycles | | |
| Lock strength | 39.2N min | — | 98N min |

Product Specification

| Series Name | D-2100S/D | D-2100M | D-2600D |
|--|---------------------|----------|-----------|
| Product Specifications | 108-5619 | 108-5659 | 108-78301 |
| Applications Specifications | 114-5258 | | |
| Instruction sheet (hand tool) | 408-10414 (S) | | |
| | 408-8547-1(M) | | |
| Instruction sheet (extraction tool PN) | (1276716-1)411-5900 | | |

Please refer to the standards on P. 39 for the D-3000 contact used in D-2600D

Please refer to the manual when using the product. An e-Catalogue is also available for download from the Internet.

Positions / wire size / Rated Current

D-2100S/D value

| Position | Wire Size | | | | | |
|----------|-----------|--------|--------|--------|--------|--------|
| | AWG 18 | AWG 20 | AWG 22 | AWG 24 | AWG 26 | AWG 28 |
| 3 | 5 | 4.5 | 4.3 | 3.3 | 2.9 | 2.3 |
| 6 | 5 | 4.2 | 4 | 2.7 | 2.5 | 2 |
| 8 | 4.5 | 4 | 3.5 | 2.5 | 2.2 | 1.8 |
| 12 | 4 | 3.5 | 3 | 2.3 | 1.9 | 1.5 |
| 16 | 3.2 | 2.8 | 2.4 | 2 | 1.6 | 1.2 |
| 20 | 3.2 | 2.8 | 2.4 | 2 | 1.6 | 1.2 |

Materials and Plating

| Category | Material | Plating |
|-----------------------------------|--|---|
| Receptacle Contact Tab Contact | Copper alloys | 0.38 µm Gold plating over nickel underplate |
| Board mount Header | Copper alloys | 0.38 µm Gold plating over nickel underplate Tin plating on tail side |
| Housing | UL94-V-0, thermoplastic PBT with glass fiber | |

Safety Standards

The safety specifications listed below are approved on specific part numbers. Please contact our Technical Support Centre to check whether the part numbers you use are approved or not. Keep in mind that there are instances where values differ from those given by Tyco Electronics Specifications.

| Standards | series | D-2100 series | | | D-2100M Drawer Type | | |
|--|--------|---|---|-------------------|---|---|-------------------|
| | | Rated Voltage | Rated Current | Temperature Range | Rated Voltage | Rated Current | Temperature Range |
| Product Specifications 108-5619 (General) 108-5659 (drawer type) | | 250V AC/DC | 5A (unipolar) | -55°C -+105°C | 250V AC/DC | 2.6A [AWG#20 hours 50 pole load] | -5°C -+105°C |
| UL File No.E28476 | | Determined according to the requirements of application | Determined according to the requirements of application | — | Determined according to the requirements of application | Determined according to the requirements of application | — |
| CSA Report No. LR 7189 | | 250V AC/DC | AWG#24-#28: 3.3A AWG#18-#22: 5A | — | 250V AC/DC | Max 5A per pole | — |
| TÜV License No. R 9950679 | | 125V AC/DC | 5A | -55°C -+105°C | 125V AC/DC | Max 5A per pole | -5°C -+105°C |

D-2000 Series Configurations

D-2100S Single Row Type

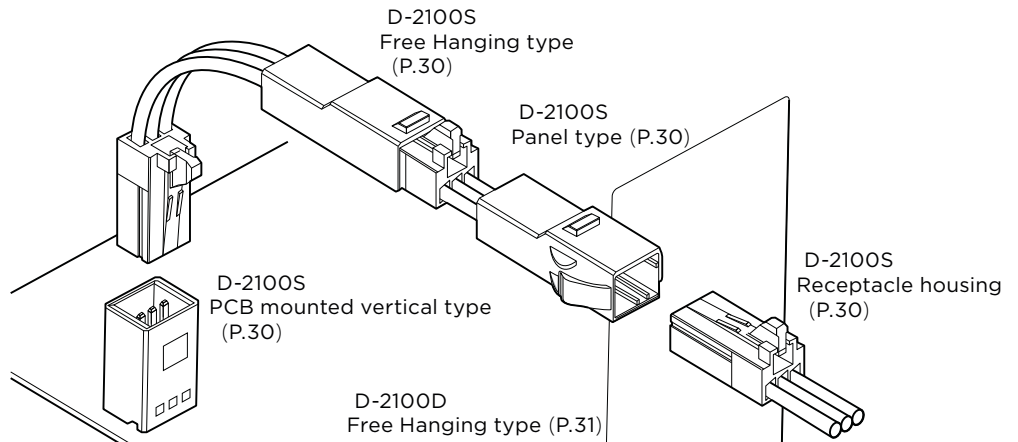

D-2100D Double Row Type

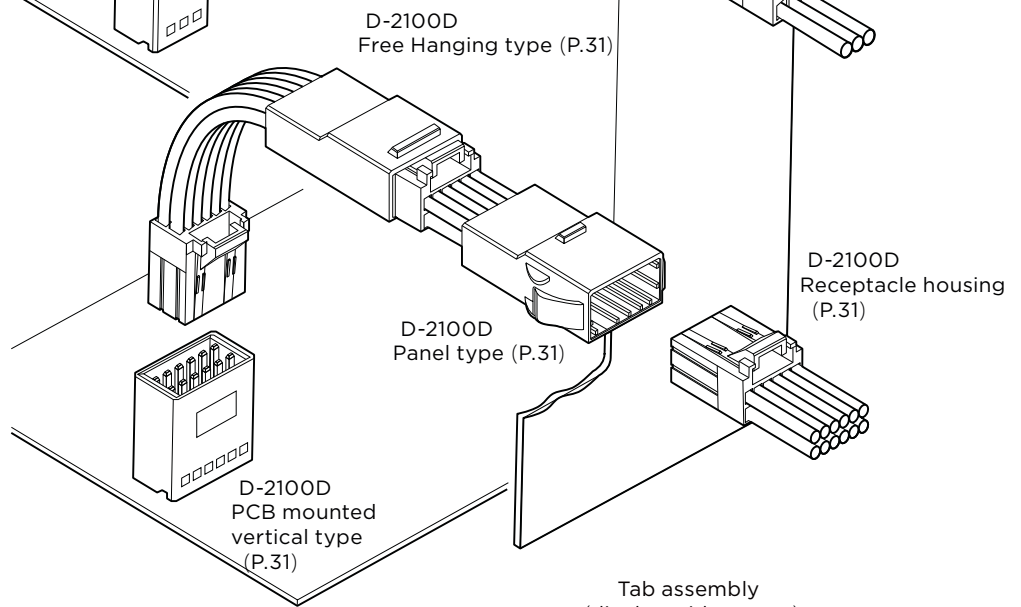

D-2100M Drawer Type

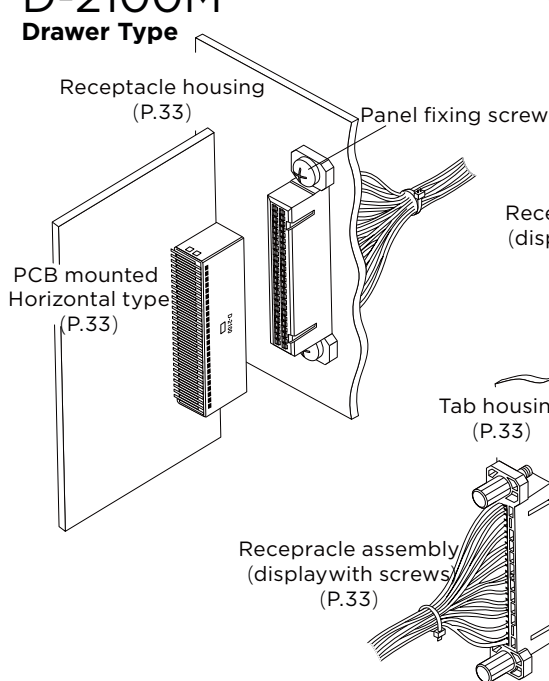

D-2600D Double-row Hybrid Type

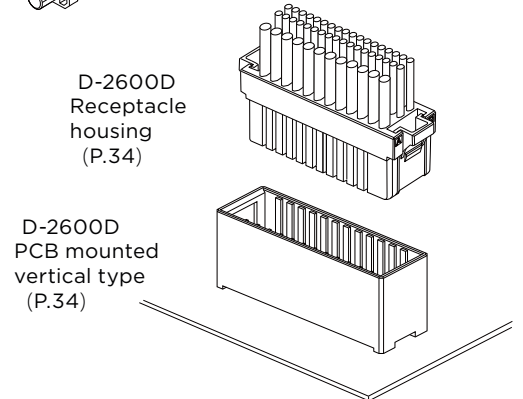

D-2000 Series Contact

■ **Crimped type**
(gold plating thickness
0.38 μm)

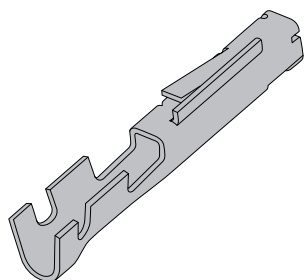

Receptacle Contact
(used in receptacle housing)

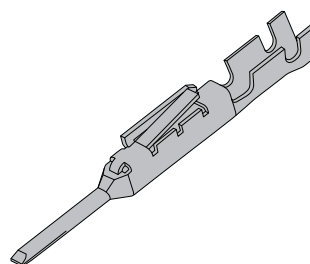

Tab contact
(used in tab housing)

| Wire Range | | Outside Diameter of Insulation mm | Wire Range Mark | Contact part number | | | | Models of applicable tools | |
|------------|-----------------|-----------------------------------|-----------------|---------------------|-------------|--------------|-------------|----------------------------|--------------|
| | | | | Receptacle Contact | | Tab Contact | | Hand Tools | Tool numbers |
| AWG | mm ² | | | Strip form | Loose Piece | Strip form | Loose Piece | | |
| 28 | 0.09 | 0.88-1.3 | S | 1318106-1 | 1318108-1 | 1318110-1 | 1318112-1 | 91576-1 | 2151240-1 |
| 26 | 0.12 | | | | | | | | |
| 24 | 0.20 | 1.11-1.43 | | | | | | | |
| 24 | 0.20 | 2.2-2.25 | S1 | 1-1318106-1* | --- | 1-1318110-1* | --- | --- | --- |
| 22 | 0.30 | 1.26-1.8 | M | 1318105-1 | 1318107-1 | 1318109-1 | 1318111-1 | 91595-1 | 2151071-1 |
| 20 | 0.50 | | | | | | | | |
| 18 | 0.85 | 1.79-1.9 | | | | | | | |

*This terminal is only applicable to the UL1051 cable.
Note: When placing your order, please check with the confirmed sales leadtime.

Please contact our sales department or distributor for more information.

Strip Form contacts are used with Mini-applicators (bench machine) and Loose-Piece contacts are with hand tools.

The receptacle contact can be used in all receptacle housings, the Tab housing can be used in all tab housings. Details of the applicable tools are available from P.107-111

NOTE: All products are RoHS compliant On selection.

D-2100S Single-row Standard Type

Type Chat

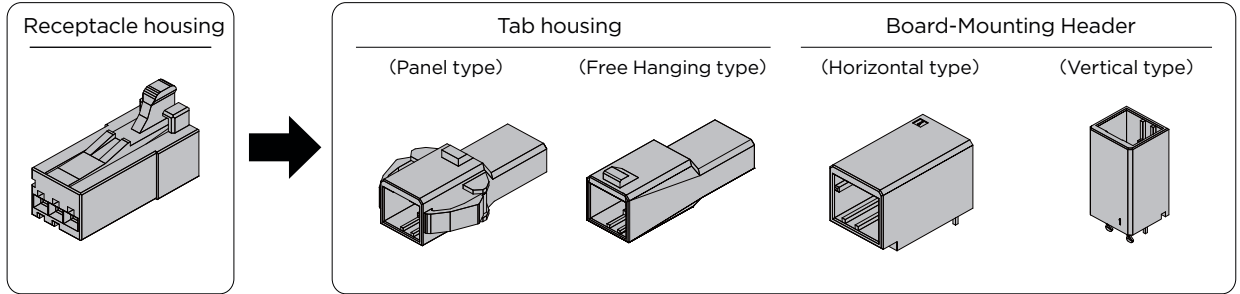

| Pos | Color | Key | Receptacle housing | Tab housing | | Plating | Board-Mounting Header | |
|-----|-------|-----|--------------------|-------------|-------------------|---------|-----------------------|---------------|
| | | | | Panel type | Free Hanging type | | Horizontal type | Vertical type |
| 3 | Black | X | 1-1318120-3 | 1-1318116-3 | 1-1318117-3 | Gold | 1376135-1 | 1318123-1 |
| | Black | Y | 2-1318120-3 | 2-1318116-3 | 2-1318117-3 | Gold | 1376135-2 | 1318123-2 |
| | Black | Z | 3-1318120-3 | — | — | Gold | 1376135-3 | — |
| | Black | X | 1-1473074-3* | — | — | Gold | — | 1-1318123-1 |

The * mark means drawer typer

Relative Product Information

Application contact...P.29
Performance & Specifications...P.27

Mated Dimension

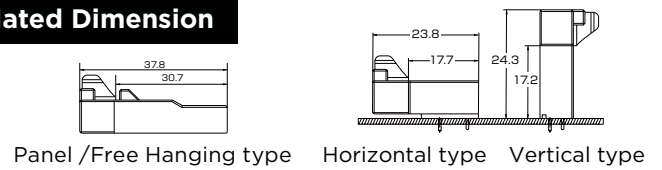

External Dimensions

Receptacle Housing

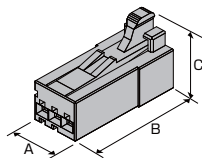

| Pos | Key | Color | Part Number | Dimensions | | |
|-----|-----|-------|-------------|------------|------|------|
| | | | | A | B | C |
| 3 | X | Black | 1-1318120-3 | 8.9 | 20.0 | 12.0 |
| | Y | Black | 2-1318120-3 | | | |
| | Z | Black | 3-1318120-3 | 8.9 | 20.0 | 11.8 |
| | X | Black | 1-1473074-3 | | | |

Tab Housing

Panel type

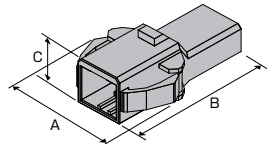

| Pos | Key | Color | Part Number | Dimensions | | |
|-----|-----|-------|-------------|------------|------|-----|
| | | | | A | B | C |
| 3 | X | Black | 1-1318116-3 | 19.7 | 30.7 | 9.5 |
| | Y | Black | 2-1318116-3 | | | |

Free Hanging type

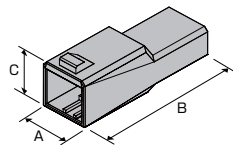

| Pos | Key | Plating | Color | Part Number | Dimensions | | |
|-----|-----|---------|-------|-------------|------------|------|-----|
| | | | | | A | B | C |
| 3 | X | — | Black | 1-1318117-3 | 10.2 | 30.7 | 9.5 |
| | Y | — | Black | 2-1318117-3 | | | |

Board-Mounting Header

Horizontal type

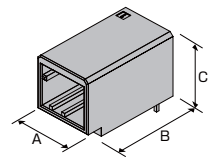

| Pos | Key | Plating | Color | Part Number | Dimensions | | |
|-----|-----|---------|-------|-------------|------------|------|------|
| | | | | | A | B | C |
| 3 | X | Gold | Black | 1376135-1 | 10.2 | 17.7 | 11.0 |
| | Y | Gold | Black | 1376135-2 | | | |
| | Z | Gold | Black | 1376135-3 | | | |

Vertical type

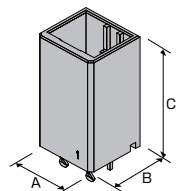

| Pos | Key | Plating | Color | Part Number | Dimensions | | |
|-----|-----|---------|-------|-------------|------------|-----|------|
| | | | | | A | B | C |
| 3 | X | Gold | Black | 1318123-1 | 10.2 | 9.5 | 17.8 |
| | | Gold | Black | 1-1318123-1 | | | |
| | | Gold | Black | 1318123-2 | | | |

NOTE: All products are RoHS compliant On selection.

D-2100D Double-row Standard Type

Type Chart

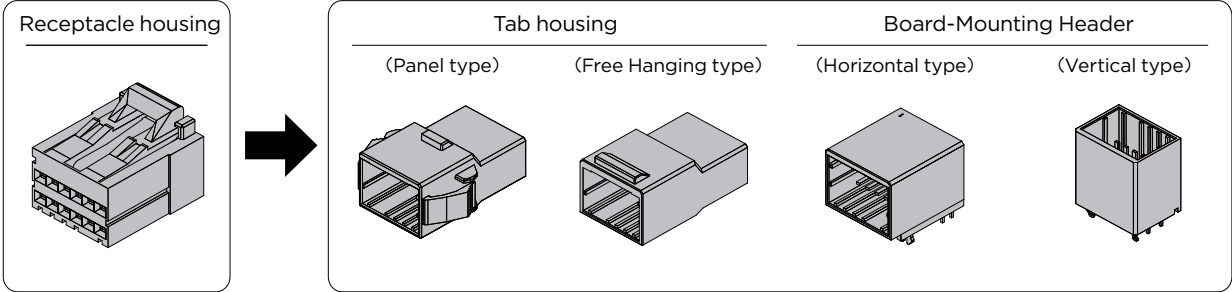

| Pos | Color | Key | Receptacle housing | Tab housing | | Plating | Board-Mounting Header | |
|-----|-------|-----|--------------------|-------------|-------------------|---------|-----------------------|---------------|
| | | | | Panel type | Free Hanging type | | Horizontal type | Vertical type |
| 6 | Black | X | 1-1318119-3 | 1-1318114-3 | 1-1318115-3 | Gold | 1376136-1 | 1318124-1 |
| | Black | Y | 2-1318119-3 | 2-1318114-3 | 2-1318115-3 | Gold | 1376136-2 | 1318124-2 |
| 8 | Black | X | 1-1318119-4 | 1-1318114-4 | 1-1318115-4 | Gold | 1376009-1 | 1318125-1 |
| | Black | Y | 2-1318119-4 | 2-1318114-4 | 2-1318115-4 | Gold | 1-1376009-1* | 1-1318125-1* |
| 12 | Black | X | 1-1318118-6 | 1-1318114-6 | 1-1318115-6 | Gold | 1376020-1 | 1318125-2 |
| | Black | Y | 2-1318118-6 | 2-1318114-6 | — | Gold | 1376009-2 | 1-1318125-2* |
| | Black | Z | 3-1318118-6 | — | — | Gold | — | 1318126-1 |
| 16 | Black | X | 1-1318118-8 | — | — | Gold | — | 1-1318126-1* |
| | Black | Y | 2-1318118-8 | — | — | Gold | — | 1318126-2 |
| 20 | Black | X | 1-1318118-9 | 1-1318114-9 | 1-1318115-9 | Gold | 1376020-2 | 1-1318126-2* |
| | Black | Y | 2-1318118-9 | 2-1318114-9 | 2-1318115-9 | Gold | 1376137-1 | 1318126-3 |
| | | | | | | | 1376137-2 | 1747994-1 |
| | | | | | | | | 1318127-1 |
| | | | | | | | | 1747994-2 |
| | | | | | | | | 1318127-2 |

*Sequential product
 Note: There is Z-key option in 20-position product, please contact TE sales representative for more information

Relative Product Information

Applicable contact...P.29
 Performance & Specifications ...P.27

Mated Dimension

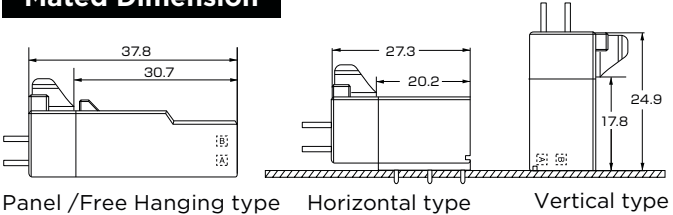

NOTE: All products are RoHS compliant On selection.

D-2100D Double-row Standard Type

External Dimensions

■ Receptacle Housing

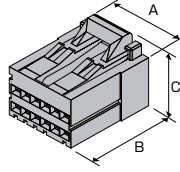

| Pos | Key | Color | Part Number | Dimensions | | |
|-----|-----|-------|-------------|------------|------|------|
| | | | | A | B | C |
| 6 | X | Black | 1-1318119-3 | 8.3 | 20.0 | 15.8 |
| | Y | Black | 2-1318119-3 | | | |
| 8 | X | Black | 1-1318119-4 | 10.8 | 20.0 | 15.8 |
| | Y | Black | 2-1318119-4 | | | |
| 12 | X | Black | 1-1318118-6 | 15.8 | 20.0 | 14.8 |
| | Y | Black | 2-1318118-6 | | | |
| | Z | Black | 3-1318118-6 | | | |
| 16 | X | Black | 1-1318118-8 | 20.8 | 20.0 | 14.8 |
| | Y | Black | 2-1318118-8 | | | |
| 20 | X | Black | 1-1318118-9 | 25.8 | 20.0 | 14.8 |
| | Y | Black | 2-1318118-9 | | | |

■ Tab Housing

Panel type

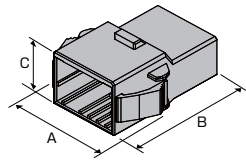

| Pos | Key | Color | Part Number | Dimensions | | |
|-----|-----|-------|-------------|------------|------|------|
| | | | | A | B | C |
| 6 | X | Black | 1-1318114-3 | 19.7 | 30.7 | 13.2 |
| | Y | Black | 2-1318114-3 | | | |
| 8 | X | Black | 1-1318114-4 | 22.2 | 30.7 | 13.2 |
| | Y | Black | 2-1318114-4 | | | |
| 12 | X | Black | 1-1318114-6 | 27.2 | 30.7 | 13.2 |
| | Y | Black | 2-1318114-6 | | | |
| 20 | X | Black | 1-1318114-9 | 37.2 | 30.7 | 13.2 |
| | Y | Black | 2-1318114-9 | | | |

NOTE: All products are RoHS compliant On selection.

■ Tab Housing

Free Hanging type

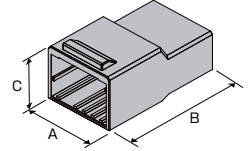

| Pos | Key | Plating | Color | Part Number | Dimensions | | |
|-----|-----|---------|-------|-------------|------------|------|------|
| | | | | | A | B | C |
| 6 | X | Gold | Black | 1-1318115-3 | 10.2 | 30.7 | 10.7 |
| | Y | Gold | Black | 2-1318115-3 | | | |
| 8 | X | Gold | Black | 1-1318115-4 | 12.7 | 30.7 | 10.7 |
| | Y | Gold | Black | 2-1318115-4 | | | |
| 12 | X | Gold | Black | 1-1318115-6 | 17.7 | 30.7 | 10.7 |
| 20 | X | Gold | Black | 1-1318115-9 | 27.7 | 30.7 | 10.7 |
| | Y | Gold | Black | 2-1318115-9 | | | |

■ Board-Mounting Header

Horizontal type

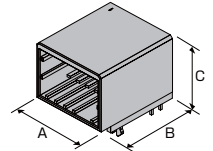

| Pos | Key | Plating | Color | Part Number | Dimensions | | |
|-----|-----|---------|-------|---------------------------|------------|------|------|
| | | | | | A | B | C |
| 6 | X | Gold | Black | 1376136-1 | 10.2 | 20.2 | 14.7 |
| | Y | Gold | Black | 1376136-2 | | | |
| 8 | X | Gold | Black | 1376009-1 1-1376009-1* | 12.7 | 20.2 | 14.7 |
| | Y | Gold | Black | 1376009-2 | | | |
| 12 | X | Gold | Black | 1376020-1 | 17.7 | 20.2 | 14.7 |
| | Y | Gold | Black | 1376020-2 | | | |
| 20 | X | Gold | Black | 1376137-1 | 27.7 | 20.2 | 14.7 |
| | Y | Gold | Black | 1376137-2 | | | |

*Sequential

Vertical type

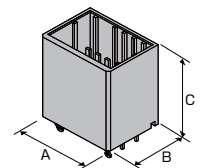

| Pos | Key | Plating | Color | Part Number | Dimensions | | |
|-----|-----|---------|-------|---------------------------|------------|------|------|
| | | | | | A | B | C |
| 6 | X | Gold | Black | 1318124-1 | 10.2 | 13.2 | 17.8 |
| | Y | Gold | Black | 1318124-2 | | | |
| 8 | X | Gold | Black | 1318125-1 1-1318125-1* | 12.7 | 13.2 | 17.8 |
| | Y | Gold | Black | 1318125-2 1-1318125-2* | | | |
| 12 | X | Gold | Black | 1318126-1 1-1318126-1* | 17.7 | 13.2 | 17.8 |
| | Y | Gold | Black | 1318126-2 1-1318126-2* | | | |
| | Z | Gold | Black | 1318126-3 | | | |
| 16 | X | Gold | Black | 1747994-1 | 22.7 | 13.2 | 17.8 |
| | Y | Gold | Black | 1747994-2 | | | |
| 20 | X | Gold | Black | 1318127-1 | 27.7 | 13.2 | 17.8 |
| | Y | Gold | Black | 1318127-2 | | | |

*Sequential

D-2100M Double-row Standard Multipostion Type (Drawer)

Type Chart

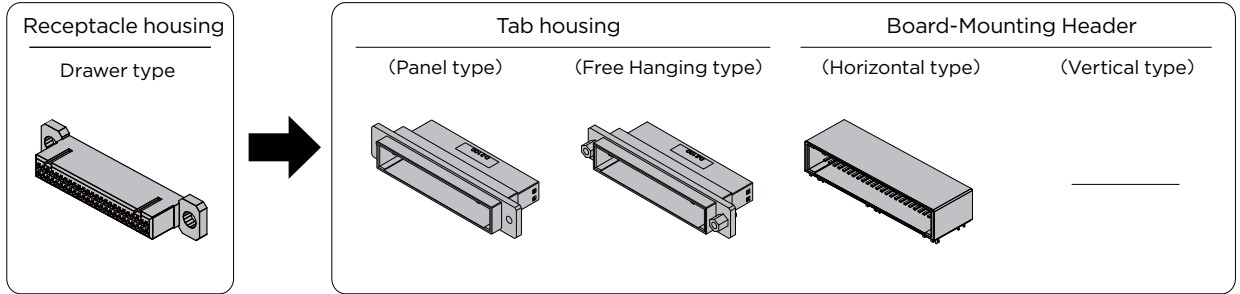

| Pos | Color | Key | Receptacle housing | | Tab housing | | Plating | Board-Mounting Header | |
|-----|-------|-----|--------------------|-------------|------------------------------------|-------------------|---------|-----------------------|---------------|
| | | | Type | Part Number | Panel type | Free Hanging type | | Horizontal type | Vertical type |
| 50 | Black | — | Drawer | 1318577-1 | 1318578-1 1318578-2 (with nuts) | — | Gold | 1318579-1 | — |
| | Black | — | Threaded drawer | 1376072-2 | — | 1376073-2 | — | — | — |

Relative Product Information

Applicable contact...P.29
 Performance & Specifications ...P.27
 Accessories ...P.112

Mated Dimension

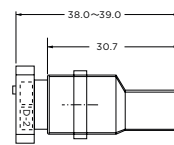

Panel type/Free Hanging type

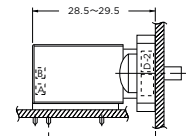

Horizontal type

External Dimensions

- Receptacle Housing
- Socket Accessories (with screws)

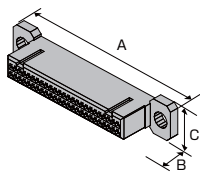

| Pos | Key | Color | Part Number | Dimensions | | |
|-----|-----|-------|-------------|------------|------|------|
| | | | | A | B | C |
| 50 | — | Black | 1318577-1 | 88.5 | 20.0 | 16.6 |
| 50 | — | Black | 1376072-2 | 88.5 | 32.0 | 16.6 |

■ Tab Housing

Panel type

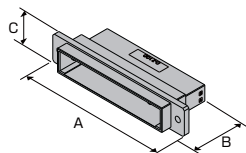

| Pos | Key | Color | Part Number | Dimensions | | |
|-----|-----|-------|----------------------|------------|------|------|
| | | | | A | B | C |
| 50 | — | Black | 1318578-1 | 86.1 | 30.7 | 15.9 |
| | — | Black | 1318578-2(with nuts) | | | |

■ Receptacle Assembly (with screws)

Free Hanging type

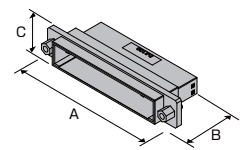

| Pos | Key | Color | Part Number | Dimensions | | |
|-----|-----|-------|-------------|------------|------|------|
| | | | | A | B | C |
| 50 | — | Black | 1376073-2 | 86.1 | 30.7 | 15.9 |

■ Board-Mounting Header

Horizontal type

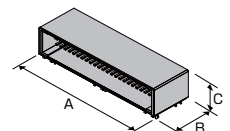

| Pos | Key | Plating | Color | Part Number | Dimensions | | |
|-----|-----|---------|-------|-------------|------------|------|------|
| | | | | | A | B | C |
| 50 | — | Gold | Black | 1318579-1 | 68.5 | 21.1 | 15.4 |

NOTE: All products are RoHS compliant On selection.

D-2600D Double-row Hybrid Type

Type Chart

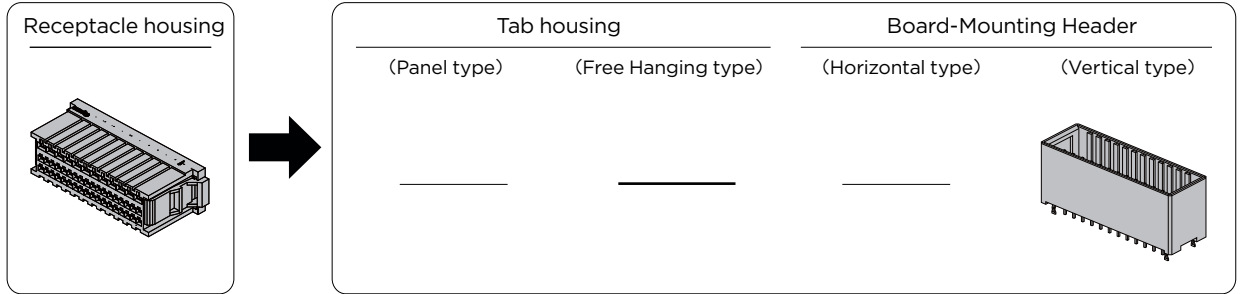

| Pos | Color | Key | Receptacle housing | Tab housing | | Plating | Board-Mounting Header | |
|-----|-------|-----|--------------------|-------------|-------------------|---------|-----------------------|---------------|
| | | | | Panel type | Free Hanging type | | Horizontal type | Vertical type |
| 48* | Black | — | 1827540-1 | — | — | Gold | — | 1827538-1 |

*36 D2000 contacts and 12 D3000 contacts are used in combination

Relative Product Information

Applicable contact...P.29, 39
Performance & Specifications ...P.27, 36

Mated Dimension

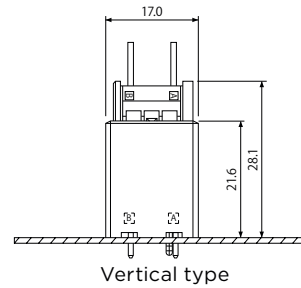

External Dimensions

■ Receptacle Housing

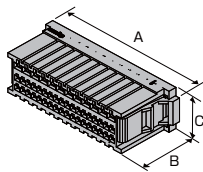

| Pos | Key | Plating | Color | Part Number | Dimensions | | |
|-----|-----|---------|-------|-------------|------------|------|------|
| | | | | | A | B | C |
| 48 | — | — | Black | 1827540-1 | 58.7 | 22.8 | 15.8 |

■ Board-Mounting Header

Vertical type

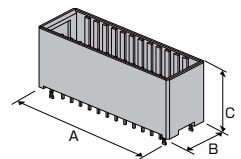

| Pos | Key | Plating | Color | Part Number | Dimensions | | |
|-----|-----|---------|-------|-------------|------------|------|------|
| | | | | | A | B | C |
| 48 | — | Gold | Black | 1827538-1 | 55.9 | 18.0 | 21.6 |

D-3000 Series

Series introduction

The 3000 series is the main Dynamic Series. They are widely used as industrial 'signal' and 'power' connectors.

Pin layout comes in three types: standard 3.81mm pitch, high voltage 5.08mm pitch type and 7.5mm spring clamp type.

The former one is used for signal circuits and the latter two are for high-voltage circuits.

For power source usage, it meets recent demands for small size and high power which comply with miniaturisation of the machinery. The newly developed copper alloy can carry a higher current of 15A per pole despite its small size.

This concept is based on the development strategy of the Dynamic Series to cover as wide a range of solutions for as many customers as possible. This concept makes the D-3000 series terminals fit all D-3000 housings, and the wide variety of which means that it is not necessary for a customer to look outside of this range for every requirement.

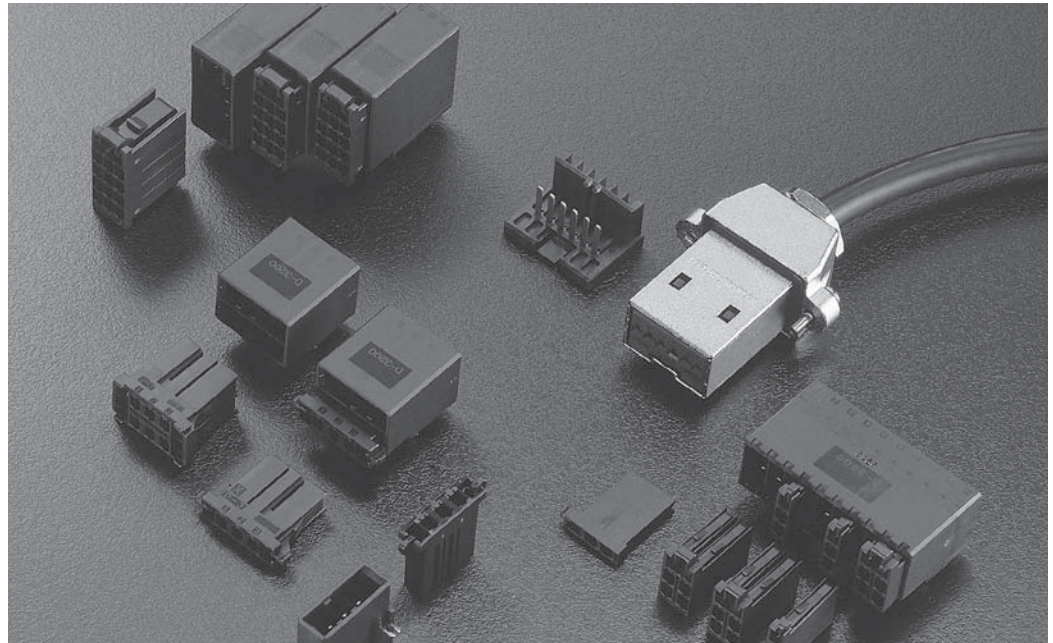

Product Features

1. Anti-twist contact structure

An anti-twist contact structure were developed for motor industry which has 3 contact points when mating receptacle contact with tab contact or header. Concept of 3-contact-points provides high reliability in a real-world environment.

2. Three plating types

3 Plating types are available to meet the customer's cost, performance requirements and applications. Under a normal environment with few mating/unmating requirements, tin plating can be used. Where there is a large number of mating/unmating requirements, then gold plating at 0.38 μm thickness should be used. If the environment is deleterious then gold plating at 0.76 μm thickness can be selected

3. Two types of contact pressure options

2 types of contact pressures are available depending on application: standard Contact pressure for withstanding a large number of mating/unmating requirements or other extreme environments, and high Contact pressure for vibration prone applications

4. High Current

Despite its small size, it conducts up to 15A (at a maximum temperature rise of 30°C). The latest developed copper alloy adds to the reliability of the 3-point contact structure

5. Audible Latching

When mating, a dear 'lock' sound and vibration will be felt by the assembler, that can prevent working 'blind' mis-mating (or halfmating) problems

6. Keying

The housing provides a keying (slit), hence mis-matings can be prevented by using the X and Y keys separately. At the same time, the keying plug can be used to create new key patterns.

3000 Series Performance and Specifications

Performance

| Item | Pitch | 150mil (3.81mm) | 200mil (5.08mm) |
|----------------------|-------|---|--------------------|
| Rated Voltage | | 250V AC/DC | 600V AC/DC |
| Rated Current | | 1 pole:15A 3 pole: 12A 6 pole: 9.5A 16 pole: 8A (AWG#16 for use as powersource) | |
| Contact resistance | | Maximum: 10mff | |
| Withstanding Voltage | | 1,500V AC(1 min) | 2,200V AC(1 min) |
| Temperature | | -55-+105°C | |

Positions/Wire Size/Rated Current

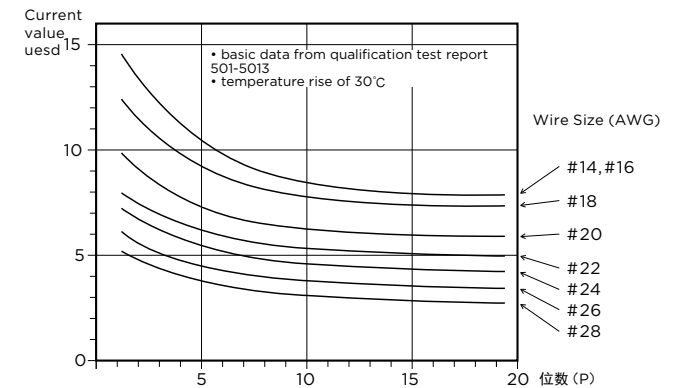

Performance & Specifications

| | |
|--|-----------------------------|
| Product Specifications | 108-5349 |
| Test Report | 501-5013 501-78668(FMLB) |
| Applications Specifications | 114-5148 114-78030(FMLB) |
| Pull tool product number (234168-1) manual | 411-5726 |

| Hand tool manual | |
|---|-----------------|
| Tool product number | Instruction No. |
| 91565-1 91559-1 91558-1 91560-1 91561-1 | 408-8547-1 |

Material and Plating

| Category | Materials | Plating |
|-----------------------------------|--|--|
| Receptacle Contact Tab Contact | Copper alloys | Tin-plating or gold-plating over Nickel under-plated |
| Board Mount Header | Copper alloys | Tin-plating or gold-plating over Nickel under-plated |
| Housing | UL94V-0 thermoplastic PBT with glass fiber, PPS (SMT type), or liquid crystal polymer (motor connector), Black | |

Please order the manual concurrently.

An E-Catalogue is also available for download from the internet

Safety Standards

The safety specifications listed below are approved on specific part numbers. Please contact our Technical Support Centre to check whether the part numbers you use are approved or not. Keep in mind that there are instances where values differ from those given by Tyco Electronics Specifications.

| STD. | Series | D-3100 and D-3400 series (3.81mm pitch) | | | D-3200 and D-3500 series (5.08mm pitch) | | | | | | | | | | | | | | | | | | | | | | | | | | | | | | | | | | | | | | |
|--|--------|--|--|-------------------|--|--|-------------------|----|---|----|---|----|---|----|---|----|---|----|---|----|---|---------------|--------------------|--|-----|---|----|---|----|---|----|---|----|---|----|---|----|---|----|---|----|---|---------------|
| | | Rated Voltage | Rated Current | Temperature Range | Rated Voltage | Rated Current | Temperature Range | | | | | | | | | | | | | | | | | | | | | | | | | | | | | | | | | | | | |
| Product Specifications 108-5349 | | 250V AC/DC | Above table | -55°C -+105°C | 600V AC/DC | Above table | -55°C -+105°C | | | | | | | | | | | | | | | | | | | | | | | | | | | | | | | | | | | | |
| UL File No.E28476 (Recognized Component) | | Based on the requirements of Application | Based on the requirements of Application | - | Based on the requirements of Application | Based on the requirements of Application | - | | | | | | | | | | | | | | | | | | | | | | | | | | | | | | | | | | | | |
| CSA Report No. LR7189 | | 250V AC/DC | Maximum: 8A | - | 250V AC/DC | Maximum: 8A | - | | | | | | | | | | | | | | | | | | | | | | | | | | | | | | | | | | | | |
| TÜV License No. R9151488 (EN61984) IP protection level IP-00 Overvoltage type (II) 50 cycles of repeated plugging and unplugging | | 250V AC 300V DC | <table border="1"> <thead> <tr> <th>AWG</th> <th>A</th> </tr> </thead> <tbody> <tr><td>28</td><td>2</td></tr> <tr><td>26</td><td>3</td></tr> <tr><td>24</td><td>3</td></tr> <tr><td>22</td><td>4</td></tr> <tr><td>20</td><td>5</td></tr> <tr><td>18</td><td>6</td></tr> <tr><td>16</td><td>8</td></tr> <tr><td>14</td><td>8</td></tr> </tbody> </table> | AWG | A | 28 | 2 | 26 | 3 | 24 | 3 | 22 | 4 | 20 | 5 | 18 | 6 | 16 | 8 | 14 | 8 | -20°C -+105°C | 400V AC 300V DC | <table border="1"> <thead> <tr> <th>AWG</th> <th>A</th> </tr> </thead> <tbody> <tr><td>28</td><td>2</td></tr> <tr><td>26</td><td>3</td></tr> <tr><td>24</td><td>3</td></tr> <tr><td>22</td><td>4</td></tr> <tr><td>20</td><td>5</td></tr> <tr><td>18</td><td>6</td></tr> <tr><td>16</td><td>8</td></tr> <tr><td>14</td><td>8</td></tr> </tbody> </table> | AWG | A | 28 | 2 | 26 | 3 | 24 | 3 | 22 | 4 | 20 | 5 | 18 | 6 | 16 | 8 | 14 | 8 | -20°C -+105°C |
| AWG | A | | | | | | | | | | | | | | | | | | | | | | | | | | | | | | | | | | | | | | | | | | |
| 28 | 2 | | | | | | | | | | | | | | | | | | | | | | | | | | | | | | | | | | | | | | | | | | |
| 26 | 3 | | | | | | | | | | | | | | | | | | | | | | | | | | | | | | | | | | | | | | | | | | |
| 24 | 3 | | | | | | | | | | | | | | | | | | | | | | | | | | | | | | | | | | | | | | | | | | |
| 22 | 4 | | | | | | | | | | | | | | | | | | | | | | | | | | | | | | | | | | | | | | | | | | |
| 20 | 5 | | | | | | | | | | | | | | | | | | | | | | | | | | | | | | | | | | | | | | | | | | |
| 18 | 6 | | | | | | | | | | | | | | | | | | | | | | | | | | | | | | | | | | | | | | | | | | |
| 16 | 8 | | | | | | | | | | | | | | | | | | | | | | | | | | | | | | | | | | | | | | | | | | |
| 14 | 8 | | | | | | | | | | | | | | | | | | | | | | | | | | | | | | | | | | | | | | | | | | |
| AWG | A | | | | | | | | | | | | | | | | | | | | | | | | | | | | | | | | | | | | | | | | | | |
| 28 | 2 | | | | | | | | | | | | | | | | | | | | | | | | | | | | | | | | | | | | | | | | | | |
| 26 | 3 | | | | | | | | | | | | | | | | | | | | | | | | | | | | | | | | | | | | | | | | | | |
| 24 | 3 | | | | | | | | | | | | | | | | | | | | | | | | | | | | | | | | | | | | | | | | | | |
| 22 | 4 | | | | | | | | | | | | | | | | | | | | | | | | | | | | | | | | | | | | | | | | | | |
| 20 | 5 | | | | | | | | | | | | | | | | | | | | | | | | | | | | | | | | | | | | | | | | | | |
| 18 | 6 | | | | | | | | | | | | | | | | | | | | | | | | | | | | | | | | | | | | | | | | | | |
| 16 | 8 | | | | | | | | | | | | | | | | | | | | | | | | | | | | | | | | | | | | | | | | | | |
| 14 | 8 | | | | | | | | | | | | | | | | | | | | | | | | | | | | | | | | | | | | | | | | | | |
| Same as above Overvoltage type (III) | | - | Same as above | Same as above | 250V AC 300V DC | Same as above | Same as above | | | | | | | | | | | | | | | | | | | | | | | | | | | | | | | | | | | | |

D-3000 Series Configurations

All connector forms are provided, from the wire-to-wire panel type and free hanging type to the wire-to-board horizontal type and vertical type. Each position can carry a maximum current of up to 15A.

D-3100S Single-row

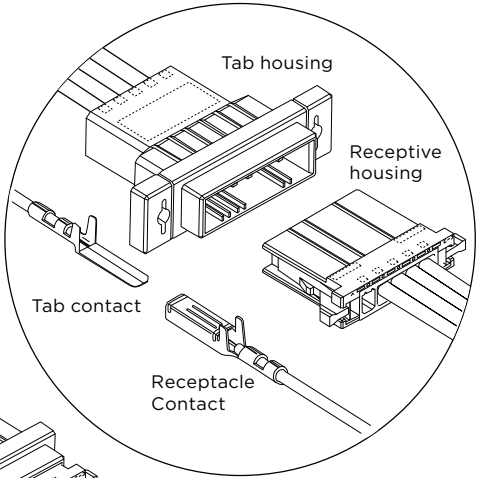

D-3100S
Free Hanging type
(P.40)

D-3100M Standard Modular

D-3100M
PCB mounted
vertical type
(P.46)

D-3100M
PCB Mounted horizontal type
(P.46)

D-3100S
PCB mounted
Vertical type
(P.40)

D-3100S
Panel type
(P.40)

D-3100S PCB Mounted horizontal type
(P.40)

D-3100S SMT
PCB mounted
vertical type
(P.43)

D-3100S SMT
PCB Mounted
horizontal type
(P.43)

Surface mount type
with altered
retention leg shape
and housing
material

D-3100D
PCB Mounted
horizontal type
(P.44)

D-3100D
Free Hanging type
(P.44)

D-3100D Panel type
(P.44)

D-3100D PCB Mounted horizontal type
(P.44)

D-3100D Double-row

All the same forms as
the single-row
standard

D-3000 Series Configurations

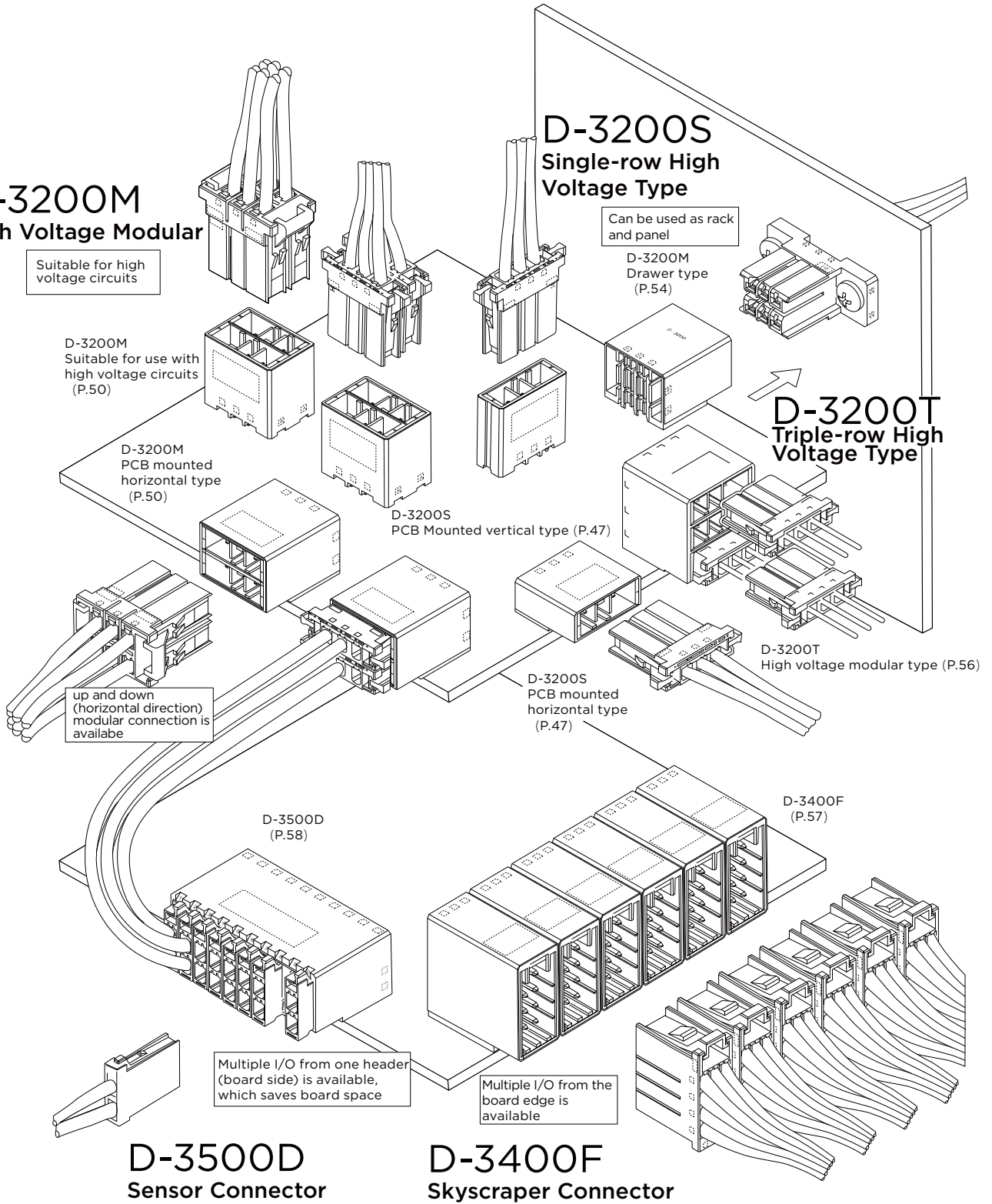

D-3000 Series Contact

■ Crimped Types

Receptacle Contact
(used in receptacle housing)

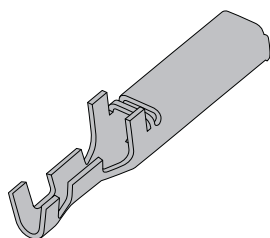

Tab contact
(used in tab housing)

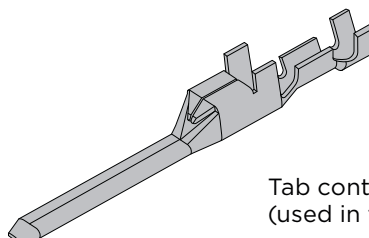

| Wire Range | | Outside Diameter of Insulation mm | Wire Range Mark | Contacts | | | | | Applicable tools | |
|----------------|----------------------|------------------------------------|-----------------|--|------------------------|--------------------------------|-------------|-------------|---|-----------------|
| AWG | mm ² | | | Receptacle Contact | | | Tab Contact | | CCII Hand Tool PEW12 Hand Tool* (PEW12 dice only) | Mini Applicator |
| | | | | | Strip form | Loose Piece | Strip form | Loose Piece | | |
| 28 26 | 0.08 0.12 | 0.8-1.2 | S | Standard contact pressure (gold plating only) | 175194-□ 2298107-1" | 175216-□ 2311162-1" | 175284-□ | 175287-□ | 91565-1 | 2836130-1 |
| 24 | 0.20 | 1.0-1.4 | | High contact pressure | 1-175194-□ | 1-175216-□ | | | | |
| 24 22 20 | 0.20 0.30 0.50 | 1.2-1.6 1.7-2.6 (1.7-2.35)** | M | Standard contact pressure (gold plating only) | 175195-□ 2298107-2" | 175217-□ 2311162-2" FMLB | 175285-□ | 175288-□ | 91559-1 | 2151080-1 |
| | | | | High contact pressure | 1-175195-□ | 1-175217-□ | | | | |
| 20 18 | 0.50 0.85 | 1.8-2.8 | L | Standard contact pressure (gold plating only) | 175196-□ 2298107-3" | 175218-□ 2311162-3" | 175286-□ | 175289-□ | 91558-1 | 2151018-1 |
| 16 | 1.25 | 2.2-2.8 (2.2-2.56)** | | High contact pressure | 1-175196-□ | 1-175218-□ | | | | |
| 16 14 | 1.25 2.20 | 2.2-2.8 | 2L | Standard contact pressure (gold plating only) | 917484-□ 2298107-4" | 917511-□ 2311162-4" | 917485-□ | 917512-□ | 91560-1 | 2151119-1 |
| | | | | High contact pressure | 1-917484-□ | 1-917511-□ | | | | |
| 16 14 | 1.25 2.20 | 3.1-3.3 3.3-3.8 | 3L | Standard contact pressure (gold plating only) | 353715-□ 2298107-5" | 353717-□ 2311162-5" | 353716-□ | 353718-□ | 91561-1 | 2151073-1 |
| | | | | High contact pressure | 1-353715-□ | 1-353717-□ | | | | |

Reference: Plating code

-2: 0.38 μm thickness gold plating

-3: 0.76 μm thickness gold plating

-5: Tin plating (only set to the high contact pressure type)

Strip Form contacts are used with Mini-applicators (bench machine) and Loose-Piece contacts are with hand tools.

Please see 114-5148 for strip form products

* The outer diameter of the insulation is applicable to Loose Piece terminals.

**Sequential (FMLB) female contacts. See 114-78030 in the operating manual.

The receptacle contact can be used in all receptacle housings, while the Tab housing can be used in all tabs housings Details of the applicable tool are available from P.107

NOTE: all products are RoHS compliant On selection.

D-3100S Single-row Standard

Type Chart

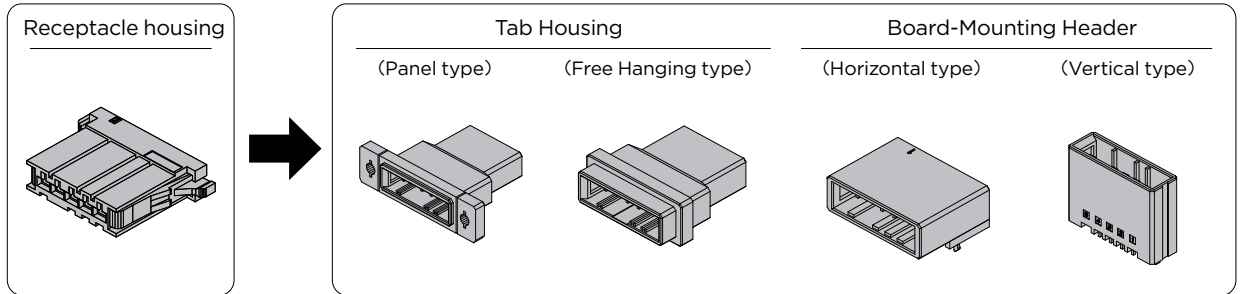

| Pos | Color | Key | Receptacle housing | Tab housing | | | Plating | Board-Mounting Header | | | | | | | |
|-------|------------|------------|--------------------|-------------|-------------------|-----------|------------|-----------------------|---------------|------------|-------------|---|------|------------|------------|
| | | | | Panel type | Free Hanging type | L Bracket | | Horizontal type | Vertical type | | | | | | |
| 2 | Black | X | 1-178128-2 | 1-179553-2 | 1-179552-2 | S | Gold | 1-179276-2 | 1-917337-2 | | | | | | |
| | | | | | | | Gold | 1-179276-3 | 1-917337-3 | | | | | | |
| | | | | | | | Tin | 1-179276-5 | 1-917337-5 | | | | | | |
| | Black | Y | 2-178128-2 | 2-179553-2 | 2-179552-2 | S | Gold | 2-179276-2 | 2-917337-2 | | | | | | |
| | | | | | | | Gold | 2-179276-3 | 2-917337-3 | | | | | | |
| 3 | Black | X | 1-178288-3 | 1-178802-3 | 1-177648-3 | S | Gold | 1-178293-2 | 1-178313-2 | | | | | | |
| | | | | | | | Gold | 1-178293-3 | 1-178313-3 | | | | | | |
| | | | | | | | Tin | 1-178293-5 | 1-178313-5 | | | | | | |
| | Black | Y | 2-178288-3 | 2-178802-3 | 2-177648-3 | S | Gold | 2-178293-2 | 2-178313-2 | | | | | | |
| | | | | | | | Gold | 2-178293-3 | 2-178313-3 | | | | | | |
| | | | | | | | Tin | 2-178293-5 | 2-178313-5 | | | | | | |
| | Black | Z | 3-178128-3 | — | — | — | Tin | — | 3-178136-5 | | | | | | |
| | | | | | | | Black | X | 1-178288-4 | 1-179553-4 | 1-179552-4* | — | Gold | 1-178294-2 | 1-178314-2 |
| | | | | | | | | | | | | | Gold | 1-178294-3 | 1-178314-3 |
| Tin | 1-178294-5 | 1-178314-5 | | | | | | | | | | | | | |
| Black | Y | 2-178288-4 | 2-179553-4 | 2-179552-4* | — | Gold | 2-178294-2 | 2-178314-2 | | | | | | | |
| | | | | | | Gold | 2-178294-3 | 2-178314-3 | | | | | | | |
| | | | | | | Tin | 2-179277-5 | 2-178314-5 | | | | | | | |
| 5 | Black | X | 1-178288-5 | 1-178802-5 | 1-177648-5 | L | Gold | 1-178295-2 | 1-178315-2 | | | | | | |
| | | | | | | | Gold | 1-178295-3 | 1-178315-3 | | | | | | |
| | | | | | | | Tin | 1-178295-5 | 1-178315-5 | | | | | | |
| 6 | Black | X | 1-178288-6 | — | — | — | Gold | 1-178296-2 | 1-178316-2 | | | | | | |
| | | | | | | | Gold | 1-178296-3 | 1-178316-3 | | | | | | |
| | | | | | | | Tin | 1-178296-5 | 1-178316-5 | | | | | | |
| | Black | Y | 2-178288-6 | — | — | — | Gold | 2-178296-2 | 2-178316-2 | | | | | | |
| | | | | | | | Gold | — | 2-178316-3 | | | | | | |
| | | | | | | | Tin | — | 2-178316-5 | | | | | | |
| 8 | Black | X | 1-178288-7 | 1-178802-7 | 1-177648-7 | L | Gold | 1-178297-2 | 1-178317-2 | | | | | | |
| | | | | | | | Gold | 1-178297-3 | 1-178317-3 | | | | | | |
| | | | | | | | Tin | 1-178297-5 | 1-178317-5 | | | | | | |
| 10 | Black | X | 1-178288-8 | 1-178802-8 | 1-177648-8 | L | Gold | 1-178298-2 | 1-178318-2 | | | | | | |
| | | | | | | | Gold | 1-178298-3 | 1-178318-3 | | | | | | |
| | | | | | | | Tin | 1-178298-5 | 1-178318-5 | | | | | | |
| | Black | Y | 2-178288-8 | 2-178802-8 | 2-177648-8 | L | Gold | 2-178298-3 | 2-178318-2 | | | | | | |

*DIN rail attachment is available, P/N 2822900-1

Relative Product Information

Applicable contact...P.39
 Performance & Specifications...P.36
 Accessories...P.112

NOTE: all products are RoHS compliant On selection.

Mated Dimension

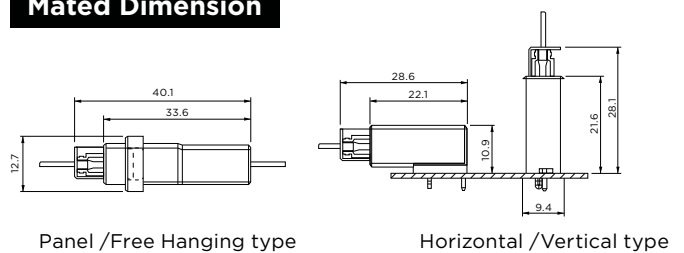

D-3100S Single-row Standard

External Dimensions

■ Receptacle Housing

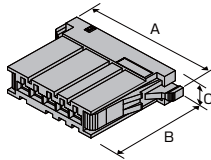

| Pos | Key | Color | Part Number | Dimensions | | |
|-----|-----|-------|-------------|------------|------|-----|
| | | | | A | B | C |
| 2 | X | Black | 1-178128-2 | 24.6 | 22.8 | 7.2 |
| | Y | Black | 2-178128-2 | | | |
| 3 | X | Black | 1-178288-3 | 26.8 | 22.8 | 7.2 |
| | Y | Black | 2-178288-3 | | | |
| | Z | Black | 3-178128-3 | | | |
| 4 | X | Black | 1-178288-4 | 30.6 | 22.8 | 7.2 |
| 5 | X | Black | 1-178288-5 | 34.4 | 22.8 | 7.2 |
| 6 | X | Black | 1-178288-6 | 38.2 | 22.8 | 7.2 |
| | Y | Black | 2-178288-6 | | | |
| 8 | X | Black | 1-178288-7 | 45.8 | 22.8 | 7.2 |
| 10 | X | Black | 1-178288-8 | 53.4 | 22.8 | 7.2 |
| | Y | Black | 2-178288-8 | | | |

■ Tab Housing

Panel type

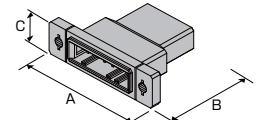

| Pos | Key | Color | Part Number | Dimensions | | |
|-----|-----|-------|-------------|------------|------|------|
| | | | | A | B | C |
| 2 | X | Black | 1-179553-2 | 36.8 | 33.6 | 12.7 |
| | Y | Black | 2-179553-2 | | | |
| 3 | X | Black | 1-178802-3 | 40.0 | 33.6 | 12.7 |
| | Y | Black | 2-178802-3 | | | |
| 4 | X | Black | 1-179553-4 | 47.0 | 33.6 | 12.7 |
| | X | Black | 2-179553-4 | | | |
| 5 | X | Black | 1-178802-5 | 47.0 | 33.6 | 12.7 |
| 8 | X | Black | 1-178802-7 | 59.0 | 33.6 | 12.7 |
| 10 | X | Black | 1-178802-8 | 67.0 | 33.6 | 12.7 |
| | Y | Black | 2-178802-8 | | | |

Free Hanging type

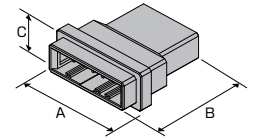

| Pos | Key | Color | Part Number | Dimensions | | |
|-----|-----|-------|-------------|------------|------|------|
| | | | | A | B | C |
| 2 | X | Black | 1-179552-2 | 23.0 | 33.6 | 12.7 |
| | Y | Black | 2-179552-2 | | | |
| 3 | X | Black | 1-177648-3 | 25.6 | 33.6 | 12.7 |
| | Y | Black | 2-177648-3 | | | |
| 4 | X | Black | 1-179552-4 | 33.2 | 33.6 | 12.7 |
| | X | Black | 2-179552-4 | | | |
| 5 | X | Black | 1-177648-5 | 33.2 | 33.6 | 12.7 |
| 8 | X | Black | 1-177648-7 | 44.6 | 33.6 | 12.7 |
| 10 | X | Black | 1-177648-8 | 52.2 | 33.6 | 12.7 |
| | Y | Black | 2-177648-8 | | | |

Applications

Example of elevator applications

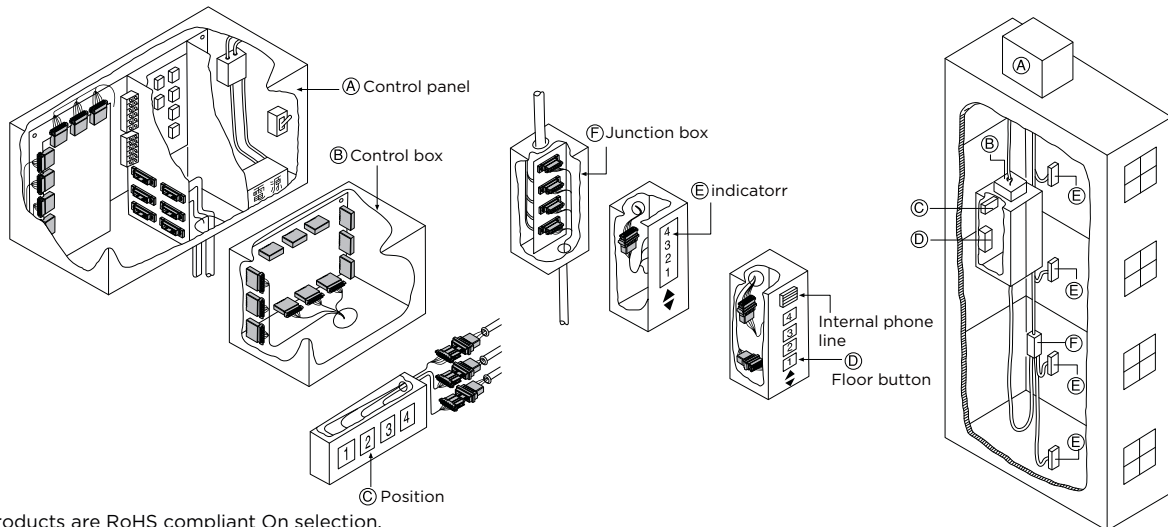

NOTE: all products are RoHS compliant On selection.

D-3100S Single-row Standard

Board-Mounting Header

Horizontal type

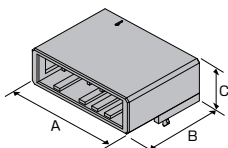

| Pos | Key | Plating | Color | Part Number | Dimensions | | |
|-----|-----|---------|-------|-------------|------------|------|------|
| | | | | | A | B | C |
| 2 | X | Gold | Black | 1-179276-2 | 19.1 | 22.1 | 10.9 |
| | | Gold | Black | 1-179276-3 | | | |
| | | Tin | Black | 1-179276-5 | | | |
| | Y | Gold | Black | 2-179276-2 | | | |
| | | Gold | Black | 2-179276-3 | | | |
| | | Gold | Black | 2-179276-3 | | | |
| 3 | X | Gold | Black | 1-178293-2 | 21.6 | 22.1 | 10.9 |
| | | Gold | Black | 1-178293-3 | | | |
| | | Tin | Black | 1-178293-5 | | | |
| | Y | Gold | Black | 2-178293-2 | | | |
| | | Gold | Black | 2-178293-3 | | | |
| | | Tin | Black | 2-178293-5 | | | |
| 4 | X | Gold | Black | 1-178294-2 | 25.4 | 22.1 | 10.9 |
| | | Gold | Black | 1-178294-3 | | | |
| | | Tin | Black | 1-178294-5 | | | |
| | Y | Gold | Black | 2-178294-2 | | | |
| 5 | X | Gold | Black | 1-178295-2 | 29.2 | 22.1 | 10.9 |
| | | Gold | Black | 1-178295-3 | | | |
| | | Tin | Black | 1-178295-5 | | | |
| 6 | X | Gold | Black | 1-178296-2 | 33.1 | 22.1 | 10.9 |
| | | Gold | Black | 1-178296-3 | | | |
| | | Tin | Black | 1-178296-5 | | | |
| | Y | Gold | Black | 2-178296-2 | | | |
| 8 | X | Gold | Black | 1-178297-2 | 40.7 | 22.1 | 10.9 |
| | | Gold | Black | 1-178297-3 | | | |
| | | Tin | Black | 1-178297-5 | | | |
| | | Gold | Black | 1-178298-2 | | | |
| 10 | X | Gold | Black | 1-178298-3 | 48.3 | 22.1 | 10.9 |
| | | Gold | Black | 1-178298-5 | | | |
| | | Tin | Black | 1-178298-5 | | | |
| | Y | Gold | Black | 2-178298-3 | | | |

Board-Mounting Header

Vertical type

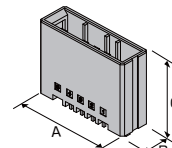

| Pos | Key | Plating | Color | Part Number | Dimensions | | |
|-----|-----|---------|-------|-------------|------------|-----|------|
| | | | | | A | B | C |
| 2 | X | Gold | Black | 1-917337-2 | 19.1 | 9.4 | 21.6 |
| | | Gold | Black | 1-917337-3 | | | |
| | | Tin | Black | 1-917337-5 | | | |
| | Y | Gold | Black | 2-917337-2 | | | |
| | | Gold | Black | 2-917337-3 | | | |
| | | Tin | Black | 2-917337-5 | | | |
| 3 | X | Gold | Black | 1-178313-2 | 21.6 | 9.4 | 21.6 |
| | | Gold | Black | 1-178313-3 | | | |
| | | Tin | Black | 1-178313-5 | | | |
| | Y | Gold | Black | 2-178313-2 | | | |
| | | Gold | Black | 2-178313-3 | | | |
| | | Tin | Black | 2-178313-5 | | | |
| 4 | X | Tin | Black | 3-178136-5 | 25.4 | 9.4 | 21.6 |
| | | Gold | Black | 1-178314-2 | | | |
| | | Gold | Black | 1-178314-3 | | | |
| | Y | Tin | Black | 1-178314-5 | | | |
| 5 | X | Gold | Black | 1-178314-2 | 29.2 | 9.4 | 21.6 |
| | | Gold | Black | 1-178314-3 | | | |
| | | Tin | Black | 1-178314-5 | | | |
| | Y | Gold | Black | 2-178314-2 | | | |
| 6 | X | Gold | Black | 1-178315-2 | 33.1 | 9.4 | 21.6 |
| | | Gold | Black | 1-178315-3 | | | |
| | | Tin | Black | 1-178315-5 | | | |
| | Y | Gold | Black | 2-178316-2 | | | |
| 8 | X | Tin | Black | 1-178316-5 | 40.7 | 9.4 | 21.6 |
| | | Gold | Black | 1-178316-2 | | | |
| | | Gold | Black | 2-178316-3 | | | |
| | Y | Gold | Black | 2-178316-3 | | | |
| 10 | X | Tin | Black | 2-178316-5 | 48.3 | 9.4 | 21.6 |
| | | Gold | Black | 1-178317-2 | | | |
| | | Gold | Black | 1-178317-3 | | | |
| | Y | Gold | Black | 2-178318-2 | | | |

NOTE: all products are RoHS compliant On selection.



D-3100S Single-row SMT Types

Type Chart

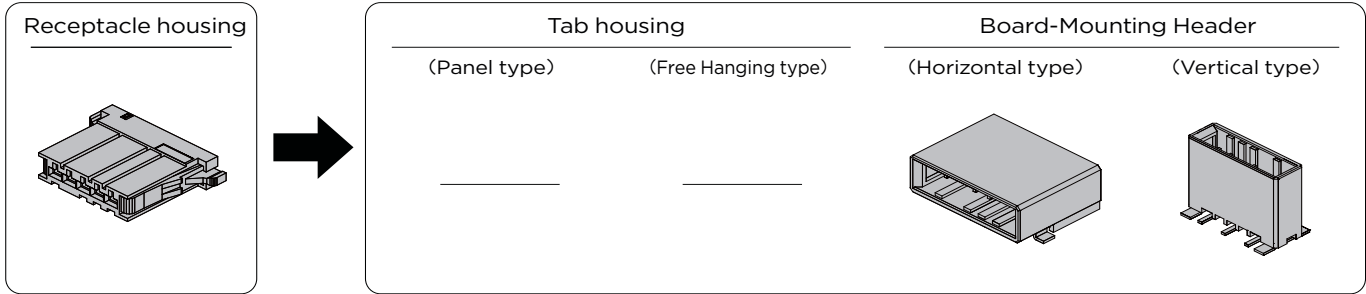

| Pos | Color | Key | Receptacle housing | Tab housing | | Plating | Board-Mounting Header | |
|-----|-------|-----|--------------------|-------------|-------------------|---------|-----------------------|---------------|
| | | | | Panel type | Free Hanging type | | Horizontal type | Vertical type |
| 5 | Black | X | 1-178288-5 | — | — | Gold | 1-177662-2 | 1-177665-2 |
| | | | | | | | 1-2343327-2* | |
| 8 | Black | X | 1-178288-7 | — | — | Gold | 1-179188-2 | — |
| | | | | | | | 1-179188-3 | |

* In reel package

Mated Dimension

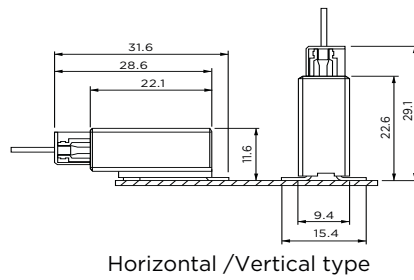

Horizontal /Vertical type

External Dimensions

Receptacle Housing

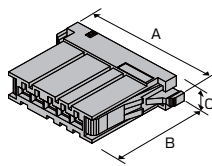

| Pos | Key | Color | Part Number | Dimensions | | |
|-----|-----|-------|-------------|------------|------|-----|
| | | | | A | B | C |
| 5 | X | Black | 1-178288-5 | 34.4 | 22.8 | 7.2 |
| 8 | X | Black | 1-178288-7 | 45.8 | 22.8 | 7.2 |

Board-Mounting Header

Horizontal type

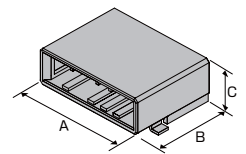

| Pos | Key | Plating | Color | Part Number | Dimensions | | |
|-----|-----|---------|-------|-------------|------------|------|------|
| | | | | | A | B | C |
| 5 | X | Gold | Black | 1-177662-2 | 29.2 | 22.1 | 11.6 |
| 8 | X | Gold | Black | 1-179188-2 | 40.7 | 22.1 | 11.6 |
| | | Gold | Black | 1-179188-3 | | | |

Vertical type

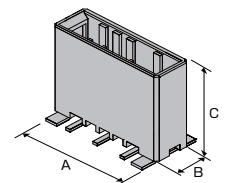

| Pos | Key | Plating | Color | Part Number | Dimensions | | |
|-----|-----|---------|-------|-------------|------------|-----|------|
| | | | | | A | B | C |
| 5 | X | Gold | Black | 1-177665-2 | 29.2 | 9.4 | 22.6 |

NOTE: all products are RoHS compliant On selection.

D-3100D Double-row Standard Type

Type Chart

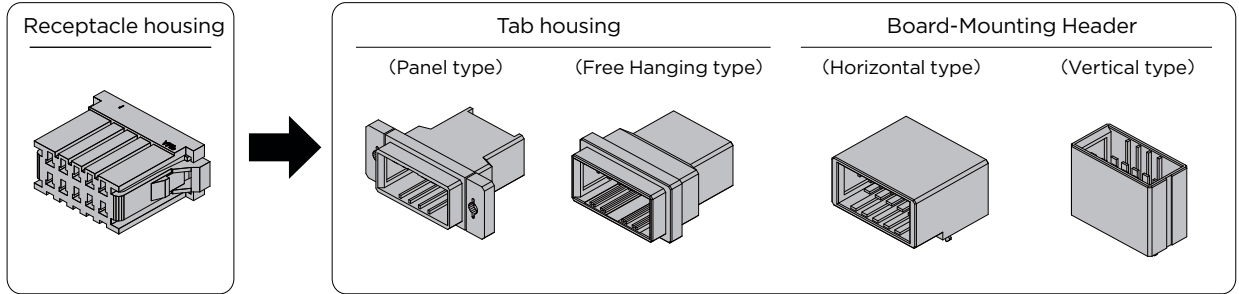

| Pos | Color | Key | Receptacle housing | Tab housing | | | Plating | Board-Mounting Header | |
|-----|-------|-----|--------------------|-------------|-------------------|-----------|---------|-----------------------|---------------|
| | | | | Panel type | Free Hanging type | L Bracket | | Horizontal type | Vertical type |
| 6 | Black | X | 178289-3 | 178803-3 | 178964-3 | S | Gold | 178303-2 | 178323-2 |
| | | | | | | | Gold | 178303-3 | 178323-3 |
| | | | | | | | Tin | 178303-5 | 178323-5 |
| 8 | Black | X | 178289-4 | — | 178964-4 | S | Gold | 1717412-2 | 1903601-2 |
| | | | | | | | Tin | — | 1903601-5 |
| | | | | | | | Gold | 178305-2 | 178325-2 |
| 10 | Black | X | 178289-5 | 178803-5 | 178964-5 | L | Gold | 178305-3 | 178325-3 |
| | | | | | | | Tin | 178305-5 | 178325-5 |
| | | | | | | | Gold | 178306-2 | 178326-2 |
| 12 | Black | X | 178289-6 | 178803-6 | 178964-6 | L | Gold | 178306-3 | 178326-3 |
| | | | | | | | Tin | 178306-5 | 178326-5 |
| | | | | | | | Gold | 178307-2 | 178327-2 |
| 16 | Black | X | 178289-7 | 178803-7 | 178964-7 | L | Gold | 178307-3 | 178327-3 |
| | | | | | | | Tin | 178307-5 | 178327-5 |
| | | | | | | | Gold | 178308-2 | 178328-2 |
| 20 | Black | X | 178289-8 | 178803-8 | 178964-8 | L | Gold | 178308-3 | 178328-3 |
| | | | | | | | Tin | 178308-5 | 178328-5 |

Relative Product Information

Applicable contact...P.39
 Performance & Specifications...P.36
 Accessories...P.112

Mated Dimension

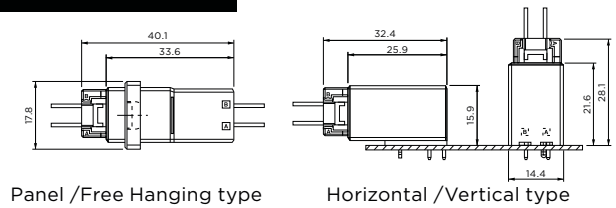

Applications

Example of Programmable Controller Application

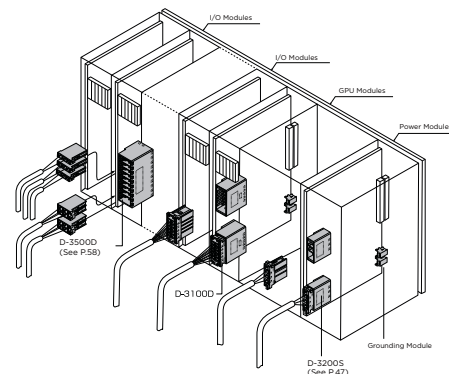

NOTE: all products are RoHS compliant On selection.

D-3100D Double-row Standard Type

External Dimensions

■ Receptacle Housing

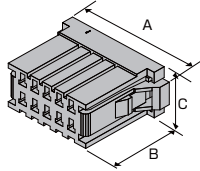

| Pos | Key | Color | Part Number | Dimensions | | |
|-----|-----|-------|-------------|------------|------|------|
| | | | | A | B | C |
| 6 | X | Black | 178289-3 | 24.4 | 22.8 | 12.5 |
| 8 | X | Black | 178289-4 | 28.2 | 22.8 | 12.5 |
| 10 | X | Black | 178289-5 | 32.0 | 22.8 | 12.5 |
| 12 | X | Black | 178289-6 | 35.8 | 22.8 | 12.5 |
| 16 | X | Black | 178289-7 | 42.7 | 22.8 | 12.5 |
| 20 | X | Black | 178289-8 | 51.0 | 22.8 | 12.5 |

■ Tab Housing

Panel type

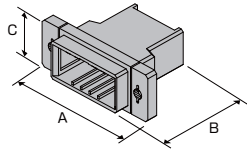

| Pos | Key | Color | Part Number | Dimensions | | |
|-----|-----|-------|-------------|------------|------|------|
| | | | | A | B | C |
| 6 | X | Black | 178803-3 | 40.0 | 33.6 | 17.8 |
| 10 | X | Black | 178803-5 | 47.0 | 33.6 | 17.8 |
| 12 | X | Black | 178803-6 | 51.0 | 33.6 | 17.8 |
| 16 | X | Black | 178803-7 | 59.0 | 33.6 | 17.8 |
| 20 | X | Black | 178803-8 | 67.0 | 33.6 | 17.8 |

Free Hanging type

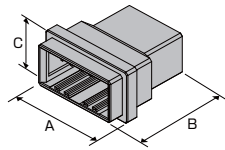

| Pos | Key | Color | Part Number | Dimensions | | |
|-----|-----|-------|-------------|------------|------|------|
| | | | | A | B | C |
| 6 | X | Black | 178964-3 | 25.6 | 33.6 | 17.8 |
| 8 | X | Black | 178964-4 | 29.4 | 33.6 | 17.8 |
| 10 | X | Black | 178964-5 | 33.2 | 33.6 | 17.8 |
| 12 | X | Black | 178964-6 | 37.0 | 33.6 | 17.8 |
| 16 | X | Black | 178964-7 | 44.6 | 33.6 | 17.8 |
| 20 | X | Black | 178964-8 | 52.2 | 33.6 | 17.8 |

NOTE: all products are RoHS compliant On selection.

■ Board-Mounting Header

Horizontal type

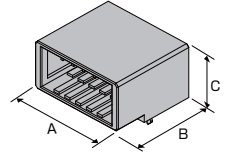

| Pos | Key | Plating | Color | Part Number | Dimensions | | |
|-----|-----|---------|-------|-------------|------------|------|------|
| | | | | | A | B | C |
| 6 | X | Gold | Black | 178303-2 | 21.6 | 25.9 | 15.9 |
| | X | Gold | Black | 178303-3 | | | |
| | X | Tin | Black | 178303-5 | | | |
| 8 | X | Gold | Black | 1717412-2 | 25.4 | 25.9 | 15.9 |
| | X | Gold | Black | 1717412-3 | | | |
| 10 | X | Gold | Black | 178305-2 | 29.2 | 25.9 | 15.9 |
| | X | Gold | Black | 178305-3 | | | |
| | X | Tin | Black | 178305-5 | | | |
| 12 | X | Gold | Black | 178306-2 | 33.1 | 25.9 | 15.9 |
| | X | Gold | Black | 178306-3 | | | |
| | X | Tin | Black | 178306-5 | | | |
| 16 | X | Gold | Black | 178307-2 | 40.7 | 25.9 | 15.9 |
| | X | Gold | Black | 178307-3 | | | |
| | X | Tin | Black | 178307-5 | | | |
| 20 | X | Gold | Black | 178308-2 | 48.3 | 25.9 | 15.9 |
| | X | Gold | Black | 178308-3 | | | |
| | X | Tin | Black | 178308-5 | | | |

Vertical type

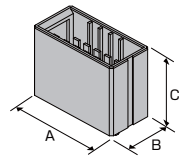

| Pos | Key | Plating | Color | Part Number | Dimensions | | |
|-----|-----|---------|-------|-------------|------------|------|------|
| | | | | | A | B | C |
| 6 | X | Gold | Black | 178323-2 | 21.6 | 14.4 | 21.6 |
| | X | Gold | Black | 178323-3 | | | |
| | X | Tin | Black | 178323-5 | | | |
| 8 | X | Gold | Black | 1903601-2 | 25.4 | 14.4 | 21.6 |
| | X | Tin | Black | 1903601-5 | | | |
| 10 | X | Gold | Black | 178325-2 | 29.2 | 14.4 | 21.6 |
| | X | Gold | Black | 178325-3 | | | |
| | X | Tin | Black | 178325-5 | | | |
| 12 | X | Gold | Black | 178326-2 | 33.1 | 14.4 | 21.6 |
| | X | Gold | Black | 178326-3 | | | |
| 16 | X | Tin | Black | 178326-5 | 40.7 | 14.4 | 21.6 |
| | X | Gold | Black | 178327-2 | | | |
| | X | Gold | Black | 178327-3 | | | |
| 20 | X | Tin | Black | 178327-5 | 48.3 | 14.4 | 21.6 |
| | X | Gold | Black | 178328-2 | | | |
| | X | Gold | Black | 178328-3 | | | |
| | X | Tin | Black | 178328-5 | | | |

D-3100M Double-row Standard Modular Type

Type Chart

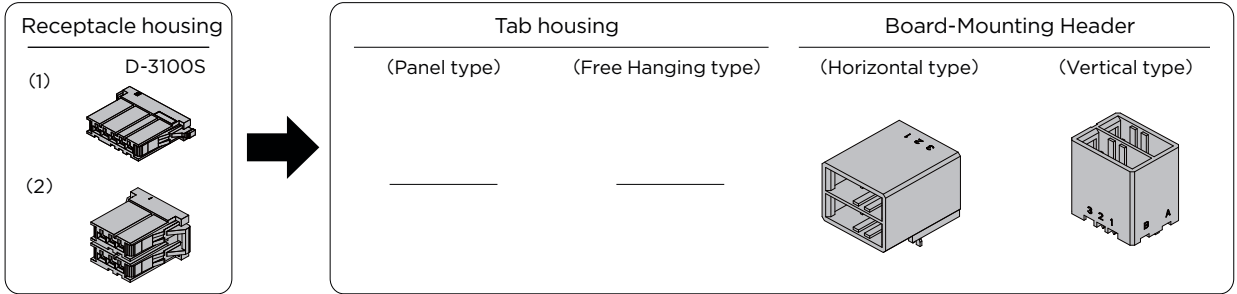

| Pos | Color | Key | Receptacle housing | | Tab housing | | Plating | Board-Mounting Header | |
|-------|-------|----------------------------------|--------------------|----------------|-------------|-------------------|------------|-----------------------|---------------|
| | | | 1 row 3 pos.1 | 1 row 6 pos. | Panel type | Free Hanging type | | Horizontal type | Vertical type |
| 6 | Black | XX | 1-178288-3 (2) | 1-178127-6 (1) | — | — | Gold | 1-178137-2 | 1-178141-2 |
| | | | | | — | — | Gold | 1-178137-3 | 1-178141-3 |
| | | | | | — | — | Tin | 1-178137-5 | 1-178141-5 |
| | Black | YY | 2-178288-3 (2) | 2-178127-6 (1) | — | — | Gold | 2-178137-2 | — |
| | | | | | — | — | Tin | 2-178137-5 | |
| | | | | | — | — | Gold | 3-178137-2 | |
| Black | XY | 1-178288-3 (1) 2-178288-3 (1) | 3-178127-6 (1) | — | — | Gold | 3-178137-2 | 3-178141-2 | |
| | | | | — | — | Gold | 3-178137-3 | 3-178141-3 | |
| | | | | — | — | Tin | 3-178137-5 | 3-178141-5 | |

Relative Product Information

Applicable contact...P.39
Performance & Specifications ...P.36

Mated Dimension

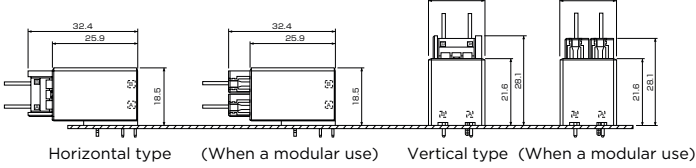

External Dimensions

Receptacle Housing

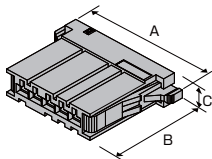

| Pos | Key | Color | Part Number | Dimensions | | |
|-----|-----|-------|-------------|------------|------|-----|
| | | | | A | B | C |
| 3 | X | Black | 1-178288-3 | 26.8 | 22.8 | 7.2 |
| | Y | Black | 2-178288-3 | | | |

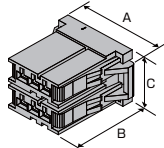

| Pos | Key | Color | Part Number | Dimensions | | |
|-----|-----|-------|-------------|------------|------|------|
| | | | | A | B | C |
| 6 | XX | Black | 1-178127-6 | 24.8 | 22.8 | 14.8 |
| | YY | Black | 2-178127-6 | | | |
| | XY | Black | 3-178127-6 | | | |

NOTE: all products are RoHS compliant On selection.

Board-Mounting Header

Horizontal type

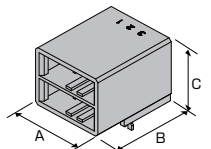

| Pos | Key | Plating | Color | Part Number | Dimensions | | |
|------|-------|---------|------------|-------------|------------|------|------|
| | | | | | A | B | C |
| 6 | XX | Gold | Black | 1-178137-2 | 21.6 | 25.9 | 18.5 |
| | | Gold | Black | 1-178137-3 | | | |
| | | Tin | Black | 1-178137-5 | | | |
| | YY | Gold | Black | 2-178137-2 | | | |
| | | Tin | Black | 2-178137-5 | | | |
| | | XY | Gold | Black | | | |
| Gold | Black | | 3-178137-3 | | | | |
| | Tin | Black | 3-178137-5 | | | | |

Vertical type

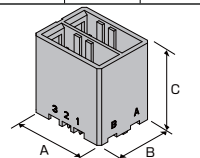

| Pos | Key | Plating | Color | Part Number | Dimensions | | |
|-----|-----|---------|-------|-------------|------------|------|------|
| | | | | | A | B | C |
| 6 | XX | Gold | Black | 1-178141-2 | 21.6 | 17.0 | 21.6 |
| | | Gold | Black | 1-178141-3 | | | |
| | | Tin | Black | 1-178141-5 | | | |
| | XY | Gold | Black | 3-178141-2 | | | |
| | | Gold | Black | 3-178141-3 | | | |
| | | Tin | Black | 3-178141-5 | | | |

D-3200S Single-row High Voltage Type

Type Chart

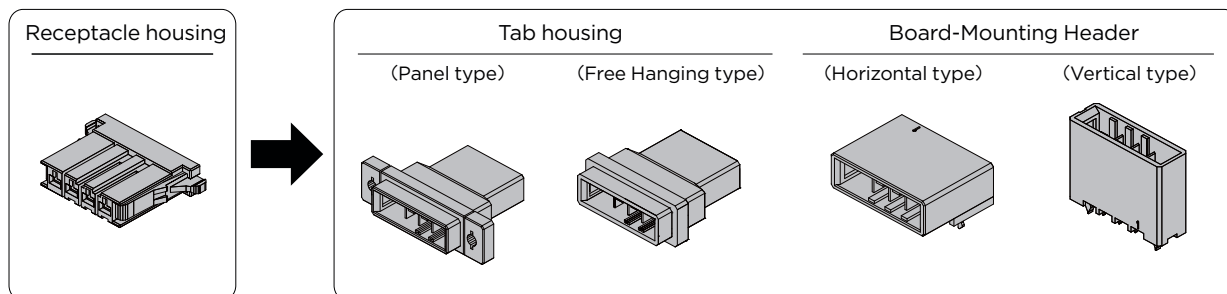

| Pos | Color | Key | Receptacle housing | Tab housing | | | Plating | Board-Mounting Header | |
|-------|------------|------------|--------------------|-------------|-------------------|-----------|---------|-----------------------|---------------|
| | | | | Panel type | Free Hanging type | L Bracket | | Horizontal type | Vertical type |
| 2 | Black | X | 1-178128-2 | 1-179553-2 | 1-179552-2 | S | Gold | 1-179276-2 | 1-917337-2 |
| | | | | | | | Gold | 1-179276-3 | 1-917337-3 |
| | Black | Y | 2-178128-2 | 2-179553-2 | 2-179552-2 | S | Tin | 1-179276-5 | 1-917337-5 |
| | | | | | | | Gold | 2-179276-2 | 2-917337-2 |
| 3 | Black | X | 1-178128-3 | 1-179553-3 | 1-179552-3 | S | Gold | 1-178138-2 | 1-178136-2 |
| | | | | | | | Gold | 1-178138-3 | 1-178136-3 |
| | | | | | | | Tin | 1-178138-5 | 1-178136-5 |
| | Black | Y | 2-178128-3 | 2-179553-3 | 2-179552-3 | S | Gold | 2-178138-2 | 2-178136-2 |
| | | | | | | | Gold | 2-178138-3 | 2-178136-3 |
| | | | | | | | Tin | 2-178138-5 | 2-178136-5 |
| Black | Z | 3-178128-3 | — | — | — | Tin | — | 3-178136-5 | |
| | | | | | | 4 | Black | X | 1-178128-4 |
| Gold | 1-179277-3 | 1-917338-3 | | | | | | | |
| Tin | 1-179277-5 | 1-917338-5 | | | | | | | |
| Black | Y | 2-178128-4 | 2-179553-4 | 2-179552-4 | S | | Gold | 2-179277-2 | 2-917338-2 |
| | | | | | | | Gold | 2-179277-3 | 2-917338-3 |
| | | | | | | | Tin | 2-179277-5 | 2-917338-5 |
| 5 | Black | X | 1-178128-5 | — | — | — | Gold | 1-316130-2 | 1-316132-2 |
| | | | | | | | Gold | 1-316130-3 | 1-316132-3 |
| | Black | Y | 2-178128-5 | — | — | — | Tin | 1-316130-5 | 1-316132-5 |
| | | | | | | | Gold | 2-316130-2 | 2-316132-2 |
| 6 | Black | X | 1-178128-6 | — | — | — | Gold | 2-316130-3 | 2-316132-3 |
| | | | | | | | Gold | 1-316131-2 | 1-316133-2 |
| | | | | | | | Tin | 1-316131-3 | 1-316133-3 |
| | Black | Y | 2-178128-6 | — | — | — | Gold | 1-316131-5 | 1-316133-5 |
| | | | | | | | Gold | 2-316131-2 | 2-316133-2 |
| | | | | | | | Tin | — | 2-316133-3 |
| Tin | 2-316131-5 | — | | | | | | | |

Relative Product Information

Applicable contact...P.39

Performance & Specifications ...P.36

Accessories ...P.112

NOTE: all products are RoHS compliant On selection.

D-3200S Single-row High Voltage Type

Mated Dimension

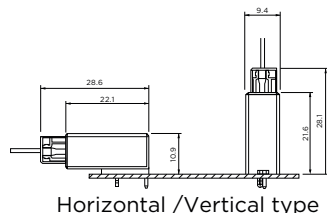
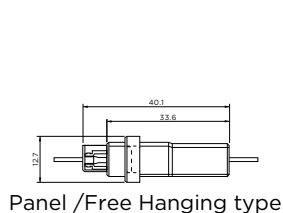

External Dimensions

■ Receptacle Housing

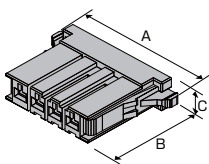

| Pos | Key | Color | Part Number | Dimensions | | |
|-----|-----|-------|-------------|------------|------|-----|
| | | | | A | B | C |
| 2 | X | Black | 1-178128-2 | 24.6 | 22.8 | 7.2 |
| | Y | Black | 2-178128-2 | | | |
| 3 | X | Black | 1-178128-3 | 29.7 | 22.8 | 7.2 |
| | Y | Black | 2-178128-3 | | | |
| | Z | Black | 3-178128-3 | | | |
| 4 | X | Black | 1-178128-4 | 34.8 | 22.8 | 7.2 |
| | Y | Black | 2-178128-4 | | | |
| 5 | X | Black | 1-178128-5 | 39.9 | 22.8 | 7.2 |
| | Y | Black | 2-178128-5 | | | |
| 6 | X | Black | 1-178128-6 | 45.0 | 22.8 | 7.2 |
| | Y | Black | 2-178128-6 | | | |

■ Tab Housing

Panel type

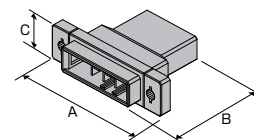

| Pos | Key | Color | Part Number | Dimensions | | |
|-----|-----|-------|-------------|------------|------|------|
| | | | | A | B | C |
| 2 | X | Black | 1-179553-2 | 36.8 | 33.6 | 12.7 |
| | Y | Black | 2-179553-2 | | | |
| 3 | X | Black | 1-179553-3 | 41.9 | 33.6 | 12.7 |
| | Y | Black | 2-179553-3 | | | |
| 4 | X | Black | 1-179553-4 | 47.0 | 33.6 | 12.7 |
| | Y | Black | 2-179553-4 | | | |

Free Hanging type

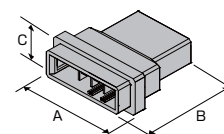

| Pos | Key | Color | Part Number | Dimensions | | |
|-----|-----|-------|-------------|------------|------|------|
| | | | | A | B | C |
| 2 | X | Black | 1-179552-2 | 23.0 | 33.6 | 12.7 |
| | Y | Black | 2-179552-2 | | | |
| 3 | X | Black | 1-179552-3 | 28.1 | 33.6 | 12.7 |
| | Y | Black | 2-179552-3 | | | |
| 4 | X | Black | 1-179552-4 | 33.2 | 33.6 | 12.7 |
| | Y | Black | 2-179552-4 | | | |

NOTE: all products are RoHS compliant On selection.

D-3200S Single-row High Voltage Type

Board-Mounting Header

Horizontal type

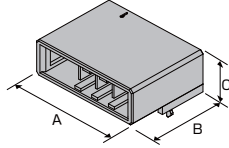

| Pos | Key | Plating | Color | Part Number | Dimensions | | |
|-----|-----|---------|-------|-------------|------------|------|------|
| | | | | | A | B | C |
| 2 | X | Gold | Black | 1-179276-2 | 19.1 | 22.1 | 10.9 |
| | | Gold | Black | 1-179276-3 | | | |
| | | Tin | Black | 1-179276-5 | | | |
| | Y | Gold | Black | 2-179276-2 | | | |
| | | Gold | Black | 2-179276-3 | | | |
| 3 | X | Gold | Black | 1-178138-2 | 24.2 | 22.1 | 10.9 |
| | | Gold | Black | 1-178138-3 | | | |
| | | Tin | Black | 1-178138-5 | | | |
| | Y | Gold | Black | 2-178138-2 | | | |
| | | Gold | Black | 2-178138-3 | | | |
| | | Tin | Black | 2-178138-5 | | | |
| 4 | X | Gold | Black | 1-179277-2 | 29.2 | 22.1 | 10.9 |
| | | Gold | Black | 1-179277-3 | | | |
| | | Tin | Black | 1-179277-5 | | | |
| | Y | Gold | Black | 2-179277-2 | | | |
| | | Gold | Black | 2-179277-3 | | | |
| 5 | X | Gold | Black | 1-316130-2 | 34.3 | 22.1 | 10.9 |
| | | Gold | Black | 1-316130-3 | | | |
| | | Tin | Black | 1-316130-5 | | | |
| | Y | Gold | Black | 2-316130-2 | | | |
| | | Gold | Black | 2-316130-3 | | | |
| | | Gold | Black | 2-316130-3 | | | |
| 6 | X | Gold | Black | 1-316131-2 | 39.4 | 22.1 | 10.9 |
| | | Gold | Black | 1-316131-3 | | | |
| | | Tin | Black | 1-316131-5 | | | |
| | Y | Gold | Black | 2-316131-2 | | | |
| | | Gold | Black | 2-316131-2 | | | |
| | | Tin | Black | 2-316131-5 | | | |

Board-Mounting Header

Vertical type

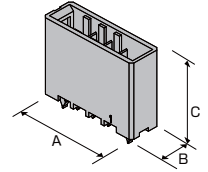

| Pos | Key | Plating | Color | Part Number | Dimensions | | |
|-----|-----|---------|-------|-------------|------------|-----|------|
| | | | | | A | B | C |
| 2 | X | Gold | Black | 1-917337-2 | 19.1 | 9.4 | 21.6 |
| | | Gold | Black | 1-917337-3 | | | |
| | | Tin | Black | 1-917337-5 | | | |
| | Y | Gold | Black | 2-917337-2 | | | |
| | | Gold | Black | 2-917337-3 | | | |
| 3 | X | Gold | Black | 1-178136-2 | 24.2 | 9.4 | 21.6 |
| | | Gold | Black | 1-178136-3 | | | |
| | | Tin | Black | 1-178136-5 | | | |
| | Y | Gold | Black | 2-178136-2 | | | |
| | | Gold | Black | 2-178136-3 | | | |
| | | Tin | Black | 2-178136-5 | | | |
| 4 | X | Gold | Black | 1-917338-2 | 29.2 | 9.4 | 21.6 |
| | | Gold | Black | 1-917338-3 | | | |
| | | Tin | Black | 1-917338-5 | | | |
| | Y | Gold | Black | 2-917338-2 | | | |
| | | Gold | Black | 2-917338-3 | | | |
| 5 | X | Gold | Black | 1-316132-2 | 34.3 | 9.4 | 21.6 |
| | | Gold | Black | 1-316132-3 | | | |
| | | Tin | Black | 1-316132-5 | | | |
| | Y | Gold | Black | 2-316132-2 | | | |
| | | Gold | Black | 2-316132-3 | | | |
| | | Gold | Black | 2-316132-3 | | | |
| 6 | X | Gold | Black | 1-316133-2 | 39.4 | 9.4 | 21.6 |
| | | Gold | Black | 1-316133-3 | | | |
| | | Tin | Black | 1-316133-5 | | | |
| | Y | Gold | Black | 2-316133-2 | | | |
| | | Gold | Black | 2-316133-2 | | | |
| | | Gold | Black | 2-316133-3 | | | |

NOTE: all products are RoHS compliant On selection.

D-3200M Double-row High Voltage Types

Type Chart

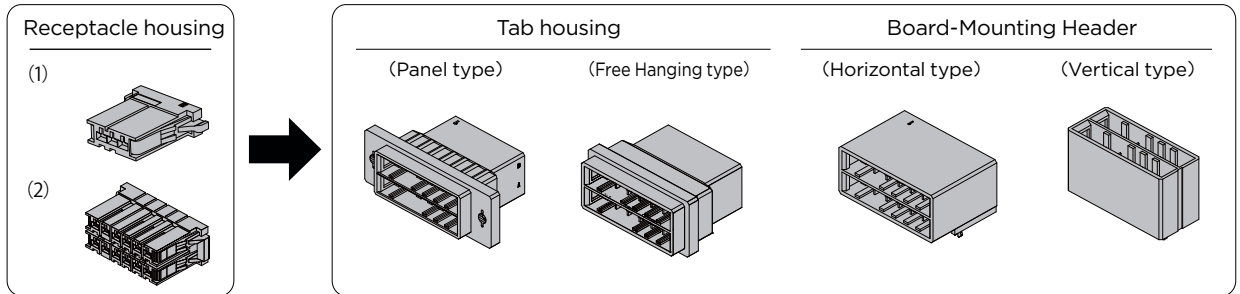

| Pos | Color | Key | Receptacle housing (2) | Tab housing | | | Plating | Board-Mounting Header | |
|-----|-------|------------|------------------------|-------------|-------------------|-----------|------------|-----------------------|---------------|
| | | | | Panel type | Free Hanging type | L Bracket | | Horizontal type | Vertical type |
| 6 | - | XX | 1-178129-6 | 1-179555-3 | 1-179554-3 | S | Gold | 1-178139-2 | 1-178140-2 |
| | | | | | | S | Gold | 1-178139-3 | 1-178140-3 |
| | | | | | | S | Tin | 1-178139-5 | 1-178140-5 |
| | - | YY | 2-178129-6 | 2-179555-3 | 2-179554-3 | S | Gold | 2-178139-2 | 2-178140-2 |
| | | | | | | S | Gold | 2-178139-3 | 2-178140-3 |
| | | | | | | S | Tin | 2-178139-5 | 2-178140-5 |
| - | XY | 3-178129-6 | 3-179555-3 | 3-179554-3 | S | Gold | 3-178139-2 | 3-178140-2 | |
| | | | | | S | Gold | 3-178139-3 | 3-178140-3 | |
| | | | | | S | Tin | 3-178139-5 | 3-178140-5 | |
| | | | ※(1) | — | — | — | Gold | 4-178139-2 | — |
| | | | ※(1) | — | — | — | Tin | 6-178139-5 | — |
| 10 | - | XX | 1-917659-5 | — | — | — | Gold | 1-316080-2 | 1-917657-2 |
| | | | | | | | Gold | 1-316080-3 | 1-917657-3 |
| | | | | | | | Tin | 1-316080-5 | 1-917657-5 |
| | - | YY | 2-917659-5 | — | — | — | Gold | 2-316080-2 | 2-917657-2 |
| | | | | | | | Gold | 2-316080-3 | 2-917657-3 |
| | | | | | | | Tin | 2-316080-5 | 2-917657-5 |
| | | | | | | | Gold | 3-316080-2 | 3-917657-2 |
| | | | | | | | Gold | 3-316080-3 | 3-917657-3 |
| | | | | | | | Tin | 3-316080-5 | 3-917657-5 |
| 12 | - | XX | 1-917659-6 | 1-179555-6 | 1-179554-6 | L | Gold | 1-316081-2 | 1-917658-2 |
| | | | | | | | Gold | 1-316081-3 | 1-917658-3 |
| | | | | | | | Tin | 1-316081-5 | 1-917658-5 |
| | - | YY | 2-917659-6 | 2-179555-6 | — | L | Gold | 2-316081-2 | 2-917658-2 |
| | | | | | | | Gold | 2-316081-3 | 2-917658-3 |
| | | | | | | | Tin | — | — |
| | | | | | | | Gold | 3-316081-2 | 3-917658-2 |
| | | | | | | | Gold | 3-316081-3 | 3-917658-3 |
| | | | | | | | Tin | — | — |
| 20 | - | XX | 1-917659-8 | 1-179555-8 | — | — | — | — | — |

Relative Product Information

Applicable contact...P. 39
 Performance & Specifications...P. 36
 Accessories...P. 112

For(1)D-3200S Receptacle housing, please see P.47
 PN 1-178128-3 and 3-178128-3 are used.

NOTE: all products are RoHS compliant On selection.

D-3200M Double-row High-voltage Modular Types

Mated Dimension

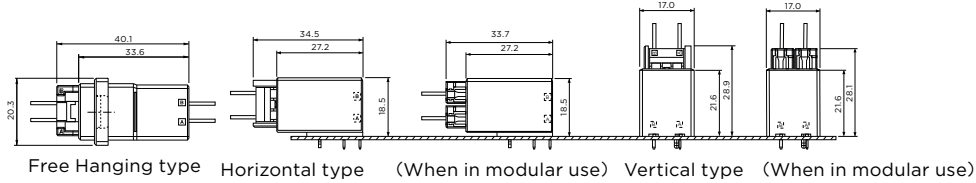

External Dimensions

■ Receptacle Housing

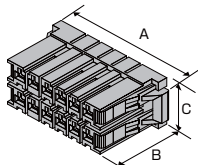

| Pos | Key | Color | Part Number | Dimensions | | |
|-----|-----|-------|-------------|------------|------|------|
| | | | | A | B | C |
| 6 | XX | Black | 1-178129-6 | 27.3 | 22.8 | 14.8 |
| | YY | Black | 2-178129-6 | | | |
| | XY | Black | 3-178129-6 | | | |
| 10 | XX | Black | 1-917659-5 | 37.5 | 22.8 | 14.8 |
| | YY | Black | 2-917659-5 | | | |
| | XY | Black | 3-917659-5 | | | |
| 12 | XX | Black | 1-917659-6 | 42.5 | 22.8 | 14.8 |
| | YY | Black | 2-917659-6 | | | |
| | XY | Black | 3-917659-6 | | | |
| 20 | XX | Black | 1-917659-8 | 62.9 | 22.8 | 14.8 |

■ Tab Housing

Panel type

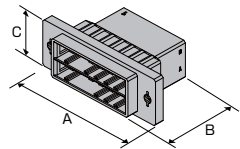

| Pos | Key | Color | Part Number | Dimensions | | |
|-----|-----|-------|-------------|------------|------|------|
| | | | | A | B | C |
| 6 | XX | Black | 1-179555-3 | 41.9 | 33.6 | 20.3 |
| | YY | Black | 2-179555-3 | | | |
| | XY | Black | 3-179555-3 | | | |
| 12 | XX | Black | 1-179555-6 | 57.9 | 33.6 | 20.3 |
| | YY | Black | 2-179555-6 | | | |
| | XY | Black | 3-179555-6 | | | |
| 20 | XX | Black | 1-179555-8 | 78.2 | 33.6 | 20.3 |

Free Hanging type

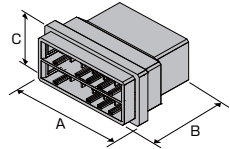

| Pos | Key | Color | Part Number | Dimensions | | |
|-----|-----|-------|-------------|------------|------|------|
| | | | | A | B | C |
| 6 | XX | Black | 1-179554-3 | 28.1 | 33.6 | 20.3 |
| | YY | Black | 2-179554-3 | | | |
| | XY | Black | 3-179554-3 | | | |
| 12 | XX | Black | 1-179554-6 | 43.4 | 33.6 | 20.3 |
| | XY | Black | 3-179554-6 | | | |

NOTE: all products are RoHS compliant On selection.

D-3200M Double-row High-voltage Modular Types

Board-Mounting Header

Horizontal type

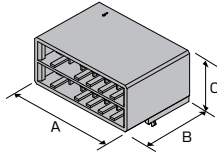

| Pos | Key | Plating | Color | Part Number | Dimensions | | |
|------|-----|---------|------------|-------------|------------|------|------|
| | | | | | A | B | C |
| 6 | XX | Gold | Black | 1-178139-2 | 24.2 | 27.2 | 18.5 |
| | | Gold | Black | 1-178139-3 | | | |
| | | Tin | Black | 1-178139-5 | | | |
| | YY | Gold | Black | 2-178139-2 | | | |
| | | Gold | Black | 2-178139-3 | | | |
| | | Tin | Black | 2-178139-5 | | | |
| | XY | Gold | Black | 3-178139-2 | | | |
| | | Gold | Black | 3-178139-3 | | | |
| | | Tin | Black | 3-178139-5 | | | |
| | YX | Gold | Black | 4-178139-2 | | | |
| ZX | Tin | Black | 6-178139-5 | | | | |
| 10 | XX | Gold | Black | 1-316080-2 | 34.3 | 27.2 | 18.5 |
| | | Gold | Black | 1-316080-3 | | | |
| | | Tin | Black | 1-316080-5 | | | |
| | YY | Gold | Black | 2-316080-2 | | | |
| | | Gold | Black | 2-316080-3 | | | |
| | | Tin | Black | 2-316080-5 | | | |
| | XY | Gold | Black | 3-316080-2 | | | |
| | | Gold | Black | 3-316080-3 | | | |
| | | Tin | Black | 3-316080-5 | | | |
| | 12 | XX | Gold | Black | | | |
| Gold | | | Black | 1-316081-3 | | | |
| Tin | | | Black | 1-316081-5 | | | |
| YY | | Gold | Black | 2-316081-2 | | | |
| | | Gold | Black | 2-316081-3 | | | |
| | | Tin | Black | — | | | |
| XY | | Gold | Black | 3-316081-2 | | | |
| | | Gold | Black | 3-316081-3 | | | |
| | | Gold | Black | 3-316081-3 | | | |

Board-Mounting Header

Vertical type

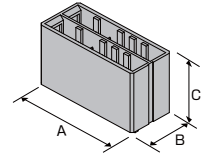

| Pos | Key | Plating | Color | Part Number | Dimensions | | |
|------|------|---------|-------|-------------|------------|------|------|
| | | | | | A | B | C |
| 6 | XX | Gold | Black | 1-178140-2 | 24.2 | 17.0 | 21.6 |
| | | Gold | Black | 1-178140-3 | | | |
| | | Tin | Black | 1-178140-5 | | | |
| | YY | Gold | Black | 2-178140-2 | | | |
| | | Gold | Black | 2-178140-3 | | | |
| | | Tin | Black | 2-178140-5 | | | |
| | XY | Gold | Black | 3-178140-2 | | | |
| | | Gold | Black | 3-178140-3 | | | |
| | | Tin | Black | 3-178140-5 | | | |
| | 10 | XX | Gold | Black | | | |
| Gold | | | Black | 1-917657-3 | | | |
| Tin | | | Black | 1-917657-5 | | | |
| YY | | Gold | Black | 2-917657-2 | | | |
| | | Gold | Black | 2-917657-3 | | | |
| | | Tin | Black | 2-917657-5 | | | |
| XY | | Gold | Black | 3-917657-2 | | | |
| | | Gold | Black | 3-917657-3 | | | |
| | | Tin | Black | 3-917657-5 | | | |
| 12 | | XX | Gold | Black | 1-917658-2 | 39.4 | 17.0 |
| | Gold | | Black | 1-917658-3 | | | |
| | Tin | | Black | 1-917658-5 | | | |
| | YY | Gold | Black | 2-917658-2 | | | |
| | | Gold | Black | 2-917658-3 | | | |
| | | Tin | Black | — | | | |
| | XY | Gold | Black | 3-917658-2 | | | |
| | | Gold | Black | 3-917658-3 | | | |
| | | Tin | Black | — | | | |

NOTE: all products are RoHS compliant On selection.

D-3200M Double-row High-voltage Modular Types

Type Chart

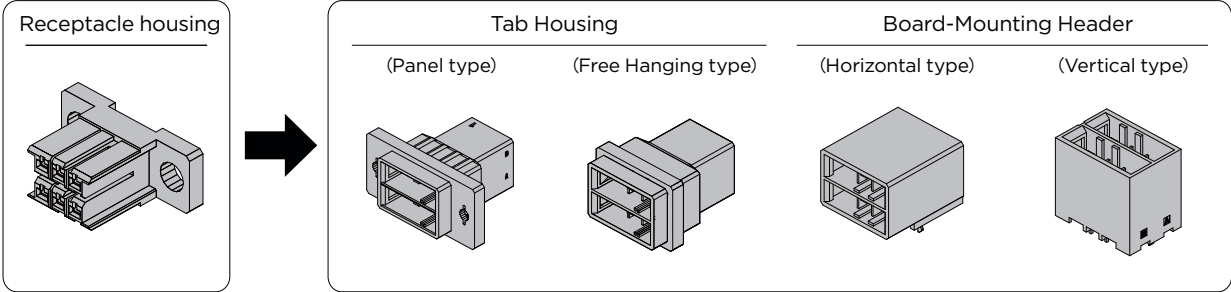

| Pos | Color | Key | Receptacle housing | Tab housing | | Plating | Board-Mounting Header | |
|-----|-------|-----|--------------------|-------------|-------------------|---------|-----------------------|---------------|
| | | | | Panel type | Free Hanging type | | Horizontal type | Vertical type |
| 6 | Black | XX | 1-917266-3 | 1-179555-3 | 1-179554-3 | Gold | 1-178139-2 | 1-178140-2 |
| | | | | | | Gold | 1-178139-3 | 1-178140-3 |
| | | | | | | Tin | 1-178139-5 | 1-178140-5 |

Relative Product Information

- Applicable contact...P.39
- Performance & Specifications ...P.36
- Accessories ...P.112

Applications

Example of Compact Disk Device Application

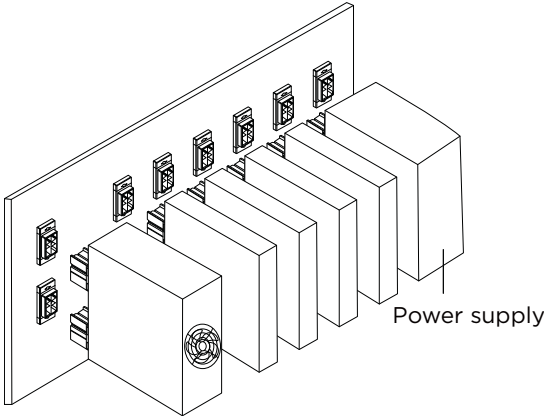

NOTE: all products are RoHS compliant On selection.

D-3200M Double-row High voltage Drawer Types

Mated Dimension

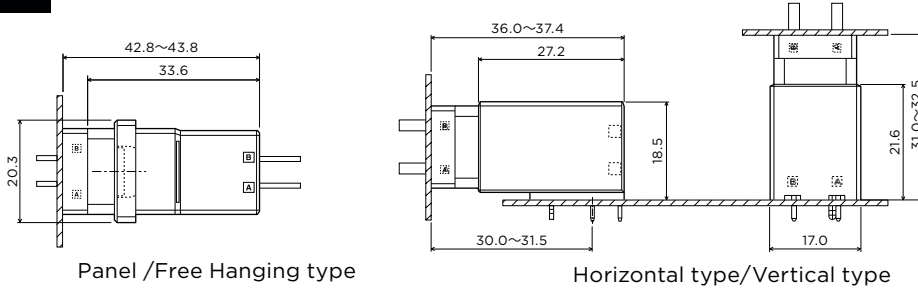

External Dimensions

Receptacle Housing (Drawer type)

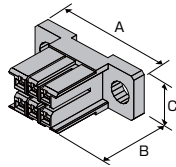

| Pos | Key | Color | Part Number | Dimensions | | |
|-----|-----|-------|-------------|------------|------|------|
| | | | | A | B | C |
| 6 | XX | Black | 1-917266-3 | 40.0 | 25.7 | 15.4 |

Tab Housing

Panel type

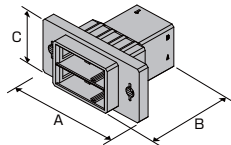

| Pos | Key | Color | Part Number | Dimensions | | |
|-----|-----|-------|-------------|------------|------|------|
| | | | | A | B | C |
| 6 | XX | Black | 1-179555-3 | 41.9 | 33.6 | 20.3 |

Free Hanging type

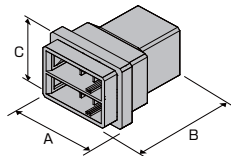

| Pos | Key | Color | Part Number | Dimensions | | |
|-----|-----|-------|-------------|------------|------|------|
| | | | | A | B | C |
| 6 | XX | Black | 1-179554-3 | 28.1 | 33.6 | 20.3 |

NOTE: all products are RoHS compliant On selection.

Board-Mounting Header

Horizontal type

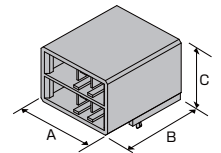

| Pos | Key | Plating | Color | Part Number | Dimensions | | |
|-----|-----|---------|-------|-------------|------------|------|------|
| | | | | | A | B | C |
| 6 | XX | Gold | Black | 1-178139-2 | 24.2 | 27.2 | 18.5 |
| | | Gold | Black | 1-178139-3 | | | |
| | | Tin | Black | 1-178139-5 | | | |

Vertical type

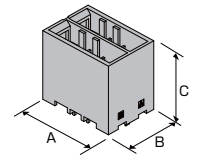

| Pos | Key | Plating | Color | Part Number | Dimensions | | |
|-----|-----|---------|-------|-------------|------------|------|------|
| | | | | | A | B | C |
| 6 | XX | Gold | Black | 1-178140-2 | 24.2 | 17.0 | 21.6 |
| | | Gold | Black | 1-178140-3 | | | |
| | | Tin | Black | 1-178140-5 | | | |

D-3200 FMLB (Sequential Type)

Type Chart

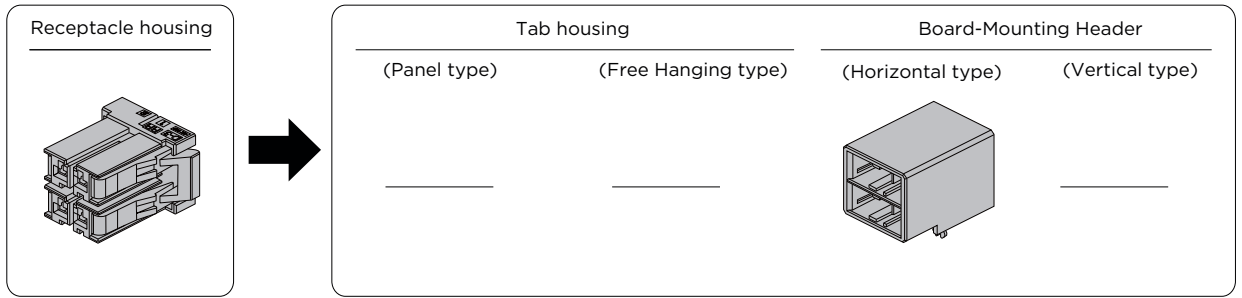

| Pos | Color | Key | Receptacle housing | Tab housing | | Plating | Board-Mounting Header | |
|-----|-------|-----|--------------------|-------------|-------------------|---------|-----------------------|---------------|
| | | | | Panel type | Free Hanging type | | Horizontal type | Vertical type |
| 4 | Black | RR | 1-2291727-1 | — | — | Gold | 1-2299004-1 | — |
| | | SS | 2-2291727-1 | — | — | | 2-2299004-1 | — |
| 12 | Black | RR | 1-2291728-1 | — | — | Gold | 1-2299005-1 | — |
| | | SS | 2-2291728-1 | — | — | | 2-2299005-1 | — |
| | | RS | — | — | — | | 3-2299005-1 | — |

Mated Dimension

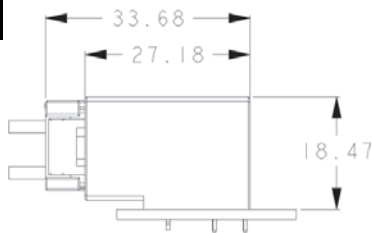

External Dimensions

Receptacle Housing

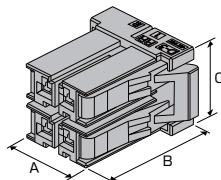

| Pos | Key | Color | Part Number | Dimensions | | |
|-----|-----|-------|-------------|------------|------|------|
| | | | | A | B | C |
| 4 | RR | Black | 1-2291727-1 | 14.2 | 22.8 | 14.8 |
| | SS | | 2-2291727-1 | | | |
| 12 | RR | Black | 1-2291728-1 | 34.5 | 22.8 | 14.8 |
| | SS | | 2-2291728-1 | | | |

Board-Mounting Header

Horizontal type

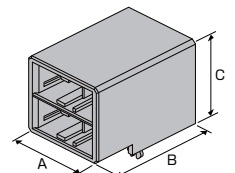

| Pos | Key | Plating | Color | Part Number | Dimensions | | |
|-----|-----|---------|-------|-------------|------------|------|------|
| | | | | | A | B | C |
| 4 | RR | — | Black | 1-2299004-1 | 14.2 | 22.8 | 14.8 |
| | SS | — | | 2-2299004-1 | | | |
| 12 | RR | — | Black | 1-2299005-1 | 34.5 | 22.8 | 14.8 |
| | SS | — | | 2-2299005-1 | | | |
| | RS | — | | 3-2299005-1 | | | |

Relative Product Information

Applicable contact...P.39

Performance & Specifications ...P.36

Accessories ...P.112

NOTE: all products are RoHS compliant On selection.

Stress relief (optional)

| Pos | Key | Plating | Part Number |
|-----|-----|---------|-------------|
| 4 | RR | Black | 1-2303376-1 |
| | SS | | 2-2303376-1 |
| 12 | RR | Black | 1-2303378-1 |
| | SS | | 2-2303378-1 |
| | RS | | 3-2303378-1 |

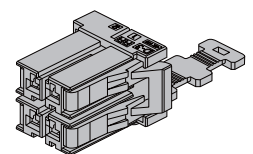

D-3200T Triple-row High Voltage Modular Types

Type Chart

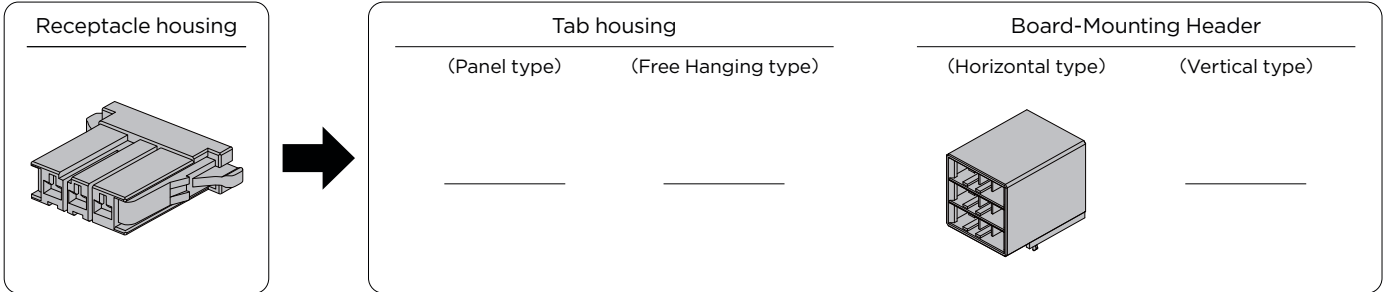

| Receptacle Housing (maximum 9 Pos.) | | | | | |
|-------------------------------------|-----|-------------|---|-----|-------------|
| Single-Row (D-3200S) ※1 | | | Double-Row (D-3200M)+Single-Row (D-3100S) | | |
| POS | KEY | Part Number | POS | KEY | Part Number |
| 3 | X | 1-178128-3 | 6 | XX | 1-178129-6 |
| 3 | X | 1-178128-3 | | | |
| 3 | X | 1-178128-3 | 3 | X | 1-178129-3 |
| 3 | X | 1-178128-3 | 3 | Y | 2-178129-3 |
| 3 | X | 1-178128-3 | 6 | XX | 1-178129-6 |
| 3 | Y | 2-178128-3 | | | |
| 3 | Y | 2-178128-3 | 3 | X | 1-178129-3 |
| 3 | Y | 2-178128-3 | 6 | YY | 2-178129-6 |
| 3 | X | 1-178128-3 | | | |
| 3 | X | 1-178128-3 | 3 | X | 1-178129-3 |
| 3 | Y | 2-178128-3 | 6 | XY | 3-178129-6 |
| 3 | X | 1-178128-3 | | | |
| 3 | Z | 3-178128-3 | 3 | Z | 3-178129-3 |
| 3 | Y | 2-178128-3 | 6 | XY | 3-178129-6 |
| 3 | X | 1-178128-3 | | | |

| Board-Mounting Header | | | |
|---------------------------|-----|---------|-------------|
| Horizontal type (D-3200T) | | | |
| POS | KEY | Plating | Part Number |
| 9 | XXX | Au | 1-1123624-2 |
| | | Sn | 1-1123624-5 |
| 9 | XXY | Au | 3-1123624-2 |
| | | Sn | 3-1123624-5 |
| 9 | YYX | Au | 4-1123624-2 |
| | | Sn | 4-1123624-5 |
| 9 | YYX | Au | 5-1123624-2 |
| | | Sn | 5-1123624-5 |
| 9 | XYZ | Au | 9-1123624-2 |

※1 refer to P.47

Relative Product Information

Applicable contact...P.39
Performance & Specifications ...P.36

Mated Dimension

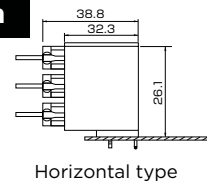

External Dimensions

Receptacle Housing

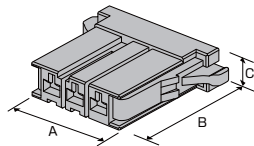

| Pos | Key | Color | Part Number | Dimensions | | |
|-----|-----|-------|-------------|------------|------|------|
| | | | | A | B | C |
| 3 | X | Black | 1-178128-3 | 29.7 | 22.8 | 7.2 |
| | Y | Black | 2-178128-3 | | | |
| | Z | Black | 3-178128-3 | | | |
| 6 | XX | Black | 1-178129-6 | 27.3 | 22.8 | 14.8 |
| | YY | Black | 2-178129-6 | | | |
| | XY | Black | 3-178129-6 | | | |

Board-Mounting Header

Horizontal type

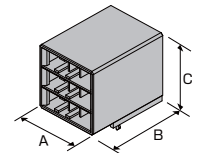

| Pos | Key | Plating | Color | Part Number | Dimensions | | |
|-----|-----|---------|-------|-------------|------------|------|------|
| | | | | | A | B | C |
| 9 | XXX | Gold | Black | 1-1123624-2 | 24.2 | 32.3 | 27.1 |
| | | Tin | Black | 1-1123624-5 | | | |
| | XXY | Tin | Black | 3-1123624-5 | | | |
| | YYX | Tin | Black | 4-1123624-5 | | | |
| | YYX | Gold | Black | 5-1123624-2 | | | |
| | XYZ | Gold | Black | 9-1123624-2 | | | |

NOTE: all products are RoHS compliant On selection.

D-3400F Skyscraper Connectors

Type Chart

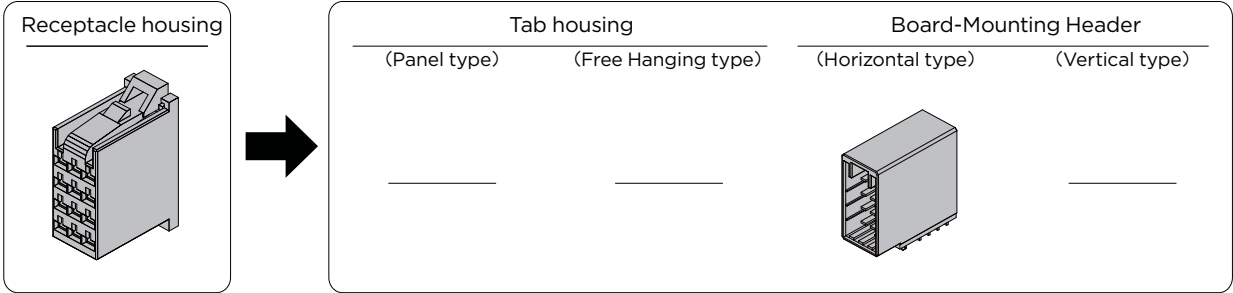

| Pos | Color | Key | Receptacle housing | Tab housing | | Plating | Board-Mounting Header | |
|-----|-------|-----|--------------------|-------------|-------------------|---------|-----------------------|---------------|
| | | | | Panel type | Free Hanging type | | Horizontal type | Vertical type |
| 12 | Black | — | 178214-1 | — | — | Gold | 178216-2 | — |
| | | | | — | — | Gold | 178216-3 | — |
| | | | | — | — | Tin | 178216-5 | — |
| 20 | Black | — | 917249-1 | — | — | Gold | 917251-2 | — |
| | | | | — | — | Gold | 917251-3 | — |
| | | | | — | — | Tin | 917251-5 | — |

Mated Dimension

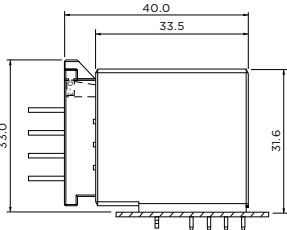

External Dimensions

Receptacle Housing

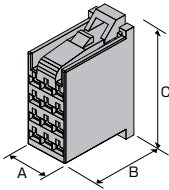

| Pos | Key | Color | Part Number | Dimensions | | |
|-----|-----|-------|-------------|------------|------|------|
| | | | | A | B | C |
| 12 | — | Black | 178214-1 | 12.2 | 22.8 | 32.1 |
| 20 | — | Black | 917249-1 | 19.8 | 22.8 | 32.1 |

Board-Mounting Header

Horizontal type

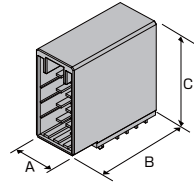

| Pos | Key | Plating | Color | Part Number | Dimensions | | |
|-----|-----|---------|-------|-------------|------------|------|------|
| | | | | | A | B | C |
| 12 | — | Gold | Black | 178216-2 | 15.0 | 33.5 | 31.6 |
| | — | Gold | Black | 178216-3 | | | |
| | — | Tin | Black | 178216-5 | | | |
| 20 | — | Gold | Black | 917251-2 | 22.6 | 33.5 | 31.6 |
| | — | Gold | Black | 917251-3 | | | |
| | — | Tin | Black | 917251-5 | | | |

NOTE: all products are RoHS compliant On selection.

D-3500D Sensor Connector

Type Chart

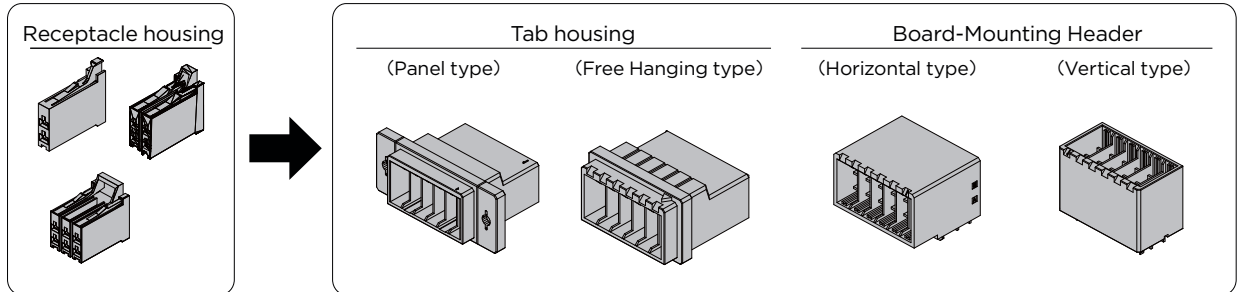

| Pos | Color | Key | Receptacle housing | Tab housing | | | Plating | Board-Mounting Header | |
|-----|-------|-----|--------------------|------------------------|------------------------|-----------|---------|-----------------------|---------------|
| | | | | Panel type | Free Hanging type | L Bracket | | Horizontal type | Vertical type |
| 2 | Black | — | 175362-1 | — | — | — | — | — | — |
| | | | 175362-2 | — | — | — | — | — | — |
| | | | 175362-3 | — | — | — | — | — | — |
| 4 | Black | — | 175363-1 | — | — | — | Gold | 1376133-2 | — |
| | White | | 1-175363-1 | | | | | | |
| | Black | | 175363-2* | | | | | | |
| | Black | | 2-175363-1 | | | | | | |
| 6 | Black | — | 1318095-1 | — | — | — | — | — | — |
| | | | 1318095-2 | | | | | | |
| 12 | Black | — | — | 917241-6 3-917241-6 | 917242-6 3-917242-6 | S | Gold | 177555-2 | 316516-2 |
| | | | | | | | Gold | 177555-3 | 316516-3 |
| | | | | | | | Gold | 1-177555-2 | — |
| | | | | | | | Tin | 177555-5 | 316516-5 |
| 20 | Black | — | — | 917241-8 3-917241-8 | 917242-8 3-917242-8 | S | Gold | 175365-2 | 316517-2 |
| | | | | | | | Gold | 175365-3 | 316517-3 |
| | | | | | | | Tin | 175365-5 | 316517-5 |

* Small Lever Type

Mated Dimension

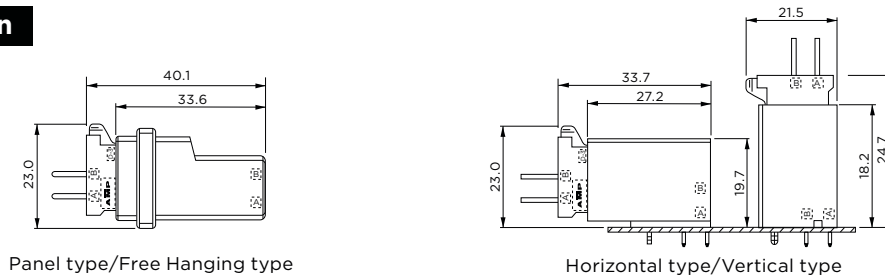

Relative Product Information

- Applicable contact...P.39
- Performance & Specifications ...P.36
- Accessories ...P.112

NOTE: all products are RoHS compliant On selection.

D-3500D Sensor Connector

External Dimensions

■ Receptacle Housing

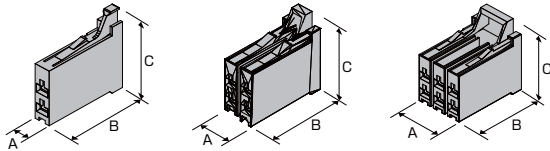

| Pos | Key | Color | Part Number | Dimensions | | |
|-----|-----|-------|-------------|------------|------|------|
| | | | | A | B | C |
| 2 | — | Black | 175362-1 | 4.6 | 22.8 | 21.0 |
| | — | Black | 175362-2 | | | |
| | — | Black | 175362-3 | | | |
| 4 | — | Black | 175363-1 | 9.7 | 22.8 | 21.0 |
| | — | White | 1-175363-1 | | | |
| | — | Blue | 2-175363-1 | | | |
| | — | Black | 175363-2 | | | |
| 6 | — | Black | 1318095-1 | 14.7 | 22.8 | 21.0 |
| | — | Black | 1318095-2 | | | |

■ Tab Housing

Panel type

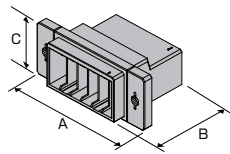

| Pos | Key | Color | Part Number | Dimensions | | |
|-----|-----|-------|-------------|------------|------|------|
| | | | | A | B | C |
| 12 | — | Black | 917241-6 | 52.0 | 33.6 | 21.5 |
| | — | Black | 3-917241-6 | | | |
| 20 | — | Black | 917241-8 | 72.0 | 33.6 | 21.5 |
| | — | Black | 3-917241-8 | | | |

Free Hanging type

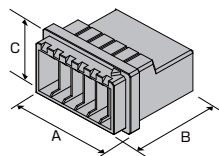

| Pos | Key | Color | Part Number | Dimensions | | |
|-----|-----|-------|-------------|------------|------|------|
| | | | | A | B | C |
| 12 | — | Black | 917242-6 | 36.4 | 33.6 | 21.5 |
| | — | Black | 3-917242-6 | | | |
| 20 | — | Black | 917242-8 | 56.8 | 33.6 | 21.5 |
| | — | Black | 3-917242-8 | | | |

NOTE: all products are RoHS compliant On selection.

■ Board-Mounting Header

Horizontal type

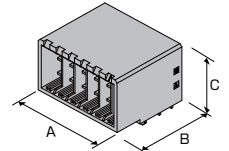

| Pos | Key | Plating | Color | Part Number | Dimensions | | |
|-----|-----|---------|-------|-------------|------------|------|------|
| | | | | | A | B | C |
| 4 | — | Gold | Black | 1376133-2 | 12.2 | 27.2 | 19.7 |
| 12 | — | Gold | Black | 177555-2 | 32.5 | 27.2 | 19.7 |
| | — | Gold | Black | 177555-3 | | | |
| | — | Tin | Black | 177555-5 | | | |
| 20 | — | Gold | Black | 1-177555-2 | 52.8 | 27.2 | 19.7 |
| | — | Gold | Black | 175365-2 | | | |
| | — | Gold | Black | 175365-3 | | | |
| | — | Tin | Black | 175365-5 | | | |

Vertical type

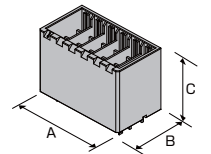

| Pos | Key | Plating | Color | Part Number | Dimensions | | |
|-----|-----|---------|-------|-------------|------------|------|------|
| | | | | | A | B | C |
| 12 | — | Gold | Black | 316516-2 | 32.5 | 18.2 | 21.6 |
| | — | Gold | Black | 316516-3 | | | |
| | — | Tin | Black | 316516-5 | | | |
| 20 | — | Gold | Black | 316517-2 | 52.8 | 18.2 | 21.6 |
| | — | Gold | Black | 316517-3 | | | |
| | — | Tin | Black | 316517-5 | | | |

Spring Clamp Type

The Spring Clamp Type series is a spring clamp type connector applicable to Servo I/O application, etc.

Thanks to the on-site mounting without any crimping tools, working time can be saved significantly.



- Adopt the standard wiring method as Dynamic series, and Spring clamp type contacts on receptacle side which comply with UL1059.

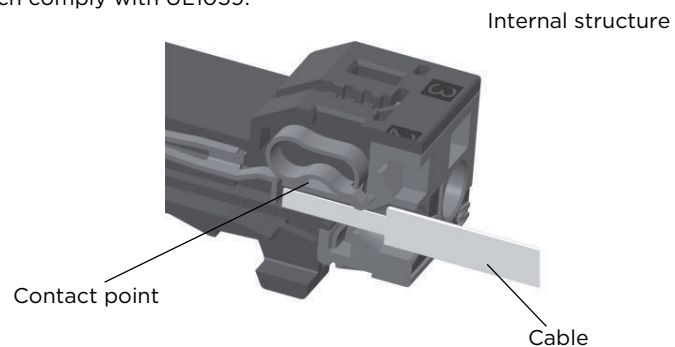

- Applicable to ports of power supply series where a UL508 servo amplifier and inverter, etc. must be used.
- The implementation can be carried out on-site without any crimping tools. Compared to the spiral wiring method, working time is saved significantly.

Product Features

1. Spring clamp contact

The contact is assembled in housing already with a spring clamp design which provide easy on-site installation, therefore increase the efficiency of assembly.

2. Audible Latching

Obvious lock sound and feeling when mating means work can be done without mistakes, such as mismatching (halfmating), even if the connection cannot be seen.

3. Keying

The housing is keyed (with a slit), so differentiating between X keys and Y keys prevents mismatching. It is also possible to make more key patterns by using keying plugs.

Spring Clamp Series Performance and Specifications

Performance

| Item \ Series | D-2950 | D-3950 | D-4950 |
|---------------------------------|-------------------|---------------------|-------------------|
| Contact pitch [mm] | 5.08 | 7.5 | 7.5 |
| Rated current max. UL [A] | 10 (AWG14 x 1) | 14.5 (AWG14 x 1) | 22 (AWG10 x 1) |
| Rated voltage UL1059 B [V] | 300 AC/DC | 300 AC/DC | 300 AC/DC |
| Rated voltage UL1059 C [V] | - | 300 AC/DC | 300 AC/DC |
| Rated voltage UL1059 D [V] | 300 AC/DC | 600 AC/DC | 600 AC/DC |
| Dielectric withstanding Voltage | 2,200V AC | 2,200V AC | 2,200V AC |
| Wire size [AWG] | 18-14 | 22-14 | 10-16 |
| Wire size [sq] | 0.75-2.0 | 0.3-2.0 | 1.25-5.5 |

Positions/ Wire size / Rated current

D-2950 series

| No of energized positions | Current(A) | | | | |
|---------------------------|------------|-------|-------|-------|-------|
| | AWG14 | AWG16 | AWG18 | AWG20 | AWG22 |
| 5 | 11.25 | 10.5 | 9.5 | 8 | 6.5 |
| 6 | 10.5 | 9.75 | 9 | 7 | 5.5 |

D-3950 series

| No of energized positions | Current(A) | | | | |
|---------------------------|------------|-------|-------|-------|-------|
| | AWG14 | AWG16 | AWG18 | AWG20 | AWG22 |
| 1 | 14.5 | 13.75 | 13 | 10.75 | 8.7 |
| 2-5 | 12.75 | 11.75 | 10.25 | 8.25 | 7.2 |
| 6-11 | 11.8 | 9.75 | 8.75 | 7 | 5.5 |

D-4950 series

| No of energized positions | Current(A) | | | | |
|---------------------------|------------|-------|-------|-------|--|
| | AWG10 | AWG12 | AWG14 | AWG16 | |
| 1 | 22 | 19 | 15 | 10 | |
| 2-5 | | | | | |
| 6-11 | | | | | |

Product Specifications

| Item \ Series | D-2950 | D-3950 | D-4950 |
|---------------------------|------------|-----------|------------|
| Product Specification | 108-140221 | 108-78997 | 108-140216 |
| Application Specification | 408-78172 | 411-78272 | 408-78173 |

Materials and Plating

| Description | Material | Finish |
|---|--------------|--|
| Receptacle contact (mating area only) | Copper alloy | Mating area: 0.38µm Gold plating over 1.27µm Nickel under plating |
| Board-mounting header contact | Copper alloy | Mating area: 0.38µm Gold plating over 1.27µm Nickel under plating Tail area: 2µm TIN plating over 1.27µm Nickel under plating |
| Receptacle Housing Board-mounting header Housing | | Thermoplastic PBT contain glass fiber, UL94V-0, |

D-2950 Spring Clamp Type

Type Chart

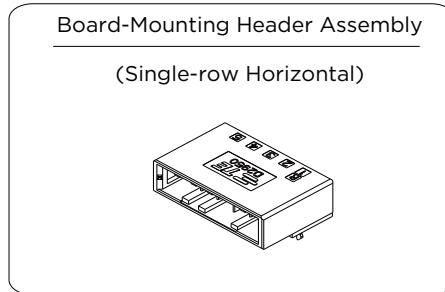
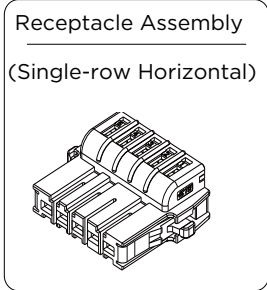

| Pos | Color | Key | Plating | Circuit mark | Receptacle Assembly | Board-Mounting Header Assembly |
|-----|-------|-----|---------|--------------|-----------------------|--------------------------------|
| | | | | | Single-row Horizontal | Single-row Horizontal |
| 5 | Black | X | Gold | Yes | 1-2347004-5 | 1-2347005-5 |
| 6 | Black | X | Gold | Yes | 1-2347004-6 | 1-2347005-6 |

Mated Dimension

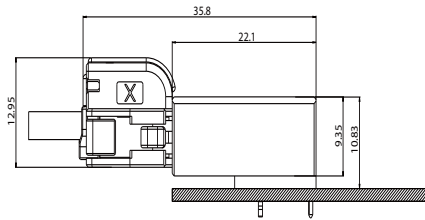

Opener: 2347681-1

External Dimensions

■ Receptacle Assembly Single-Row Horizontal

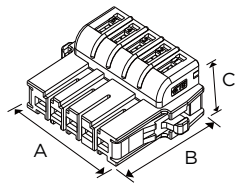

| Pos | Key | Plating | Color | Part Number | Dimensions | | |
|-----|-----|---------|-------|-------------|------------|------|------|
| | | | | | A | B | C |
| 5 | X | Gold | Black | 1-2347004-5 | 39.2 | 29.0 | 13.0 |
| 6 | X | Gold | Black | 1-2347004-6 | 44.3 | 29.0 | 13.0 |

■ Board-Mounting Header Assembly Single-Row Horizontal

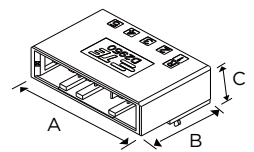

| Pos | Key | Plating | Color | Part Number | Dimensions | | |
|-----|-----|---------|-------|-------------|------------|------|------|
| | | | | | A | B | C |
| 5 | X | Gold | Black | 1-2347005-5 | 34.3 | 22.1 | 10.9 |
| 6 | X | Gold | Black | 1-2347005-6 | 39.4 | 22.1 | 10.9 |

NOTE: all products are RoHS compliant On selection.

D-3950 Spring Clamp Type

Type Chart

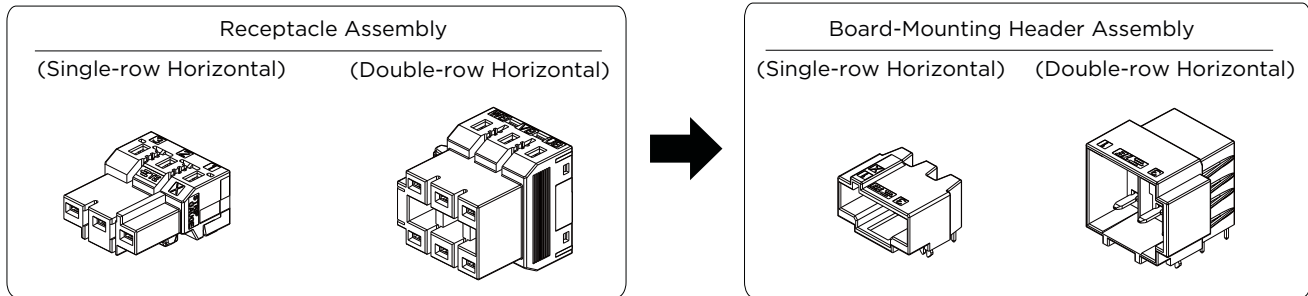

| Pos | Color | Key | Plating | Circuit mark | Receptacle Assembly | | Board-Mounting Header Assembly | |
|-----|-------|-----|---------|--------------|-----------------------|-----------------------|--------------------------------|-----------------------|
| | | | | | Single-row Horizontal | Double-row Horizontal | Single-row Horizontal | Double-row Horizontal |
| 3 | Black | X | Gold | Yes | 3-2229794-1 | — | 3-2229803-1 | — |
| | | | | No | 3-2289080-1 | — | | — |
| 4 | Black | X | Gold | Yes | 1-2331743-4 | — | 1-2271457-4 | — |
| | | | | No | 1-2331743-1 | — | | — |
| | | | | Y | 2-2331743-1 | — | | 2-2271457-4 |
| 6 | Black | X | Gold | No | 1-2271454-6 | — | 1-2271457-6 | — |
| 6 | Black | — | Gold | Yes | — | 2229800-1 | — | 2229806-1 |
| ※7 | Black | Y | Gold | Yes | 1-2229794-2 | — | 1-2229803-2 | — |
| 8 | Black | X | Gold | Yes | 1-2349815-2 | — | 1-2271457-8 | — |
| 11 | Black | X | Gold | Yes | 1-2229794-1 | — | 1-2229803-1 | — |
| | | | | No | 1-2289080-1 | — | | — |

※ The 7P connector is a 11P connector with 4 contacts removed.

Mated Dimension

Double row

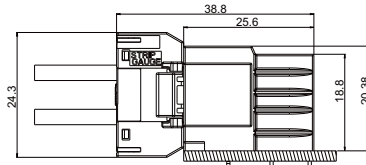

Single row

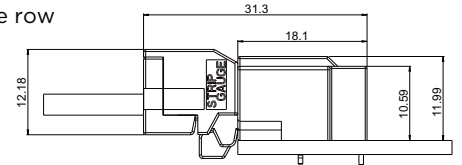

Opener: 1981045-1

External Dimensions

■ Receptacle assembly

Single-Row Horizontal

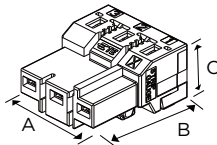

| Pos | Key | Plating | Circuit Illustration | Color | Part Number | Dimensions | | |
|-----|-----|---------|----------------------|-------|-------------|------------|-------------|------|
| | | | | | | A | B | C |
| 3 | X | Gold | Yes | Black | 3-2229794-1 | 22.0 | 25.4 | 15.6 |
| | | | | | 3-2289080-1 | 22.0 | 25.4 | 15.6 |
| 4 | X | Gold | Yes | Black | 1-2331743-4 | 27.7 | 25.4 | 15.6 |
| | | | No | Black | 1-2331743-1 | 27.7 | 25.4 | 15.6 |
| | | | Y | Gold | No | Black | 2-2331743-1 | 27.7 |
| 6 | X | Gold | No | Black | 1-2271454-6 | 44.5 | 25.4 | 15.6 |
| ※7 | Y | Gold | Yes | Black | 1-2229794-2 | 82.0 | 25.4 | 15.6 |
| 8 | X | Gold | Yes | Black | 1-2349815-2 | 57.7 | 25.4 | 15.6 |
| 11 | X | Gold | Yes | Black | 1-2229794-1 | 82.0 | 25.4 | 15.6 |
| | | | No | Black | 1-2289080-1 | 82.0 | 25.4 | 15.6 |

※ The 7P connector is a 11P connector with 4 contacts removed.

Double-row Horizontal

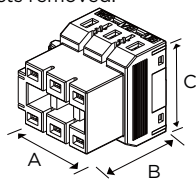

| Pos | Key | Plating | Color | Part Number | Dimensions | | |
|-----|-----|---------|-------|-------------|------------|------|------|
| | | | | | A | B | C |
| 6 | — | Gold | Black | 2229800-1 | 25.2 | 25.6 | 20.4 |

NOTE: all products are RoHS compliant On selection.

■ Board-Mounting Header Assembly

Single-Row Horizontal

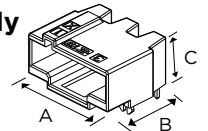

| Pos | Key | Plating | Color | Part Number | Dimensions | | |
|-----|-----|---------|-------|-------------|-------------|------|------|
| | | | | | A | B | C |
| 3 | X | Gold | Black | 3-2229803-1 | 22.0 | 18.1 | 12.0 |
| 4 | X | Gold | Black | 1-2271457-4 | 29.5 | 18.1 | 12.0 |
| | | Y | Gold | Black | 2-2271457-4 | 29.5 | 18.1 |
| 6 | X | Gold | Black | 1-2271457-6 | 44.5 | 18.1 | 12.0 |
| ※7 | Y | Gold | Black | 1-2229803-2 | 82.0 | 18.1 | 12.0 |
| 8 | X | Gold | Black | 1-2271457-8 | 59.5 | 18.1 | 12.0 |
| 11 | X | Gold | Black | 1-2229803-1 | 82.0 | 18.1 | 12.0 |

※ The 7P connector is a 11P connector with 4 contacts removed.

Double-row Horizontal

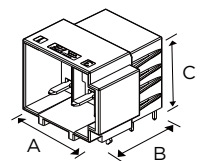

| Pos | Key | Plating | Color | Part Number | Dimensions | | |
|-----|-----|---------|-------|-------------|------------|------|------|
| | | | | | A | B | C |
| 3 | X | Gold | Black | 2229806-1 | 22.0 | 18.1 | 12.0 |

D-4950 Spring Clamp Type

Type Chart

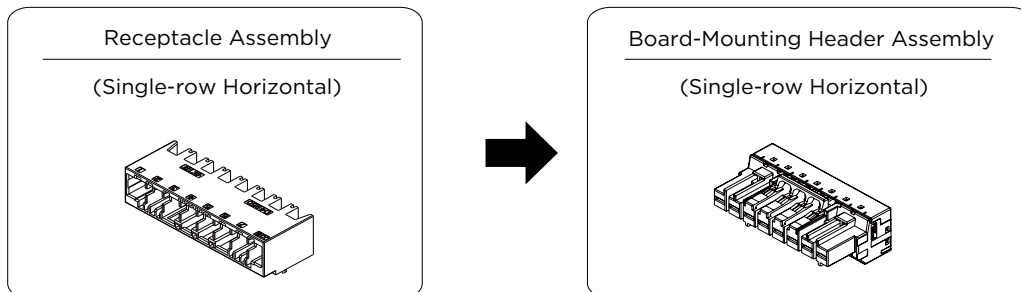

| Pos | Color | Key | Plating | Circuit mark | Receptacle Assembly | Board-Mounting Header Assembly |
|-----|-------|-----|---------|--------------|-----------------------|--------------------------------|
| | | | | | Single-row Horizontal | Single-row Horizontal |
| 8 | Black | X | Gold | Yes | 1-2349849-8 | 1-2349825-8 |

Mated Dimension

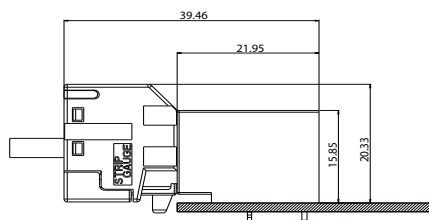

Opener: 2349891-1

External Dimensions

■ Receptacle Assembly

Single-Row Horizontal

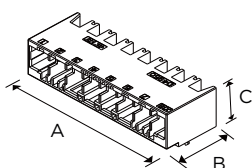

| Pos | Key | Plating | Color | Part Number | Dimensions | | |
|-----|-----|---------|-------|-------------|------------|------|------|
| | | | | | A | B | C |
| 8 | X | Gold | Black | 1-2349849-8 | 61.5 | 31.7 | 22.1 |

■ Board-Mounting Header Assembly

Single-Row Horizontal

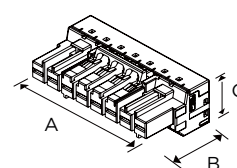

| Pos | Key | Plating | Color | Part Number | Dimensions | | |
|-----|-----|---------|-------|-------------|------------|------|------|
| | | | | | A | B | C |
| 8 | X | Gold | Black | 1-2349825-2 | 61.5 | 22.0 | 15.9 |

On-site Push-in Type

The On-site push-in type series is applicable to the power input and output of servo control systems.

The compact size saves space on the board and facilitates the high-density design of the board. The vertically plugging design and the newly added cable unplugging button make the “tool-free” on-site mounting possible.

The high temperature housing material applicable to reflow soldering and the economical version enrich the choice of connectors for the servo application.

The On-site push-in type series inherits the Dynamic's high reliability, audible & tactile locking system and key design to provide a more efficient solution for the installation process.



•Adopt the standard wiring method as Dynamic series, and Spring clamp type contacts on receptacle side which comply with UL1059.

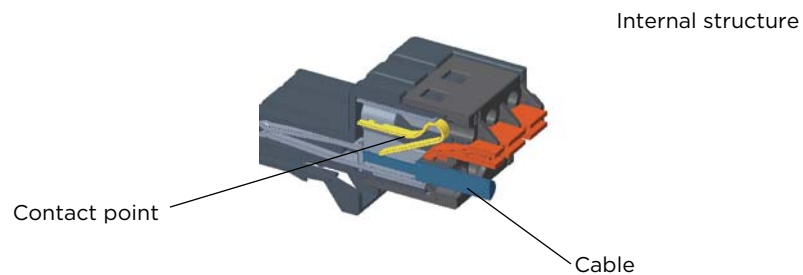

- Applicable to ports of power supply series where a UL508 servo amplifier and inverter, etc. must be used.
- The implementation can be carried out on-site without any crimping tools. Compared to the spiral wiring method, working time is saved significantly.

Product Features

1. Release button design

On-site Push-in type has a release button design, which could support wire inserting and removing of the connector, therefore achieving toolless assembly.

2.Spring clamp contact

The contact is assembled in housing already with a spring clamp design which provide easy on-site installation, therefore increase the efficiency of assembly.

3.High temperature housing material

Housing is made of high temperature material, therefore withstand reflow soldering process.

4. Three different Header options

Three different Headers-including horizontal header, vertical header and reversed header-which fit to varies of application needs.

5. Two plating types

Both gold plating and tin plating contacts balance the high reliability and economical requests.

6.Center locking

This is the first application of a center lock in Dyamic series. On-board space requirements can be mounted in a tight space for high-density mounting on boards requiring signal lines.

7.Audible Latching

Obvious lock sound and feeling when mating means work can be done without mistakes, such as mismating (halfmating), even if the connection cannot be seen.

Spring Clamp Series Performance and Specifications

Performance

| Item | Series | D-2970 |
|---------------------------------|--------|----------------|
| Contact pitch [mm] | | 5.0 |
| Rated current max. UL [A] | | 10 (AWG14 x 1) |
| Rated voltage UL1059 B [V] | | 20 (AWG14 x 1) |
| Rated voltage UL1059 C [V] | | 300 AC/DC |
| Rated voltage UL1059 D [V] | | 400 AC/DC |
| Dielectric withstanding Voltage | | 2,200V AC |
| Wire size [AWG] | | 18-14 |
| Wire size [sq] | | 0.75-2.0 |

Product Specifications

| Item | Series | D-2970 |
|---------------------------|--------|------------|
| Product Specification | | 108-140223 |
| Application Specification | | 408-78171 |

Positions/ Wire size / Rated current

D-2970 Series

| No of energized positions | Current(A) | | | | | | |
|---------------------------|---------------------|--------|--------|--------|--------|--------|--------|
| | AWG 26 With ferrule | AWG 24 | AWG 22 | AWG 20 | AWG 18 | AWG 16 | AWG 14 |
| 3 | 4.5 | 5.5 | 7 | 8 | 9.5 | 11.5 | 15 |
| 4 | 4 | 4.5 | 6 | 7.5 | 9 | 11.5 | 14 |
| Reference UL1059 Limit | 1 | 2 | 3 | 5 | 7 | 10 | 15 |

When spec is over UL1059 limit, UL1059 requirement equipment shall use Limit current.

Materials and Plating

| Description | Material | Finisher |
|---|--------------|---|
| Receptacle contact | Copper alloy | Mating area: 0.38 μ m Gold or 1.0 μ m Tin plating over 1.27 μ m Nickel under-plated |
| Board-mounting header contact | Copper alloy | Mating area: 0.38 μ m Gold plating or 2.5 μ m Tin plating over 1.27 μ m Nickel under-plated Tail area: 2 μ m TIN plating over 1.27 μ m Nickel under-plated |
| Receptacle Housing Board-mounting header Housing | | Liquid Crystal Plastic (LCP), UL94V-0, |

D-2970 On-site Push-in Type

Type Chart

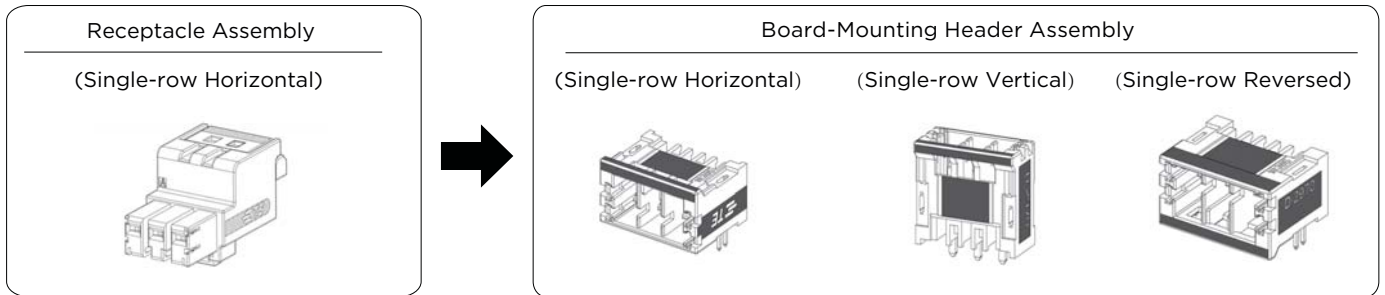

| Pos | Color | Key | Plating | Board Mounting Header Assembly | | | |
|-----|-------|-----|---------|--|-----------------------|---------------------|---------------------|
| | | | | Receptacle Assembly Single-Row Horizontal | Single-Row Horizontal | Single-row Vertical | Single-row Reversed |
| 3 | Black | X | Tin | 2336488-3 | 2336490-3 | 2336494-3 | 2336491-3 |
| 3 | Black | X | Gold | 2-2336488-3 | 2-2336490-3 | 2-2336494-3 | 2-2336491-3 |
| 4 | Black | X | Tin | 2336488-4 | 2336490-4 | 2336494-4 | 2336491-4 |
| 4 | Black | X | Gold | 2-2336488-4 | 2-2336490-4 | 2-2336494-4 | 2-2336491-4 |

Mated Dimension

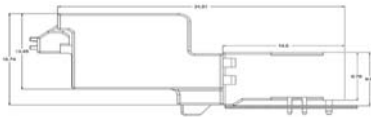

Single-Row Horizontal

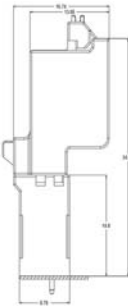

Single-row Vertical



Single-row Reversed

External Dimensions

Receptacle Assembly Single-Row Horizontal

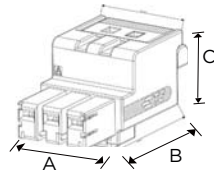

| Pos | Key | Plating | Color | Part Number | Dimensions | | |
|-----|-----|---------|-------|-------------|------------|----|------|
| | | | | | A | B | C |
| 3 | X | Tin | Black | 2336488-3 | 17 | 34 | 18.7 |
| 3 | X | Gold | Black | 2-2336488-3 | 17 | 34 | 18.7 |
| 4 | X | Tin | Black | 2336488-4 | 22 | 34 | 18.7 |
| 4 | X | Gold | Black | 2-2336488-4 | 22 | 34 | 18.7 |

Single-Row Vertical

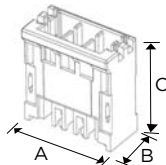

| Pos | Key | Plating | Color | Part Number | Dimensions | | |
|-----|-----|---------|-------|-------------|------------|-----|------|
| | | | | | A | B | C |
| 3 | X | Tin | Black | 2336494-3 | 19.9 | 9.8 | 14.8 |
| 3 | X | Gold | Black | 2-2336494-3 | 19.9 | 9.8 | 14.8 |
| 4 | X | Tin | Black | 2336494-4 | 24.9 | 9.8 | 14.8 |
| 4 | X | Gold | Black | 2-2336494-4 | 24.9 | 9.8 | 14.8 |

Board-Mounting Header Assembly Single-Row Horizontal

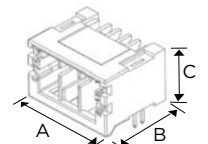

| Pos | Key | Plating | Color | Part Number | Dimensions | | |
|-----|-----|---------|-------|-------------|------------|------|-----|
| | | | | | A | B | C |
| 3 | X | Tin | Black | 2336490-3 | 19.9 | 14.8 | 9.8 |
| 3 | X | Gold | Black | 2-2336490-3 | 19.9 | 14.8 | 9.8 |
| 4 | X | Tin | Black | 2336490-4 | 24.9 | 14.8 | 9.8 |
| 4 | X | Gold | Black | 2-2336490-4 | 24.9 | 14.8 | 9.8 |

Single-Row Reversed

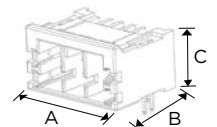

| Pos | Key | Plating | Color | Part Number | Dimensions | | |
|-----|-----|---------|-------|-------------|------------|------|-----|
| | | | | | A | B | C |
| 3 | X | Tin | Black | 2336491-3 | 19.9 | 14.8 | 9.8 |
| 3 | X | Gold | Black | 2-2336491-3 | 19.9 | 14.8 | 9.8 |
| 4 | X | Tin | Black | 2336491-4 | 24.9 | 14.8 | 9.8 |
| 4 | X | Gold | Black | 2-2336491-4 | 24.9 | 14.8 | 9.8 |

NOTE: all products are RoHS compliant On selection.

Tap Connector: Dyna-Tap Connectors

The common FA equipment is a device formed by combining functionally separated units in a final process. Tap on the circuit board was the original method used for supplying power to each unit.

Therefore, TE developed a tap connector with tap function—Dyna-Tap, which will not further burden the circuit board of which the space should be further saved in the future.

Dyna-Tap Connectors is a Dynamic series tap connector developed as an FA power connector, so it is the most suitable product for tap of the main power cable. (An application has been made for the design of its appearance)

Its specification is 6P to support the tap of the 3-phase power cable system widely used in the industry.

The relay type and panel type of the product has been developed. The matching model is 1-178288-6.

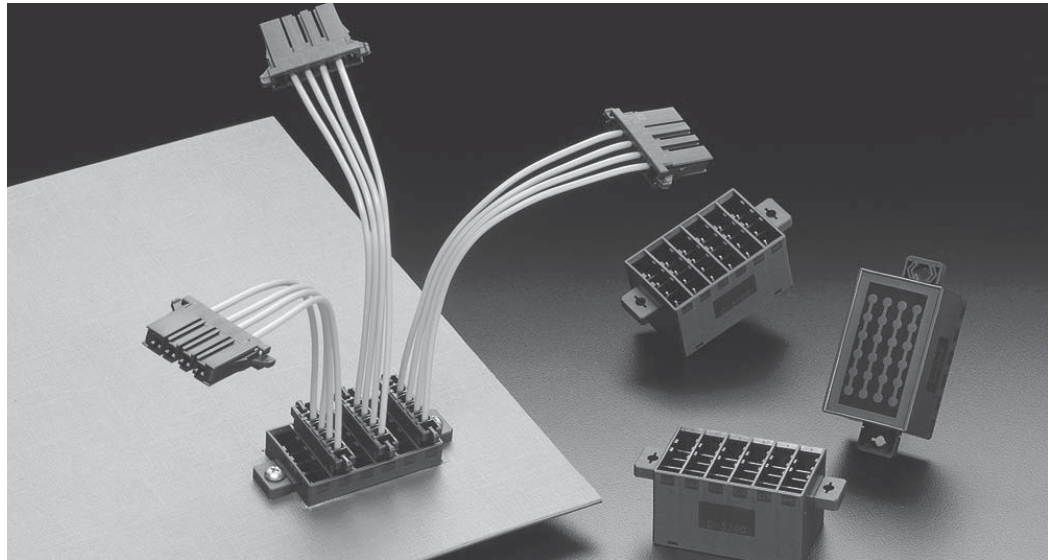

D-3100 Dyna-Tap18P(6Px3ROW)

Highlight

Since in most applications it is fixed outside the circuit board (chassis), a dust cover is installed to prevent dust from entering the inside of the housing. Therefore, it can be used in harsh environments.

Application

- Power tap in the elevator control room
- Power tap of power protection relays, etc.
- Power tap in the semiconductor production equipment unit room
- Power supply for production line equipment

Performance

- Rated voltage: 250V AC/DC
- Rated current: 8A (when the 18P and AWG#14 are used)
- No of Pos.: 6Px3 = 18P (6P tap)
- Durability 500 cycles
- Product standard: 108-5754

D-3200 Dyna-Tap24P(4Px6ROW)

Highlight 1

The Dynamic series connectors and contacts can be used. It is a power supply board that uses the Dynamic series (D-3200S 4P REC) with excellent connection reliability and gain high reputation. Compared to terminal blocks, its installation and maintenance costs are reduced significantly. Meanwhile, compatible terminals enable less costs of use and inventory.

Highlight 2

Positions of Power board installation can be set freely. Considering that the relay type and panel type connectors are used jointly, panel type with fixtures near to opener or bottom are both available.

Highlight 3

Cost advantage by reducing number of components used and saving working hours on installation.

Other highlights

- The Tin plated and Gold-plated type (0.38 mm) are provided.
- The back is engraved with an electrical connection diagram.

D-3100 Dyna-Tap 18P(6Px3ROW), 24P(6Px4ROW)

Type Chart

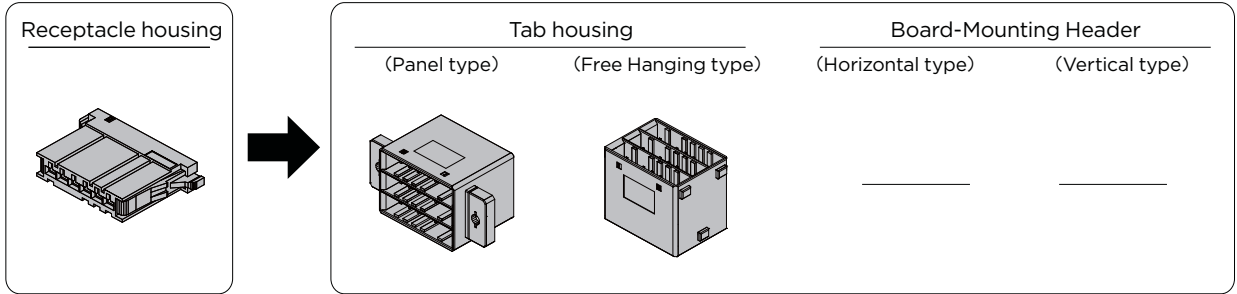

| Pos | Color | Key | Receptacle housing | Tab housing | | Through-hole | Plating | | Board-Mounting Header | |
|-----|-------|-----|--------------------|-------------|-------------------|--------------|-----------------|---------------|-----------------------|---|
| | | | | Panel type | Free Hanging type | | Horizontal type | Vertical type | | |
| 6 | Black | X | 1-178288-6 | — | — | — | — | — | — | — |
| 18 | Black | X | — | 1376807-2 | 1376807-1 | — | — | — | — | — |
| 24 | Black | X | — | — | — | 1971003-1 | — | — | — | — |
| | Black | X | — | — | — | 1971003-2 | — | — | — | — |

Mated Dimension

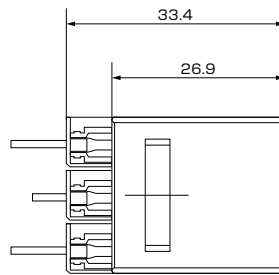

Panel type/Free Hanging type

External Dimensions

Receptacle Housing

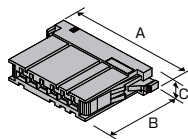

| Pos | Key | Color | Part Number | Dimensions | | |
|-----|-----|-------|-------------|------------|------|-----|
| | | | | A | B | C |
| 6 | X | Black | 1-178288-6 | 38.2 | 22.8 | 7.2 |

Through-hole

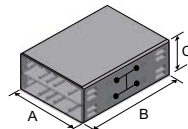

| Pos | Key | Color | Part Number | Dimensions | | |
|-----|-----|-------|-------------|------------|------|------|
| | | | | A | B | C |
| 24 | X | Black | 1971003-1 | 33.1 | 45.7 | 17.1 |
| | X | Black | 1971003-2 | 35.1 | 45.7 | 35.1 |

NOTE: all products are RoHS compliant On selection.

Board-Mounting Header

Panel type

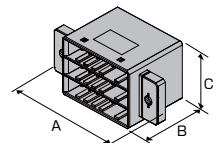
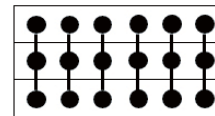

| Pos | Key | Plating | Color | Part Number | Dimensions | | |
|-----|-----|---------|-------|-------------|------------|------|------|
| | | | | | A | B | C |
| 18 | X | Gold | Black | 1376807-2 | 51.0 | 26.9 | 24.6 |

Free Hanging type

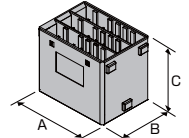

| Pos | Key | Plating | Color | Part Number | Dimensions | | |
|-----|-----|---------|-------|-------------|------------|------|------|
| | | | | | A | B | C |
| 18 | X | Gold | Black | 1376807-1 | 33.1 | 24.6 | 26.9 |

D-3200 Dyna-Tap 24P(4Px6ROW)

Type Chart

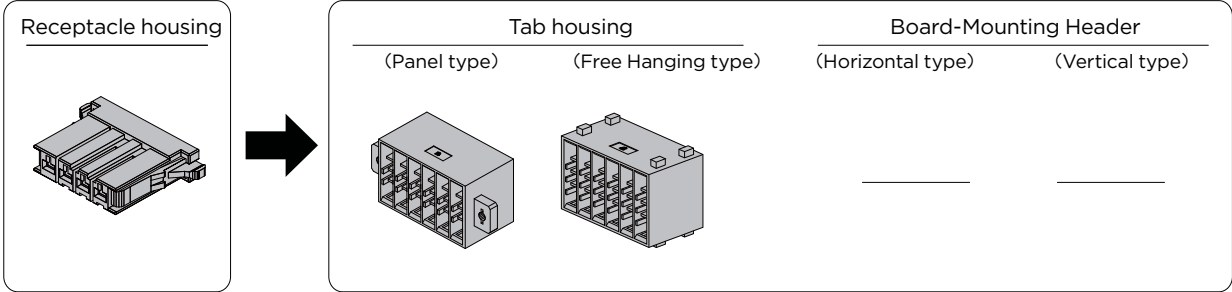

| Pos | Color | Key | Receptacle housing | Tab housing | | Plating | Board-Mounting Header | |
|-----|-------|-----|--------------------|---------------|-------------------|---------|-----------------------|---------------|
| | | | | Panel type | Free Hanging type | | Horizontal type | Vertical type |
| 4 | Black | X | 1-178128-4 | — | — | — | — | — |
| 24 | Black | X | — | 1827691-2×1 | 1827691-1 | Gold | — | — |
| | Black | X | — | 1-1827691-2×1 | 1-1827691-1 | Tin | — | — |
| | Black | X | — | 1827691-3×2 | — | Gold | — | — |
| | Black | X | — | 1-1827691-3×2 | — | Tin | — | — |

Mated Dimension

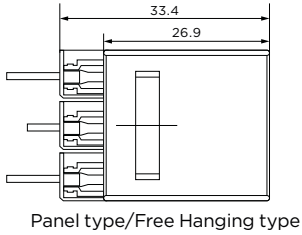

Panel type/Free Hanging type

External Dimensions

Receptacle Housing

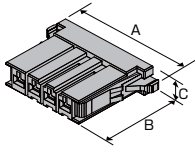

| Pos | Key | Color | Part Number | Dimensions | | |
|-----|-----|-------|-------------|------------|------|-----|
| | | | | A | B | C |
| 4 | X | Black | 1-178128-4 | 24.6 | 22.8 | 7.2 |

Tab housing

Panel type

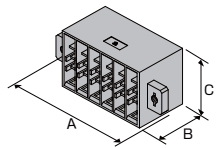
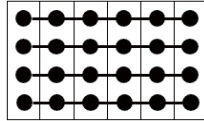

| Pos | Key | Plating | Color | Part Number | Dimensions | | |
|-----|-----|---------|-------|-------------|------------|------|------|
| | | | | | A | B | C |
| 24 | X | Gold | Black | 1827691-2 | 65.0 | 26.9 | 29.2 |
| | X | Tin | Black | 1-1827691-2 | | | |
| | X | Gold | Black | 1827691-3 | | | |
| | X | Tin | Black | 1-1827691-3 | | | |

Free Hanging type

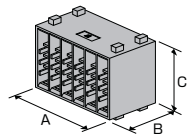

| Pos | Key | Plating | Color | Part Number | Dimensions | | |
|-----|-----|---------|-------|-------------|------------|------|------|
| | | | | | A | B | C |
| 24 | X | Gold | Black | 1827691-1 | 47.5 | 26.9 | 29.2 |
| | X | Tin | Black | 1-1827691-1 | | | |

NOTE: all products are RoHS compliant On selection.

D-4000 Series

Series introduction

It is a connector most appropriate for industrial equipment equipped with 20A power cords. The optimum size meets the compactness and high current requirements of the equipment.

The terminal is newly designed to have 4 contact points.

Compared with the Dynamic3000 series, it can ensure a current of above 50% while only increase 14% in mated height, so that miniaturization is achieved. Compared to existing products, each positions has a current capacity increased by about 32%.

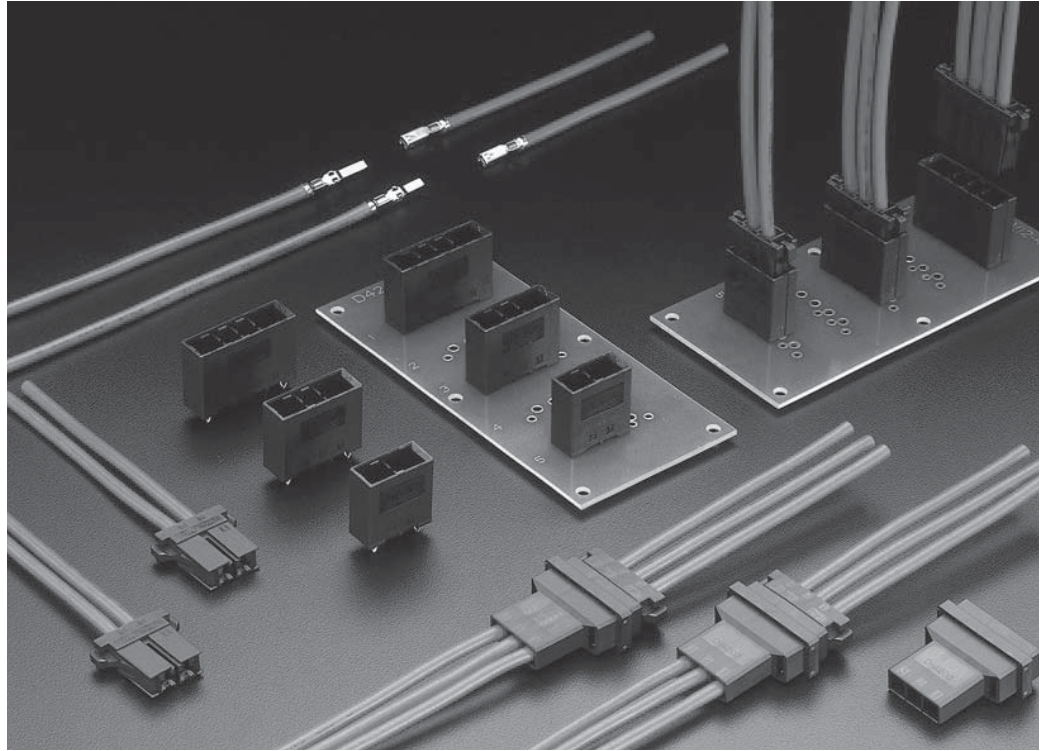

Product Features

1. Small Size/High Current Contact

The contacts are newly-designed with 4 points of contact. This allows significantly improved current capacity (rated 20A maximum) as well as reliability.

2. The sequential contacts

The sequential contact is a longer tab contact. When used in connection with the regular contacts it provides a ground that mates before the other power contacts.

3. High current contact

New V shape contact were developed for mounting on boards with larger contact area while smaller through-holes. Even though a lot of on-board connection space is needed, through-holes were made as small as possible to make pattern design easily.

4. Audible Latching

On mating, an audible lock sound and sensation is transmitted to the assembler, so that even when working 'blind' mis-mating (or half-mating) problems are avoided.

5. Key

The housing has a keying (slit), so that by separating use of the X key and Y key mis-Mating is prevented.

D-4000 Series Performance and Specifications

Performance

| | |
|-----------------------|--|
| Item \ Pitch | 250mils 6.35mm |
| Rated Voltage | 600V AC(rms)/DC |
| Rated Current | 2P: 24A 3P: 23A 4P: 22A (AWG#12 for use as powersource) |
| Contact Resistance | 10mff Max |
| Withstanding Voltage | 2,500V AC(1 min) |
| Operating Temperature | -55°C ~+105°C |

Positions/Wire Size/Rated Current

Unit: A(Amps)

| Position | Wire Size(AWG) | | |
|----------|----------------|----|----|
| | 12 | 14 | 16 |
| 2 | 24 | 21 | 16 |
| 3 | 23 | 20 | 15 |
| 4 | 22 | 19 | 14 |

Product Specification

| | | |
|--|----------------------------|-----------|
| Product Specifications | 108-78182 | |
| Applications Specifications | 114-5369 | |
| Hand tool application specification | Part number: 1762130-1 (M) | 411-78174 |
| | Part number: 1762129-1 (L) | 411-78173 |
| Unplugging tool (1762461-1) operating manual | 411-78186 | |

When applicable, please be sure to order the operating manual. It can also be found in the online electronic specifications catalog.

Materials and Plating

| Category | Materials | Plating |
|-----------------------------------|--|---|
| Receptacle Contact Tab Contact | Phosphor bronze or copper alloy | 0.38µm gold-plating over Nickel under-plated |
| Board Mount Header | Phosphor bronze or copper alloy | Gold plating over Nickel under-plated Tin plating on tail side |
| Housing | UL94V-0, reinforced thermoplastic PBT with glass fiber | |

Safety Standards

The safety specifications listed below are approved on specific part numbers. Please contact our Technical Support Centre to check whether the part numbers you use are approved or not. Keep in mind that there are instances where values differ from those given by Tyco Electronics Specifications.

| Standard | Series | D-4200 | | | | | | | | | | |
|----------------------------------|--|--|-------------------|--------|----|----|----|----|----|----|---------------|--|
| | Rated Voltage | Rated Current | Temperature Range | | | | | | | | | |
| Product Specifications 108-78182 | 600V AC/DC | 24A AWG#12 2P | -55°C ~+105°C | | | | | | | | | |
| UL File No.E28476 | Based on the requirements of Application | Based on the requirements of Application | - | | | | | | | | | |
| CSA Report No. LR 7189 | 600V AC/DC | 24A | - | | | | | | | | | |
| TÜV License No. R 50084673 | 600V AC/DC | <table border="1"> <tr> <th>AWG</th> <th>A(2 P)</th> </tr> <tr> <td>12</td> <td>24</td> </tr> <tr> <td>14</td> <td>21</td> </tr> <tr> <td>16</td> <td>16</td> </tr> </table> | AWG | A(2 P) | 12 | 24 | 14 | 21 | 16 | 16 | -55°C ~+105°C | |
| AWG | A(2 P) | | | | | | | | | | | |
| 12 | 24 | | | | | | | | | | | |
| 14 | 21 | | | | | | | | | | | |
| 16 | 16 | | | | | | | | | | | |

D-4000 Series Configurations

D-4200S

High Current

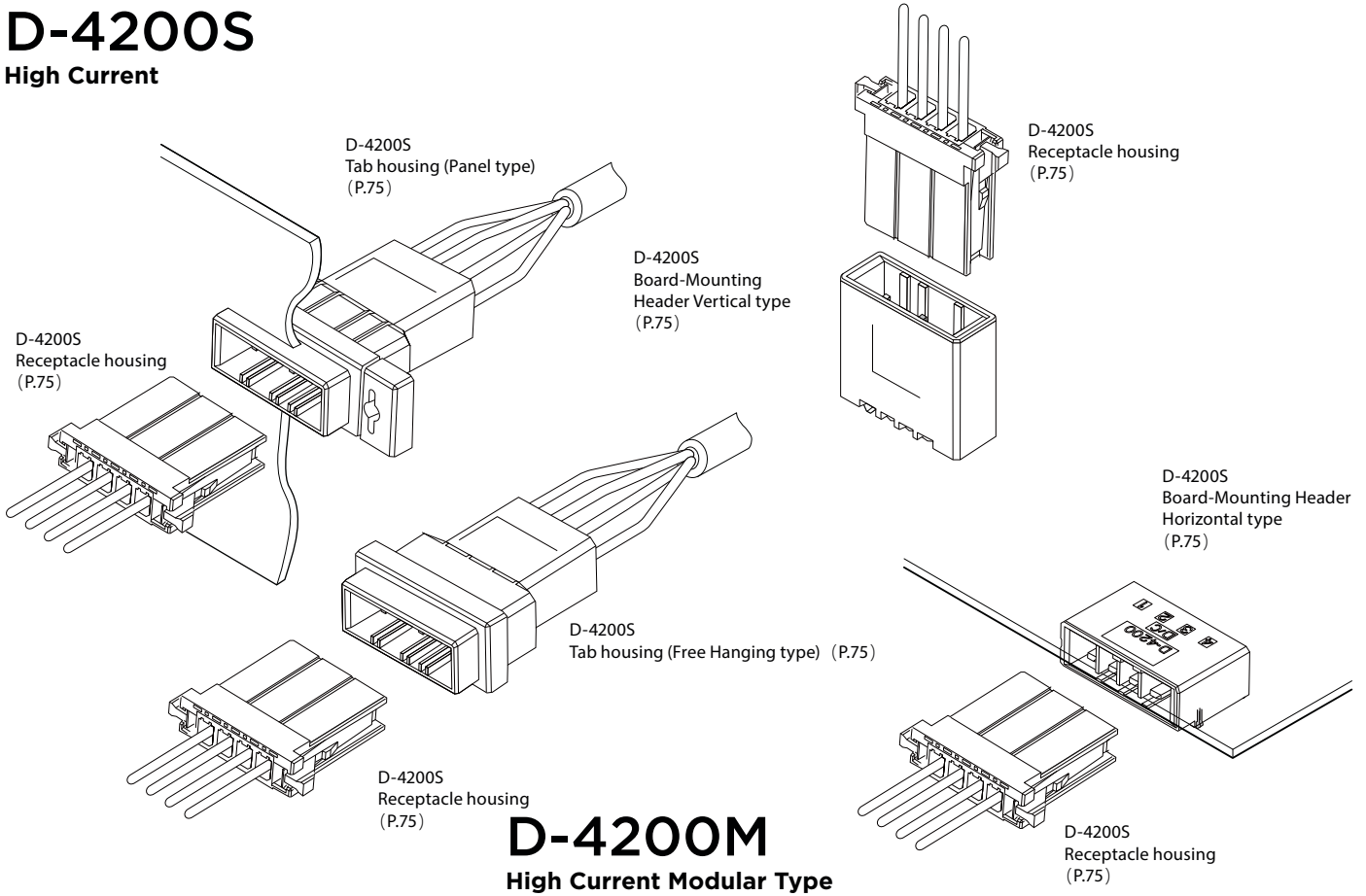

D-4200M

High Current Modular Type

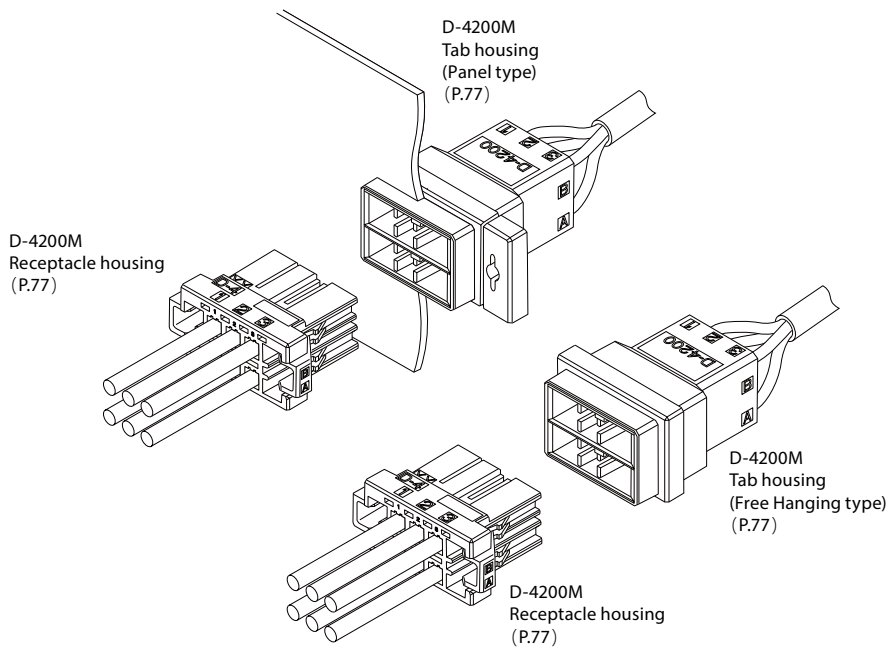

D-4000 Series Contact

■ Crimped Types

(Gold plating thickness 0.38 µm)

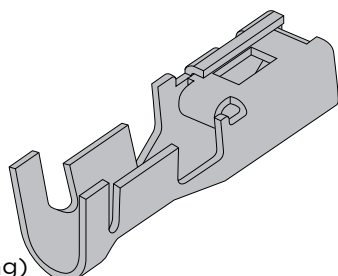

Receptacle Contact
(Used in Receptacle housing)

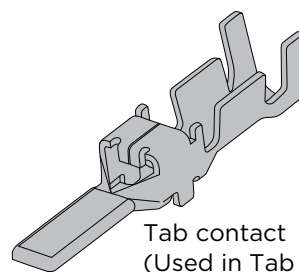

Tab contact
(Used in Tab housing)

| Wire Range | | Outside Diameter of Insulation mm | Wire Range Mark | Contacts | | | | | | Applicable tools | | |
|------------|-----------------|-----------------------------------|-----------------|--------------------|-------------|-------------|-------------|-----------------------------|-------------|---|--|-----------|
| | | | | Receptacle Contact | | Tab Contact | | Sequential LongTab contacts | | Hand tool CCII hand tool PEW12 hand tool* PEW12 dice only | Mini-Applicator | |
| AWG | mm ² | | | Strip form | Loose Piece | Strip form | Loose Piece | Strip form | Loose Piece | | | |
| 22 | 0.30 | 1.58-2.38 | SS* | | 2287721-2 | 2288020-1 | 2287732-2 | 2288019-1 | 1-2287732-2 | 1-2288019-1 | --- | --- |
| 20 | 0.50 | 1.76-2.56 | | | | | | | | | | |
| 20 | 0.50 | 1.8-2.7 | S | | 2040015-2 | 2040587-1 | 2040016-2 | 2040586-1 | 1-2040016-1 | 1-2040586-1 | 2266289-1 | 2047670-1 |
| 18 | 0.85 | | | | | | | | | | | |
| 16 | 1.42 | | | | | | | | | | | |
| 16 | 1.25 | 2.0-3.2 2.8-3.75 | M | | 1747418-2 | 1747499-2 | 1747419-2 | 1747501-2 | 1-1747419-2 | 1-1747501-2 | 1762130-1 1762671-1* (1762675-1) | 1762120-2 |
| 14 | 2.20 | | | | | | | | | | | |
| 14 | 2.20 | 2.9-3.8 3.8-4.2 | L | | 1747415-2 | 1747498-2 | 1747416-2 | 1747500-2 | 1-1747416-2 | 1-1747500-2 | 1762129-1 1762670-1* (1762674-1) | 1762119-2 |
| 12 | 3.50 | | | | | | | | | | | |

Note * The gold plating thickness of the corresponding terminal is 0.76 µm, and the gold plating thickness of the corresponding terminal of which the wire diameter and model are not noted.

Please contact our sales department or distributor for more information.

Strip Form contacts are used with Mini-applicators (bench machine) and Loose-Piece contacts are with hand tools.

PEW 12 is an exchange-type hand tool. *refers to the exchange-type hand tool with product number - 9-1478240-0

The receptacle contact can be used in all receptacle housings, the tab contact can be used in all tab housings. Details of the applicable tool are available from P. 107-111.

NOTE: all products are RoHS compliant On selection.

D-4200S Single-row High Voltage

Type Chart

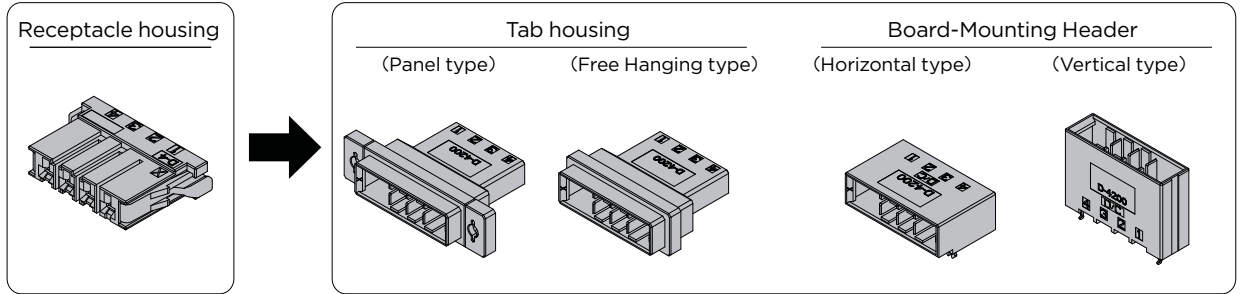

| Pos | Color | Key | Receptacle housing | Tab housing | | Plating | Board-Mounting Header | | | |
|-----|-------|-----|--------------------|-------------|-------------------|---------|-----------------------|-------------|---------------|-------------|
| | | | | Panel type | Free Hanging type | | Horizontal type | | Vertical type | |
| | | | | | | | Standard | Sequential | Standard | Sequential |
| 2 | Black | X | 1-1747276-2 | 1-1747535-2 | 1-1747414-2 | Gold | 1-1903328-2 | — | 1-1747277-2 | — |
| | Black | Y | 2-1747276-2 | 2-1747535-2 | 2-1747414-2 | Gold | 2-1903328-2 | — | 2-1747277-2 | — |
| 3 | Black | X | 1-1747276-3 | 1-1747535-3 | 1-1747414-3 | Gold | 1-1903328-3 | 5-1903328-3 | 1-1747277-3 | 5-1747277-3 |
| | Black | Y | 2-1747276-3 | 2-1747535-3 | 2-1747414-3 | Gold | 2-1903328-3 | 6-1903328-3 | 2-1747277-3 | 6-1747277-3 |
| 4 | Black | X | 1-1747276-4 | 1-1747535-4 | 1-1747414-4* | Gold | 1-1903328-4 | 5-1903328-4 | 1-1747277-4 | 5-1747277-4 |
| | Black | Y | 2-1747276-4 | 2-1747535-4 | 2-1747414-4* | Gold | 2-1903328-4 | 6-1903328-4 | 2-1747277-4 | 6-1747277-4 |

*DIN rail attachment is available, P/N 2822901-1

Relative Product Information

Applicable contact...P.74

Performance & Specifications...P.72

Applications

Example of Robot/Robot Controller Application

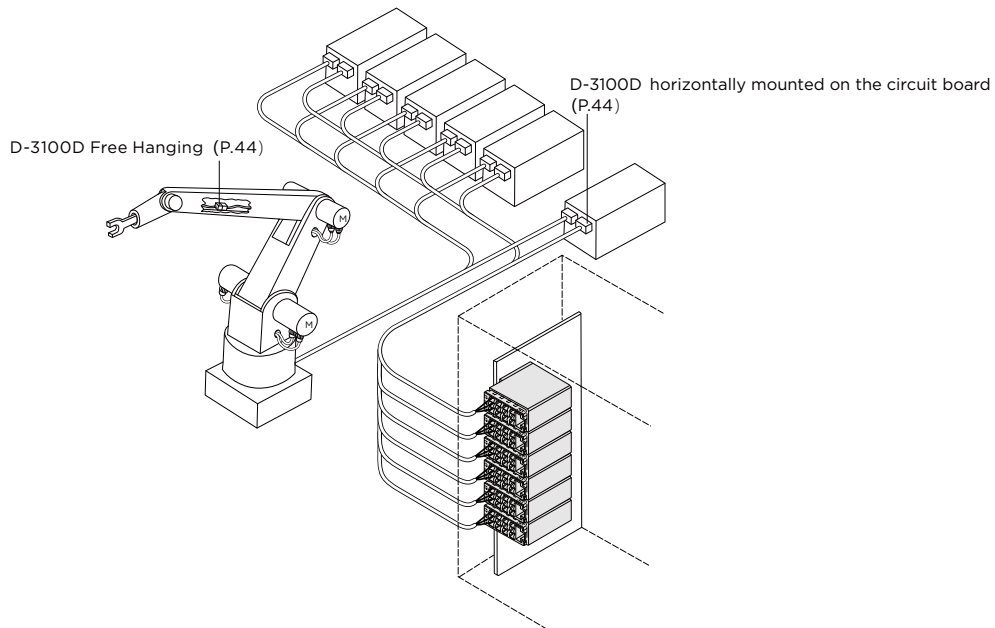

NOTE: all products are RoHS compliant On selection.

D-4200S Single-row High Voltage

Mated Dimension

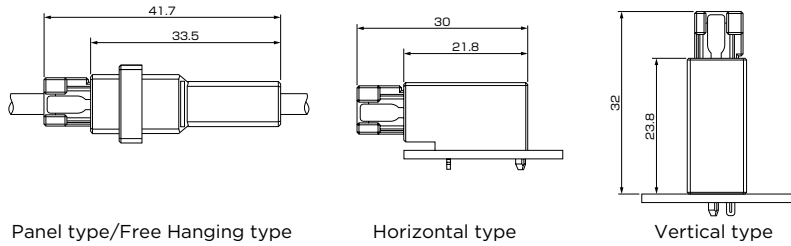

Panel type/Free Hanging type

Horizontal type

Vertical type

External Dimensions

Receptacle Housing

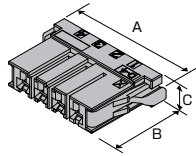

| Pos | Key | Color | Part Number | Dimensions | | |
|-----|-----|-------|-------------|------------|------|-----|
| | | | | A | B | C |
| 2 | X | Black | 1-1747276-2 | 27.4 | 23.0 | 8.5 |
| | Y | Black | 2-1747276-2 | | | |
| 3 | X | Black | 1-1747276-3 | 33.7 | 23.0 | 8.5 |
| | Y | Black | 2-1747276-3 | | | |
| 4 | X | Black | 1-1747276-4 | 40.1 | 23.0 | 8.5 |
| | Y | Black | 2-1747276-4 | | | |

Tab Housing

Panel type

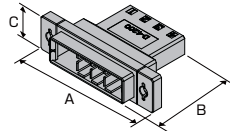

| Pos | Key | Color | Part Number | Dimensions | | |
|-----|-----|-------|-------------|------------|------|------|
| | | | | A | B | C |
| 2 | X | Black | 1-1747535-2 | 40.0 | 33.5 | 13.8 |
| | Y | Black | 2-1747535-2 | | | |
| 3 | X | Black | 1-1747535-3 | 46.0 | 33.5 | 13.8 |
| | Y | Black | 2-1747535-3 | | | |
| 4 | X | Black | 1-1747535-4 | 53.0 | 33.5 | 13.8 |
| | Y | Black | 2-1747535-4 | | | |

Free Hanging type

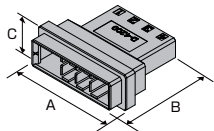

| Pos | Key | Plating | Color | Part Number | Dimensions | | |
|-----|-----|---------|-------|-------------|------------|------|------|
| | | | | | A | B | C |
| 2 | X | — | Black | 1-1747414-2 | 26.4 | 33.5 | 13.8 |
| | Y | — | Black | 2-1747414-2 | | | |
| 3 | X | — | Black | 1-1747414-3 | 32.7 | 33.5 | 13.8 |
| | Y | — | Black | 2-1747414-3 | | | |
| 4 | X | — | Black | 1-1747414-4 | 39.1 | 33.5 | 13.8 |
| | Y | — | Black | 2-1747414-4 | | | |

NOTE: all products are RoHS compliant On selection.

Board-Mounting Header

Horizontal type

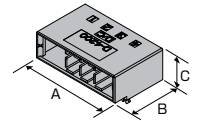

| Pos | Key | Plating | Color | Part Number | Dimensions | | |
|-----|-----|---------|-------|---------------|------------|------|------|
| | | | | | A | B | C |
| 2 | X | Gold | Black | 1-1903328-2 | 22.4 | 21.8 | 11.9 |
| | Y | Gold | Black | 2-1903328-2 | | | |
| 3 | X | Gold | Black | 1-1903328-3 | 28.7 | 21.8 | 11.9 |
| | Y | Gold | Black | 2-1903328-3 | | | |
| | X | Gold | Black | 5-1903328-3×1 | | | |
| | Y | Gold | Black | 6-1903328-3×1 | | | |
| 4 | X | Gold | Black | 1-1903328-4 | 35.1 | 21.8 | 11.9 |
| | Y | Gold | Black | 2-1903328-4 | | | |
| | X | Gold | Black | 5-1903328-4×1 | | | |
| | Y | Gold | Black | 6-1903328-4×1 | | | |

×1 Sequential type

Vertical type

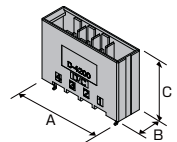

| Pos | Key | Plating | Color | Part Number | Dimensions | | |
|-----|-----|---------|-------|---------------|------------|------|------|
| | | | | | A | B | C |
| 2 | X | Gold | Black | 1-1747277-2 | 22.4 | 10.4 | 23.8 |
| | Y | Gold | Black | 2-1747277-2 | | | |
| 3 | X | Gold | Black | 1-1747277-3 | 28.7 | 10.4 | 23.8 |
| | Y | Gold | Black | 2-1747277-3 | | | |
| | X | Gold | Black | 5-1747277-3×1 | | | |
| | Y | Gold | Black | 6-1747277-3×1 | | | |
| 4 | X | Gold | Black | 1-1747277-4 | 35.1 | 10.4 | 23.8 |
| | Y | Gold | Black | 2-1747277-4 | | | |
| | X | Gold | Black | 5-1747277-4×1 | | | |
| | Y | Gold | Black | 6-1747277-4×1 | | | |

×1 Sequential type

D-4200M Double-row High Current Modular Type

Type Chart

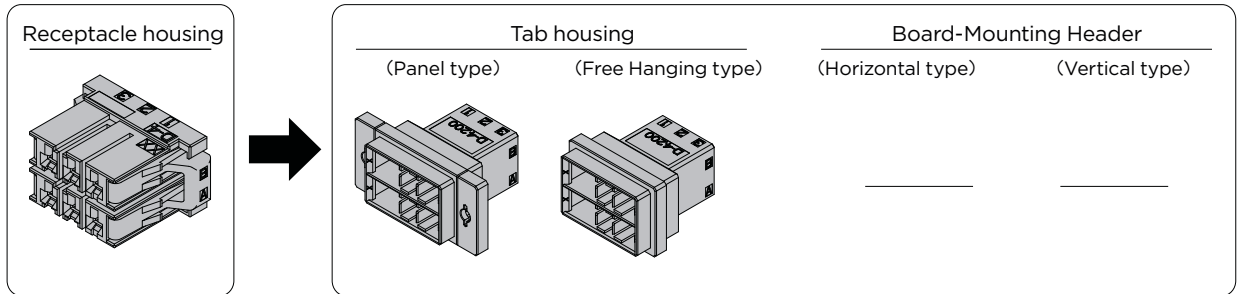

| Pos | Color | Key | Receptacle housing | Tab housing | | Plating | Board-Mounting Header | |
|-----|-------|-----|--------------------|-------------|-------------------|---------|-----------------------|---------------|
| | | | | Panel type | Free Hanging type | | Horizontal type | Vertical type |
| 6 | Black | XX | 1-1903329-3 | 1-1903331-3 | 1-1903330-3 | — | — | — |
| | Black | YY | 2-1903329-3 | 2-1903331-3 | 2-1903330-3 | — | — | — |
| | Black | XY | 3-1903329-3 | 3-1903331-3 | 3-1903330-3 | — | — | — |

Relative Product Information

Applicable contact...P.74
Performance & Specifications...P.72

Mated Dimension

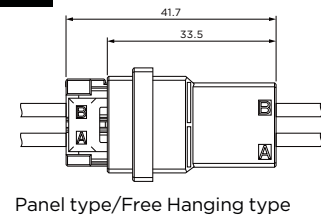

Panel type/Free Hanging type

External Dimensions

Receptacle Housing

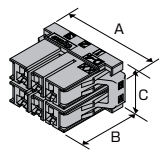

| Pos | Key | Color | Part Number | Dimensions | | |
|-----|-----|-------|-------------|------------|------|------|
| | | | | A | B | C |
| 6 | XX | Black | 1-1903329-3 | 33.7 | 23.0 | 17.3 |
| | YY | Black | 2-1903329-3 | | | |
| | XY | Black | 3-1903329-3 | | | |

Tab Housing

Panel type

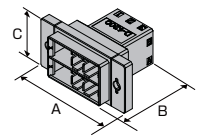

| Pos | Key | Color | Part Number | Dimensions | | |
|-----|-----|-------|-------------|------------|------|------|
| | | | | A | B | C |
| 6 | XX | Black | 1-1903331-3 | 46.0 | 33.5 | 22.6 |
| | YY | Black | 2-1903331-3 | | | |
| | XY | Black | 3-1903331-3 | | | |

Free Hanging type

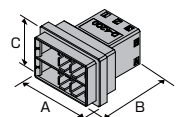

| Pos | Key | Color | Part Number | Dimensions | | |
|-----|-----|-------|-------------|------------|------|------|
| | | | | A | B | C |
| 6 | XX | Black | 1-1903330-3 | 32.7 | 33.5 | 22.6 |
| | YY | Black | 2-1903330-3 | | | |
| | XY | Black | 3-1903330-3 | | | |

NOTE: all products are RoHS compliant On selection.

D-5000 Series

Series introduction

The Dynamic 5000 series was developed for up to 45 amperes in response to the demand for improved reliability and productivity for the main power lines in equipment.

They can be used for a variety of applications as replacements for terminal blocks, or round terminals. It is compact but with a high current capacity.

In addition, it has a wide variety of housings to cover all applications from PCB to internal wiring distributions. The D-5000 series is right for high current power line applications where reliability cannot rely on operator's skills

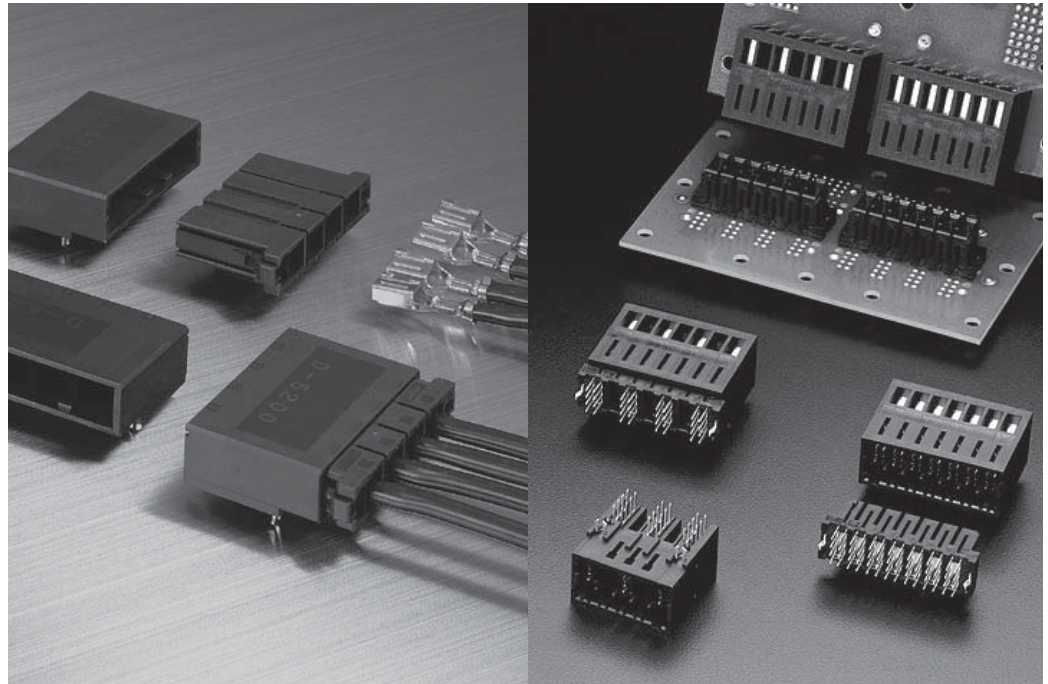

Product Features

1. High Current Contact

The D-5000 series uses the same 'twis-resistant, box shape contact' as the rest of the Dynamic series contacts. The material is the same copper alloy developed for the D-3000 series with its superior elasticity and conductivity, which results in a reliable, robust contact capable of high current. Silver plating is also available for high amperage applications.

2. Sequential Connection

The Sequential Mating means that the build up of static charge in the sequential contact is grounded first at mating. The long tab was developed for sequential connection of tab contacts. By using both this long tab contact and standard tab contacts, sequential connectivity is enhanced.

3. Contact for High Amperage

The contact for on-board mounting are a newly developed twin-lead type. It is possible to reliably join patterns and connectors because a wide area of PCBs can be allocated. New V shape contacts were developed for mounting on boards. Even though a lot of on-board connection space is needed, through-holes were made as small as possible to make pattern design easily (patent pending).

4. IP20 (Protection from the approach of the finger)

D-5300 is recommended for applications with a supply side in the IP20 apparatus. By using a housing on the apparatus side (panel side) which can accommodate the receptacle contact, the apparatus side connector meets IP20 requirement.

D-5000 Series Performance and Specifications

Performance

| Item | D-5200 | D-5300 | D-5200α |
|----------------------|-------------------------------|--------|--------------|
| Pitch | 10.16mm | | |
| Rated Current | Maximum: 35A | | Maximum: 45A |
| Rated Voltage | 630V AC / DC | | |
| Withstanding Voltage | 3000 VAC | | |
| Total resistance | Maximum: 2mff | | |
| Insertion strength: | Maximum (per position): 9.8N | | |
| Withdrawal strength | Minimum (per position): 1.96N | | |
| Durability | 50 cycles (0.76 μm Gold) | | |
| Locking strength | Minimum: 98N | | |

Position/Wire Size/Rated Current

Unit: A(Amps)

| Pos | Series | Wire Size(AWG) | | | | | | |
|-----|---------|----------------|----|----|----|----|----|----|
| | | 20 | 18 | 16 | 14 | 12 | 10 | 8 |
| 6 | D-5200 | — | — | 16 | 19 | 25 | 30 | — |
| 4 | D-5300 | — | — | — | — | — | — | — |
| 3 | D-5200α | 12 | 16 | 20 | 25 | 33 | 38 | 45 |
| 4 | | 12 | 15 | 18 | 23 | 31 | 35 | 43 |

Performance Specifications

| | | |
|--|------------------------|------------|
| Product Specifications | 108-5453 | |
| Test Report | 501-5188 | |
| Applications Specifications | 114-5206 | |
| Hand tool manual | Part number: 234170-1 | 411-5712 |
| | Part number: 234171-1 | 411-5713 |
| | Part number: 91596-1 | 408-8547-1 |
| | Part number: 1366044-1 | 411-5976 |
| Unplugging tool (model: 409158-1) operation manual | 411-5774 | |

When applicable, please be sure to order the operating manuals. It can also be found in the online electronic specifications catalog.

Material and Plating

| Category | Item | D-5200 | D-5300 | D-5200α |
|---------------------------------------|-----------|---|--|---------------------------------------|
| Receptacle Contacts Tab Contact | Materials | Copper alloys | | |
| | Plating | Gold Plating with Nickel under-plated | Gold/Silver Plating with Nickel under-plated | Gold Plating with Nickel under-plated |
| Board Mount Header | Materials | Copper alloys | — | Copper alloy |
| | Plating | Gold Plating with Nickel under-plated | — | Gold Plating with Nickel under-plated |
| Housing | Materials | UL94V-0, glass fiber reinforced thermoplastic PBT | | |

Safety Standards

The safety specifications listed below are approved on specific part numbers. Please contact our Technical Support Centre to check whether the part numbers you use are approved or not. Keep in mind that there are instances where values differ from those given by Tyco Electronics Specifications.

| ST.D. | Series | D-5200Series(10.16mmPitch) | | | D-5200MαSeries | | | | | | | | | | | | | | | | | | | | | | | | | | | | | | | | | | | | | | |
|--|--------|--|--|-------------------|----------------|--|-------------------|----|----|----|----|----|----|---------------|---|--|-----|---|--|-------|--------------|----|------|------|----|------|----|----|----|------|----|----|----|----|----|----|----|----|------|---|----|----|---------------|
| | | Rated Voltage | Rated Current | Temperature Range | Rated Voltage | Rated Current | Temperature Range | | | | | | | | | | | | | | | | | | | | | | | | | | | | | | | | | | | | |
| Product Specifications 108-5453 | | 630V AC/DC | (As shown above) | -55°C ~+105°C | — | (As shown above) | -55°C ~+105°C | | | | | | | | | | | | | | | | | | | | | | | | | | | | | | | | | | | | |
| UL File No.E28476 (Recognized Component) | | Based on the requirements of application | Based on the requirements of application | — | — | Based on the requirements of application | — | | | | | | | | | | | | | | | | | | | | | | | | | | | | | | | | | | | | |
| CSA Report No. LR 7189 | | 600V AC/DC | <table border="1"> <thead> <tr> <th>AWG</th> <th>A</th> </tr> </thead> <tbody> <tr><td>16</td><td>13</td></tr> <tr><td>14</td><td>18</td></tr> <tr><td>12</td><td>25</td></tr> <tr><td>10</td><td>30</td></tr> </tbody> </table> | AWG | A | 16 | 13 | 14 | 18 | 12 | 25 | 10 | 30 | — | — | — | — | | | | | | | | | | | | | | | | | | | | | | | | | | |
| AWG | A | | | | | | | | | | | | | | | | | | | | | | | | | | | | | | | | | | | | | | | | | | |
| 16 | 13 | | | | | | | | | | | | | | | | | | | | | | | | | | | | | | | | | | | | | | | | | | |
| 14 | 18 | | | | | | | | | | | | | | | | | | | | | | | | | | | | | | | | | | | | | | | | | | |
| 12 | 25 | | | | | | | | | | | | | | | | | | | | | | | | | | | | | | | | | | | | | | | | | | |
| 10 | 30 | | | | | | | | | | | | | | | | | | | | | | | | | | | | | | | | | | | | | | | | | | |
| TÜV License No. R9650368 IP protection level IP-10 Overvoltage type (II) 50 cycles of repeated plugging and unplugging | | 600V AC/DC | <table border="1"> <thead> <tr> <th>AWG</th> <th>A</th> </tr> </thead> <tbody> <tr><td>16</td><td>15</td></tr> <tr><td>14</td><td>20</td></tr> <tr><td>12</td><td>25</td></tr> <tr><td>10</td><td>30</td></tr> </tbody> </table> | AWG | A | 16 | 15 | 14 | 20 | 12 | 25 | 10 | 30 | -30°C ~+105°C | — | <table border="1"> <thead> <tr> <th rowspan="2">AWG</th> <th colspan="2">A</th> </tr> <tr> <th>1-10P</th> <th>4-No of Pos.</th> </tr> </thead> <tbody> <tr><td>20</td><td>12.5</td><td>12.5</td></tr> <tr><td>18</td><td>17.5</td><td>16</td></tr> <tr><td>16</td><td>21</td><td>19.5</td></tr> <tr><td>14</td><td>26</td><td>24</td></tr> <tr><td>12</td><td>33</td><td>31</td></tr> <tr><td>10</td><td>40</td><td>37.5</td></tr> <tr><td>8</td><td>48</td><td>46</td></tr> </tbody> </table> | AWG | A | | 1-10P | 4-No of Pos. | 20 | 12.5 | 12.5 | 18 | 17.5 | 16 | 16 | 21 | 19.5 | 14 | 26 | 24 | 12 | 33 | 31 | 10 | 40 | 37.5 | 8 | 48 | 46 | -30°C ~+105°C |
| AWG | A | | | | | | | | | | | | | | | | | | | | | | | | | | | | | | | | | | | | | | | | | | |
| 16 | 15 | | | | | | | | | | | | | | | | | | | | | | | | | | | | | | | | | | | | | | | | | | |
| 14 | 20 | | | | | | | | | | | | | | | | | | | | | | | | | | | | | | | | | | | | | | | | | | |
| 12 | 25 | | | | | | | | | | | | | | | | | | | | | | | | | | | | | | | | | | | | | | | | | | |
| 10 | 30 | | | | | | | | | | | | | | | | | | | | | | | | | | | | | | | | | | | | | | | | | | |
| AWG | A | | | | | | | | | | | | | | | | | | | | | | | | | | | | | | | | | | | | | | | | | | |
| | 1-10P | 4-No of Pos. | | | | | | | | | | | | | | | | | | | | | | | | | | | | | | | | | | | | | | | | | |
| 20 | 12.5 | 12.5 | | | | | | | | | | | | | | | | | | | | | | | | | | | | | | | | | | | | | | | | | |
| 18 | 17.5 | 16 | | | | | | | | | | | | | | | | | | | | | | | | | | | | | | | | | | | | | | | | | |
| 16 | 21 | 19.5 | | | | | | | | | | | | | | | | | | | | | | | | | | | | | | | | | | | | | | | | | |
| 14 | 26 | 24 | | | | | | | | | | | | | | | | | | | | | | | | | | | | | | | | | | | | | | | | | |
| 12 | 33 | 31 | | | | | | | | | | | | | | | | | | | | | | | | | | | | | | | | | | | | | | | | | |
| 10 | 40 | 37.5 | | | | | | | | | | | | | | | | | | | | | | | | | | | | | | | | | | | | | | | | | |
| 8 | 48 | 46 | | | | | | | | | | | | | | | | | | | | | | | | | | | | | | | | | | | | | | | | | |

D-5000 Series Configurations

D-5200S

Single-row High Voltage Type

D-5200S Board-Mounting Header Vertical type (P.82)

D-5200S Free Hanging type (P.82)

D-5200S Tab Housing Panel type (P.82)

D-5200M α Board-Mounting Header Horizontal type (P.90)

D-5200S Receptacle Housing Panel type (P.82)

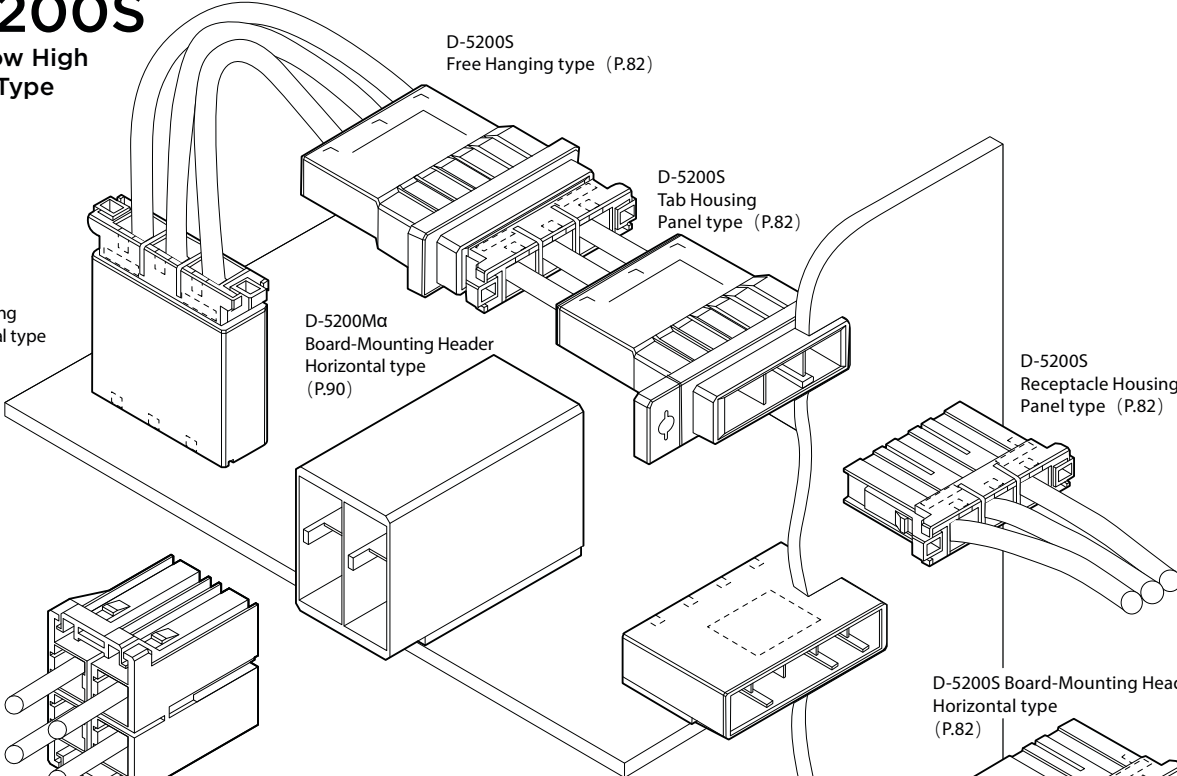

D-5200M α Receptacle Housing (P.90)

D-5200M α

High-current Modular Type

D-5200S Board-Mounting Header Horizontal type (P.82)

D-5200M

High-voltage Modular Type

D-5200M Board-Mounting Header Vertical type (P.84)

D-5200M Free Hanging type (P.84)

D-5200M Board-Mounting Header Horizontal type (P.84)

D-5200M Receptacle Housing Panel type (P.84)

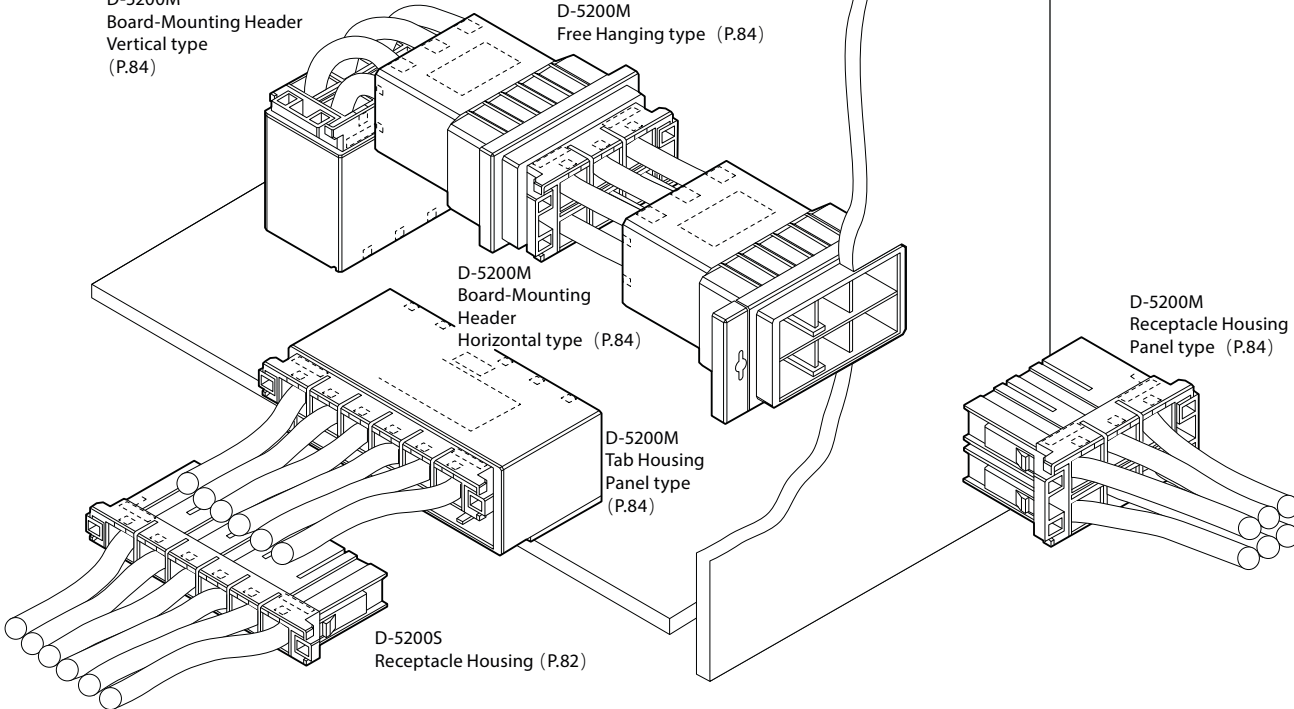

D-5200S Receptacle Housing (P.82)

D-5000 Series Contact

■ Crimped Types

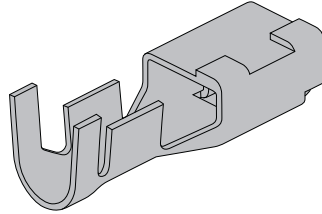

Receptacle Contact
(used in Receptacle
Housing)

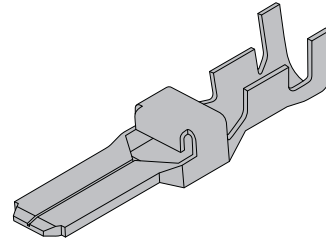

Tab contact
(used in Tab Housing)

•GoldPlating

Terminal

| Applicable Wire Range | | Outside Diameter of Insulation mm | Wire Range Mark | Contacts | | | | | | Applicable tools | | | |
|-----------------------|-----------------|-----------------------------------|-----------------|--------------------|-------------|-------------|-------------|--------------------------|-------------|-------------------|---------------------------|-----------|-----------------------|
| AWG | mm ² | | | Receptacle Contact | | Tab Contact | | Long sequential contacts | | Manual Hand Tools | Electric Hydraulic Tool※1 | Mold ※2 | Mini-Application Tool |
| | | | | Strip form | Loose Piece | Strip form | Loose Piece | Strip form | Loose Piece | | | | |
| 20 | 0.50 | 1.8-2.83 | SS | 1318985-□ | 1318986-□ | — | — | — | — | 91596-1 | — | — | ※1 |
| 16 | 1.25 | 2.35-3.23 | | 179955-□ | 316040-□ | 917802-□ | 917804-□ | 84696-1 | 2013594-1 | 234170-1 | — | 2155822-1 | 2266273-2 |
| 16 | 1.25 | 3-3.80 | S | 179956-□ | 316041-□ | 917803-□ | 917805-□ | 84695-1 | 2013593-1 | 234171-1 | 2155369-1 | 2155503-1 | 2151086-2 |
| 14 | 2.20 | | | 1318696-□ | 1318697-□ | 1981690-□ | 1981691-□ | 2174021-1 | 2174022-1 | 1366044-1 | — | 2155502-1 | 2266274-2 |
| 12 | 3.50 | 4-5.2 | M | 1318696-□ | 1318697-□ | 1981690-□ | 1981691-□ | 2174021-1 | 2174022-1 | 1366044-1 | — | 2155502-1 | 2266274-2 |
| 10 | 5.50 | | | 1318696-□ | 1318697-□ | 1981690-□ | 1981691-□ | 2174021-1 | 2174022-1 | 1366044-1 | — | 2155502-1 | 2266274-2 |
| 8 | 8.00 | 4.9-7.8 | L | 1318696-□ | 1318697-□ | 1981690-□ | 1981691-□ | 2174021-1 | 2174022-1 | 1366044-1 | — | 2155502-1 | 2266274-2 |

Note Plating code

- 2: Gold plating of 0.38 μm in thickness
- 6: Silver plating of 2.54 μm in thickness
- 3: Gold plating of 0.76 μm in thickness
- 1: Gold plating of 0.2 μm in thickness

Please contact the sales department for mini applications tools.

Strip Form contacts are used with Mini-applicators (bench machine) and Loose-Piece contacts are with hand tools.

For details, please contact the purchase agent or sales department.

※1 See P. 107.

If you have any questions, please contact the AT tooling sales department.

※2 Used together with the electric hydraulic tool 2155369-1

The receptacle contact can be used in all receptacle housings, the tab contact can be used in all tab housings. Details of the applicable tool are available from P. 107-111.

NOTE: all products are RoHS compliant On selection.

D-5200S Single-Row High Current Type

Type Chart

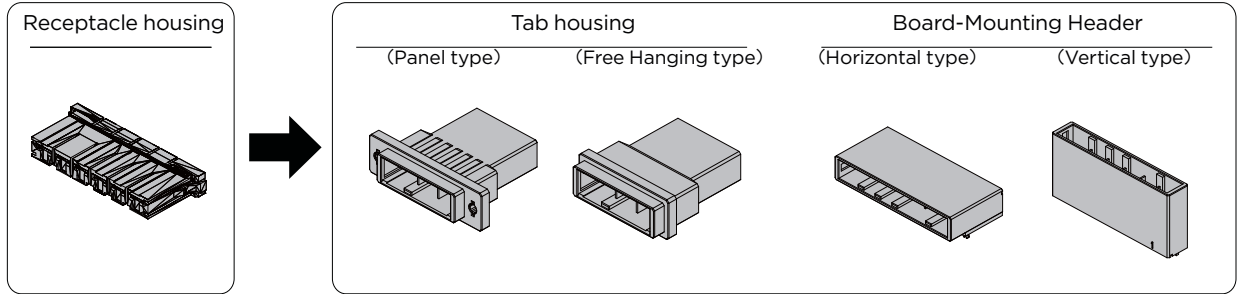

| Pos | Color | Key | Receptacle housing | Tab housing | | Plating | Board-Mounting Header | | | |
|-----|-------|-----|--------------------|--|-------------------|------------|-----------------------|------------|---------------|------------|
| | | | | Panel type | Free Hanging type | | Horizontal type | | Vertical type | |
| | | | | | | | Standard | Sequential | Standard | Sequential |
| 2 | Black | X | 1-179958-2 | 1-353047-2 | 1-353046-2 | Gold | 1-353079-2 | — | 1-353080-2 | — |
| | Gold | | | | | 1-353079-3 | — | 1-353080-3 | — | |
| | Gold | | | | | — | — | 6-353080-2 | — | |
| | Black | Y | 2-179958-2 | 2-353047-2 | 2-353046-2 | Gold | — | — | 2-353080-2 | — |
| | Gold | | | | | — | — | 2-353080-3 | — | |
| | Gold | | | | | — | — | — | — | |
| 3 | Black | X | 1-179958-3 | 1-353047-3 | 1-353046-3 | Gold | 1-353081-2 | 8-353081-2 | 1-353082-2 | 8-353082-2 |
| | Gold | | | | | 1-353081-3 | — | 1-353082-3 | — | |
| | Gold | | | | | — | — | — | — | |
| | Black | Y | 2-179958-3 | 2-353047-3 | 2-353046-3 | Gold | 2-353081-2 | — | 2-353082-2 | — |
| | Gold | | | | | 2-353081-3 | — | 2-353082-3 | — | |
| | Gold | | | | | — | — | — | — | |
| 4 | Black | X | 1-179958-4 | 4P or 6P Wire-to-wire connectors are available in D5200M, see P.84 | | Gold | 1-917541-2 | 8-917541-2 | 1-917542-2 | 8-917542-2 |
| | Gold | | | | | 1-917541-3 | — | 1-917542-3 | — | |
| | Black | Y | 2-179958-4 | | | Gold | 2-917541-2 | — | 2-917542-2 | — |
| | Gold | | | | | — | — | 2-917542-3 | — | |
| 6 | Black | X | 1-179958-6 | 4P or 6P Wire-to-wire connectors are available in D5200M, see P.84 | | Gold | 1-179959-2 | — | 1-179960-2 | — |
| | Gold | | | | | 1-179959-3 | — | 1-179960-3 | — | |
| | Gold | | | | | — | — | 6-179960-2 | — | |
| | Black | Y | 2-179958-6 | | | Gold | 2-179959-2 | — | 2-179960-2 | — |
| | Gold | | | | | 2-179959-3 | — | 2-179960-3 | — | |
| | Gold | | | | | — | — | 7-179960-2 | — | |

Relative Product Information

Applicable contact...P.81
 Performance & Specifications...P.79

Mated Dimension

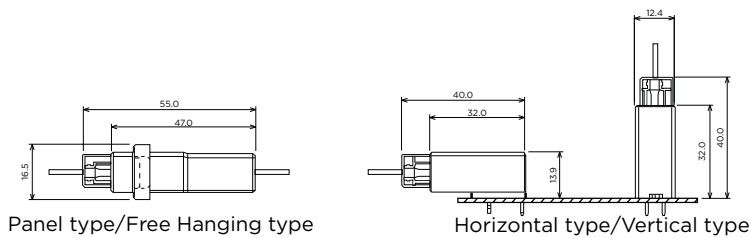

NOTE: all products are RoHS compliant On selection.

D-5200S Single-Row High Current Type

External Dimensions

■ Receptacle Housing

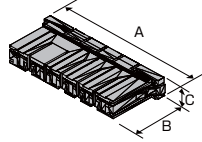

| Pos | Key | Color | Part Number | Dimensions | | |
|-----|-----|-------|-------------|------------|------|-----|
| | | | | A | B | C |
| 2 | X | Black | 1-179958-2 | 35.8 | 29.0 | 9.8 |
| | Y | Black | 2-179958-2 | | | |
| 3 | X | Black | 1-179958-3 | 46.0 | 29.0 | 9.8 |
| | Y | Black | 2-179958-3 | | | |
| 4 | X | Black | 1-179958-4 | 53.7 | 29.0 | 9.8 |
| | Y | Black | 2-179958-4 | | | |
| 6 | X | Black | 1-179958-6 | 74.0 | 29.0 | 9.8 |
| | Y | Black | 2-179958-6 | | | |

■ Tab Housing

Panel type

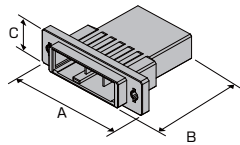

| Pos | Key | Color | Part Number | Dimensions | | |
|-----|-----|-------|-------------|------------|------|------|
| | | | | A | B | C |
| 2 | X | Black | 1-353047-2 | 47.0 | 47.0 | 16.5 |
| | Y | Black | 2-353047-2 | | | |
| 3 | X | Black | 1-353047-3 | 57.0 | 47.0 | 16.5 |
| | Y | Black | 2-353047-3 | | | |

Free Hanging type

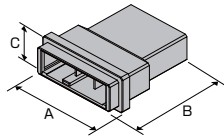

| Pos | Key | Color | Part Number | Dimensions | | |
|-----|-----|-------|-------------|------------|------|------|
| | | | | A | B | C |
| 2 | X | Black | 1-353046-2 | 33.4 | 47.0 | 16.5 |
| | Y | Black | 2-353046-2 | | | |
| 3 | X | Black | 1-353046-3 | 43.6 | 47.0 | 16.5 |
| | Y | Black | 2-353046-3 | | | |

NOTE: all products are RoHS compliant On selection.

■ Board-Mounting Header

Horizontal type

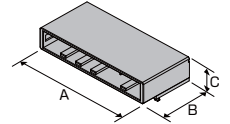

| Pos | Key | Plating | Color | Part Number | Dimensions | | |
|-----|-----|---------|-------|-------------|------------|------|------|
| | | | | | A | B | C |
| 2 | X | Gold | Black | 1-353079-2 | 29.4 | 32.0 | 13.9 |
| | | Gold | Black | 1-353079-3 | | | |
| 3 | X | Gold | Black | 1-353081-2 | 39.5 | 32.0 | 13.9 |
| | | Gold | Black | 8-353081-2※ | | | |
| | | Gold | Black | 1-353081-3 | | | |
| | Y | Gold | Black | 2-353081-2 | | | |
| 4 | X | Gold | Black | 1-917541-2 | 49.7 | 32.0 | 13.9 |
| | | Gold | Black | 8-917541-2※ | | | |
| | Y | Gold | Black | 1-917541-3 | | | |
| 6 | X | Gold | Black | 1-179959-2 | 70.0 | 32.0 | 13.9 |
| | | Gold | Black | 1-179959-3 | | | |
| | Y | Gold | Black | 2-179959-2 | | | |
| | Y | Gold | Black | 2-179959-3 | | | |

※Sequential

Vertical type

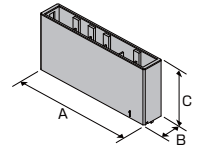

| Pos | Key | Plating | Color | Part Number | Dimensions | | |
|-----|-----|---------|-------|-------------|------------|------|------|
| | | | | | A | B | C |
| 2 | X | Gold | Black | 1-353080-2 | 29.4 | 12.4 | 32.0 |
| | | Gold | Black | 1-353080-3 | | | |
| | Y | Gold | Black | 6-353080-2 | | | |
| | | Gold | Black | 2-353080-2 | | | |
| 3 | X | Gold | Black | 1-353082-2 | 39.5 | 12.4 | 32.0 |
| | | Gold | Black | 8-353082-2※ | | | |
| | | Gold | Black | 1-353082-3 | | | |
| | Y | Gold | Black | 2-353082-2 | | | |
| 4 | X | Gold | Black | 1-917542-2 | 49.7 | 12.4 | 32.0 |
| | | Gold | Black | 8-917542-2※ | | | |
| | Y | Gold | Black | 1-917542-3 | | | |
| | | Gold | Black | 2-917542-2 | | | |
| 6 | X | Gold | Black | 1-179960-2 | 70.0 | 12.4 | 32.0 |
| | | Gold | Black | 1-179960-3 | | | |
| | | Gold | Black | 6-179960-2 | | | |
| | Y | Gold | Black | 2-179960-2 | | | |
| | | Gold | Black | 2-179960-3 | | | |
| | | Gold | Black | 7-179960-2 | | | |

※Sequential

D-5200M Double-row High Current Modular Type

Type Chart

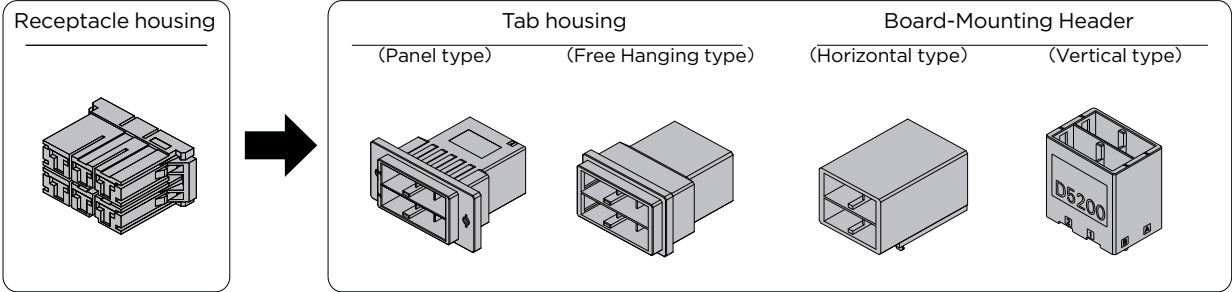

| Pos | Color | Key | Receptacle housing | Tab housing | | Plating | Board-Mounting Header | | | |
|-----|-------|-----|--------------------|-------------|-------------------|-------------|-----------------------|-------------|---------------|------------|
| | | | | Panel type | Free Hanging type | | Horizontal type | | Vertical type | |
| | | | | | | | Standard | Sequential | Standard | Sequential |
| 4 | Black | XX | 1-917807-2 | 1-917809-2 | 1-917808-2 | Gold/silver | 1-1123309-2 | 8-1123309-2 | 1-1981458-6 | — |
| | Black | YY | 2-917807-2 | 2-917809-2 | 2-917808-2 | Gold/silver | 2-1123309-2 | — | 2-1981458-6 | — |
| | Black | XY | 3-917807-2 | 3-917809-2 | 3-917808-2 | Gold/silver | 3-1123309-2 | — | 3-1981458-6 | — |
| 6 | Black | XX | 1-917807-3 | 1-917809-3 | 1-917808-3 | — | — | — | 1-2326092-2 | — |
| | Black | YY | 2-917807-3 | 2-917809-3 | 2-917808-3 | — | — | — | 2-2326092-2 | — |
| | Black | XY | 3-917807-3 | 3-917809-3 | 3-917808-3 | — | — | — | 3-2326092-2 | — |
| 8 | Black | XX | —※1 | — | — | Gold | 1123829-1 | — | — | — |
| | Black | YY | — | — | — | — | — | — | — | — |
| | Black | XY | — | — | — | — | — | — | — | — |

※1: Use two 1-179958-4

Relative Product Information

Applicable contact...P.81
 Performance & Specifications...P.79

Mated Dimension

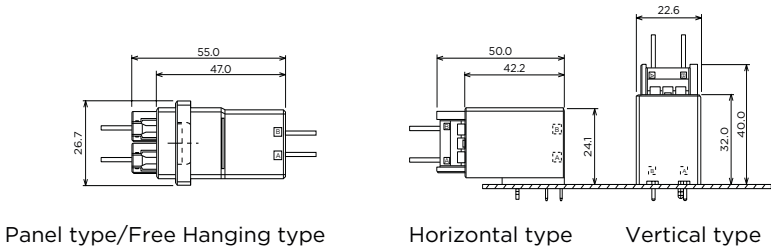

NOTE: all products are RoHS compliant On selection.

D-5200M Double-row High Current Modular Type

External Dimensions

■ Receptacle Housing

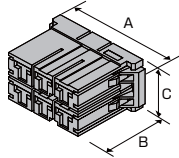

| Pos | Key | Color | Part Number | Dimensions | | |
|-----|-----|-------|-------------|------------|------|------|
| | | | | A | B | C |
| 4 | XX | Black | 1-917807-2 | 33.4 | 29.0 | 20.0 |
| | YY | Black | 2-917807-2 | | | |
| | XY | Black | 3-917807-2 | | | |
| 6 | XX | Black | 1-917807-3 | 43.5 | 29.0 | 20.0 |
| | YY | Black | 2-917807-3 | | | |
| | XY | Black | 3-917807-3 | | | |

■ Tab Housing

Panel type

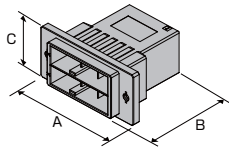

| Pos | Key | Color | Part Number | Dimensions | | |
|-----|-----|-------|-------------|------------|------|------|
| | | | | A | B | C |
| 4 | XX | Black | 1-917809-2 | 47.0 | 47.0 | 26.7 |
| | YY | Black | 2-917809-2 | | | |
| | XY | Black | 3-917809-2 | | | |
| 6 | XX | Black | 1-917809-3 | 57.0 | 47.0 | 26.7 |
| | YY | Black | 2-917809-3 | | | |
| | XY | Black | 3-917809-3 | | | |

Free Hanging type

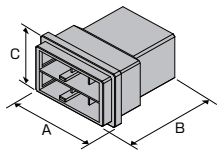

| Pos | Key | Color | Part Number | Dimensions | | |
|-----|-----|-------|-------------|------------|------|------|
| | | | | A | B | C |
| 4 | XX | Black | 1-917808-2 | 33.4 | 47.0 | 26.7 |
| | YY | Black | 2-917808-2 | | | |
| | XY | Black | 3-917808-2 | | | |
| 6 | XX | Black | 1-917808-3 | 43.6 | 47.0 | 26.7 |
| | YY | Black | 2-917808-3 | | | |
| | XY | Black | 3-917808-3 | | | |

NOTE: all products are RoHS compliant On selection.

■ Board-Mounting Header

Horizontal type

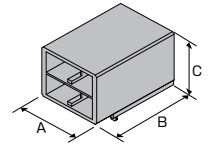

| Pos | Key | Plating | Color | Part Number | Dimensions | | |
|-----|-----|---------|-------|-------------|------------|------|------|
| | | | | | A | B | C |
| 4 | XX | Gold | Black | 1-1123309-2 | 29.4 | 42.2 | 24.1 |
| | YY | Gold | Black | 2-1123309-2 | | | |
| | XY | Gold | Black | 3-1123309-2 | | | |
| 8 | XX | Gold | Black | 1123829-1 | 49.7 | 32.0 | 26.3 |

Sequential type

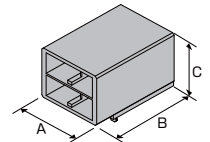

| Pos | Key | Plating | Color | Part Number | Dimensions | | |
|-----|-----|---------|-------|-------------|------------|------|------|
| | | | | | A | B | C |
| 4 | XX | Gold | Black | 8-1123309-2 | 29.4 | 42.2 | 24.1 |

Vertical type

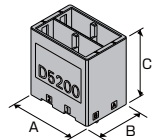

| Pos | Key | Plating | Color | Part Number | Dimensions | | |
|-----|-----|---------|-------|-------------|------------|------|------|
| | | | | | A | B | C |
| 4 | XX | Silver | Black | 1-1981458-6 | 29.4 | 22.6 | 32.0 |
| | YY | Silver | Black | 2-1981458-6 | | | |
| | XY | Silver | Black | 3-1981458-6 | | | |
| 6 | XX | Gold | Black | 1-2326092-2 | 39.5 | 22.6 | 32 |
| | YY | Gold | Black | 2-2326092-2 | | | |
| | XY | Gold | Black | 3-2326092-2 | | | |

D-5300 Reversed Mounting Type

Type Chart

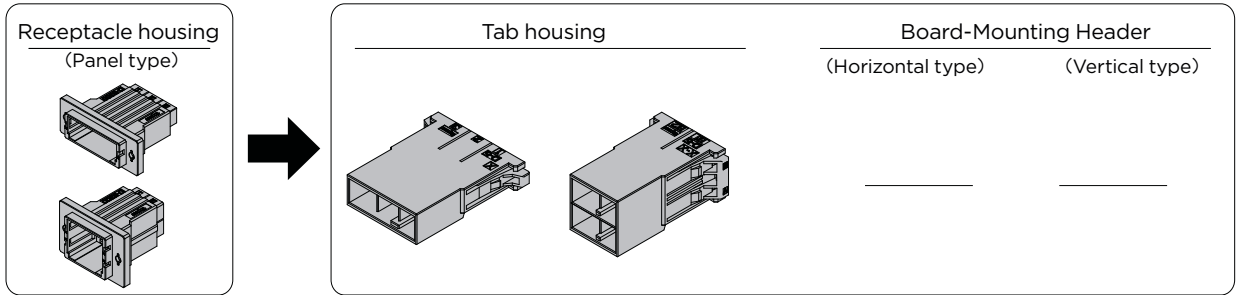

| Pos | Color | Key | Receptacle housing | Tab housing | Plating | Board-Mounting Header | |
|-----|-------|-----|--------------------|-------------|---------|-----------------------|---------------|
| | | | Panel type | | | Horizontal type | Vertical type |
| 3 | Black | X | 1-1747821-3 | 1-1747819-3 | — | — | — |
| | Black | Y | 2-1747821-3 | 2-1747819-3 | — | — | — |
| 4 | Black | XX | 1-1747822-2 | 1-1747820-2 | — | — | — |
| | Black | YY | 2-1747822-2 | 2-1747820-2 | — | — | — |
| | Black | XY | 3-1747822-2 | 3-1747820-2 | — | — | — |

Relative Product Information

Applicable contact...P.81

Performance & Specifications...P.79

Mated Dimension

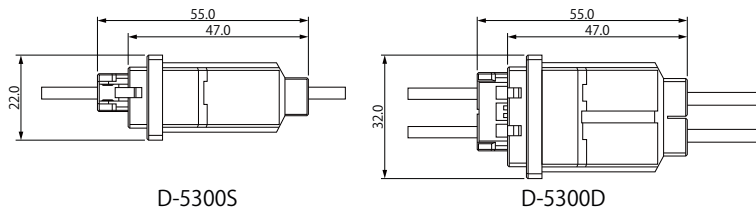

External Dimensions

Receptacle Housing

Panel Mount Type

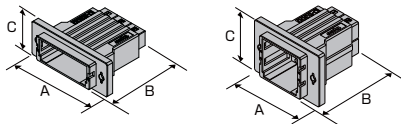

| Pos | Key | Color | Part Number | Dimensions | | |
|-----|-----|-------|-------------|------------|------|------|
| | | | | A | B | C |
| 3 | X | Black | 1-1747821-3 | 57.0 | 47.0 | 22.0 |
| | Y | Black | 2-1747821-3 | | | |
| 4 | XX | Black | 1-1747822-2 | 47.0 | 47.0 | 32.0 |
| | YY | Black | 2-1747822-2 | | | |
| | XY | Black | 3-1747822-2 | | | |

NOTE: all products are RoHS compliant On selection.

Tab Housing

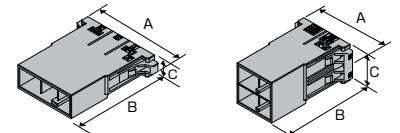

| Pos | Key | Color | Part Number | Dimensions | | |
|-----|-----|-------|-------------|------------|------|------|
| | | | | A | B | C |
| 3 | X | Black | 1-1747819-3 | 46.5 | 47.0 | 12.5 |
| | Y | Black | 2-1747819-3 | | | |
| 4 | XX | Black | 1-1747820-2 | 33.8 | 47.0 | 22.6 |
| | YY | Black | 2-1747820-2 | | | |
| | XY | Black | 3-1747820-2 | | | |

D-5200 Dyna-Tap 12P(4Px3 Row), 20P(4Px5 Row)

Type Chart

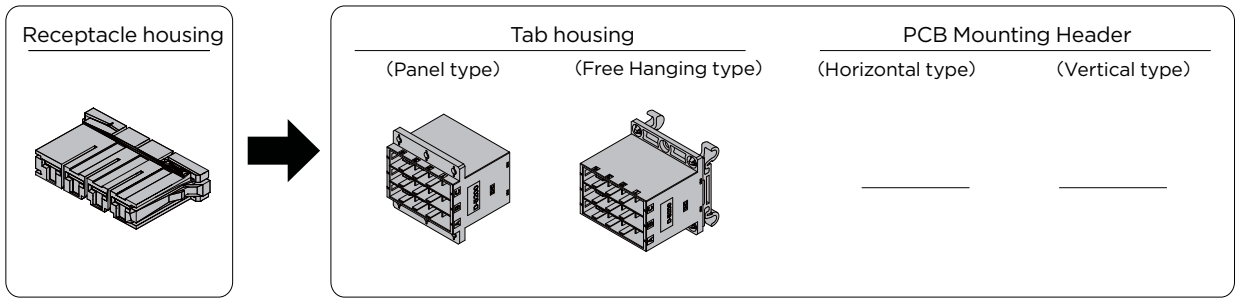

| Pos | Color | Key | Receptacle housing | Tab housing | | Plating | Board-Mounting Header | |
|-----|-------|-----|--------------------|-------------|----------------|---------|-----------------------|---------------|
| | | | | Panel type | DIN guide rail | | Horizontal type | Vertical type |
| 4 | Black | — | 1-179958-4 | — | — | — | — | — |
| 12 | Black | — | — | 1903146-1※1 | 1903146-3 | Gold | — | — |
| 12 | Black | — | — | 1903146-2※2 | 1-1903146-3 | Gold | — | — |
| 20 | Black | — | — | 2013285-1※1 | — | Gold | — | — |
| | Black | — | — | 2013285-2※2 | 2013285-3 | Gold | — | — |

※1:Front panel type ※2:Bottom panel type

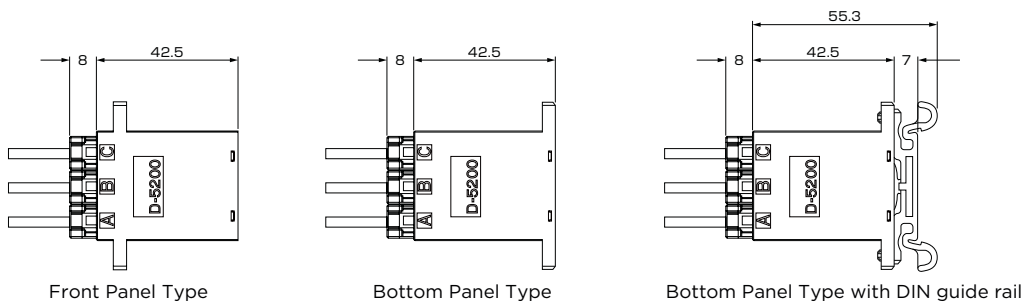

External Dimensions

■ Receptacle Housing

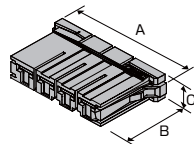

| Pos | Key | Color | Part Number | Dimensions | | |
|-----|-----|-------|-------------|------------|------|-----|
| | | | | A | B | C |
| 4 | — | Black | 1-179958-4 | 53.7 | 29.0 | 9.8 |

■ Tab Housing

Panel type

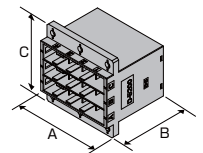
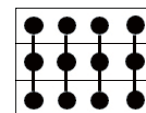

| Pos | Key | Plating | Color | Part Number | Dimensions | | |
|-----|-----|---------|-------|-------------|------------|------|------|
| | | | | | A | B | C |
| 12 | — | Gold | Black | 1903146-1 | 49.7 | 42.5 | 50.0 |
| | — | Gold | Black | 1903146-2 | | | |
| 20 | — | Gold | Black | 2013285-1 | 50.5 | 42.5 | 76.4 |
| | — | Gold | Black | 2013285-2 | | | |

DIN-rail type

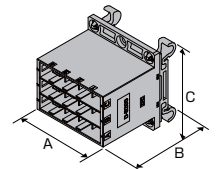

| Pos | Key | Plating | Color | Part Number | Dimensions | | |
|-----|-----|---------|-------|-------------|------------|------|------|
| | | | | | A | B | C |
| 12 | — | Gold | Black | 1903146-3 | 49.7 | 55.3 | 50.0 |
| | — | Gold | Black | 1-1903146-3 | | | |
| 20 | — | Gold | Black | 2013285-3 | 53.0 | 55.3 | 76.4 |

NOTE: all products are RoHS compliant On selection.

Dyna-Clamp Kit/ Cable Clamp Kit

Type Chart

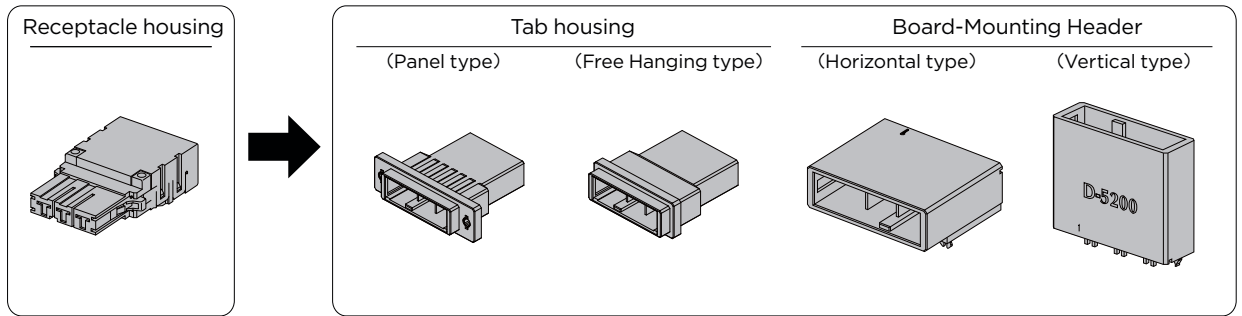

| Pos | Key | Receptacle housing | Tab housing | | Board-Mounting Header | |
|-----|-----|--------------------|-------------|-------------------|--------------------------|--------------------------|
| | | | Panel type | Free Hanging type | Horizontal type | Vertical type |
| 3 | — | 1473668-1* | 1-353047-3 | 1-353046-3 | 1-353081-2 1-353081-3 | 1-353082-2 1-353082-3 |
| 4 | XX | 1971239-1 | 1-917809-2 | 1-917808-2 | 1-1123309-2 | 1-1981458-6※ |
| | YY | 1971239-2 | 2-917809-2 | 2-917808-2 | 2-1123309-2 | 2-1981458-6※ |

※Silver-plated products
*Sequential type

Mated Dimension

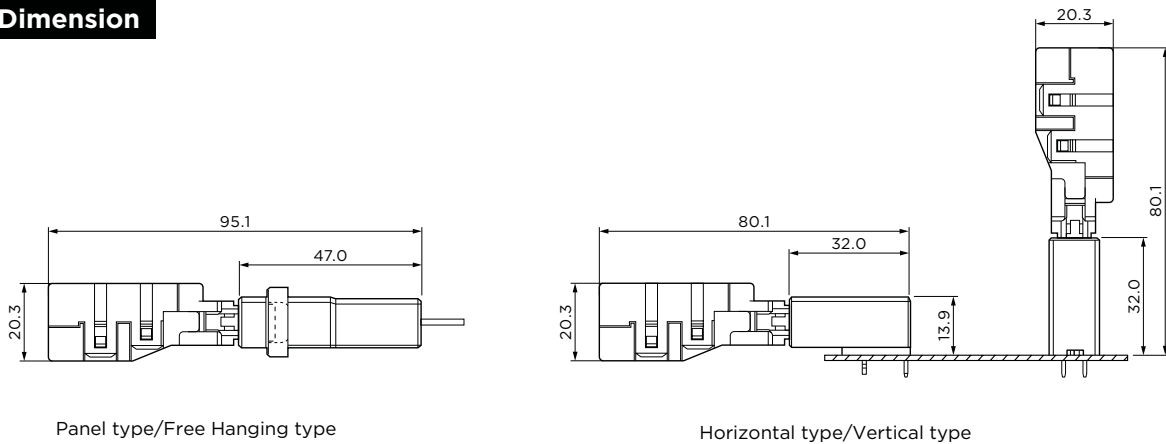

External Dimensions

Receptacle Housing

Single-row

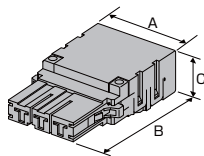

Double-row

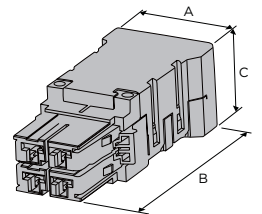

| Pos | Key | Color | Part Number | Dimensions | | |
|-----|-----|-------|-------------|------------|------|------|
| | | | | A | B | C |
| 3 | — | Black | 1473668-1 | 40.3 | 69.3 | 20.3 |

| Pos | Key | Color | Part Number | Dimensions | | |
|-----|-----|-------|-------------|------------|------|------|
| | | | | A | B | C |
| 4 | XX | Black | 1971239-1 | 36.0 | 81.2 | 29.0 |
| | YY | | 1971239-2 | | | |

NOTE: all products are RoHS compliant On selection.

Dyna-Clamp Kit /Cable Clamp Kit

■ Tab Housing

Panel type

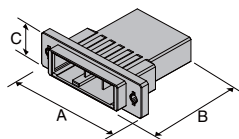

| Pos | Key | Color | Part Number | Dimensions | | |
|-----|-----|-------|-------------|------------|------|------|
| | | | | A | B | C |
| 3 | X | Black | 1-353047-3 | 57.0 | 47.0 | 12.1 |
| 4 | XX | Black | 1-917809-2 | 47.0 | 47.0 | 26.7 |
| | YY | Black | 2-917809-2 | | | |

Free Hanging type

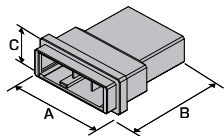

| Pos | Key | Color | Part Number | Dimensions | | |
|-----|-----|-------|-------------|------------|------|------|
| | | | | A | B | C |
| 3 | X | Black | 1-353046-3 | 43.6 | 47.0 | 12.1 |
| 4 | XX | Black | 1-917808-2 | 33.4 | 47.0 | 26.7 |
| | YY | Black | 2-917808-2 | | | |

NOTE: all products are RoHS compliant On selection.

■ Board-Mounting Header

Horizontal type

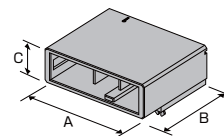

| Pos | Key | Plating | Color | Part Number | Dimensions | | |
|-----|-----|---------|-------|-------------|------------|------|------|
| | | | | | A | B | C |
| 3 | X | Gold | Black | 1-353081-2 | 39.5 | 32.0 | 13.9 |
| | | Gold | Black | 1-353081-3 | | | |
| 4 | XX | Gold | Black | 1-1123309-2 | 29.4 | 42.2 | 24.1 |
| | | YY | Gold | Black | | | |

Vertical type

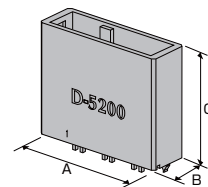

| Pos | Key | Plating | Color | Part Number | Dimensions | | |
|-----|-----|---------|--------|-------------|------------|------|------|
| | | | | | A | B | C |
| 3 | X | Gold | Black | 1-353082-2 | 39.5 | 12.4 | 32.0 |
| | | Gold | Black | 1-353082-3 | | | |
| 4 | XX | Silver | Black | 1-1981458-6 | 29.4 | 22.6 | 32.0 |
| | | YY | Silver | Black | | | |

D-5000 α Series Contact

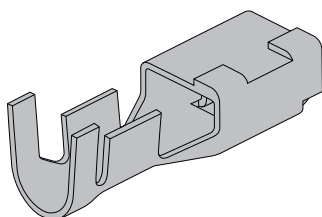

• D-5 α Series silver-plated type

| Wire Range | | Outside Diameter of Insulation mm | Wire Range Mark | Contacts | | | Applicable tools | | | |
|------------|-----------------|-----------------------------------|-----------------|--------------------|-------------|-------------|------------------|------------------------------------|-----------------------------------|--|
| AWG | mm ² | | | Receptacle Contact | | Tab Contact | Hand Tools | Electric Hydraulic Tool \times 5 | Dice \times 6 | Tool numbers |
| | | | | Strip form | Loose Piece | Loose Piece | | | | |
| 20 | 0.50 | 1.8-2.83 | SS | 1318985-6 | 1318986-6 | — | 91596-1 | — | — | 1366757-2 1528106-2 |
| 16 | 1.25 | 2.35-3.23 | | | | | | | | |
| 16 | 1.25 | 3-3.80 | S | 179955-6 | 316040-6 | 917804-6 | 234170-1 | 2155369-1 | 2155822-1 | 1366659-2 1426229-2 \times 1 |
| 14 | 2.20 | | | | | | | | | |
| 12 | 3.50 | 4-5.2 | M | 179956-6 | 316041-6 | 917805-6 | 234171-1 | 2155369-1 | 2155503-1 | 1366660-2 \times 2 2151086-2 \times 3 |
| 10 | 5.50 | | | | | | | | | |
| 8 | 8.00 | 4.9-7.8 | L | 1318696-6 | 1318697-6 | 1747443-6 | 1366044-1 | 2155502-1 | 1366658-3 1426325-2 \times 4 | |

Note: The model with its name including “-6” has a silver plating of 2.54 μ m in thickness.

For details, please contact the purchase agent or sales department.

Please contact the sales department for mini application tools.

Strip Form contacts are used with Mini-applicators (bench machine) and Loose-Piece contacts are with hand tools.

- \times 1 Applicable contact:179955-□
- \times 2 Applicable contact:179956-□ 917803-□ 84695-□
- \times 3 Applicable contact:179956-□ 917803-□
- \times 4 Applicable contact:1318696-□

\times 5 See P. 107

If you have any questions, please contact the AT tooling sales department.

\times 6 Used together with the electric hydraulic tool 2155369-1

The Receptacle contacts can be used for all receptacle housings.

NOTE: all products are RoHS compliant On selection.

D-5200Mα Double-row High Current/Voltage Modular Type

Type Chart

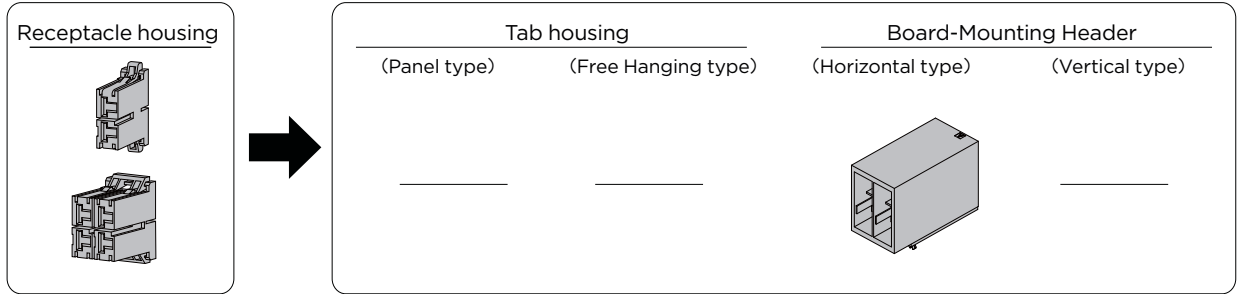

| Pos | Color | Key | Receptacle housing | Tab housing | | Plating | Board-Mounting Header | |
|-----|-------|-----|--------------------|-------------|-------------------|---------|-----------------------|---------------|
| | | | | Panel type | Free Hanging type | | Horizontal type | Vertical type |
| 2 | Black | X | 1-179958-2 | — | — | — | — | — |
| | Black | Y | 2-179958-2 | — | — | — | — | — |
| 4 | Black | XX | 1-917807-2 | — | — | Silver | 1-1318983-6 | — |
| | Black | YY | 2-917807-2 | — | — | Silver | 2-1318983-6 | — |
| | Black | XY | 3-917807-2 | — | — | Silver | 3-1318983-6 | — |

Note: Receptacle housing 2-pole D-5200S and 4-pole D-5200M are the same product
However, contact used is D-5a (silver plating • type)

Relative Product Information

Applicable contact...P.90
Performance & Specifications...P.79

Mated Dimension

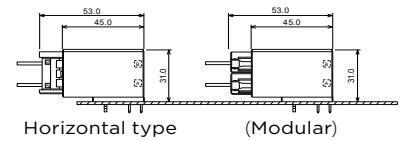

External Dimensions

Receptacle Housing

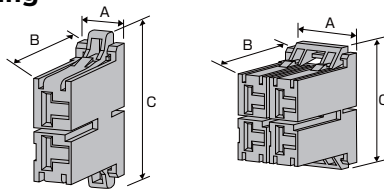

| Pos | Key | Plating | Color | Part Number | Dimensions | | |
|-----|-----|---------|-------|-------------|------------|------|------|
| | | | | | A | B | C |
| 2 | X | — | Black | 1-179958-2 | 9.8 | 29.0 | 23.8 |
| | Y | — | Black | 2-179958-2 | | | |
| 4 | XX | — | Black | 1-917807-2 | 20.0 | 29.0 | 33.4 |
| | YY | — | Black | 2-917807-2 | | | |
| | XY | — | Black | 3-917807-2 | | | |

Board-Mounting Header

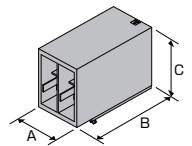

| Pos | Key | Plating | Color | Part Number | Dimensions | | |
|-----|-----|---------|-------|-------------|------------|------|------|
| | | | | | A | B | C |
| 4 | XX | Silver | Black | 1-1318983-6 | 22.6 | 45.0 | 30.9 |
| | YY | Silver | Black | 2-1318983-6 | | | |
| | XY | Silver | Black | 3-1318983-6 | | | |

NOTE: all products are RoHS compliant On selection.

DZ-5200

Useful for enabling cableless control board. High-current board to board connectors with 30A per contact.

- Equipped with retention leg to protect board from load
- Space allocated to prevent twisting the contact
- Circuit numbers are easy to identify even for board connectors
- Keying function included for flexibility when using multiple units
- Soldering without masking

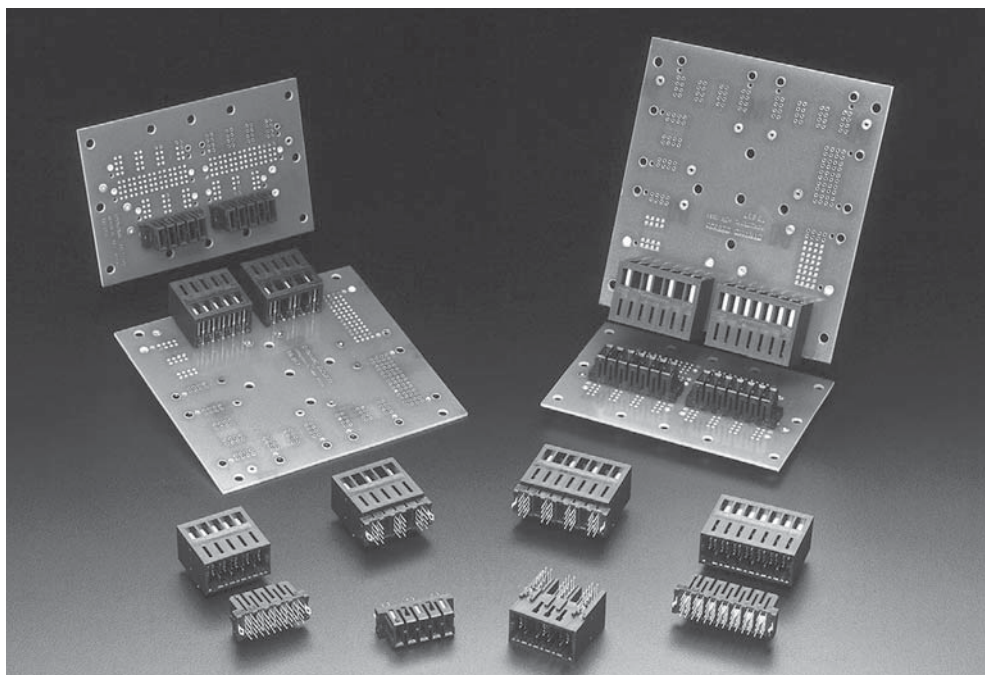

Performance Specifications

| Item | Pitch | 200 mils/400 mils 5.08mm/10.16mm |
|------------------------|-------|---|
| Rated Voltage | | 5.08mm Pitch:250V AC(rms)/DC 10.16mm Pitch:600V AC(rms)/DC |
| Rated Current | | 5.08mm Pitch:20A 10.16mmPitch:30A |
| Contact resistance | | 2mΩ Max |
| Withstanding Voltage | | 5.08mm Pitch:2,200V AC 1 min 10.16mm Pitch:4,000V AC 1 min |
| Temperature | | -55-+105°C |
| Product Specifications | | 108-78186 |

Materials and Plating

| Category | Materials | Plating |
|--------------------|--|---|
| Receptacle Contact | Phosphor bronze Copper alloys | Gold Plating with Nickel under-plated |
| Tab Contact | Phosphor bronze Copper alloys | Tin, Gold Plating with Nickel under-plated |
| Housing | UL9 4V-0, thermoplastic PBT with glass fiber | |

DZ-5200

Type Chart

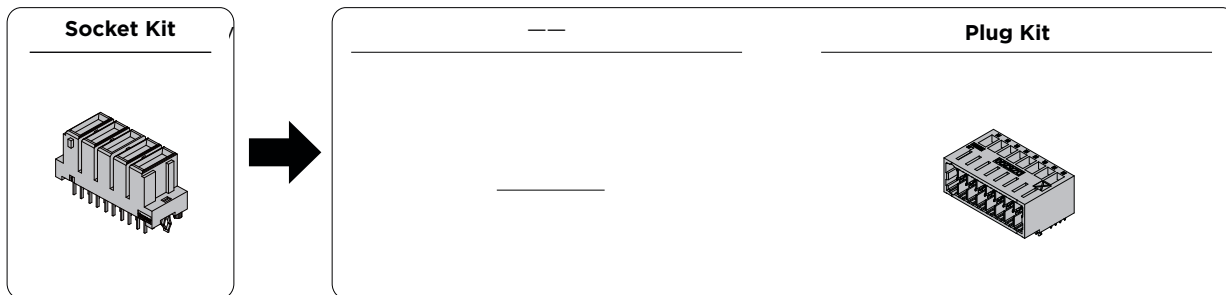

| Pos | Color | Key | Socket Kit | Plating | --- | Plug Kit |
|-----|-------|-----|-------------|---------|-----|-------------|
| 3 | Black | — | 5-1747147-3 | Gold | --- | 5-1747145-3 |
| 4 | Black | — | 5-1747147-4 | Gold | --- | 5-1747145-4 |
| 5 | Black | — | 1-1747147-5 | Gold | --- | 1-1747145-5 |
| 7 | Black | — | 1-1747147-7 | Gold | --- | 1-1747145-7 |

External Dimensions

Socket Kit

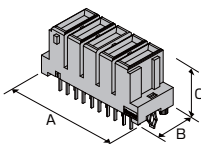

| Pos | Key | Plating | Color | Part Number | Dimensions | | |
|-----|-----|---------|-------|-------------|------------|------|------|
| | | | | | A | B | C |
| 3 | — | Gold | Black | 5-1747147-3 | 30.8 | 11.5 | 14.0 |
| 4 | — | Gold | Black | 5-1747147-4 | 40.9 | 11.5 | 14.0 |
| 5 | — | Gold | Black | 1-1747147-5 | 30.8 | 11.5 | 14.0 |
| 7 | — | Gold | Black | 1-1747147-7 | 40.9 | 11.5 | 14.0 |

Plug Kit

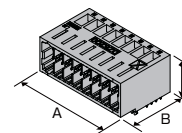

| Pos | Key | Plating | Color | Part Number | Dimensions | | |
|-----|-----|---------|-------|-------------|------------|------|------|
| | | | | | A | B | C |
| 3 | — | Gold | Black | 5-1747145-3 | 28.8 | 27.0 | 17.5 |
| 4 | — | Gold | Black | 5-1747145-4 | 39.0 | 27.0 | 17.5 |
| 5 | — | Gold | Black | 1-1747145-5 | 28.8 | 27.0 | 17.5 |
| 7 | — | Gold | Black | 1-1747145-7 | 39.0 | 27.0 | 17.5 |

NOTE: all products are RoHS compliant On selection.

Multi-Frame connector (MF Series)

The Multi-Frame connector is formed by accommodating the modular housing of the Dynamic connector in a resin frame, which could enable plugged and unplugged together. The modular housing of the existing D-2800, 3800, 4800 or 5800 series can be accommodated by the frame freely.

In addition, it is locked by an independently-developed locking mechanism automatically when plug, and can be unplugged easily with fingertips. The burden on the operator is reduced.

With this frame, a lot of work in assembly and maintenance can be saved, and incorrect operations such as incorrect wiring, etc. can be avoided.

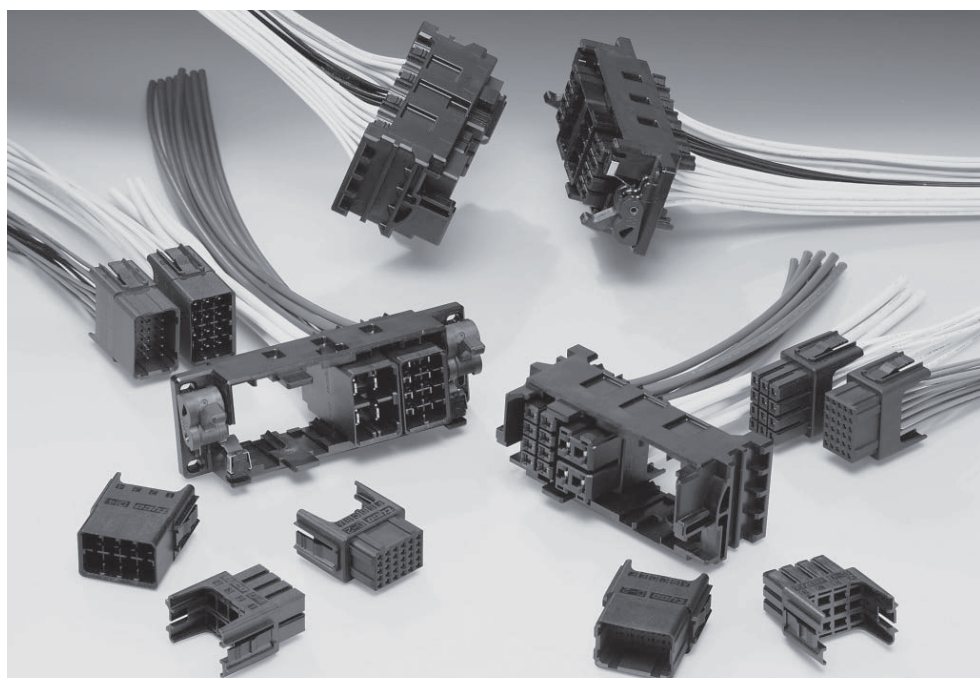

Main Performance

| Item \ Series | D-2800 | D-3800 | D-4800 | D-5800 |
|-----------------------------|-----------------------------|-----------------------------|-----------------------------|----------------------------|
| Rated Voltage | AC/DC 250V | AC/DC 600V | AC/DC 600V | AC/DC 630V |
| Rated Current | 5A | 15A | 25A | 40A |
| | When an AWG#18 wire is used | When an AWG#16 wire is used | When an AWG#12 wire is used | When an AWG#8 wire is used |
| Contact resistance | Maximum: 10mΩ | | | Maximum: 2mΩ |
| Withstanding Voltage | 1,500VAC(1 min) | | 2,500VAC(1 min) | 3,000VAC(1 min) |
| Operating Temperature | -55~+105°C | | | |
| Product Specifications | 108-78284 | 108-78285 | 108-78388 | 108-78389 |
| Applications Specifications | 114-5258 | 114-5148 | 114-5369 | 114-5206 |

Materials and Plating

| Category | Materials | Plating |
|-----------------------------------|--|---------------------------------------|
| Receptacle Contact Tab housing | Phosphor bronze or copper alloy | Gold Plating with Nickel under-plated |
| Housing | UL94V-0, reinforced thermoplastic with glass fiber | |

Contact

The D-2, D-3, D-4 and D-5 contacts of the Dynamic series can be directly used. (The existing tools can also be used as special tools and application tools)

See P. 29 for the D-2 terminal.

See P. 74 for the D-4 terminal.

See P. 39 for the D-3 terminal.

See P. 81 for the D-5 terminal.

Multi-Frame Connector

Product Features

- The modular structure can accommodate Dynamic series housings
- Panel mount
- Quick locking
- Easy unlocking by pressing the latches
- A key for preventing mis-plugging
- Easy operation

Applications

- Semiconductor and liquid crystal production equipment
- Large control equipment and machine tools
- Other

Product Specifications

Product standard number 108-78644

Performance Specification

| Item | STD. |
|---------------------|----------------------------|
| Frame Lock Strength | Pull force: Minimum: 15kgf |
| Durability | Maximum: 50 cycles |

Mated Dimension

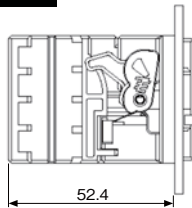

External Dimensions

■ Cable Side Frame

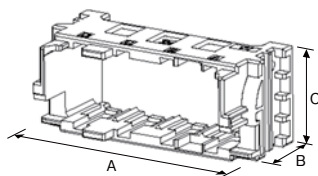

| Key | Part Number | Dimensions(mm) | | |
|-----|-------------|----------------|------|------|
| | | A | B | C |
| Z | 2069524-4 | 97.1 | 45.1 | 40.4 |
| Y | 2069524-3 | | | |
| X | 2069524-2 | | | |
| W | 2069524-1 | | | |

■ Panel Side Frame

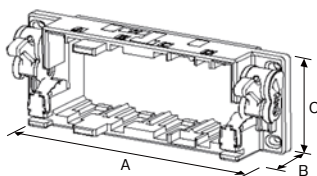

| Key | Part Number | Dimensions(mm) | | |
|-----|-------------|----------------|------|------|
| | | A | B | C |
| Z | 2069526-4 | 120.0 | 34.3 | 40.4 |
| Y | 2069526-3 | | | |
| X | 2069526-2 | | | |
| W | 2069526-1 | | | |

Dynamic Multi-Frame (MF) Module

Type Chart

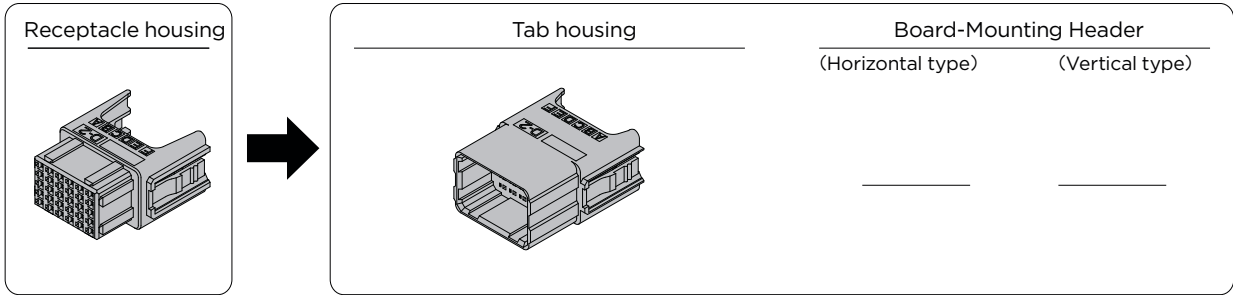

| Pos | Color | Key | Receptacle housing | Tab housing | Plating | Board-Mounting Header | |
|-----|-------|-----|--------------------|-------------|---------|-----------------------|---------------|
| | | | | | | Horizontal type | Vertical type |
| 30 | Black | — | 1747365-1 | 1747366-1 | — | — | — |
| 12 | Black | — | 1747363-1 | 1747364-1 | — | — | — |
| 8 | Black | — | 1871416-1 | 1871417-1 | — | — | — |
| 4 | Black | — | 1871418-1 | 1871419-1 | — | — | — |

D-2800 Pitch: 3.75mm

External Dimensions

■ Receptacle Housing

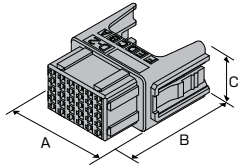

| Pos | Key | Color | Part Number | Dimensions | | |
|-----|-----|-------|-------------|------------|------|------|
| | | | | A | B | C |
| 30 | — | Black | 1747365-1 | 30.3 | 37.6 | 19.5 |

■ Tab Housing

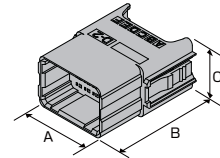

| Pos | Key | Color | Part Number | Dimensions | | |
|-----|-----|-------|-------------|------------|------|------|
| | | | | A | B | C |
| 30 | — | Black | 1747366-1 | 30.3 | 40.0 | 19.5 |

NOTE: all products are RoHS compliant On selection.

Dynamic Multi-Frame (MF) Module

D-3800 pitch: 6.5mm

External Dimensions

■ Receptacle Housing

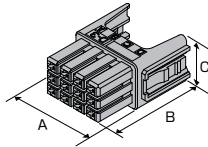

| Pos | Key | Color | Part Number | Dimensions | | |
|-----|-----|-------|-------------|------------|------|------|
| | | | | A | B | C |
| 12 | — | Black | 1747363-1 | 30.3 | 41.4 | 19.5 |

■ Tab Housing

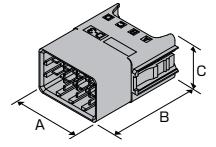

| Pos | Key | Color | Part Number | Dimensions | | |
|-----|-----|-------|-------------|------------|------|------|
| | | | | A | B | C |
| 12 | — | Black | 1747364-1 | 30.3 | 40.0 | 19.5 |

D-4800 pitch: 6.35mm

External Dimensions

■ Receptacle Housing

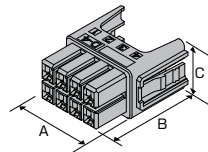

| Pos | Key | Color | Part Number | Dimensions | | |
|-----|-----|-------|-------------|------------|------|------|
| | | | | A | B | C |
| 8 | — | Black | 1871416-1 | 30.3 | 38.6 | 19.5 |

■ Tab Housing

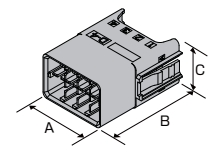

| Pos | Key | Color | Part Number | Dimensions | | |
|-----|-----|-------|-------------|------------|------|------|
| | | | | A | B | C |
| 8 | — | Black | 1871417-1 | 30.3 | 40.0 | 19.5 |

D-5800 pitch: 12.0mm

External Dimensions

■ Receptacle Housing

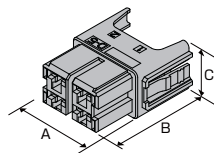

| Pos | Key | Color | Part Number | Dimensions | | |
|-----|-----|-------|-------------|------------|------|------|
| | | | | A | B | C |
| 4 | — | Black | 1871418-1 | 30.3 | 41.4 | 19.5 |

■ Tab Housing

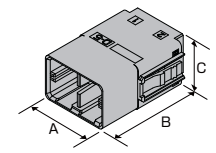

| Pos | Key | Color | Part Number | Dimensions | | |
|-----|-----|-------|-------------|------------|------|------|
| | | | | A | B | C |
| 4 | — | Black | 1871419-1 | 30.3 | 44.1 | 19.5 |

NOTE: all products are RoHS compliant On selection.

D-7000 Series

Series introduction

Dynamic D7000 series includes the highest power rated connector that is max 65A (per contact, using max. wire size)

It is available in board to wire, wire to wire, wire to panel -some are finger safe (Reverse Mount Type) - and long pin types all providing stable electrical connections for semiconductor manufacturing machines, construction plant etc. The number of positions is the industry standard 4P, which will meet a wide range of application requirements.

The receptacle contact is the 'crown banct' type containing a tube shape spring, meaning high performance and operation feasibility.

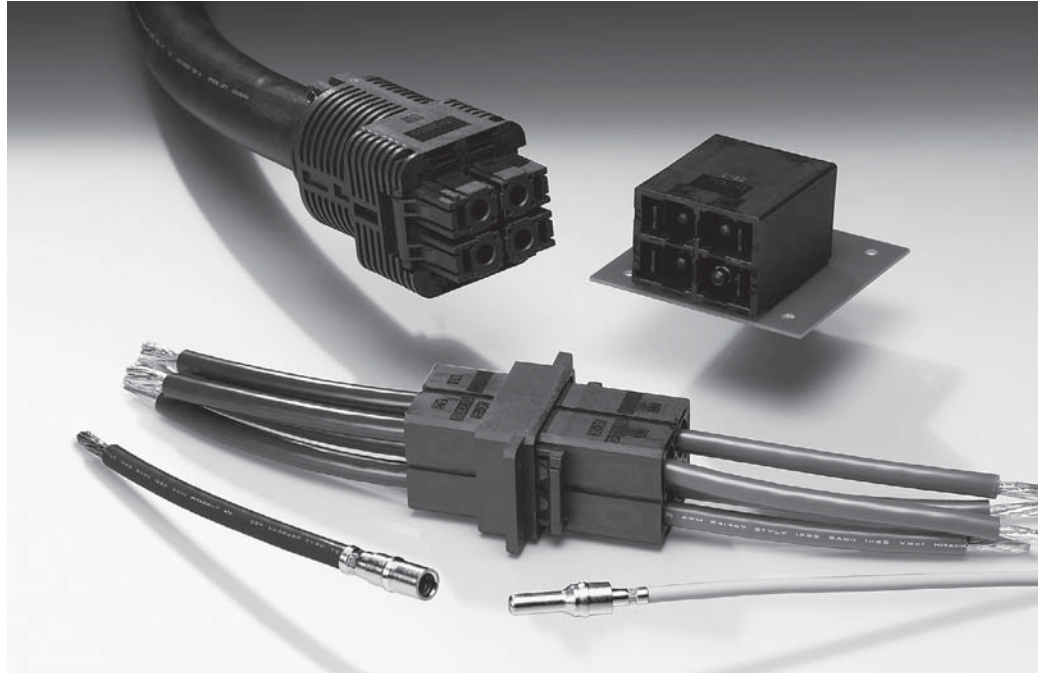

Product Features

1. Achieved High Current and High Reliability up to 65A

To accommodate the high current of 65A, we adopted, for the first time, a crown band with a multi-point contact mechanism in the receptacle contact. This contact is not only highly reliable, but disperses the heat generated when high current passes through the contact.

2. Sequential Connection

Sequential connection is compatible 2 types of pin contact are available, standard type and long type. This is ideal for applications when sequential connections from the crown pin are required.

3. Other

- Standard type and reverse type are available, offering a wide variety of mating options
- By using cable clamp type applicable to jacket cable, it can be used as an I/O connector

D-7000 Series Performance and Specifications

Performance

| Item | |
|------------------------------|---------------------------------|
| Pitch | 16mm |
| Rated Current | Maximum: 65A |
| Rated Voltage | 630V AC / DC |
| Dielectric Withstand Voltage | 3000 VAC |
| Total resistance | Maximum: 2mff |
| Insertion strength: | Maximum (per positions): 49.0 N |
| Withdrawal strength | Minimum (per positions): 4.9N |
| Durability | 20 cycles |
| Locking strength | Minimum: 196 N |

Positions/Wire Size/Rated Current

Unit: A (Amps)

| Position | Series | Wire Size(AWG) | | | | | |
|----------|---------------------------------|----------------|----|----|----|----|----|
| | | 18 | 14 | 12 | 10 | 8 | 6 |
| 4 | BOARD-to wire | 18 | 23 | 31 | 35 | 50 | 60 |
| 4 | Wire-to-wire | - | - | 31 | 35 | 55 | 65 |
| 4 | (Wire-to-wire cable clamp type) | - | - | 25 | 35 | 45 | 55 |

Product Specification

| | |
|---|-----------|
| Product Specifications | 108-78470 |
| TEST REPORT | 501-78004 |
| Extraction tool application specification | 408-78147 |
| Applications Specifications | 114-5452 |

When applicable, please be sure to order the operation manual. It can also be found in the online electronic specifications catalog.

Materials and Plating

| Type | Item | Tab contact | Receptacle Contact (Crown-shaped Terminal) |
|------------------------------------|-----------|---|--|
| Receptacle Contacts Tab Contact | Materials | Copper | Copper alloys |
| | Plating | Silver plating with Nickel under-plated | Gold plating with Nickel under-plated |
| Board Mount Header | Materials | Copper | |
| | Plating | Silver plating with Nickel under-plated | |
| Housing | Materials | UL94V-0, Thermoplastic PBT containing glass fiber | |

Safety Standards

The safety specifications listed below are approved on specific part numbers. Please contact our Technical Support Centre to check whether the part numbers you use are approved or not. Keep in mind that there are instances where values differ from those given by Tyco Electronics Specifications.

| STD. | Series | D-7100Series | | | D-7300Series | | | | | | | | | | | | | | | | | | | | | | | | | | | | | | | | | | | | | | | | | | | | | | | | | | | | | | | | | | | | | | | | |
|---|--------------|---------------|---|--------------------------------------|---------------|--|--|-----|---------------|-------------|----|----|---|---|----|----|---|---|----|----|----|----|----|----|----|----|---|----|----|----|---|----|----|----|---------------|------------|---|-----|--------------|--|--|-----|---------------|-------------|----|----|---|---|----|----|---|---|----|----|----|----|----|----|----|----|---|----|----|----|---|----|----|----|---------------|
| | | Rated Voltage | Rated Current | Temperature Range | Rated Voltage | Rated Current | Temperature Range | | | | | | | | | | | | | | | | | | | | | | | | | | | | | | | | | | | | | | | | | | | | | | | | | | | | | | | | | | | | | | |
| Product Specifications 108-5453 | | 630V AC/DC | (As shown above) | -55°C ~+105°C | 630V AC/DC | (As shown above) | -55°C ~+105°C | | | | | | | | | | | | | | | | | | | | | | | | | | | | | | | | | | | | | | | | | | | | | | | | | | | | | | | | | | | | | | |
| UL File No.E28476 (Recognized Component) | | 600V AC | Based on the requirements of Application | Uses AWG6 wires Allowable maximum 6A | 600V AC | Based on the requirements of Application | Based on the requirements of Application | | | | | | | | | | | | | | | | | | | | | | | | | | | | | | | | | | | | | | | | | | | | | | | | | | | | | | | | | | | | | | |
| TOV License No. R50252537 IP protection Socket: IP-10 Plug: IP-00 Overvoltage type (II) 50 cycles of repeated plugging and unplugging | | 630V AC/DC | <table border="1"> <thead> <tr> <th rowspan="2">AWG</th> <th colspan="3">4-No of Pos.</th> </tr> <tr> <th>WTW</th> <th>WIRE-TO-BOARD</th> <th>Spring Type</th> </tr> </thead> <tbody> <tr> <td>16</td> <td>18</td> <td>-</td> <td>-</td> </tr> <tr> <td>14</td> <td>23</td> <td>-</td> <td>-</td> </tr> <tr> <td>12</td> <td>31</td> <td>31</td> <td>25</td> </tr> <tr> <td>10</td> <td>35</td> <td>35</td> <td>35</td> </tr> <tr> <td>8</td> <td>50</td> <td>55</td> <td>45</td> </tr> <tr> <td>6</td> <td>60</td> <td>65</td> <td>55</td> </tr> </tbody> </table> | AWG | 4-No of Pos. | | | WTW | WIRE-TO-BOARD | Spring Type | 16 | 18 | - | - | 14 | 23 | - | - | 12 | 31 | 31 | 25 | 10 | 35 | 35 | 35 | 8 | 50 | 55 | 45 | 6 | 60 | 65 | 55 | -55°C ~+105°C | 630V AC/DC | <table border="1"> <thead> <tr> <th rowspan="2">AWG</th> <th colspan="3">4-No of Pos.</th> </tr> <tr> <th>WTW</th> <th>WIRE-TO-BOARD</th> <th>Spring Type</th> </tr> </thead> <tbody> <tr> <td>16</td> <td>18</td> <td>-</td> <td>-</td> </tr> <tr> <td>14</td> <td>23</td> <td>-</td> <td>-</td> </tr> <tr> <td>12</td> <td>31</td> <td>31</td> <td>25</td> </tr> <tr> <td>10</td> <td>35</td> <td>35</td> <td>35</td> </tr> <tr> <td>8</td> <td>50</td> <td>55</td> <td>45</td> </tr> <tr> <td>6</td> <td>60</td> <td>65</td> <td>55</td> </tr> </tbody> </table> | AWG | 4-No of Pos. | | | WTW | WIRE-TO-BOARD | Spring Type | 16 | 18 | - | - | 14 | 23 | - | - | 12 | 31 | 31 | 25 | 10 | 35 | 35 | 35 | 8 | 50 | 55 | 45 | 6 | 60 | 65 | 55 | -55°C ~+105°C |
| AWG | 4-No of Pos. | | | | | | | | | | | | | | | | | | | | | | | | | | | | | | | | | | | | | | | | | | | | | | | | | | | | | | | | | | | | | | | | | | | | |
| | WTW | WIRE-TO-BOARD | Spring Type | | | | | | | | | | | | | | | | | | | | | | | | | | | | | | | | | | | | | | | | | | | | | | | | | | | | | | | | | | | | | | | | | | |
| 16 | 18 | - | - | | | | | | | | | | | | | | | | | | | | | | | | | | | | | | | | | | | | | | | | | | | | | | | | | | | | | | | | | | | | | | | | | | |
| 14 | 23 | - | - | | | | | | | | | | | | | | | | | | | | | | | | | | | | | | | | | | | | | | | | | | | | | | | | | | | | | | | | | | | | | | | | | | |
| 12 | 31 | 31 | 25 | | | | | | | | | | | | | | | | | | | | | | | | | | | | | | | | | | | | | | | | | | | | | | | | | | | | | | | | | | | | | | | | | | |
| 10 | 35 | 35 | 35 | | | | | | | | | | | | | | | | | | | | | | | | | | | | | | | | | | | | | | | | | | | | | | | | | | | | | | | | | | | | | | | | | | |
| 8 | 50 | 55 | 45 | | | | | | | | | | | | | | | | | | | | | | | | | | | | | | | | | | | | | | | | | | | | | | | | | | | | | | | | | | | | | | | | | | |
| 6 | 60 | 65 | 55 | | | | | | | | | | | | | | | | | | | | | | | | | | | | | | | | | | | | | | | | | | | | | | | | | | | | | | | | | | | | | | | | | | |
| AWG | 4-No of Pos. | | | | | | | | | | | | | | | | | | | | | | | | | | | | | | | | | | | | | | | | | | | | | | | | | | | | | | | | | | | | | | | | | | | | |
| | WTW | WIRE-TO-BOARD | Spring Type | | | | | | | | | | | | | | | | | | | | | | | | | | | | | | | | | | | | | | | | | | | | | | | | | | | | | | | | | | | | | | | | | | |
| 16 | 18 | - | - | | | | | | | | | | | | | | | | | | | | | | | | | | | | | | | | | | | | | | | | | | | | | | | | | | | | | | | | | | | | | | | | | | |
| 14 | 23 | - | - | | | | | | | | | | | | | | | | | | | | | | | | | | | | | | | | | | | | | | | | | | | | | | | | | | | | | | | | | | | | | | | | | | |
| 12 | 31 | 31 | 25 | | | | | | | | | | | | | | | | | | | | | | | | | | | | | | | | | | | | | | | | | | | | | | | | | | | | | | | | | | | | | | | | | | |
| 10 | 35 | 35 | 35 | | | | | | | | | | | | | | | | | | | | | | | | | | | | | | | | | | | | | | | | | | | | | | | | | | | | | | | | | | | | | | | | | | |
| 8 | 50 | 55 | 45 | | | | | | | | | | | | | | | | | | | | | | | | | | | | | | | | | | | | | | | | | | | | | | | | | | | | | | | | | | | | | | | | | | |
| 6 | 60 | 65 | 55 | | | | | | | | | | | | | | | | | | | | | | | | | | | | | | | | | | | | | | | | | | | | | | | | | | | | | | | | | | | | | | | | | | |

D-7000 Series Contact

■ Crimped Types

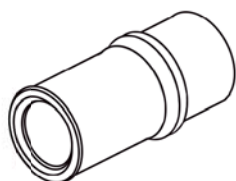

Receptacle Contact
(Receptacle housing usage)

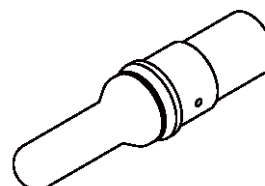

Tab contact
(Tab housing usage)

• Gold-plated Receptacle contact, Silver plated Tab contact

| Wire Range | | Outside Diameter of Insulation mm | Diameter of Contacts | | Applicable tools | |
|------------|-----------------|--------------------------------------|----------------------|-------------|------------------|--------------|
| AWG | mm ² | | Receptacle Contact | Tab contact | | |
| 16-14 | 1.6-2.6 | 10 | 1871132-4 | — | 409777-1※1 | |
| 12-10 | 2.7-6.6 | 10 | 1871132-3 | STD. | 1871131-3 | 2155816-1 ※3 |
| | | | | LONG | 1-1871131-3 | 2155815-1 ※4 |
| 8 | 6.7-10.5 | 10 | 1871132-2 | STD. | 1871131-2 | 2155369-1 ※2 |
| | | | | LONG | 1-1871131-2 | |
| 6 | 10.6-16.7 | 10 | 1871132-1 | STD. | 1871131-1 | 2155810-1 ※6 |
| | | | | LONG | 1-1871131-1 | |

For details, please contact the purchase agent or sales department.

※1 Hand tool (W-shaped crimp)

※2 Electric hydraulic tool See P. 107.
If you have any questions, please contact the sales department.

※3 Mold (2155369-1 used together with the electric hydraulic tool / applicable wire: AWG#12; crimp shape: hexagon)

※4 Mold (2155369-1 used together with the electric hydraulic tool / applicable wire: AWG#10; crimp shape: hexagon)

※5 Mold (2155369-1 used together with the electric hydraulic tool / applicable wire: AWG#8; crimp shape: hexagon)

※6 Mold (2155369-1 used together with the electric hydraulic tool / applicable wire: AWG#6; crimp shape: hexagon)

The receptacle contact can be used in all receptacle housings, the tab contact can be used in all tab housings

NOTE: all products are RoHS compliant On selection.

D-7100

Type Chart

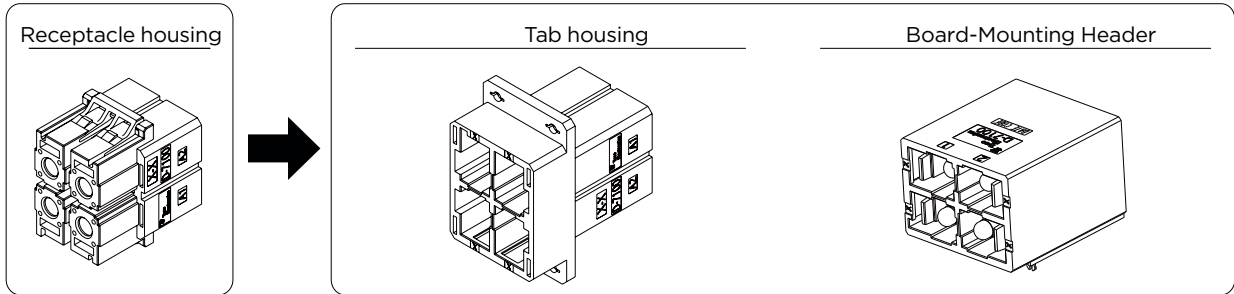

| Pos | Color | Receptacle housing | Tab housing | Plating | Board-Mounting Header |
|-----|-------|--------------------|-------------|---------|-----------------------|
| 4 | Black | 2134055-1 | 2134057-1 | Silver | 1981823-1 |

Relative Product Information

Applicable contact...P.100

Performance & Specifications...P.99

External Dimensions

■ Receptacle Housing

4P Model: 2134055-1

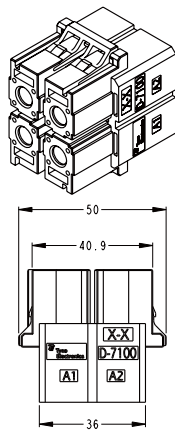

■ Tab Housing

Panel type

4P Model: 2134057-1

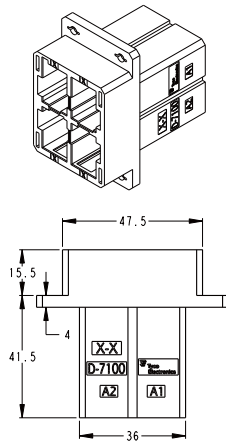

NOTE: all products are RoHS compliant On selection.

■ Board-Mounting Header

4P Model: 1981823-1

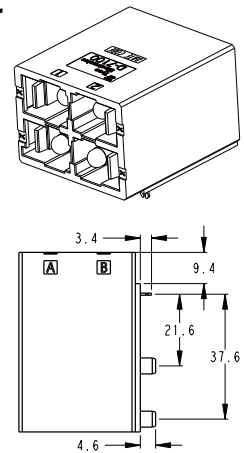

D-7300

Type Chart

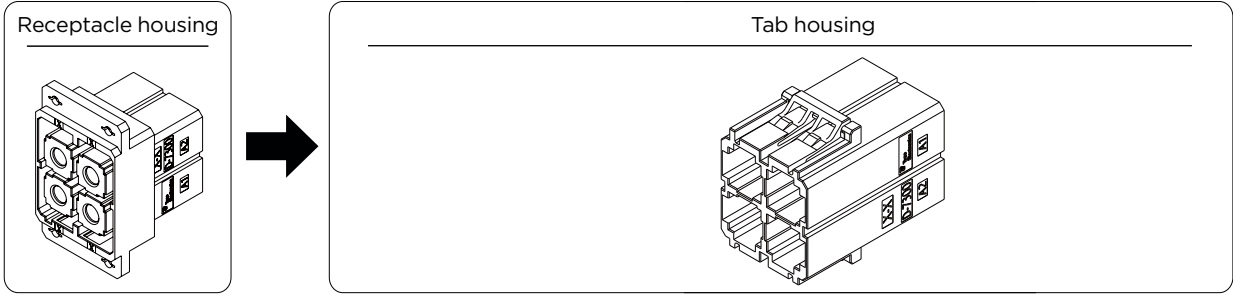

| Pos | Color | Receptacle housing | Plating | Tab housing |
|-----|-------|--------------------|---------|-------------|
| 4 | Black | 2134059-1 | Silver | 2134061-1 |

Relative Product Information

Applicable contact...P.100
 Performance & Specifications...P.99

External Dimensions

■ Receptacle Housing

4P Model: 2134059-1

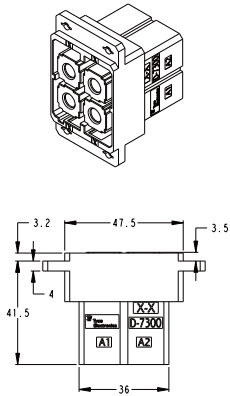

■ Tab Housing

Panel type
 4P Model: 2134061-1

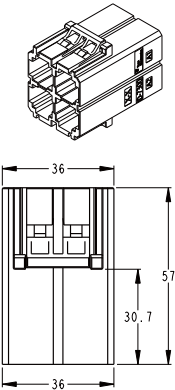

NOTE: all products are RoHS compliant On selection.

D-7100 Dyna-Clamp Kit

External Dimensions

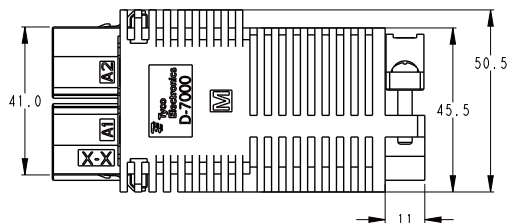

| Pos | Color | Cable Size | Part Number |
|-----|-------|------------|-------------|
| 4 | Black | S ø19 - 25 | 2-2069313-1 |
| | | M ø25 - 31 | 1-2069313-1 |

D-7300 Dyna-Clamp Kit

External Dimensions

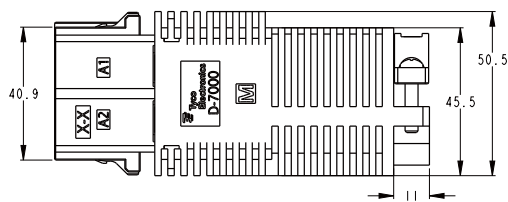

| Pos | Color | Cable Size | Part Number |
|-----|-------|------------|-------------|
| 4 | Black | S ø19 - 25 | 2-2069312-1 |
| | | M ø25 - 31 | 1-2069312-1 |

Relative Product Information

Applicable contact...P.100

Performance & Specifications...P.99

NOTE: all products are RoHS compliant On selection.

Multiple Enclosure Connector (ME Series)

Series introduction

Human machine interfaces (HMI) can be found on a variety of machines. They allow people to communicate with equipment to control, operate and program. The multiple enclosure connector was developed as a connector for I/O interfaces for HMI.

They have superior operability, are very safe, easy to use. Plus, they use Dynamic series contacts to give them very high reliability. There are two types in this series, metal and plastic, enclosures used according to the environment.

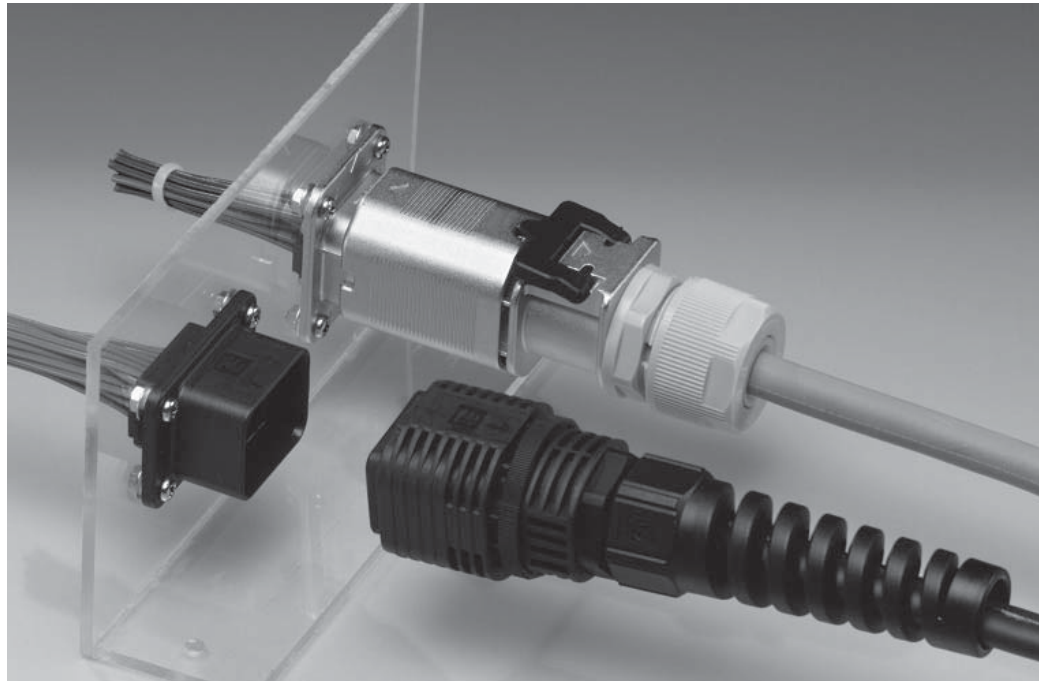

Product Features

1. Wire Sizes

The metal type fits wires with diameter from 10mm to 11mm, the plastic type from 5mm to 12mm.

2. Applicable Contacts

The highly reliable Dynamic D-1000 and D-3000 series terminals are used as contacts for I/O connectors for human machine interfaces (HMI). These can be crimped by using existing Dynamic crimping tools.

3. IP65 (plastic type), IP67 (metal type) i

The connectors have dust and water proofing for use in harsh conditions.

4. Safety Lock Mechanism

The lock mechanism uses the fast on/off lock concept which can be locked or released by just grabbing the connector. Plus, our proprietary double lock mechanism prevents vibration related disconnect accidents.

5. Two Types of Housing

The series includes two types of housing, a standard type and a reverse type for preventing exposure of live contacts.

6. Cable Clamp Interface

Cable clamps, which are commercially available and can be selected according to application and purpose, can be attached to cover the cable entering the connector.

7. Other Considerations

Audible & tactile locking design ensure the complete connection between receptacle and tab.

Multiple Enclosure Connector (ME Series)

Performance Specifications

| Item | Standard |
|------------------------------|---|
| Rated Current | See the reference |
| Rated Voltage | 125VACrms (for the part with a pitch of 2mm) |
| Dielectric Withstand Voltage | 1,000V AC (1 min) |
| Operating temperature | -30°C -105°C (including the temperature rise caused by electrification) |
| Total resistance(low level) | Maximum (initial): 10mff |
| Insulation resistance | Minimum (initial): 1,000Mff |
| Insert Strength | Maximum (per position): 39.2N |
| Withdrawal Strength | Maximum (per position): 4.9N |
| Durability | 50 cycles |
| Enclosure Lock Strength | Minimum: 98N |

Product Specification

| | |
|-----------------------------|--|
| Product Standards | 108-78417 |
| Applications Specifications | 114-5377 |
| Manual | 411-78287,78288(14+1P) 411-78262,78277(24P) |

Plastic type

| | |
|-------------------------------|----------------|
| Product Standards | 108-78566 |
| Mounting Application Standard | 114-5377 |
| Manual | 411-78293(32P) |

Contact

Refer to D-1000 contact on P. 13 and D-3000 contact on P. 39

Positions/Wire Size/Rated Current

| Contact Wire Size Position | Receptacle contacts and tab contact | | | | | | |
|----------------------------------|-------------------------------------|---------|---------|---------|---------|---------|---------|
| | AWG #18 | AWG #20 | AWG #22 | AWG #24 | AWG #26 | AWG #28 | AWG #30 |
| 24Pos | - | - | 2 | 1.5 | 1 | 0.8 | 0.5 |
| 14+1Pos | 3.5 | 2.7 | 2.5 | 2 | 1.5 | 1 | 0.8 |

Plastic type

| Contact Wire Size Position | Receptacle contacts and tab contact | | | | |
|----------------------------------|-------------------------------------|---------|---------|---------|---------|
| | AWG #22 | AWG #24 | AWG #26 | AWG #28 | AWG #30 |
| 32Pos | 1.5 | 1 | 0.8 | 0.5 | 0.5 |

Materials and Plating

Metal type

| Parts Materials | Materials | Finish |
|-----------------|----------------------------------|---------------------------------------|
| Contact | Copper alloys | Gold plating over Nickel under-plated |
| housing | UL94V-0, thermoplastic polyamide | — |
| Connector Case | Zinc | Nickel-plated |
| Packing | Nitrile rubber | — |
| Shield Grip | Cold-rolled steel | Nickel plating over copper base |

Plastic type

| Description | Materials | Finish |
|---------------------------|--|---------------------------------------|
| Contact | Copper alloys | Gold plating over Nickel under-plated |
| Connector housing | UL94V-0, thermoplastic polyamide | — |
| Connector Case for bottom | UL94V-0, thermoplastic polyamide Nitrile rubber | — |

Multiple Enclosure Connector (ME Series)

Type Chart

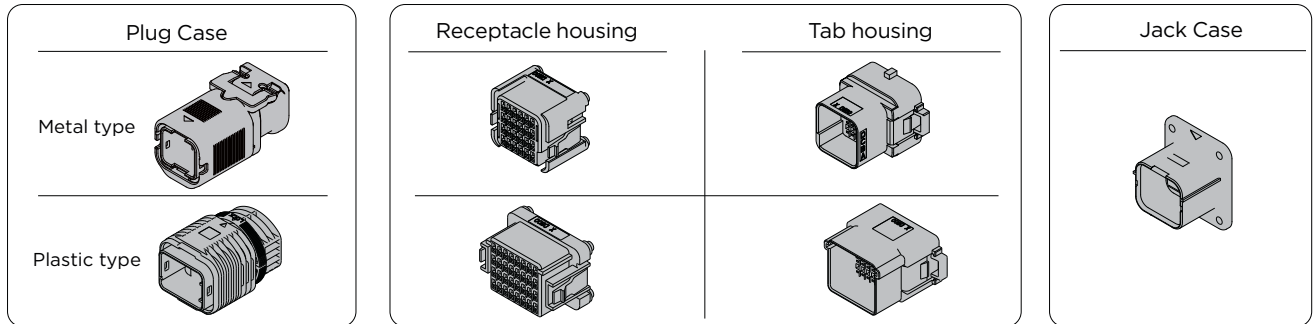

| Type | Pos. | Plug Case | Polarity | Housing | | Jack Case |
|----------------------|------|-----------|----------|--------------------------|--------------|-----------|
| | | | | Receptacle (R) / Tab (T) | | |
| Metal housing type | 24 | 1939847-1 | Standard | 1939850-1(R) | 1939839-1(T) | 1939840-1 |
| | | 1981560-1 | Reverse | 1981556-1(T) | 1981551-1(R) | |
| Metal housing type | 14+1 | 1939847-1 | Standard | 1981135-1(R) | 1981133-1(T) | 1939840-1 |
| | | 1981560-1 | Reverse | 1981947-1(T) | 1981945-1(R) | |
| Plastic housing type | 32 | 1981919-1 | Standard | 1981921-1(R) | 1981914-1(T) | 1981913-1 |
| | | | Reverse | 2013393-1(T) | 2013391-1(R) | |

Shield clip P / N 1939851 -1 (plug case) tool: 1891820 -1 (411-78273)

Relative Product Information

Applicable contact... 24 position product: D-1000 S.M contacts see P. 13.
 14+1 position product: The D-1000 & D-3000 contacts see P. 13 and 39
 32 position product: D-1000 S.M contacts see P. 13

External Dimensions

■ Receptacle Housing

Standard Type (Plug Case)

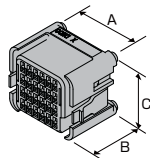

| Pos | Key | Plating | Color | Part Number | Dimensions | | |
|------|-----|---------|-------|-------------|------------|------|------|
| | | | | | A | B | C |
| 24 | — | — | Black | 1939850-1 | 19.6 | 15.3 | 16.8 |
| 14+1 | — | — | Black | 1981135-1 | 22.0 | 22.8 | 16.8 |
| 32 | — | — | Black | 1981921-1 | 27.2 | 15.3 | 17.6 |

Reverse (Jack Case)

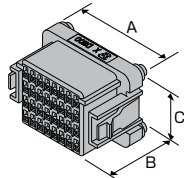

| Pos | Key | Plating | Color | Part Number | Dimensions | | |
|------|-----|---------|-------|-------------|------------|------|------|
| | | | | | A | B | C |
| 24 | — | — | Black | 1981551-1 | 27.5 | 23.7 | 20.2 |
| 14+1 | — | — | Black | 1981945-1 | 27.5 | 23.7 | 20.2 |
| 32 | — | — | Black | 2013391-1 | 29.5 | 23.0 | 17.0 |

NOTE: all products are RoHS compliant On selection.

■ Tab Housing

Standard Type (Jack Case)

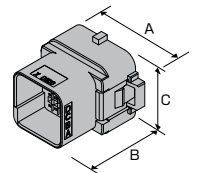

| Pos | Key | Plating | Color | Part Number | Dimensions | | |
|------|-----|---------|-------|-------------|------------|------|------|
| | | | | | A | B | C |
| 24 | — | — | Black | 1939839-1 | 27.5 | 23.3 | 20.0 |
| 14+1 | — | — | Black | 1981133-1 | 27.3 | 27.5 | 20.2 |
| 32 | — | — | Black | 1981914-1 | 29.5 | 22.3 | 17.0 |

Reverse (Plug Case)

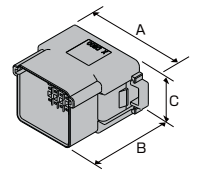

| Pos | Key | Plating | Color | Part Number | Dimensions | | |
|------|-----|---------|-------|-------------|------------|------|------|
| | | | | | A | B | C |
| 24 | — | — | Black | 1981556-1 | 19.6 | 20.8 | 16.8 |
| 14+1 | — | — | Black | 1981947-1 | 22.8 | 28.2 | 16.8 |
| 32 | — | — | Black | 2013393-1 | 27.2 | 20.0 | 17.6 |

Applicable Tools

■ AMP - 3K/AMP - 5 K Tabletop Crimping Machine.

AMP - 3K/AMP - 5 K is a compact, low-cost desktop crimping machine. A DC motor linear scheme is used for low noise, and motor speed adjustment can be easily changed. It offers a wide range of crimping operations options with simple operation and a comfortable working environment.

- It can be equipped with other companies' application tools.
- The crimping height can be adjusted at 0.013 mm per step.
- It can be used with a power supply of AC100V/240V.
- Low noise and easy speed adjustment are achieved due to the DC motor drive.
- Multiple modes and optional parts are available depending on the operating environment.

| Name | | AMP-3K | AMP-5K |
|--------------|---------------------------|---|-------------|
| Part Number | Type Universal mount type | 1725950-3 | 1725900-3 |
| | AMP quick mount type | 1-1725950-2 | 1-1725900-2 |
| Stroke | | 30 mm | |
| Dimensions | | The application tool is mounted on the safety cover closed side (no reel): 512mm (width) x415mm (depth) x510mm (height) The application tool is mounted on the safety cover closed end (no reel): 427mm (width) x523mm (depth) x510mm (height) | |
| Weight | | About 70kg (main body of the crimping machine) | |
| Power supply | | AC100-240V (310%) Single-phase 50 / 60Hz (6A) | |
| Cycle time | | 0.4 s (when the jog mode is terminated) | |



■ SCM Stripper Crimping Machine (Tabletop Crimping Machine)

Stripper Crimping Machine with exchangeable Dies. With optimum processing of jacket cable ends, the operator selects among strip and crimp, strip only or crimp only with one touch.

| Type | AMP-3K Specification 1596509-3 | AMP-5K Specification 1596509-4 |
|-------------------------|--|--|
| Applicable Wire | AWG 32-14 with the maximum skin outer diameter of 5.08mm (some AWG32-30 wires are inapplicable.) Please contact us for details. | |
| Jacket strip Dimensions | Min 29mm (or wire set if the peeling size is 29-45mm) The time is longer than usual. | |
| Strip Length | 2.5-10mm | |
| Usable Applicators | Our company's 40mm stroke side feed application tool | |
| Noise level | < 82 dB | |
| Crimp ability | 13,345N (1,360kgf) Can be crimped to the AWG14 | 22,226N(2,268kgf) Can be crimped to the AWG10 (or to AWG14, if it is an SCM) |
| Power supply | AC 100-240V single phase 50/60Hz | |
| Air pressure | 0.49 - 0.59MPa (5 - 6kg/cm2) | |
| Machine weight | About 80 kg | |

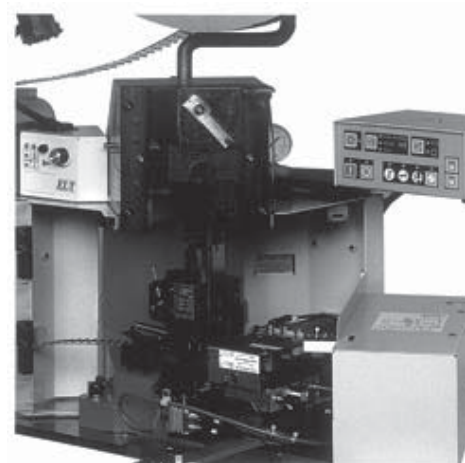

AMP-3K Specification SCM

Applicable Tools

■ TE REC-Li 250 M (charging hydraulic multi-function tool)

- The lithium-ion battery is the lightest in its class.
- High power due to dual Battery-electric & hydraulic pump use.

Product Specification Rated output 54 kN
 Crimp Range: 5.5 to 60mm² electric machine:
 14.4 V DC motor
 External dimensions 286 mm (length) x 285mm (H) x 75mm (width) Weight: 2.7 kg (6 lb) (60 mm 2 Dices, battery pack included)
 No. of times can be crimped: 270 times (60 mm 2crimp per hour),
 Manufacturer Part Number: 2155363 - □

■ TE REC-Li 250 M (charging hydraulic multi-function tool)

Product Specification Rated output 127kN
 Crimp Range: 14 to 250 mm² (copper wire bare pressure terminal and sleep)
 Electric motor: 14.4 V DC motor
 External dimensions 340mm (length) x 280mm (H) x 75mm (width)
 Weight: 4.2kg (250mm 2 Dices, battery pack included)
 No. of times can be crimped: 50 times (250mm 2crimp per hour),
 Manufacturer Part Number: 2155363 - □



■ Key Plug-equipped D-1000 Series

Part Number:1939588-1

■ Key Plug-equipped D-2000 Series

(Used to prevent misinsertion)
 Avoid mis-plugging when connectors with the same No of Pos. are used together.

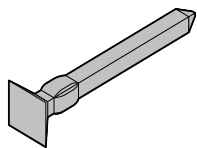

Part Number:641994-1

■ Key Plug-equipped D-3000 Series

(Used to prevent mis-plugging) Avoid mis-plugging when connectors with the same No of Pos. are used together.

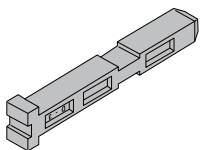

Part Number:175855-1

■ Receptacle Contact Cutting Tool D-1000 Series

Part Number: 919041-3
 Application Specification: 411-78047

■ Receptacle Contact Cutting Tool D-2000 Series

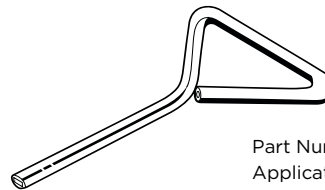

Part Number: 919041-2
 Application Specification: 411-78047

■ Receptacle Contact Cutting Tool Series D-3000 Series

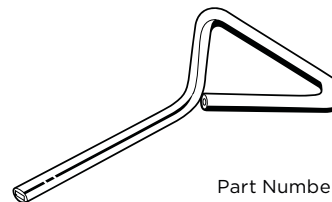

Part Number: 919041-1
 Application Specification: 411-78047

Applicable Tools

■ How to use the plug and cutting tool

※It should be noted that some of the products (D-2100 S/D-2100 D) to prevent mis-insertion, use keying mechanism from the beginning.

①Keying Plug inserted in one pole of the receptacle housing.

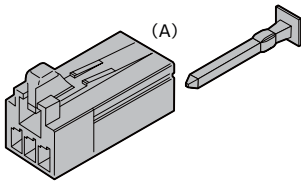

②Wrench off a tab in the corresponding position of mating Tab Header and empty that position. To wrench off the tab, insert Cutting Jig into its root and turn tool as shown.

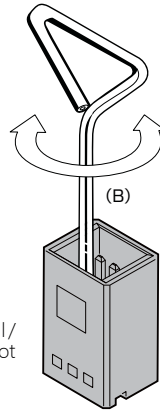

※*In tab Housing (Panel/freehanging type), 1 pole is not inserted and is left free.

■ How to use the plug and tool for the D-3000 Series

In addition, mis-insertion function keying has been installed from the beginning in some of the products (D-3100S/ D-3100M/ D-3200S/D-3200M)

①The keying plug is inserted into the receptacle housing

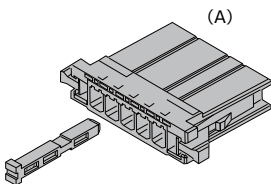

②Wrench off a tab in the corresponding position of mating Tab Header and empty that position. To wrench off the tab, insert Cutting Jig into its root and turn tool as shown

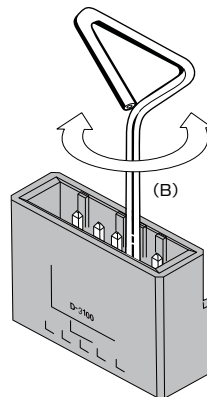

* In tab Housing (Panel/freehanging type), 1 pole is not inserted and is left free.

③When using these, it is impossible to mis-insert

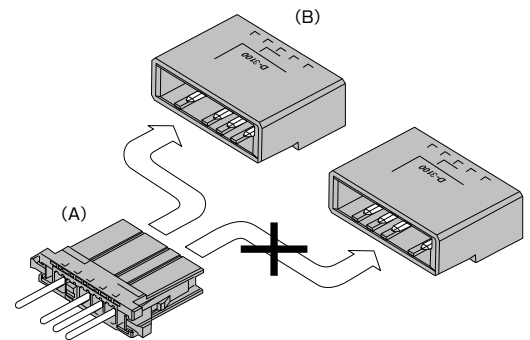

■ Hand tools PEW 12, D-1000, D-3000 and D-4000 series



- Crimping with a straight action feel
By manipulating the fulcrum of the handle, we have created a crimper that, while double action, is almost like straight action.
- Interchangeable dies
The dies are easy to change. This means a wide variety of terminals can be handled with the minimum number of tools.
- Improve work efficiency
Contact series, wire sizes and crimp heights printed on work surface of dies.
- Lower cost than existing specialized tools
The superior functionality you want, at a price you like.

Applicable Tools

■ **Hand Tools CERTI-CRIMP II, D-1000 Series Flip Locator, D-2000 Series, D-3000 Series, D-5000 Series**
Crimp part, as well as the machine, are highly reliable, Straight action method is introduced.



D-1000 series with Flip Locator

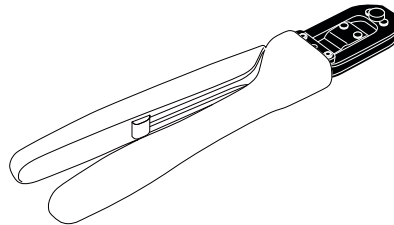

Part Number: See P. 29, 39, 81.

- Handles are completely covered in urethane to be easy to grip and gentle to workers, hands. Wire ranges and crimping height control values are printed on the crimping head for easy confirmation while working. Also, the ratchet in the handle keeps crimping quality very consistent. Hand crimping tool with wire stripper has four variations, while the previous model had only three variations. We recommend periodic maintenance when using hand crimping tools to keep crimping quality consistent.

■ Hand Tool D-4000 Series

Crimper uses the reliable straight action method

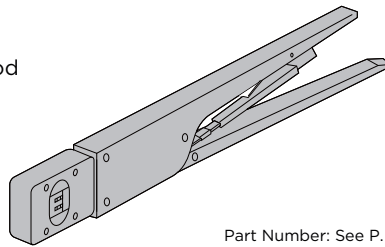

Part Number: See P. 74

■ Hand Tool D-5000 Series

As with machine use, the reliable straight action method is used.

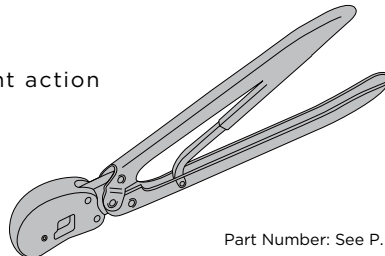

Part Number: See P. 81

■ Extraction Tool for D-1000 Series

Used to pull D-1000 from the housing

Part Number:1891526-1
Manual: 411-78241

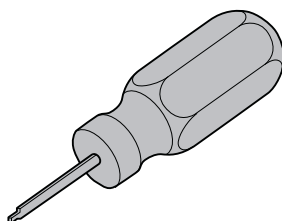

■ Extraction Tool for D-2000 Sseries

Used to pull D-2000 contacts from the housing

Part Number:1276716-1

Applicable Tools

■ Extraction Tool for D-3000 Series

wiring type tool for pulling the contact from the housing

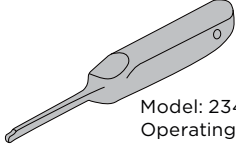

Model: 234168-1
Operating Manual: 411-5726

Using the extractor

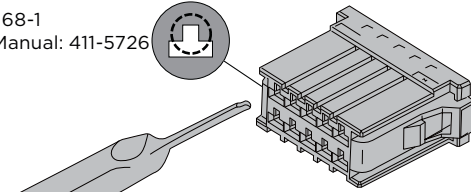

① Extractor tool is inserted into the small, upper part of the convex hole in the housing as shown in the diagram (please hold the tool the right way up)

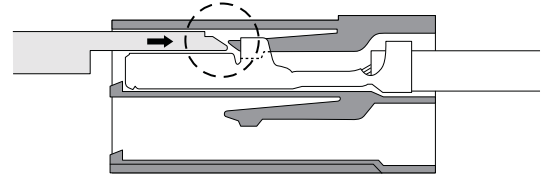

② The tip of the tool lifts the housing lance and frees the contact

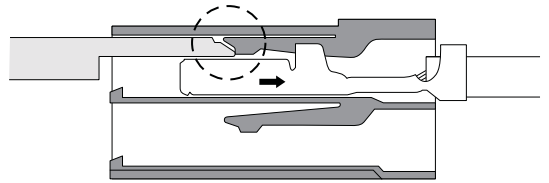

③ Contact can be withdrawn

* Take care not to insert into the Contact Section. If you have inserted by error, replace the damaged contact with a new one before proceeding.

■ Extraction Tool for D-5000 Series

Wiring type tool for pulling the contact from the tab / receptacle housing (between D-3 and D-5 the lance part is inverted, so please take care on insertion) In D-5 contact only, pulling can be achieved with a small O-driver or awl. Please note that the contact cannot be inserted into the contact section. If you have inserted by mistake, please replace and use a new one.

Part number: 409158-1
Manual: 411-5774

Using the Extraction Tool

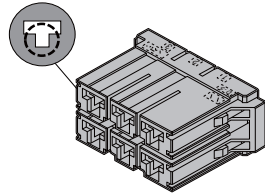
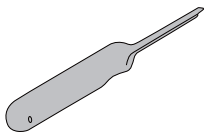

① The pulling tool should be inserted into the narrow part of bottom, with convex hole in the housing as shown in the diagram.

If using the D-5 Extraction Tool

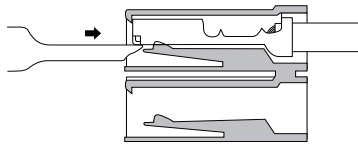

② The tip of the tool lifts the housing lance and frees the contact

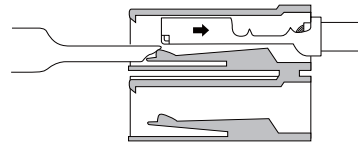

③ Contact can be withdraw

If using a small O-driver or awl

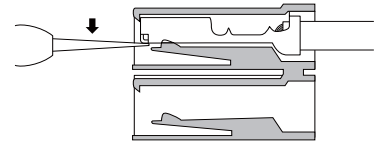

② The tip pushes down the lance part and frees the contact

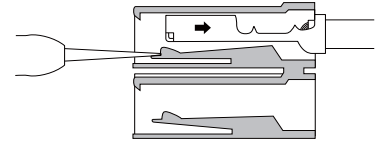

③ Contact can be withdraw

■ Unplugging tool D-7000 series

Part Number: 2040080-1
Operation Manual: 408-78147



Please be sure that it is not inserted into the terminal position. If it is inserted incorrectly, replace the terminal with a new one.

■ Crimping Oil Model number

Part Number: 939691-1
For easing the friction between tool and contact during crimping



■ Sequence clip

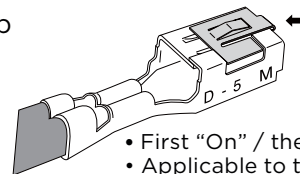

- First "On" / then "Off"
- Applicable to the D-5 terminal only

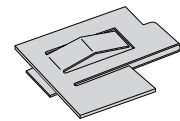

Part Number: 179993-1

Accessories

■ L-bracket D3000

Used to secure free-hanging type tab housings onto panels. Two styles, large and small, are available, the former for large-sizes housings and the latter for small housings. Applicable housings are specified in the table of housings 5900121-2 (S), 5900121-4(L)

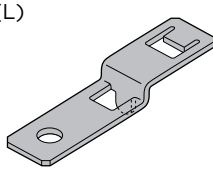

Part Number:5900121-2 (S)

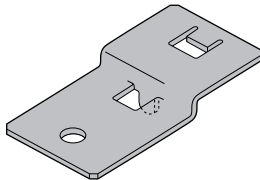

Part Number:5900121-4(L)

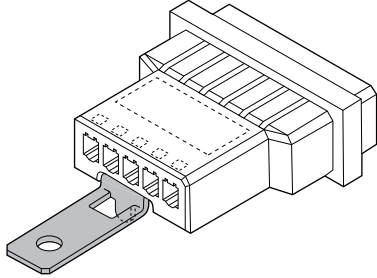

■ Push rivets

Used to secure panel-type tab housings onto panels (Use as a handy mounting hardware. Cannot be used with larger sized housings or those that are frequently inserted and withdrawn).

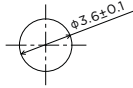
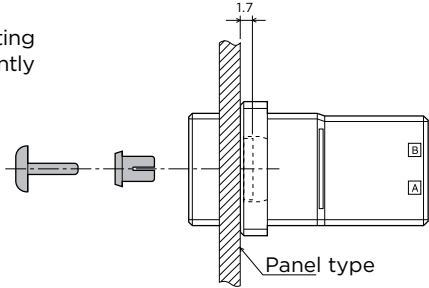
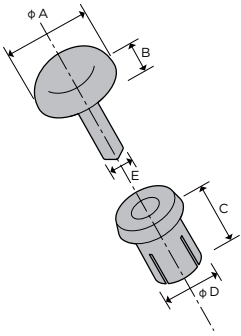

Panel Hole Machining recommended

| Part Number | Panel Thickness | Dimensions | | | | | Insertion Strength | Retention Force |
|-------------|-----------------|------------|-----|-----|-----|------|--------------------|-----------------|
| | | A | B | C | D | E | | |
| 900128-1 | 0.3-1.3 | 6.4 | 1.6 | 4.5 | 3.5 | 1.95 | 19.6N-29.4N | 127.4N Min.* |
| 900128-2 | 1.3-2.3 | 6.4 | 1.6 | 5.5 | 3.5 | 1.95 | 19.6N-29.4N | 127.4N Min.* |

*when using 2

Panel Mounting Screws D-2000, D-3000

| Part Number | Dimensions | | |
|-------------|------------|------|----|
| | A | B | C |
| 900167-1 | 9.0 | 10.3 | M3 |

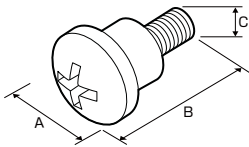

Panel Mounting Hex Screws D-2000

| Part Number | Dimensions | | |
|-------------|------------|------|----|
| | A | B | C |
| 1376059-1 | 5.5 | 12.3 | M3 |

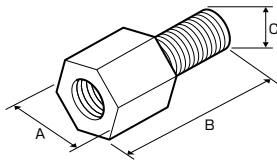

Cable Glands

Plastic Gland



Material: PA
 Press seal material: PA
 Seal material: EPDM
 Temperature range: -40°C-+100°C
 Protection: IP68

| Metr. | Dimension D | | SW | Type | Part Number | Color of Housing |
|---------|-------------|---------|----|------------|-----------------|------------------|
| | Minimum | Maximum | | | | |
| M20*1.5 | 5 | 9 | 24 | HSK-M20B-H | T3209201112-001 | Black |
| | 6 | 12 | 24 | HSK-M20B | T3209201122-001 | Black |
| | 8 | 14 | 27 | HSK-M20B-D | T3209201102-001 | Black |
| | 5 | 9 | 24 | HSK-M20G-H | T3209201212-001 | Grey |
| | 6 | 12 | 24 | HSK-M20G | T3209201222-001 | Grey |
| | 8 | 14 | 27 | HSK-M20G-D | T3209201202-001 | Grey |

Metal Gland



Material: Nickel plated brass
 Press seal material: PA
 Seal material: NBR
 Temperature range: -40°C-+100°C
 Protection: IP68

| Metr. | Dimension D | | SW | Type | Part Number |
|---------|-------------|---------|----|-----------|-----------------|
| | Minimum | Maximum | | | |
| M20*1.5 | 5 | 9 | 22 | DLX-20-MT | T3609200112-000 |
| | 6 | 12 | 22 | DLX-20-M | T3609200102-000 |
| | 10 | 14 | 24 | DLX-20-MB | T3609200122-000 |

EMC cable glands



Material: Nickel plated brass
 Press Seal Material: PA
 Temperature range: -40°C-+100°C
 Protection: IP68

| Metr. | Dimension D | | SW | Type | Part Number |
|---------|-------------|---------|----|------------|-----------------|
| | Minimum | Maximum | | | |
| M20*1.5 | 5 | 9 | 24 | DLX-20-MTC | T3707200113-000 |
| | 7 | 12 | 22 | DLX-20-MC | T3706200103-000 |

Part basic number index

Tools and Equipment

| Part Number | Page | Part Number | Page |
|-------------|----------|-------------|-----------|
| 91558 | 36,39 | 2151240 | 29 |
| 91559 | 36,39 | 2155369 | 81,90,100 |
| 91560 | 36,39 | 2155502 | 81 |
| 91561 | 36,39 | 2155503 | 81 |
| 91565 | 36,39 | 2155810 | 100 |
| 91596 | 79,81,90 | 2155814 | 100 |
| 234170 | 79,81,90 | 2155815 | 100 |
| 234171 | 79,81,90 | 2155816 | 100 |
| 409777 | 100 | 2155822 | 81,90 |
| 1366044 | 79,81,90 | 2266273 | 81 |
| 1366658 | 90 | 2266274 | 81 |
| 1366659 | 90 | 2266289 | 74 |
| 1366660 | 90 | 2836130 | 39 |
| 1366757 | 90 | | |
| 1426229 | 90 | | |
| 1426325 | 90 | | |
| 1528106 | 90 | | |
| 1762119 | 74 | | |
| 1762120 | 74 | | |
| 1762129 | 72,74 | | |
| 1762130 | 72,74 | | |
| 1762453 | 13 | | |
| 1762625 | 13 | | |
| 1762626 | 13 | | |
| 1762670 | 74 | | |
| 1762671 | 74 | | |
| 1762674 | 74 | | |
| 1762675 | 74 | | |
| 1762846 | 13 | | |
| 1762847 | 13 | | |
| 1762950 | 13 | | |
| 1762951 | 13 | | |
| 1762952 | 13 | | |
| 2047670 | 74 | | |
| 2114042 | 13 | | |
| 2114043 | 13 | | |
| 2119141 | 13 | | |
| 2119142 | 13 | | |
| 2119143 | 13 | | |
| 2119144 | 13 | | |
| 2151018 | 39 | | |
| 2151071 | 29 | | |
| 2151073 | 39 | | |
| 2151080 | 39 | | |
| 2151082 | 13 | | |
| 2151083 | 13 | | |
| 2151086 | 81 | | |
| 2151119 | 39 | | |

Housing

| Part Number | Page | Part Number | Page |
|-------------|----------------|-------------|-------|
| 175362 | 58,59 | 1827691 | 70 |
| 175363 | 58,59 | 1827862 | 15,16 |
| 177648 | 40,41 | 1827863 | 15,16 |
| 178127 | 46 | 1827864 | 19,20 |
| 178128 | 47,48,56,70 | 1871416 | 96,97 |
| 178129 | 50,51,56 | 1871417 | 96,97 |
| 178214 | 57 | 1871418 | 96,97 |
| 178288 | 40,41,43,46,69 | 1871419 | 96,97 |
| 178289 | 44,45 | 1871465 | 18 |
| 178802 | 40,41 | 1871946 | 25 |
| 178803 | 44,45 | 1903127 | 15,16 |
| 178964 | 44,45 | 1903128 | 15,16 |
| 179552 | 47,48 | 1903129 | 18 |
| 179553 | 47,48 | 1903130 | 19,20 |
| 179554 | 50,51,53,54 | 1903131 | 19,20 |
| 179555 | 50,51,53,54 | 1903146 | 87 |
| 179958 | 82,83,87,91 | 1903329 | 77 |
| 353046 | 82,83,88,89 | 1903330 | 77 |
| 353047 | 82,83,88,89 | 1903331 | 77 |
| 917241 | 58,59 | 1939758 | 14 |
| 917242 | 58,59 | 1939839 | 106 |
| 917249 | 57 | 1939850 | 106 |
| 917266 | 53,54 | 1971003 | 69 |
| 917659 | 50,51 | 1971150 | 24 |
| 917807 | 84,85,91 | 1971151 | 24 |
| 917808 | 84,85,88,89 | 1971182 | 24 |
| 917809 | 84,85,88,89 | 1971239 | 88 |
| 1318095 | 58,59 | 1981133 | 106 |
| 1318114 | 31,32 | 1981135 | 106 |
| 1318115 | 31,32 | 1981551 | 106 |
| 1318116 | 30 | 1981556 | 106 |
| 1318117 | 30 | 1981914 | 106 |
| 1318118 | 31,32 | 1981921 | 106 |
| 1318119 | 31,32 | 1981945 | 106 |
| 1318120 | 30 | 1981947 | 106 |
| 1318577 | 33 | 2013285 | 87 |
| 1318578 | 33 | 2013391 | 106 |
| 1376072 | 33 | 2013393 | 106 |
| 1376073 | 33 | 2040404 | 22,23 |
| 1376807 | 69 | 2040444 | 22,23 |
| 1473074 | 30 | 2069029 | 22 |
| 1473668 | 88 | 2069524 | 95 |
| 1747276 | 75,76 | 2069526 | 95 |
| 1747363 | 96,97 | 2069681 | 15,16 |
| 1747364 | 96,97 | 2069682 | 15,16 |
| 1747365 | 96 | 2134055 | 101 |
| 1747366 | 96 | 2134057 | 101 |
| 1747414 | 75,76 | 2134059 | 102 |
| 1747535 | 75,76 | 2134061 | 102 |
| 1747819 | 86 | 2291727 | 55 |
| 1747820 | 86 | 2291728 | 55 |
| 1747821 | 86 | 2333134 | 15,16 |
| 1747822 | 86 | 2333149 | 15,16 |
| 1827540 | 34 | 2349949 | 19,20 |
| 1827579 | 22,24 | 2350416 | 15,16 |

请使用互联网电子规格目录。
INTERNET Electronic Catalog Offered For Your Use.

www.te.com

本电子规格目录可根据“型号”“产品名称”“产品类型”等进行搜索，可在短时间内搜索到符合特定规格的产品。包括客户图纸在内，可简单提取到详细信息。采用时，请务必下载客户图纸后使用。

Using this Electronic Catalog, you can retrieve information by product category, part number and product name. It is possible to search and locate information on products that meet specific specifications in minutes. Customer drawings included, detailed product information can be extracted easily.

操作步骤
(Electronic Catalog Procedure)

可查阅RoHS标准。
You can search for the RoHS regulation information.

1 访问上述地址，出现右边的窗口：
Upon the access to our website, the following page will come appear.

2 光标对准产品信息，出现菜单。单击产品搜索，出现以下窗口，显示操作方法示例，请按需求方式进行搜索。

Moving the cursor here takes you to the product search menu. If you select the product search menu, the following page will show you examples of how to operate. Please operate with the suitable method to your needs.



单击此处，弹出右边窗口。
Click this button to get the page shown right.



输入产品型号，单击搜索，出现右边的窗口。(※171825-2 为型号输入示例。)

After entering part number, click Search to get the page shown right.
※171825-2 is an example of part number for entering.

Documents and Drawings for: 171825-2

| Document Title | Document Type | Document ID | |
|--|-----------------------|-------------|--------------------------|
| 171825-2 (171825-2) - Description 2 POS 058 FOOT HDR | | | |
| 171825-2 (171825-2) - Description 2 POS 058 FOOT HDR | Product Specification | 108-9130 | <input type="checkbox"/> |
| 171825-2 (171825-2) - Description 2 POS 058 FOOT HDR | Product Specification | 108-9130 | <input type="checkbox"/> |
| Customer Sales Sheet (171825-2) (171825-2) | Model | 171825-2 | <input type="checkbox"/> |
| Customer Sales Sheet (171825-2) (171825-2) | Model | 171825-2 | <input type="checkbox"/> |
| Customer Sales Sheet (171825-2) (171825-2) | Model | 171825-2 | <input type="checkbox"/> |



- Product specifications may be changed for improvement purposes without prior notice. Sales of any of the products may be suspended. When discussing the use of products, be sure to request for the drawings and product Standard Type Type Types. In particular, please consult the information to confirm the tolerances of the fine mounting dimensions for the mounting of the printed circuit board.
- The product is provided with a sales batch. Please ask the sales department for the latest information.

- Dimensions, if not specified, are expressed in mm.
- The applicable wire range (AWG) contained in this specification catalogue covers the values for using the application tools. When using a hand tool, please refer to the operating manual.

TE.com

1-1773732-4 SL 08/2020

All rights reserved by © 2020 TE Connectivity and its affiliates.

“TE Connectivity,” “TE Connectivity (logo)” and “EVERY CONNECTION COUNTS” are trademarks.

Other logos and product and company names mentioned in this document are the trademarks of their respective owners.

TE has made every effort to ensure the accuracy of this product manual, but does not guarantee that there will be no errors in this document. No other statements or warranties are made regarding the accuracy, correctness, reliability or availability of the information.

TE reserves the right to make changes to the information contained in this document without prior notice. TE explicitly disclaims any implied warranties for the information contained in this catalog, including but not limited to the warranties of merchantability or fitness for a particular purpose. Dimensions in the catalog are for reference only and are subject to change without prior notice. Specifications are subject to change without prior notice. Please consult TE for the latest dimensions and design specifications.



X-ON Electronics

Largest Supplier of Electrical and Electronic Components

Click to view similar products for [Headers & Wire Housings](#) category:

Click to view products by [TE Connectivity](#) manufacturer:

Other Similar products are found below :

[892-18-020-10-001101](#) [58102-G61-06LF](#) [582553-1](#) [0009485154](#) [009176003701906](#) [0050291907](#) [LY20-4P-DT1-P1E-BR](#) [02.125.8002.8](#)
[609-3404](#) [61062-3](#) [61082-181009](#) [622-3653LF](#) [63453-116](#) [636-1030](#) [636-1427](#) [636-3427](#) [636-4007](#) [641938-9](#) [641991-4](#) [644827-2](#) [65817-](#)
[010LF](#) [65817-015LF](#) [65863-015LF](#) [66207-023LF](#) [67095-007LF](#) [67601157](#) [68645-018](#) [68648-049](#) [70.362.1628.0](#) [70-4210](#) [70-4226B](#) [70-](#)
[4853B](#) [707-5020](#) [707-5028](#) [71.350.2428.0](#) [71918-208LF](#) [71961-016LF](#) [733-134](#) [733-162](#) [754199-000](#) [760-3052](#) [787-8014-00](#) [79531-3000](#)
[FCN-360C032-B](#) [FCN-367T-T012/H](#) [FCN-723D010/2](#) [80.063.4001.1](#) [800-90-001-10-001000](#) [800-90-010-10-002000](#) [801-43-002-10-013000](#)