

5-2178600-2 ✓ ACTIVE

[RAST](#) | [RAST 5D](#)

TE Internal #: 5-2178600-2

Housing, Receptacle, Wire-to-Wire, 2 Position, .197 in [5 mm]

Centerline, Crimp, 1 Row, Black, Mating Retention, Wire & Cable,

Power & Signal, RAST 5D

[View on TE.com >](#)



Connectors > PCB Connectors > Wire-to-Board Connectors > Wire-to-Board Connector Assemblies & Housings



Connector Product Type: **Housing**

Connector & Housing Type: **Receptacle**

Connector System: **Wire-to-Wire**

Number of Positions: **2**

Centerline (Pitch): **5 mm [.197 in]**

Features

Product Type Features

Connector Product Type	Housing
Connector & Housing Type	Receptacle
Connector System	Wire-to-Wire
Sealable	No
Connector & Contact Terminates To	Wire & Cable

Configuration Features

Number of Positions	2
Number of Rows	1

Body Features

Primary Product Color	Black
-----------------------	-------

Termination Features

Termination Method to Wire & Cable	Crimp
------------------------------------	-------

Mechanical Attachment



Mating Retention Type	Lock
Mating Retention	With
Connector Mounting Type	Cable Mount (Free-Hanging)

Housing Features

Housing Material	PA 6
Centerline (Pitch)	5 mm [.197 in]

Dimensions

Row-to-Row Spacing	5 mm [.197 in]
--------------------	----------------

Usage Conditions

Operating Temperature Range	-40 – 105 °C [-40 – 221 °F]
-----------------------------	-----------------------------

Operation/Application

Circuit Application	Power & Signal
---------------------	----------------

Product Compliance

[For compliance documentation, visit the product page on TE.com>](#)

EU RoHS Directive 2011/65/EU	Compliant
EU ELV Directive 2000/53/EC	Compliant
China RoHS 2 Directive MIIT Order No 32, 2016	No Restricted Materials Above Threshold
EU REACH Regulation (EC) No. 1907/2006	Current ECHA Candidate List: JUNE 2023 (235) Candidate List Declared Against: JAN 2021 (211) Does not contain REACH SVHC
Halogen Content	Not Low Halogen - contains Br or Cl > 900 ppm.
Solder Process Capability	Not reviewed for solder process capability

Product Compliance Disclaimer

This information is provided based on reasonable inquiry of our suppliers and represents our current actual knowledge based on the information they provided. This information is subject to change. The part numbers that TE has identified as EU RoHS compliant have a maximum concentration of 0.1% by weight in homogenous materials for lead, hexavalent chromium, mercury, PBB, PBDE, DBP, BBP, DEHP, DIBP, and 0.01% for cadmium, or qualify for an exemption to these limits as defined in the Annexes of Directive 2011/65/EU (RoHS2). Finished electrical and electronic equipment products will be CE marked as required by Directive 2011/65/EU. Components may not be CE marked. Additionally, the part numbers that TE has identified as EU ELV compliant have a maximum concentration of 0.1% by weight in homogenous materials for lead, hexavalent chromium, and mercury, and 0.01% for cadmium, or qualify for an exemption to these limits as defined in the Annexes of Directive 2000/53/EC (ELV). Regarding the REACH Regulation, the information TE provides on SVHC in articles for this part number is based on the latest European Chemicals Agency (ECHA) 'Guidance on requirements for substances in articles' posted at this URL: <https://echa.europa.eu/guidance-documents/guidance-on-reach>

Compatible Parts

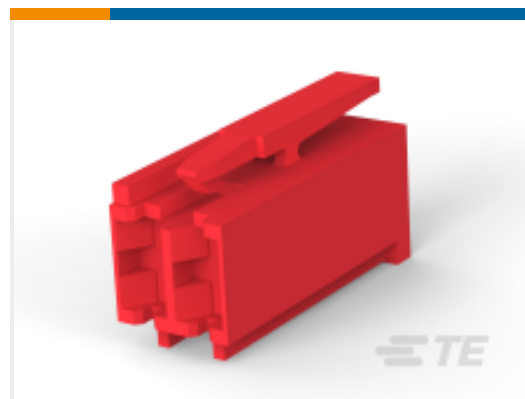

TE Part # 1-2178029-2
2P ST-TIMER RED, V0



TE Part # 8-1241983-2
STANDARD TIMER HOUSING MARK II



TE Part # 1-1241964-1
11POS STANDARD TIMER HOUSING



TE Part # 964768-3
STD-TIM HSG SPECIAL 2P (NATURE)



TE Part # 1-1955422-7
STD TIM MK2 GEH 3P, V0



TE Part # 2-2178029-2
2P ST-TIMER HSG BLACK, V0



TE Part # 2-2178029-5
STD TIMER GEH 5P_V0



TE Part # 2178600-2
STD TIMER HOUSING 2POS

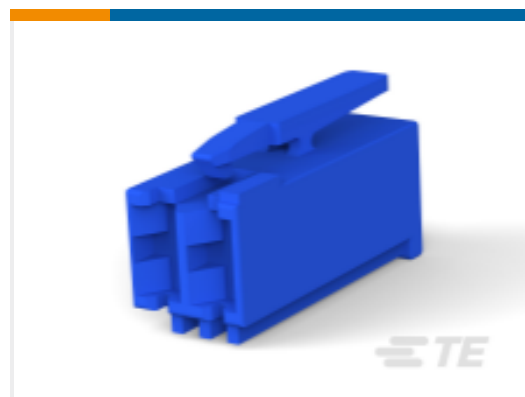

TE Part # 3-2178600-2
STD TIMER HOUSING 2P BLUE

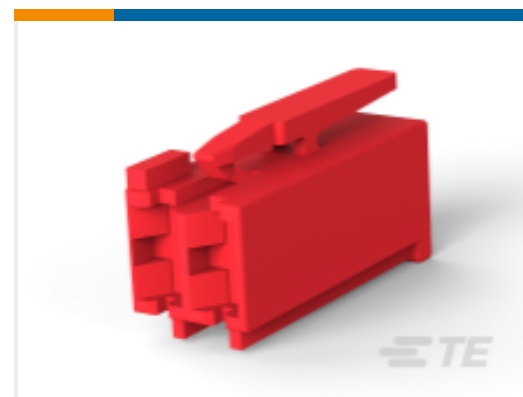

TE Part # 4-2178600-2
STD TIMER HOUSING 2P RED

Also in the Series | RAST 5D



Automotive Terminals(5)

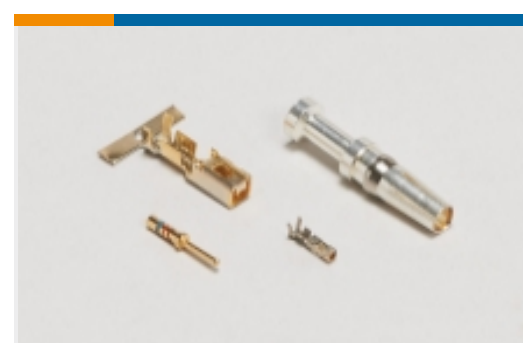

Connector Contacts(10)



Insertion & Extraction Tools(1)

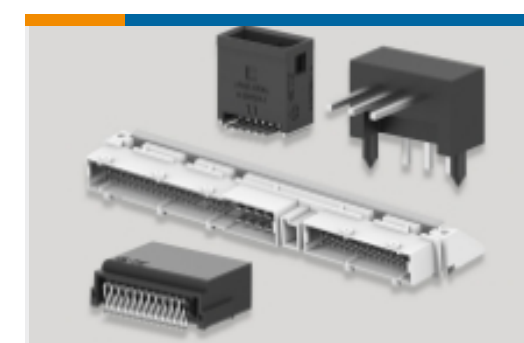

PCB Headers & Receptacles(69)



Wire-to-Board Connector Assemblies & Housings(88)

Customers Also Bought

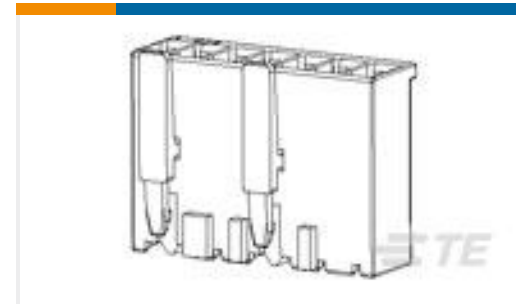
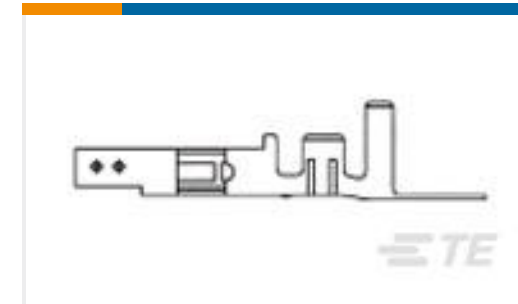
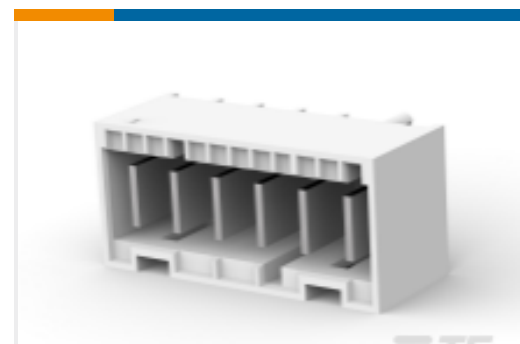
TE Part #1-1871468-2
DYNAMIC 1200S HDR ASSY V 2P X
BLACK GOLDTE Part #2-1241959-4
STD TIM HOUSING MKII 4POSTE Part #5-928247-2
2P ST-TIMER GEHTE Part #794956-1
VAL-U-LOK SKT BR SN 22-18AWGTE Part #2232532-2
2P, PL RAST 5 Tab Header, TH, VerticalTE Part #1-2232532-6
6P, PL RAST 5 Tab Header, TH, VerticalTE Part #2232532-4
4P, PL RAST 5 Tab Header, TH, VerticalTE Part #521204-7
RAST 5, HSG, 2P, POSILOCK MKIII

Documents

Product Drawings

[2POS STANDARD TIMER HOUSING_BLACK](#)

English

CAD Files

[3D PDF](#)

3D

Customer View Model

[ENG_CVM_CVM_5-2178600-2_A1.2d_dxf.zip](#)

English

Customer View Model

[ENG_CVM_CVM_5-2178600-2_A1.3d_igs.zip](#)

English

Customer View Model

[ENG_CVM_CVM_5-2178600-2_A1.3d_stp.zip](#)

English

By downloading the CAD file I accept and agree to the [Terms and Conditions](#) of use.



Product Specifications

Product Specification

German

Agency Approvals

Agency Approval Document

English

X-ON Electronics

Largest Supplier of Electrical and Electronic Components

Click to view similar products for [Headers & Wire Housings](#) category:

Click to view products by [TE Connectivity](#) manufacturer:

Other Similar products are found below :

[0015917161](#) [0022155065](#) [57102-F02-18ULF](#) [58102-G61-06LF](#) [582553-1](#) [01.001.5753.1](#) [0050291907](#) [02.125.8002.8](#) [609-3404](#) [61062-3](#)
[CSU011177004](#) [622-0430](#) [622-3653LF](#) [63453-116](#) [636-1030](#) [636-1427](#) [636-3427](#) [636-4007](#) [641938-9](#) [65495-038](#) [65692-001LF](#) [65781-018](#)
[65781-047](#) [65817-010LF](#) [65817-015LF](#) [67095-007LF](#) [67601157](#) [68631-112](#) [68645-018](#) [699319-000](#) [70.362.1628.0](#) [70-4210](#) [70-4226B](#) [70-](#)
[4853B](#) [71.350.2428.0](#) [733-134](#) [733-162](#) [760-3052](#) [MHR-64-VUAL](#) [80.063.4001.1](#) [800-90-001-10-001000](#) [801-43-002-10-013000](#)
[801-43-006-10-002000](#) [803-43-024-10-001000](#) [803-93-012-10-001000](#) [8-1437020-4](#) [819-22-004-30-001101](#) [820-22-006-30-001101](#)
[820-22-008-30-001101](#) [821-22-002-10-001101](#)