

| LOC | | DIST | | REVISIONS | | | |
|-----|-----|---------------------------|-----------|-----------|------|--|--|
| P | LTN | DESCRIPTION | DATE | DWN | APVD | | |
| C | | REVISED PER ECR-21-100678 | 08APR2021 | SS | VS | | |

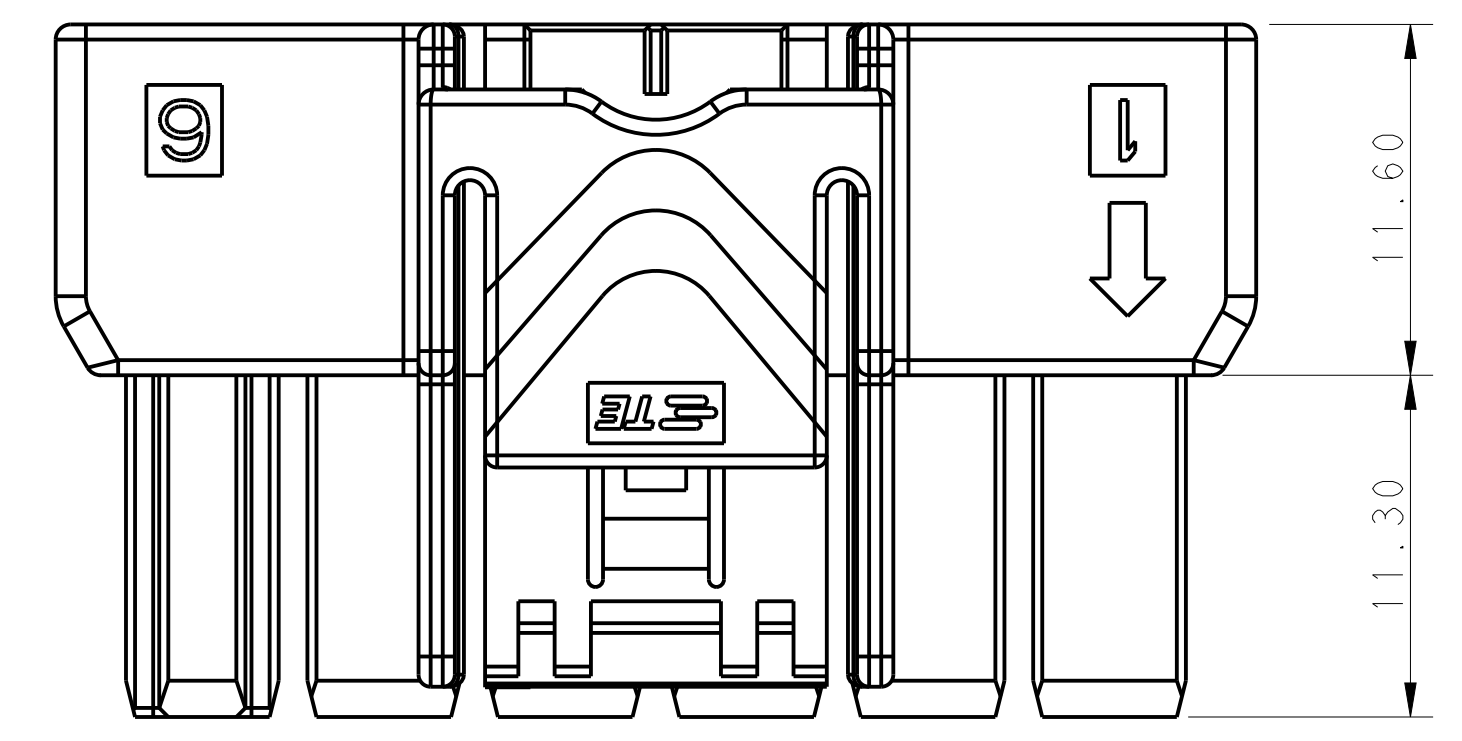

| POS. | DIM. A |
|------|--------|
| 2*6 | 39.70 |
| 2*5 | 33.70 |
| 2*4 | 27.70 |
| 2*3 | 21.70 |

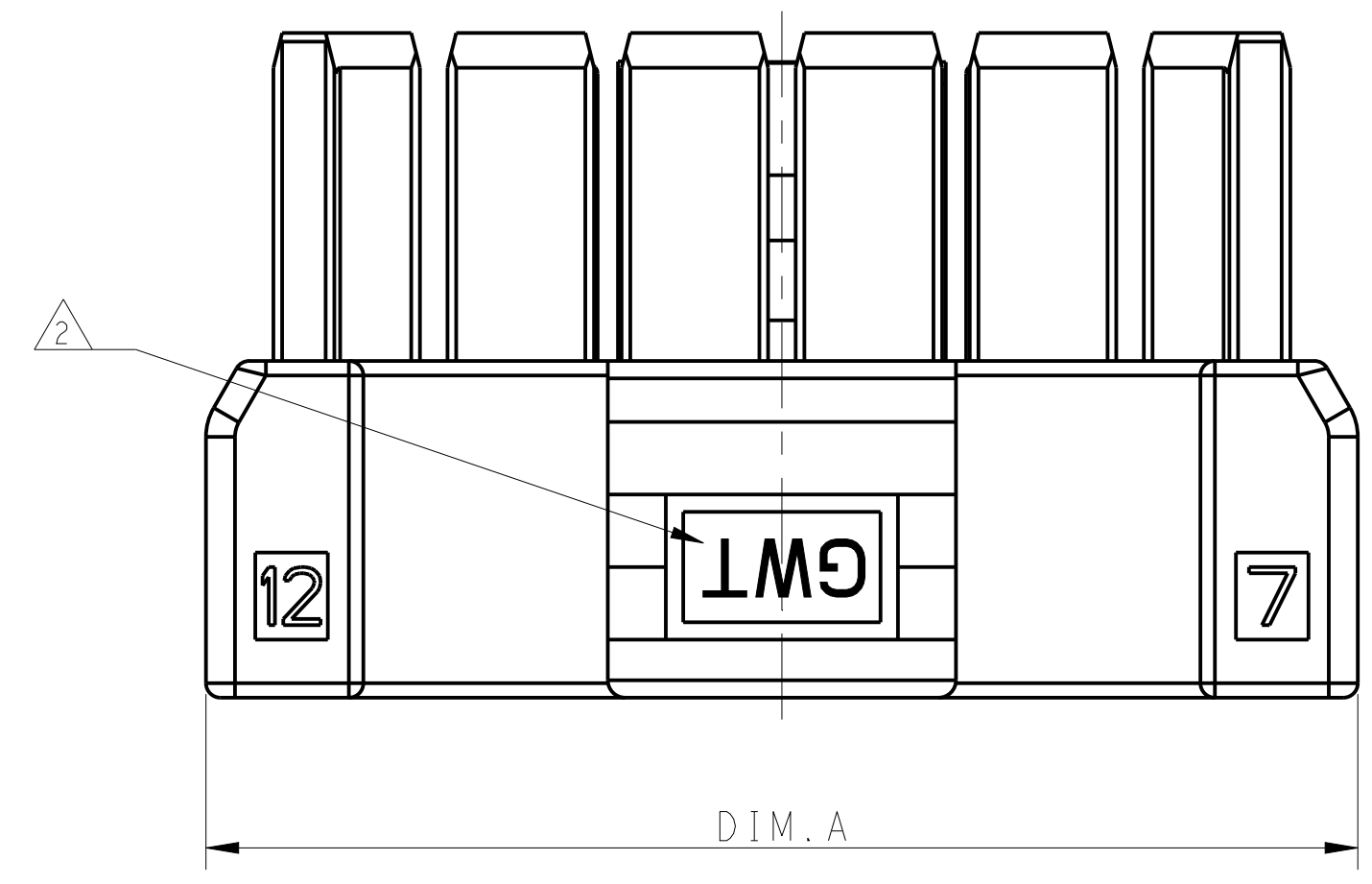
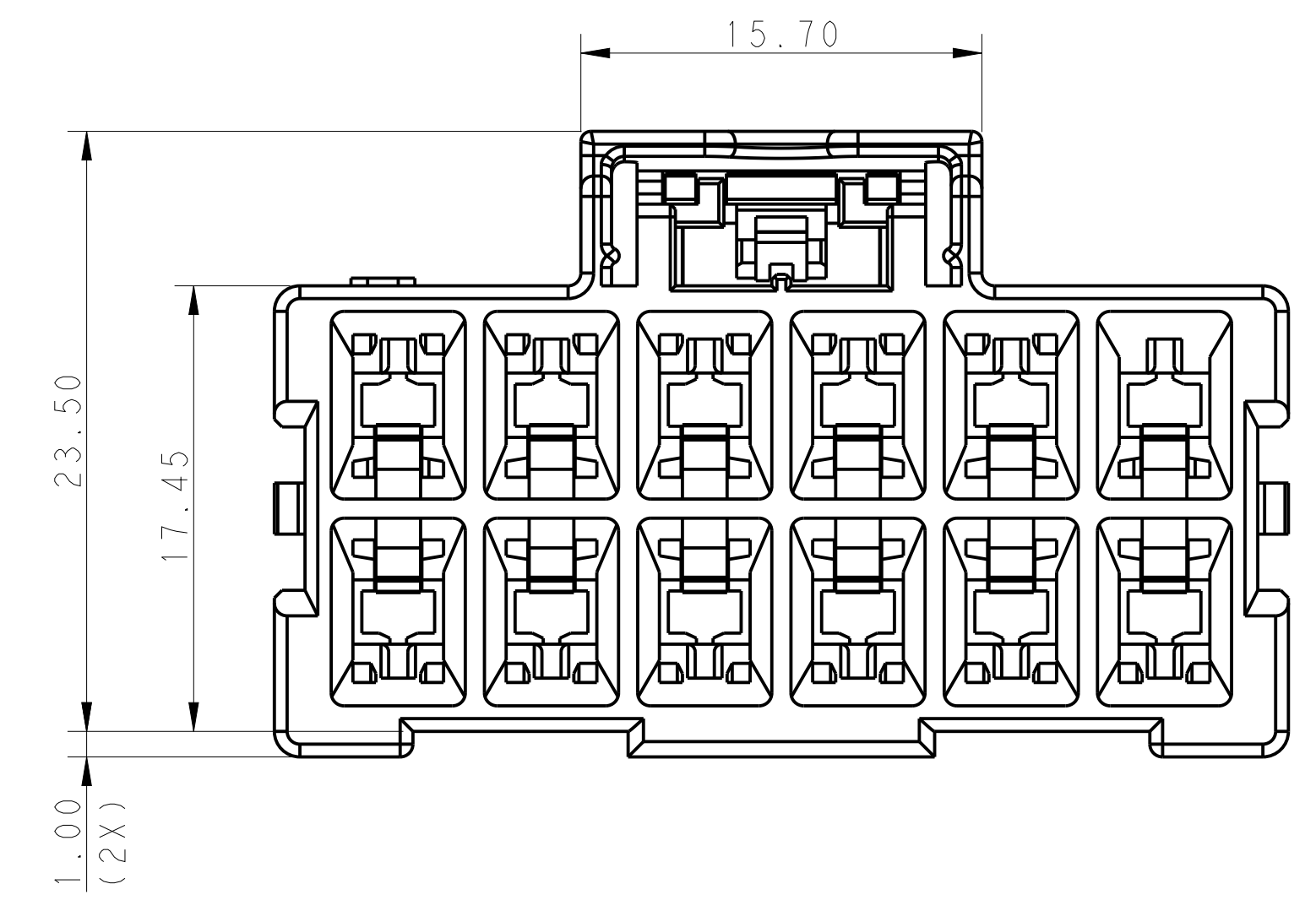
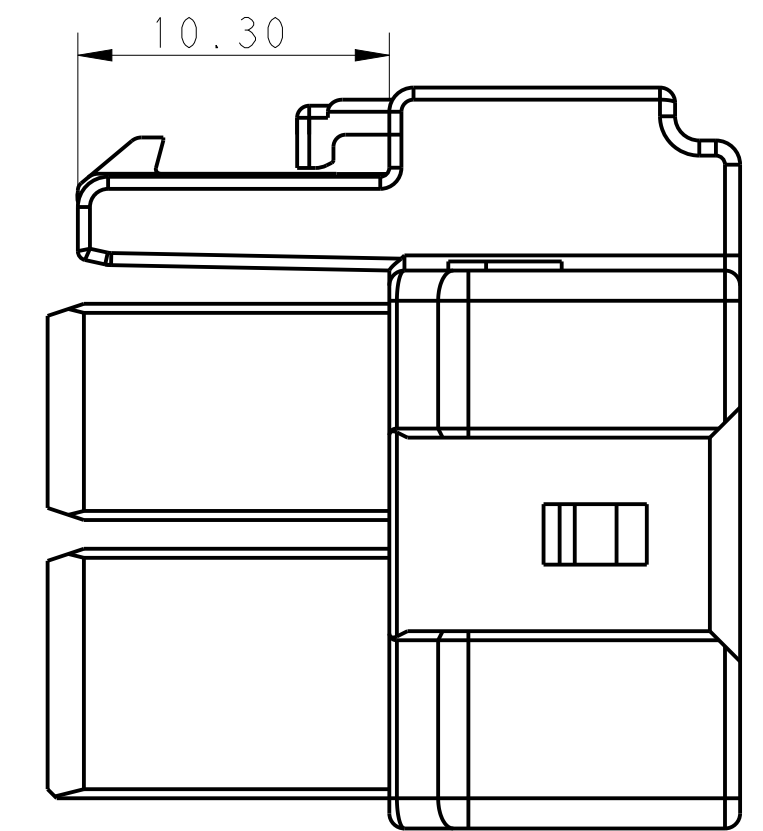
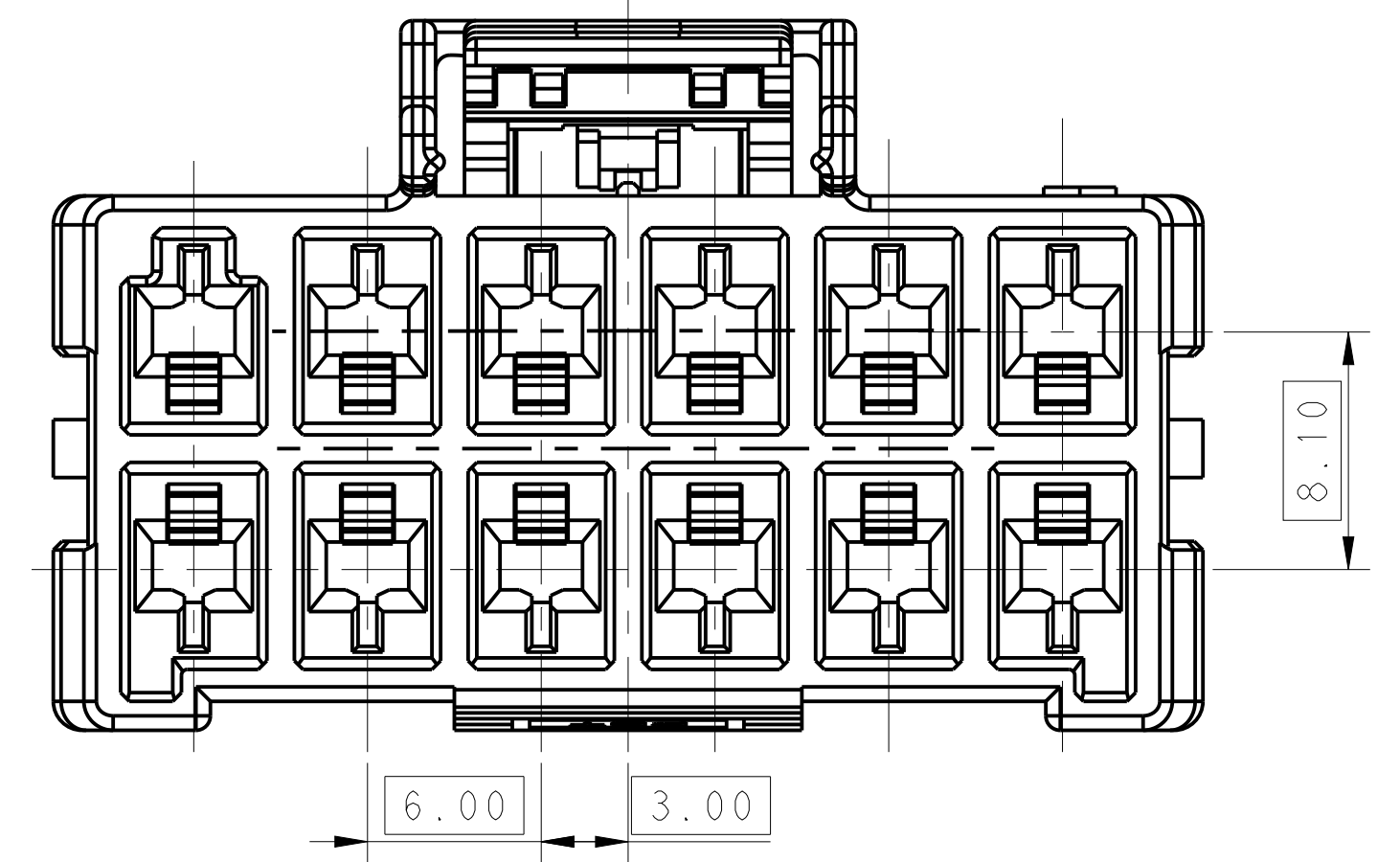

NOTE

- MATERIAL:
 - LEVEL A: PA6, COMPLY WITH GLOW WIRE REQUIREMENTS FOR PARTS OF NON-METALLIC MATERIAL SUPPORTING A CURRENT-CARRYING CONNECTION DETAILED IN IEC 60335-1, SECTION 30 (GWT), UL 94V-0
 - LEVEL B: PBT, HOT WIRE IGNITION (HWI) VERSION ARE MOLDED IN A RESIN THAT COMPLIES WITH TE PENDING HOT WIRE IGNITION TEST AND ARE RECOMMENDED FOR USE WITH HWI HOUSINGS THAT ALSO COMPLY, UL 94V-0

- MATERIAL MARK:
 - LEVEL A:GWT,LEVEL B:HWT

- APPLICABLE CONTACT P/N
 RECEPTACLE CONTACT: 1971237/1971779/81/83/85/87-*, 2238066-*

- MATING CONN, P/N
 CAP HSG: *-2232359/264-
 TPA: *-1971778-*

| | | | | | |
|--|--|----------------------------|--|--|--|
| THIS DRAWING IS A CONTROLLED DOCUMENT. | | DWG: TOMMY WU 26MAR2013 | | TE Connectivity | |
| DIMENSIONS: mm | | CHK: HAPYE WU 26MAR2013 | | | |
| TOLERANCES UNLESS OTHERWISE SPECIFIED: | | APVD: YIHONG MAO 26MAR2013 | | NAME: PLUG HOUSING, DOUBLE ROW POWER TRIPLE LOCK | |
| 0 PLC ± | | PRODUCT SPEC | | SIZE: A1 | |
| 1 PLC ±0.35 | | 108-106118 | | CAGE CODE: 2232266 | |
| 2 PLC ±0.25 | | APPLICATION SPEC | | RESTRICTED TO | |
| 3 PLC ± | | 114-106118 | | SCALE: - | |
| 4 PLC ± | | WEIGHT: - | | SHEET 1 OF 2 | |
| ANGLES ± | | Customer Drawing | | REV C | |

| LOC | | DIST | | REVISIONS | | | |
|-----|-----|-------------|------|-----------|------|---|---|
| P | LTN | DESCRIPTION | DATE | DNW | APVD | | |
| - | - | SEE SHEET 1 | - | - | - | - | - |

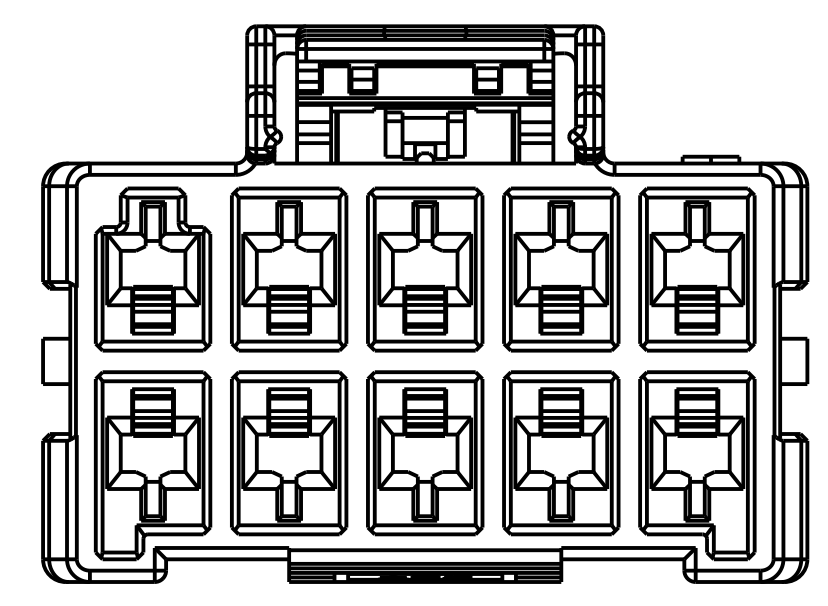
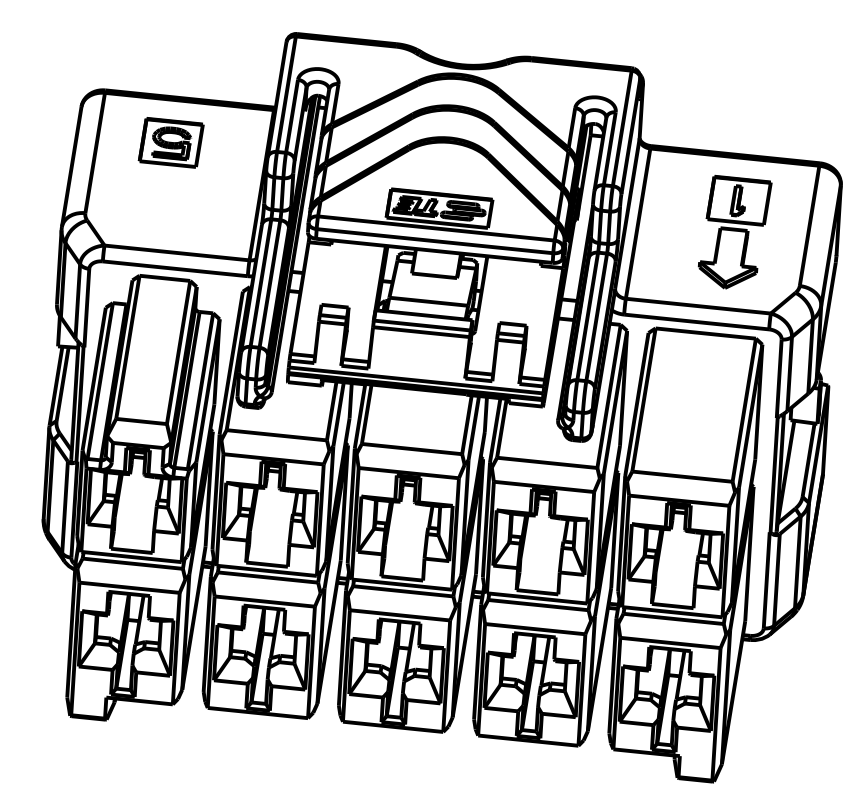

2*5 POSITIONS

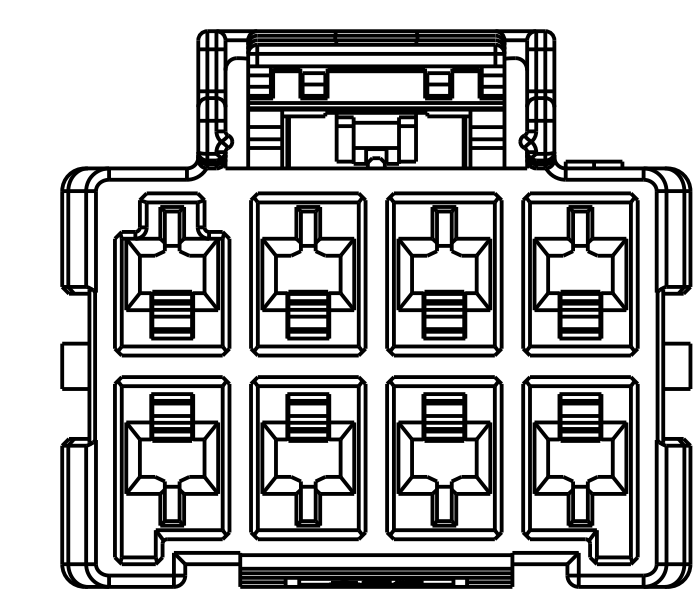
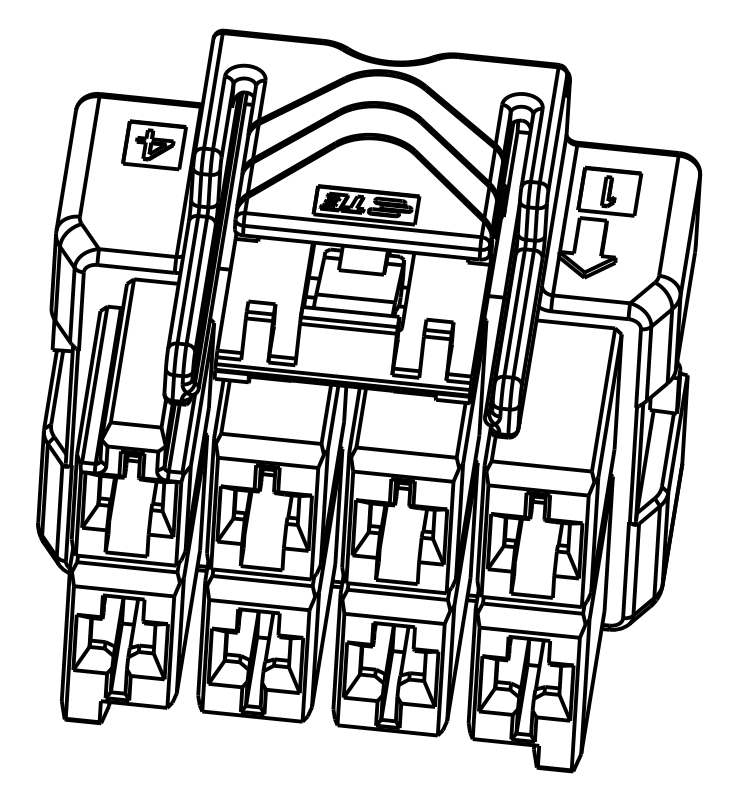

2*4 POSITIONS

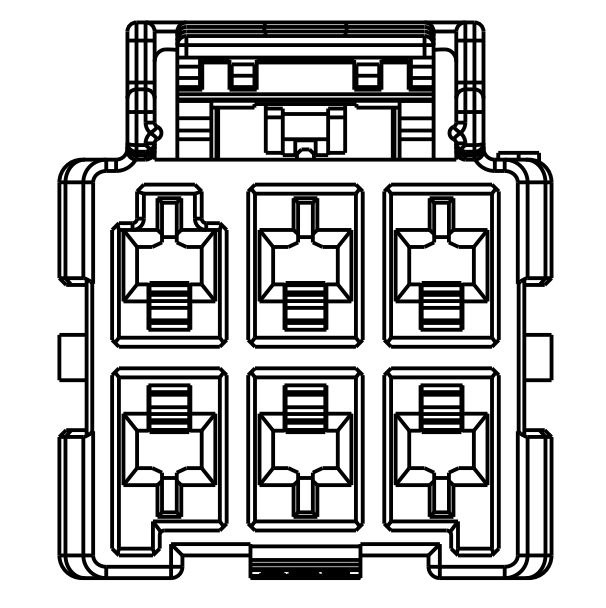
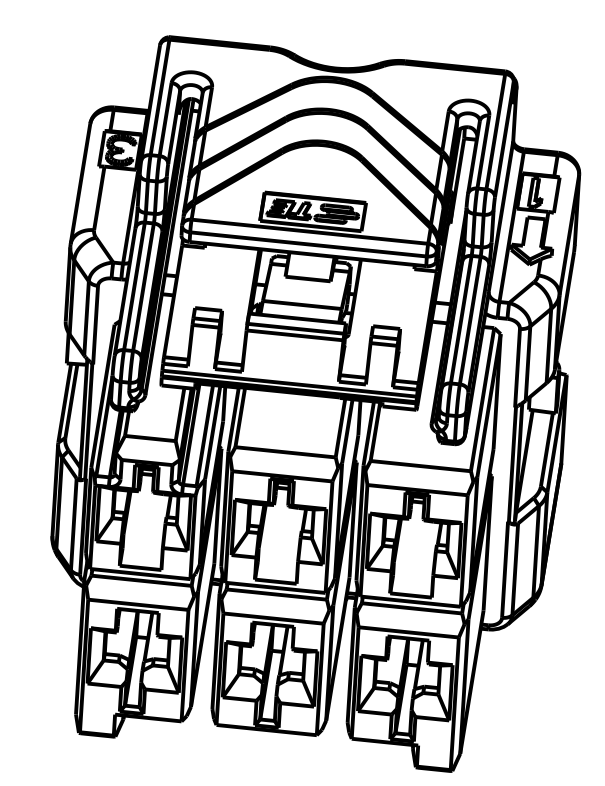

2*3 POSITIONS

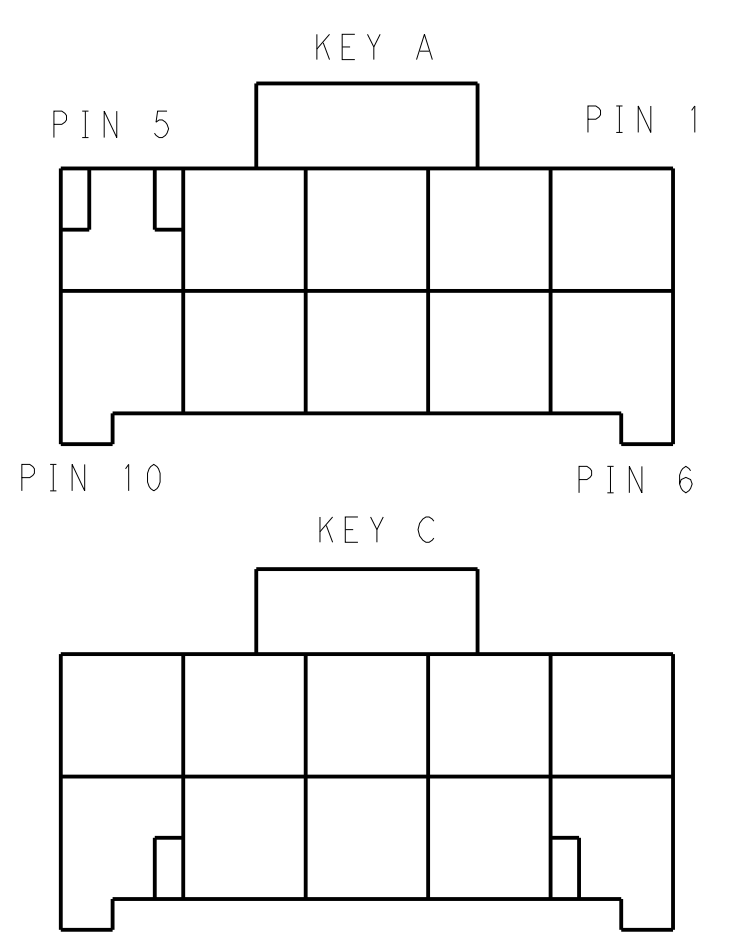

KEYING FOR 2*5 POS.

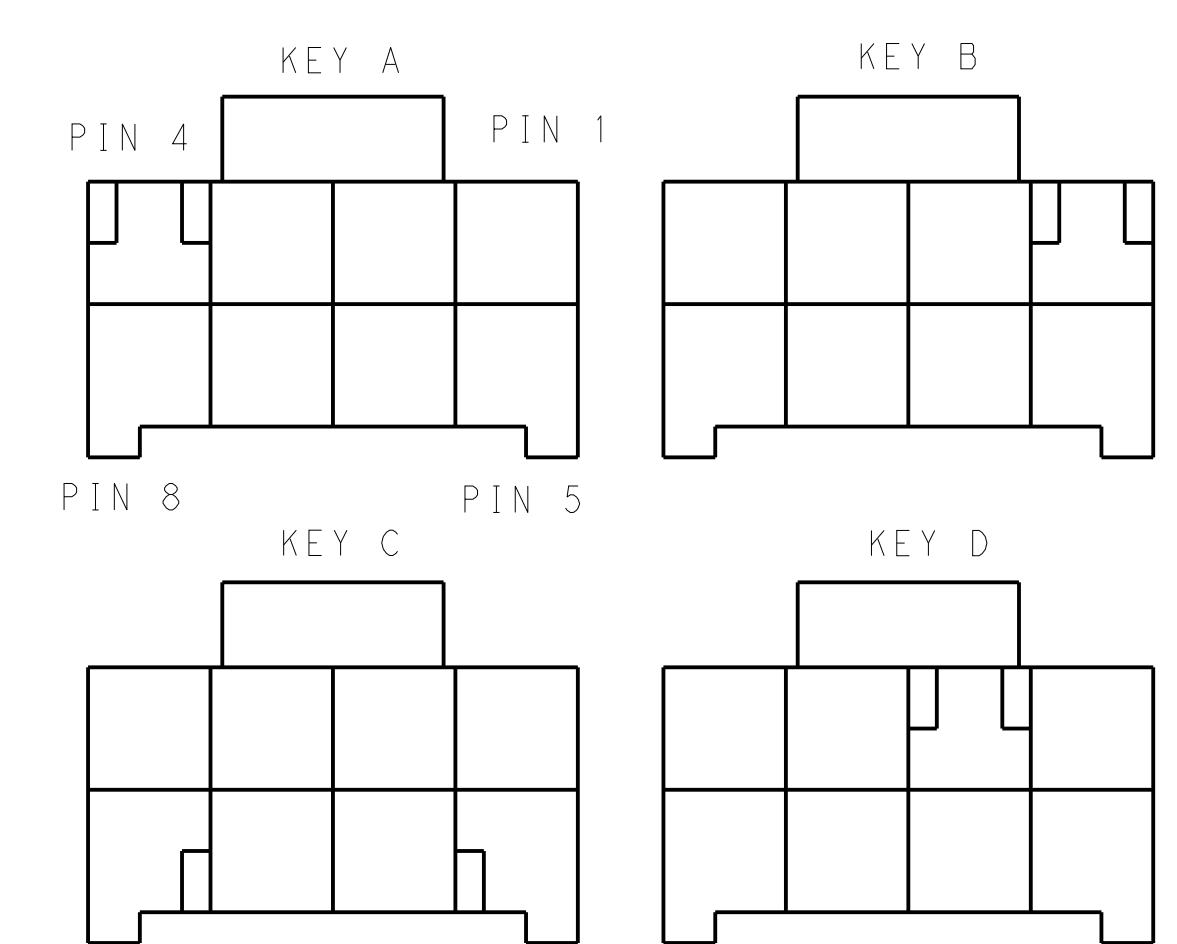

KEYING FOR 2*4 POS.

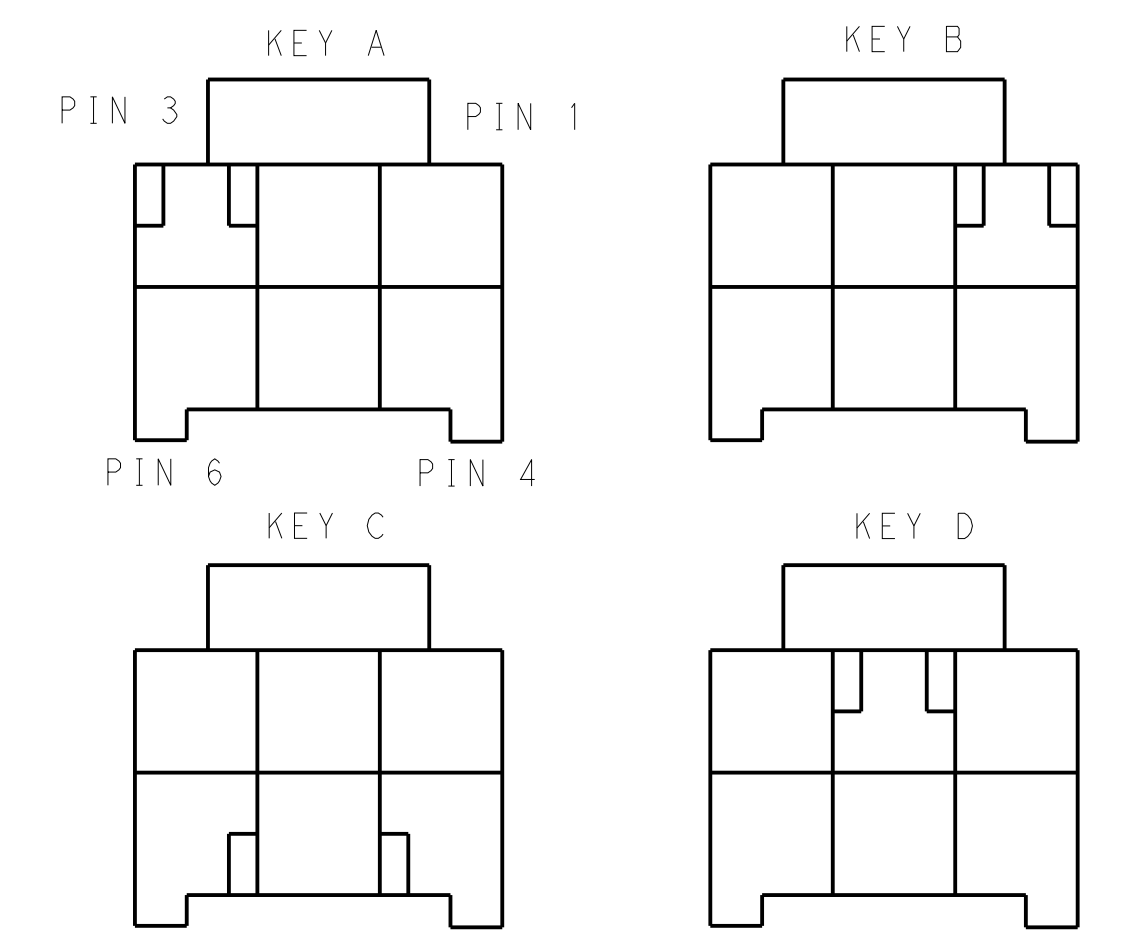

KEYING FOR 2*3 POS.

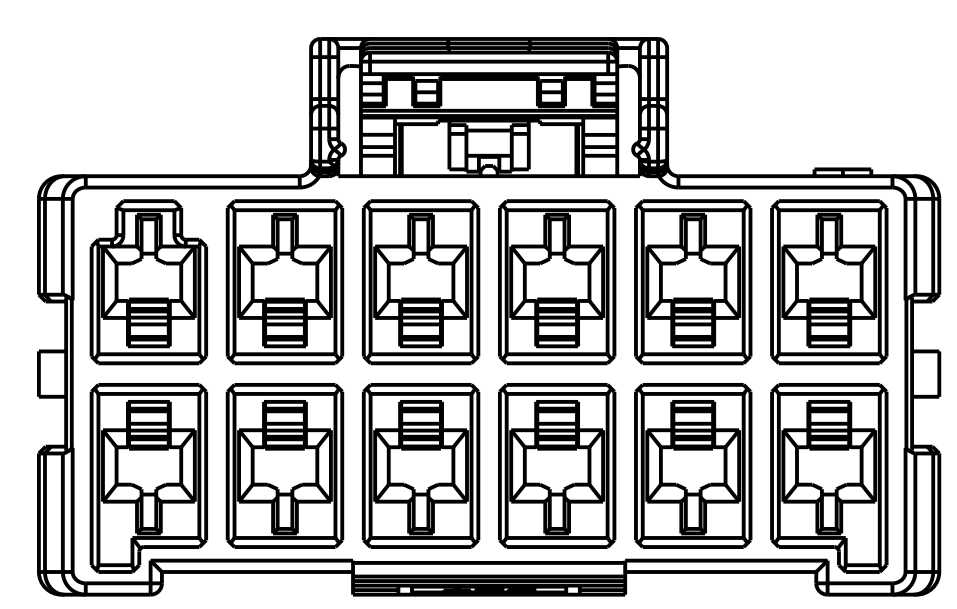
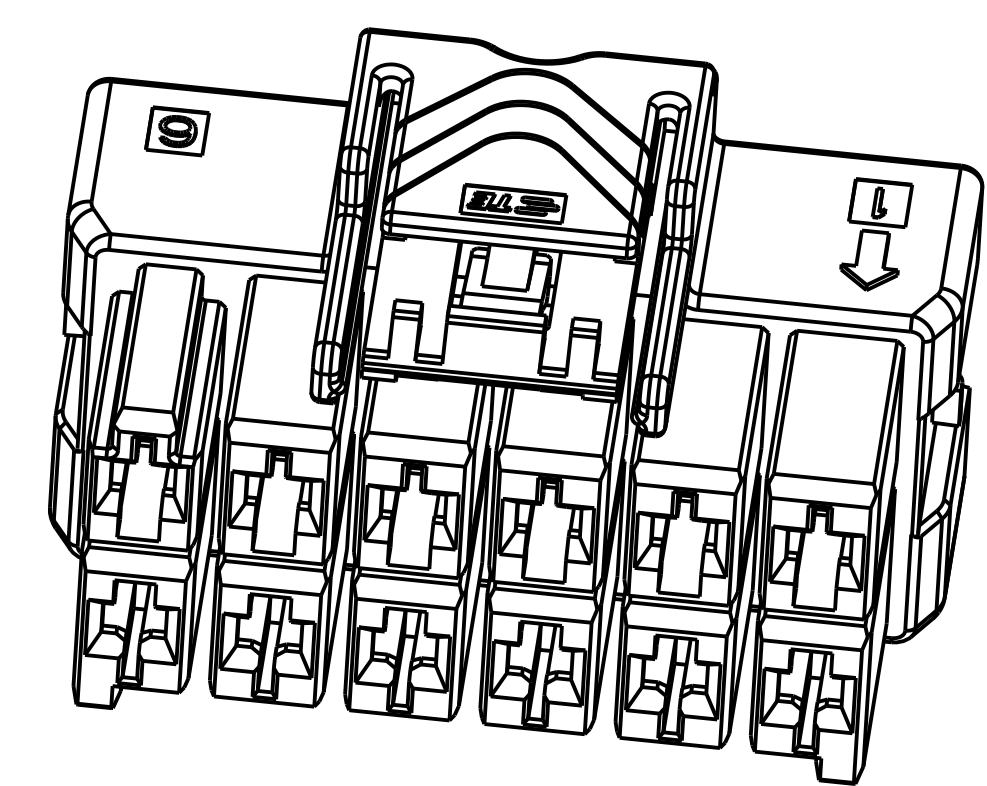

2*6 POSITIONS

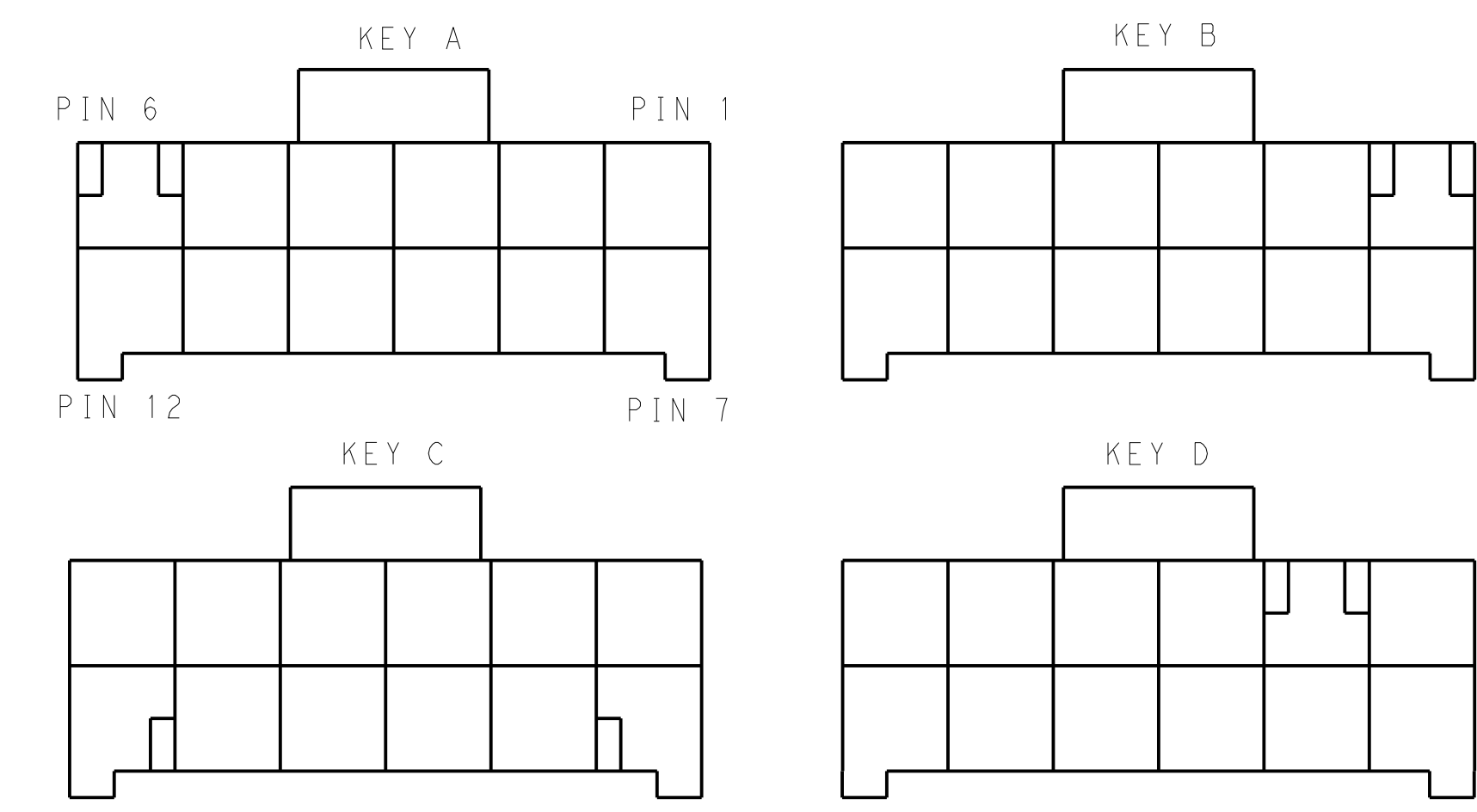

KEYING FOR 2*6 POS.

| POS. | MATERIAL | COLOR | KEY | P/N |
|------|----------|-----------|-------|-------------|
| 2*6 | LEVEL A | DARK GREY | KEY A | 5-2232266-6 |
| | | BROWN | KEY B | 6-2232266-6 |
| | | GREEN | KEY C | 7-2232266-6 |
| | | ORANGE | KEY D | 8-2232266-6 |
| 2*5 | LEVEL A | DARK GREY | KEY A | 5-2232266-5 |
| | | BROWN | KEY B | 6-2232266-5 |
| | | GREEN | KEY C | 7-2232266-5 |
| | | ORANGE | KEY D | 8-2232266-5 |

| POS. | MATERIAL | COLOR | KEY | P/N |
|---------|----------|-----------|-------|-------------|
| 2*4 | LEVEL A | DARK GREY | KEY A | 5-2232266-4 |
| | | BROWN | KEY B | 6-2232266-4 |
| | | GREEN | KEY C | 7-2232266-4 |
| | | ORANGE | KEY D | 8-2232266-4 |
| 2*3 | LEVEL A | DARK GREY | KEY A | 5-2232266-3 |
| | | BROWN | KEY B | 6-2232266-3 |
| | | GREEN | KEY C | 7-2232266-3 |
| | | ORANGE | KEY D | 8-2232266-3 |
| LEVEL B | KEY A | BLACK | KEY A | 1-2232266-1 |

THIS DRAWING IS A CONTROLLED DOCUMENT.

DIMENSIONS: mm
 0 PLC ±0.35
 1 PLC ±0.25
 2 PLC ±0.25
 3 PLC ±0.25
 4 PLC ±0.25
 ANGLES ±0.5

TOLERANCES UNLESS OTHERWISE SPECIFIED:
 DIMENSIONS: mm
 0 PLC ±0.35
 1 PLC ±0.25
 2 PLC ±0.25
 3 PLC ±0.25
 4 PLC ±0.25
 ANGLES ±0.5

MATERIAL: -
 FINISH: -
 WEIGHT: -
 CUSTOMER DRAWING: -

DWN: TOMMY_WU 26MAR2013
 CHK: HAPYE_WU 26MAR2013
 APVD: YUJHONG_MAO 26MAR2013
 PRODUCT SPEC: 108-106118
 APPLICATION SPEC: 114-106118

NAME: PLUG HOUSING, DOUBLE ROW POWER TRIPLE LOCK
 SIZE: A1
 CAGE CODE: 00779
 DRAWING NO: C=2232266
 SHEET 2 OF 2
 REV C

THIS DRAWING IS UNPUBLISHED. RELEASED FOR PUBLICATION. ALL RIGHTS RESERVED.

X-ON Electronics

Largest Supplier of Electrical and Electronic Components

Click to view similar products for [Headers & Wire Housings](#) category:

Click to view products by [TE Connectivity](#) manufacturer:

Other Similar products are found below :

[892-18-020-10-001101](#) [58102-G61-06LF](#) [582553-1](#) [0009485154](#) [009176003701906](#) [0050291907](#) [LY20-4P-DT1-P1E-BR](#) [02.125.8002.8](#)
[609-3404](#) [61062-3](#) [61082-181009](#) [622-3653LF](#) [63453-116](#) [636-1030](#) [636-1427](#) [636-3427](#) [636-4007](#) [641938-9](#) [641991-4](#) [644827-2](#) [65817-](#)
[010LF](#) [65817-015LF](#) [65863-015LF](#) [66207-023LF](#) [67095-007LF](#) [67601157](#) [68645-018](#) [68648-049](#) [70.362.1628.0](#) [70-4210](#) [70-4226B](#) [70-](#)
[4853B](#) [707-5020](#) [707-5028](#) [71.350.2428.0](#) [71918-208LF](#) [71961-016LF](#) [733-134](#) [733-162](#) [754199-000](#) [760-3052](#) [787-8014-00](#) [79531-3000](#)
[FCN-360C032-B](#) [FCN-367T-T012/H](#) [FCN-723D010/2](#) [80.063.4001.1](#) [800-90-001-10-001000](#) [800-90-010-10-002000](#) [801-43-002-10-013000](#)