

**Mod IV Receptacle Assemblies, Single-Row, Outrigger Design  
.100 x .100 [2.54 x 2.54] Centerline, End To End Stackable**

**Dual Entry, End Stackable,  
Low Profile, .100 x .100  
[2.54 x 2.54] Centerline,  
.200 [5.08] Tine Spacing**



**Material and Finish**

**Housing** — Glass-filled thermoplastic, black, 94V-0 rated

**Plating A** — Duplex .000030 [0.00076] gold on contact area, .000150-.000300 [0.00381-0.00762] matte tin on solder area all over .000050 [0.00127] nickel

**Plating B** — Duplex .000010 [0.000254] gold on contact area, .000150-.000300 [0.00381-0.00762] matte tin on solder area all over .000050 [0.00127] nickel

**Plating C** — .000150-.000300 [0.00381-0.00762] matte tin on solder leads, all over .000050 [0.00127] nickel



**Recommended PC Board Hole Layout**

No. of Pos.	Dimensions		Contact Plating/Part Nos.		
	A	B	Plating A	Plating B	Plating C
3	.300 [7.62]	.200 [5.08]	5-147720-2	5-147726-2	5-147727-2
4	.400 [10.16]	.300 [7.62]	5-147720-3	5-147726-3	5-147727-3
5	.500 [12.70]	.400 [10.16]	5-147720-4	5-147726-4	5-147727-4
6	.600 [15.24]	.500 [12.70]	5-147720-5	5-147726-5	5-147727-5
7	.700 [17.78]	.600 [15.24]	5-147720-6	5-147726-6	5-147727-6
8	.800 [20.32]	.700 [17.78]	5-147720-7	5-147726-7	5-147727-7
9	.900 [22.86]	.800 [20.32]	5-147720-8	5-147726-8	5-147727-8
10	1.000 [25.40]	.900 [22.86]	5-147720-9	5-147726-9	5-147727-9
11	1.100 [27.94]	1.000 [25.40]	6-147720-0	6-147726-0	6-147727-0
12	1.200 [30.48]	1.100 [27.94]	6-147720-1	6-147726-1	6-147727-1
13	1.300 [33.02]	1.200 [30.48]	6-147720-2	6-147726-2	6-147727-2
14	1.400 [35.56]	1.300 [33.02]	6-147720-3	6-147726-3	6-147727-3
15	1.500 [38.10]	1.400 [35.56]	6-147720-4	6-147726-4	6-147727-4
16	1.600 [40.64]	1.500 [38.10]	6-147720-5	6-147726-5	6-147727-5
17	1.700 [43.18]	1.600 [40.64]	6-147720-6	6-147726-6	6-147727-6
18	1.800 [45.72]	1.700 [43.18]	6-147720-7	6-147726-7	6-147727-7
19	1.900 [48.26]	1.800 [45.72]	6-147720-8	6-147726-8	6-147727-8
20	2.000 [50.80]	1.900 [48.26]	7-147720-8	7-147726-8	7-147727-8
30	3.000 [76.20]	2.900 [73.66]	8-147720-8	8-147726-8	8-147727-8
40	4.000 [101.60]	3.900 [99.06]	8-147720-9	8-147726-9	8-147727-9

- Notes:** 1. Tyco Electronics recommends mating gold or duplex plated headers with duplex plated receptacle assemblies.  
2. To obtain the minimum mating post length, add .020 [0.51] (not including the post lead in chamfer) to the maximum point-of-contact dimension and add .062 [1.57] for recommended board thickness if used in bottom entry application.

**Note:** All part numbers are RoHS compliant.



**Mod. IV Receptacle Assemblies, Double-Row, .100 x .100 [2.54 x 2.54] Centerline**

**Closed Dual Entry, Side and End Stackable Low Profile, .100 x .100 [2.54 x 2.54] Centerline, .150 [3.81] Tine Spacing**

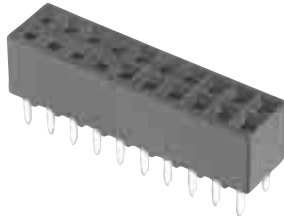

**Material and Finish**

**Housing** — Glass-filled thermoplastic, black, 94V-0 rated

**Contacts** — Phosphor bronze, plated as follows:

**Plating A** — Duplex .000030 [0.00076] gold on contact area, .000150-.000300 [0.00381-0.00762] matte tin on solder area all over .000050 [0.00127] nickel

**Plating B** — Duplex .000010 [0.000254] gold on contact area, .000150-.000300 [0.00381-0.00762] matte tin on solder area all over .000050 [0.00127] nickel

**Plating C** — .000150-.000300 [0.00381-0.00762] matte tin on solder leads, all over .000050 [0.00127] nickel



**Recommended PC Board Hole Layout for Bottom Entry or Pass Through Applications**

\*±.003 [±0.08] tolerances not to accumulate within one connector pattern.

**Recommended PC Board Hole Layout for Top Entry**

**Related Product Data**

**Mateable Headers** — Refer to the Mating Post Selection Guide — page 90

**Performance Characteristics** — page 174

**Technical Documents** — page 276

**Product Specification** 108-25022

**Application Specification** 114-25018

No. of Pos.	Dimensions		Contact Plating/Part Nos.		
	A	B	Plating A	Plating B	Plating C
2	.100 [2.54]	—	5-535542-1	5-147095-1	5-147096-1
4	.200 [5.08]	.100 [2.54]	5-535542-2	5-147095-2	5-147096-2
6	.300 [7.62]	.200 [5.08]	5-535542-3	5-147095-3	5-147096-3
8	.400 [10.16]	.300 [7.62]	5-535542-4	5-147095-4	5-147096-4
10	.500 [12.70]	.400 [10.16]	5-535542-5	5-147095-5	5-147096-5
12	.600 [15.24]	.500 [12.70]	5-535542-6	5-147095-6	5-147096-6
14	.700 [17.78]	.600 [15.24]	5-535542-7	5-147095-7	5-147096-7
16	.800 [20.32]	.700 [17.78]	5-535542-8	5-147095-8	5-147096-8
18	.900 [22.86]	.800 [20.32]	5-535542-9	5-147095-9	5-147096-9
20	1.000 [25.40]	.900 [22.86]	6-535542-0	6-147095-0	6-147096-0
22	1.100 [27.94]	1.000 [25.40]	6-535542-1	6-147095-1	6-147096-1
24	1.200 [30.48]	1.100 [27.94]	6-535542-2	6-147095-2	6-147096-2
26	1.300 [33.02]	1.200 [30.48]	6-535542-3	6-147095-3	6-147096-3
28	1.400 [35.56]	1.300 [33.02]	6-535542-4	6-147095-4	6-147096-4
30	1.500 [38.10]	1.400 [35.56]	6-535542-5	6-147095-5	6-147096-5
32	1.600 [40.64]	1.500 [38.10]	6-535542-6	6-147095-6	6-147096-6
34	1.700 [43.18]	1.600 [40.64]	6-535542-7	6-147095-7	6-147096-7
36	1.800 [45.72]	1.700 [43.18]	6-535542-8	6-147095-8	6-147096-8
38	1.900 [48.26]	1.800 [45.72]	6-535542-9	6-147095-9	6-147096-9
40	2.000 [50.80]	1.900 [48.26]	7-535542-0	7-147095-0	7-147096-0

**Notes:** 1. Tyco Electronics recommends mating gold or duplex plated headers with duplex plated receptacle assemblies.  
2. To obtain the minimum mating post length, add .020 [0.51] (not including the post lead in chamfer) to the maximum point-of-contact dimension, and .062 [1.57] for recommended board thickness if used in bottom entry application.

**Note:** All part numbers are RoHS compliant.

### Mod. IV Receptacle Assemblies, Double-Row, .100 x .100 [2.54 x 2.54] Centerline (Continued)

No. of Pos.	Dimensions		Contact Plating/Part Nos.		
	A	B	Plating A	Plating B	Plating C
42	2.100 [53.34]	2.000 [50.80]	7-535542-1	7-147095-1	7-147096-1
44	2.200 [55.88]	2.100 [53.34]	7-535542-2	7-147095-2	7-147096-2
46	2.300 [58.42]	2.200 [55.88]	7-535542-3	7-147095-3	7-147096-3
48	2.400 [60.96]	2.300 [58.42]	7-535542-4	7-147095-4	7-147096-4
50	2.500 [63.50]	2.400 [60.96]	7-535542-5	7-147095-5	7-147096-5
52	2.600 [66.04]	2.500 [63.50]	7-535542-6	7-147095-6	7-147096-6
54	2.700 [68.58]	2.600 [66.04]	7-535542-7	7-147095-7	7-147096-7
56	2.800 [71.12]	2.700 [68.58]	7-535542-8	7-147095-8	7-147096-8
58	2.900 [73.66]	2.800 [71.12]	7-535542-9	7-147095-9	7-147096-9
60	3.000 [76.20]	2.900 [73.66]	8-535542-0	8-147095-0	8-147096-0
62	3.100 [78.74]	3.000 [76.20]	8-535542-1	8-147095-1	8-147096-1
64	3.200 [81.28]	3.100 [78.74]	8-535542-2	8-147095-2	8-147096-2
66	3.300 [83.82]	3.200 [81.28]	8-535542-3	8-147095-3	8-147096-3
68	3.400 [86.36]	3.300 [83.82]	8-535542-4	8-147095-4	8-147096-4
70	3.500 [88.90]	3.400 [86.36]	8-535542-5	8-147095-5	8-147096-5
72	3.600 [91.44]	3.500 [88.90]	8-535542-6	8-147095-6	8-147096-6
74	3.700 [93.98]	3.600 [91.44]	8-535542-7	8-147095-7	8-147096-7
76	3.800 [96.52]	3.700 [93.98]	8-535542-8	8-147095-8	8-147096-8
78	3.900 [99.06]	3.800 [96.52]	8-535542-9	8-147095-9	8-147096-9
80	4.000 [101.60]	3.900 [99.06]	9-535542-0	9-147095-0	9-147096-0

**Note:** All part numbers are RoHS compliant.

## Mod IV Surface Mount Vertical Receptacle Assemblies, .100 x .100 [2.54 x 2.54] Centerline

### Product Facts

- Surface Mount Leads
- Contact Material: phosphor bronze
- High temperature, black thermoplastic housings, 94V-0 rated, capable of withstanding IR or vapor-phase reflow
- Gold/tin duplex plating for reliable mating interconnection and solder interface
- Metallic hold downs provide retention in the PC board prior to and during the reflow process ... and strain relief after soldering
- Hold downs provide for proper lead-to-pad registration
- Closed-entry receptacle housings provide lead-in ramp for positive mating
- Receptacle contacts employ dual cantilever beams for reliable connections
- Recognized under the Component Program of Underwriters Laboratories Inc.  File No. E28476
- Certified by Canadian Standards Association,  File No. LR 7189

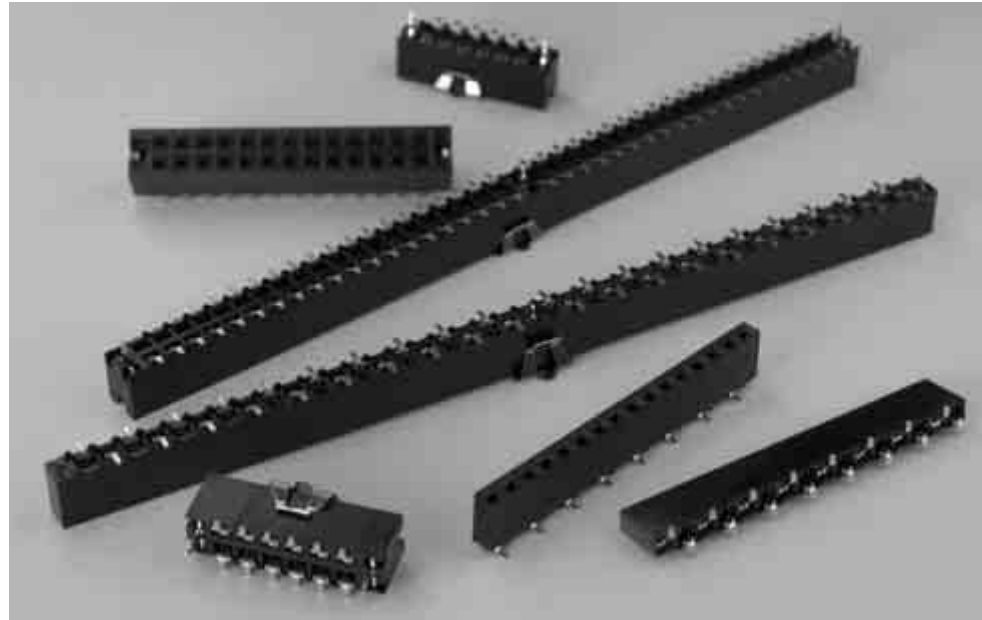

The AMPMODU 0.025 [0.64] square interconnection system is an industry standard that has provided level III and IV thru-hole interconnections to almost every industry and marketplace for years. As technology advances, so has the AMPMODU product line.

Surface mount vertical receptacle assemblies are available to meet your level II packaging needs as process technologies evolve from wave soldering to surface mount reflow (infrared and vapor-phase) processes. AMPMODU surface mount receptacle assemblies are offered in vertical dual entry configurations. These receptacles are available in single-row and double-row configurations with a contact centerline spacing of .100 x .100 [2.54 x 2.54].

AMPMODU surface mount vertical receptacle assemblies continue to provide the proven features and benefits of their thru-hole counterparts in the AMPMODU product family. Closed-entry style housing design provides a lead-in ramp for positive mating of contacts, virtually eliminating the possibility of stubbing. The dual-beam receptacle contact design, coupled with gold plating in the contact area, provides a reliable interface. Tin plating on the solder tails also enhances solderability.

The incorporation of compliant metallic hold downs on receptacle assemblies offers multiple benefits. The hold downs provide for proper lead-to-pad registration and provide retention to the PC board prior to and during processing. Used with a plated thru-hole, the hold

downs are soldered during the reflow process and serve as a strain relief for the solder joints during mating/unmating.

The design of the hold downs results in an excellent ratio of insertion/extraction forces (into the PC board); 20 lb. [89 N] maximum insertion force per pair and 10 lb. [44.5 N] minimum extraction force per pair (unsoldered). No tools are required for insertion.

---

**Mod IV Surface Mount Vertical Receptacle Assemblies,  
.100 x .100 [2.54 x 2.54] Centerline** (Continued)

---

**Performance Specifications****Voltage Rating:** 250 VAC**Current Rating:** 3.0 amperes (max.) for single contact;  
2.0 amperes (max.) per contact when connector is fully energized**Operating Temperature Range (Receptacle Assemblies):** -65°C to +125°C**Operating Temperature Range (Headers):** -65°C to +105°C**Dielectric Withstanding Voltage:** 750 VAC**Termination Resistance:** 12 milliohms (max.)**Insulation Resistance:** 5000 megohms (min.)**Mating Force (Receptacle Assemblies):** 9.0 oz. [2.50N] (max.) per contact**Unmating Force (Receptacle Assemblies):** 1.5 oz. [0.42N] (min.) per contact**Durability:** Tested to 200 cycles (min.) for .000030 [0.00076] gold plated contacts





**Mod IV Receptacle Assemblies, Single-Row, Surface Mount, .100 [2.54] x .100 [2.54] Centerline End To End Stackable without Compliant Pin Holdowns**

**Surface Mount, Single-Row, Dual Entry, End to End Stackable**

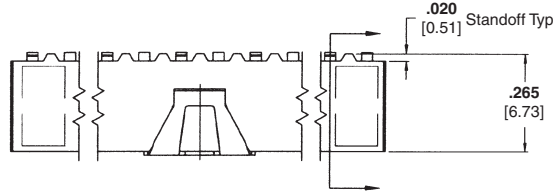

**Material and Finish**

**Housing** — Glass-filled thermoplastic, black, 94V-0 rated

**Contacts** — Phosphor bronze, plated as follows:

**Plating A** — Duplex .000030 [0.00076] gold on contact area, .000150-.000300 [0.00381-0.00762] matte tin on solder area all over .000050 [0.00127] nickel

**Plating B** — Duplex .000010 [0.000254] gold on contact area, .000150-.000300 [0.00381-0.00762] matte tin on solder area all over .000050 [0.00127] nickel

**Plating C** — .000150-.000300 [0.00381-0.00762] matte tin on solder leads, all over .000050 [0.00127] nickel

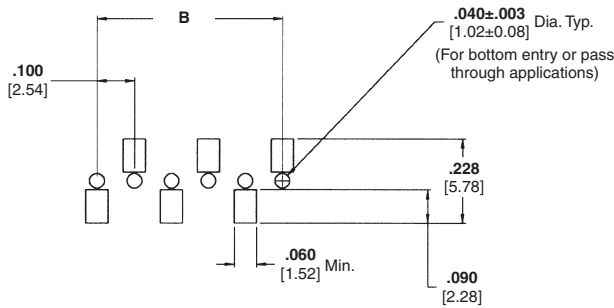
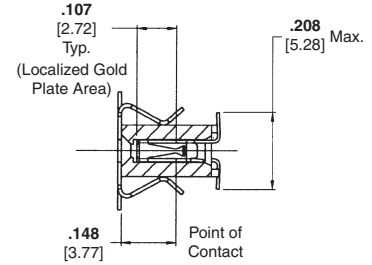

**Recommended PC Board Pad Pattern (.008 [0.20] thick stencil)**

**Related Product Data**

**Mateable Headers** — Refer to Mating Post Selection Guide — page 90

**Performance Specifications** — page 186

No. of Pos.	Dimensions		Packaged in Tubes			Packaged in Tape & Reel		
	A	B	Contact Plating/ Part Nos.			Contact Plating/ Part Nos.		
			Plating A	Plating B	Plating C	Plating A	Plating B	Plating C
3	.300 [7.62]	.200 [5.08]	5-147738-2	5-147737-2	5-147736-2	5-147723-2	5-147728-2	5-147729-2
4	.400 [10.16]	.300 [7.62]	5-147738-3	5-147737-3	5-147736-3	5-147723-3	5-147728-3	5-147729-3
5	.500 [12.70]	.400 [10.16]	5-147738-4	5-147737-4	5-147736-4	5-147723-4	5-147728-4	5-147729-4
6	.600 [15.24]	.500 [12.70]	5-147738-5	5-147737-5	5-147736-5	5-147723-5	5-147728-5	5-147729-5
7	.700 [17.78]	.600 [15.24]	5-147738-6	5-147737-6	5-147736-6	5-147723-6	5-147728-6	5-147729-6
8	.800 [20.32]	.700 [17.78]	5-147738-7	5-147737-7	5-147736-7	5-147723-7	5-147728-7	5-147729-7
9	.900 [22.86]	.800 [20.32]	5-147738-8	5-147737-8	5-147736-8	5-147723-8	5-147728-8	5-147729-8
10	1.000 [25.40]	.900 [22.86]	5-147738-9	5-147737-9	5-147736-9	5-147723-9	5-147728-9	5-147729-9
11	1.100 [27.94]	1.000 [25.40]	6-147738-0	6-147737-0	6-147736-0	6-147723-0	6-147728-0	6-147729-0
12	1.200 [30.48]	1.100 [27.94]	6-147738-1	6-147737-1	6-147736-1	6-147723-1	6-147728-1	6-147729-1
13	1.300 [33.02]	1.200 [30.48]	6-147738-2	6-147737-2	6-147736-2	6-147723-2	6-147728-2	6-147729-2
14	1.400 [35.56]	1.300 [33.02]	6-147738-3	6-147737-3	6-147736-3	6-147723-3	6-147728-3	6-147729-3
15	1.500 [38.10]	1.400 [35.56]	6-147738-4	6-147737-4	6-147736-4	6-147723-4	6-147728-4	6-147729-4
16	1.600 [40.64]	1.500 [38.10]	6-147738-5	6-147737-5	6-147736-5	6-147723-5	6-147728-5	6-147729-5
17	1.700 [43.18]	1.600 [40.64]	6-147738-6	6-147737-6	6-147736-6	6-147723-6	6-147728-6	6-147729-6
18	1.800 [45.72]	1.700 [43.18]	6-147738-7	6-147737-7	6-147736-7	6-147723-7	6-147728-7	6-147729-7
19	1.900 [48.26]	1.800 [45.72]	6-147738-8	6-147737-8	6-147736-8	6-147723-8	6-147728-8	6-147729-8
20	2.000 [50.80]	1.900 [48.26]	6-147738-9	6-147737-9	6-147736-9	6-147723-9	6-147728-9	6-147729-9
30	3.000 [76.20]	2.900 [73.66]	7-147738-9	7-147737-9	7-147736-9	7-147723-9	7-147728-9	7-147729-9
40	4.000 [101.60]	3.900 [99.06]	8-147738-9	8-147737-9	8-147736-9	8-147723-9	8-147728-9	8-147729-9

**Notes:** 1. Tyco Electronics recommends mating gold or duplex plated headers with duplex plated receptacle assemblies.  
2. To obtain the minimum mating post length, add .020 [0.51] (not including the post lead in chamfer) to the maximum point-of-contact dimension, and .062 [1.57] for recommended board thickness if used in bottom entry application.

**Note:** All part numbers are RoHS compliant.



**Mod IV Surface Mount Receptacle Assemblies, Double-Row, .100 x .100 [2.54 x 2.54] Centers**

**Surface Mount, Double Row, Dual Entry with Holddowns**

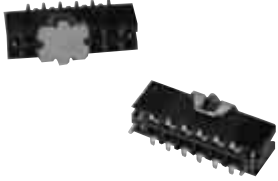

**Material and Finish**

**Housing** — Glass-filled thermoplastic, black, 94V-0 rated

**Contacts** — Phosphor bronze, plated as follows:

**Plating A** — Duplex .000030 [0.00076] gold on contact area, .000150-.000300 [0.00381-0.00762] matte tin on solder area all over .000050 [0.00127] nickel

**Plating B** — Duplex .000010 [0.000254] gold on contact area, .000150-.000300 [0.00381-0.00762] matte tin on solder area all over .000050 [0.00127] nickel

**Plating C** — .000150-.000300 [0.00381-0.00762] matte tin on solder leads, all over .000050 [0.00127] nickel

**Related Product Data**

**Mateable Headers** — Refer to Mating Post Selection Guide — page 90

**Performance Specifications** — page 186

**Technical Documents** — page 276

**Product Specification**  
108-25022

**Application Specification**  
114-25018

**Additional receptacle assembly sizes are available; minimum order quantities may apply. Consult Tyco Electronics.**



**Keying Plug**



**Part No. 86286-1**  
(Plugs into receptacle contact)

**Material** — Natural color nylon

**Note:** All part numbers are RoHS compliant.

## Mod IV Surface Mount Receptacle Assemblies, Double-Row, .100 x .100 [2.54 x 2.54] Centers (Continued)

No. of Pos.	Dimensions				D	Packaged in Tubes			Packaged in Tape and Reel		
	A	B	C	See Note 1		Contact Plating/Part Nos.			Contact Plating/Part Nos.		
						Plating A	Plating B	Plating C	Plating A	Plating B	Plating C
10	.700 [17.78]	.400 [10.16]	.600 [15.24]	See Note 1	5-147102-5	5-147101-5	5-147103-5	5-147747-5	5-147746-5	5-147745-5	
14	.900 [22.86]	.600 [15.24]	.800 [20.32]	See Note 1	5-147102-7	5-147101-7	5-147103-7	5-147747-7	5-147746-7	5-147745-7	
20	1.200 [30.48]	.900 [22.86]	1.100 [27.94]	See Note 1	6-147102-0	6-147101-0	6-147103-0	6-147747-0	6-147746-0	6-147745-0	
22	1.300 [33.02]	1.000 [25.40]	1.200 [30.48]	See Note 1	6-147102-1	6-147101-1	6-147103-1	6-147747-1	6-147746-1	6-147745-1	
26	1.500 [38.10]	1.200 [30.48]	1.400 [35.56]	See Note 1	6-147102-3	6-147101-3	6-147103-3	6-147747-3	6-147746-3	6-147745-3	
30	1.700 [43.18]	1.400 [35.56]	1.600 [40.64]	See Note 1	6-147102-5	6-147101-5	6-147103-5	6-147747-5	6-147746-5	6-147745-5	
34	1.900 [48.26]	1.600 [40.64]	1.800 [45.72]	See Note 1	6-147102-7	6-147101-7	6-147103-7	6-147747-7	6-147746-7	6-147745-7	
36	2.000 [50.08]	1.700 [43.18]	1.900 [48.26]	See Note 1	6-147102-8	6-147101-8	6-147103-8	6-147747-8	6-147746-8	6-147745-8	
40	2.200 [55.88]	1.900 [48.26]	2.100 [53.34]	See Note 1	7-147102-0	7-147101-0	7-147103-0	7-147747-0	7-147746-0	7-147745-0	
46	2.500 [63.50]	2.200 [55.88]	2.400 [60.96]	See Note 1	7-147102-3	7-147101-3	7-147103-3	7-147747-3	7-147746-3	7-147745-3	
50	2.700 [68.58]	2.400 [60.96]	2.600 [66.04]	See Note 1	7-147102-5	7-147101-5	7-147103-5	7-147747-5	7-147746-5	7-147745-5	
62	3.300 [83.82]	3.000 [76.20]	3.200 [81.28]	See Note 1	8-147102-1	8-147101-1	8-147103-1	8-147747-1	8-147746-1	8-147745-1	
64	3.400 [86.36]	3.100 [78.74]	3.300 [83.82]	See Note 1	8-147102-2	8-147101-2	8-147103-2	8-147747-2	8-147746-2	8-147745-2	
66	3.500 [88.90]	3.200 [81.28]	3.400 [86.36]	See Note 1	8-147102-3	8-147101-3	8-147103-3	8-147747-3	8-147746-3	8-147745-3	
70	3.700 [95.98]	3.400 [86.36]	3.600 [91.44]	See Note 1	8-147102-5	8-147101-5	8-147103-5	8-147747-5	8-147746-5	8-147745-5	
80	4.300 [109.22]	3.900 [99.06]	4.200 [106.68]	2.100 [53.34]	9-147102-0	9-147101-0	9-147103-0	9-147747-0	9-147746-0	9-147745-0	

**Notes:** 1. No center holddown.

2. To obtain the minimum mating post length, add .020 [0.51] (not including the post lead in chamfer) to the maximum point-of-contact dimension and .062 [1.57] for recommended board thickness in bottom entry applications.

**Note:** All part numbers are RoHS compliant.

**Mod IV Surface Mount Receptacle Assemblies, Double-Row,  
.100 x .100 [2.54 x 2.54] Centerline**

**Surface Mount, Double Row,  
Dual Entry  
End to End Stackable**



**Material and Finish**

**Housing** — Glass-filled thermoplastic, black, 94V-0 rated

**Contacts** — Phosphor bronze, plated as follows:

**Plating A** — Duplex .000030 [0.00076] gold on contact area, .000150-.000300 [0.00381-0.00762] matte tin on solder area all over .000050 [0.00127] nickel

**Plating B** — Duplex .000010 [0.000254] gold on contact area, .000150-.000300 [0.00381-0.00762] matte tin on solder area all over .000050 [0.00127] nickel

**Plating C** — .000150-.000300 [0.00381-0.00762] tin-lead over .000050 [0.00127] nickel



**Related Product Data**

**Mateable Headers** — Refer to Mating Post Selection Guide — page 90

**Performance Specifications** — page 186



**Recommended PC Board Pad Layout  
(.008 [0.20] thick stencil)  
(for Bottom Entry and Pass Through applications)**

**Technical Documents** — page 276

**Product Specification**  
108-25022

**Application Specification**  
114-25018

**Additional receptacle assembly sizes are available; minimum order quantities may apply. Consult Tyco Electronics.**

**Keying Plug**



**Part No. 86286-1**  
(Plugs into receptacle contact)

**Material** — Natural color nylon

**Note:** All part numbers are RoHS compliant.

## Mod IV Surface Mount Receptacle Assemblies, Double-Row, .100 x .100 [2.54 x 2.54] Centerline (Continued)

No. of Pos.	Dimensions		Packaged in Tubes			Packaged in Tape & Reel		
			Contact Plating/ Part Nos.			Contact Plating/ Part Nos.		
	A	B	Plating A	Plating B	Plating C	Plating A	Plating B	Plating C
10	.500 [12.70]	.400 [10.16]	5-147741-5	5-147740-5	5-147739-5	5-147105-5	5-147104-5	5-147106-5
14	.700 [17.78]	.600 [15.24]	5-147741-7	5-147740-7	5-147739-7	5-147105-7	5-147104-7	5-147106-7
20	1.000 [25.40]	.900 [22.86]	6-147741-0	6-147740-0	6-147739-0	6-147105-0	6-147104-0	6-147106-0
22	1.100 [27.94]	1.000 [25.40]	6-147741-1	6-147740-1	6-147739-1	6-147105-1	6-147104-1	6-147106-1
26	1.300 [33.02]	1.200 [30.48]	6-147741-3	6-147740-3	6-147739-3	6-147105-3	6-147104-3	6-147106-3
30	1.500 [38.10]	1.400 [35.56]	6-147741-5	6-147740-5	6-147739-5	6-147105-5	6-147104-5	6-147106-5
34	1.700 [43.18]	1.600 [40.64]	6-147741-7	6-147740-7	6-147739-7	6-147105-7	6-147104-7	6-147106-7
36	1.800 [45.72]	1.700 [43.18]	6-147741-8	6-147740-8	6-147739-8	6-147105-8	6-147104-8	6-147106-8
40	2.000 [50.80]	1.900 [48.26]	7-147741-0	7-147740-0	7-147739-0	7-147105-0	7-147104-0	7-147106-0
46	2.300 [58.42]	2.200 [55.88]	7-147741-3	7-147740-3	7-147739-3	7-147105-3	7-147104-3	7-147106-3
50	2.500 [63.50]	2.400 [60.96]	7-147741-5	7-147740-5	7-147739-5	7-147105-5	7-147104-5	7-147106-5
62	3.100 [78.74]	3.000 [76.20]	8-147741-1	8-147740-1	8-147739-1	8-147105-1	8-147104-1	8-147106-1
64	3.200 [81.28]	3.100 [78.74]	8-147741-2	8-147740-2	8-147739-2	8-147105-2	8-147104-2	8-147106-2
66	3.300 [83.82]	3.200 [81.28]	8-147741-3	8-147740-3	8-147739-3	8-147105-3	8-147104-3	8-147106-3
70	3.500 [88.90]	3.400 [86.36]	8-147741-5	8-147740-5	8-147739-5	8-147105-5	8-147104-5	8-147106-5
80	4.000 [101.60]	3.900 [99.06]	9-147741-0	9-147740-0	9-147739-0	9-147105-0	9-147104-0	9-147106-0

**Notes:** 1. To obtain the minimum mating post length, add .020 [0.51] (not including the post lead in chamfer) to the maximum point-of-contact dimension and .062 [1.57] for recommended board thickness in bottom entry applications.

**Note:** All part numbers are RoHS compliant.

## Two-Piece Printed Circuit Board Connectors

### Product Facts

- Two-Piece reliability
- Two- and three-row systems available
- Short signal path for VLSI applications
- Receptacles employ dual cantilever beams and built-in anti-overstress to provide reliable connections
- Built-in guides provide alignment before contact engagement
- Closed entry receptacle housings provide lead-in ramp for positive mating of contacts
- Shrouded headers provide full pin protection
- Polarized headers
- Vertical headers available with ACTION PIN posts or .025 [0.64] square solder posts
- Repairable ACTION PIN posts
- Simple seating tooling for headers with ACTION PIN posts
- Recognized under the Component Program of Underwriters Laboratories Inc., File No. E28476
- Certified by Canadian Standards Association, File No. LR 7189

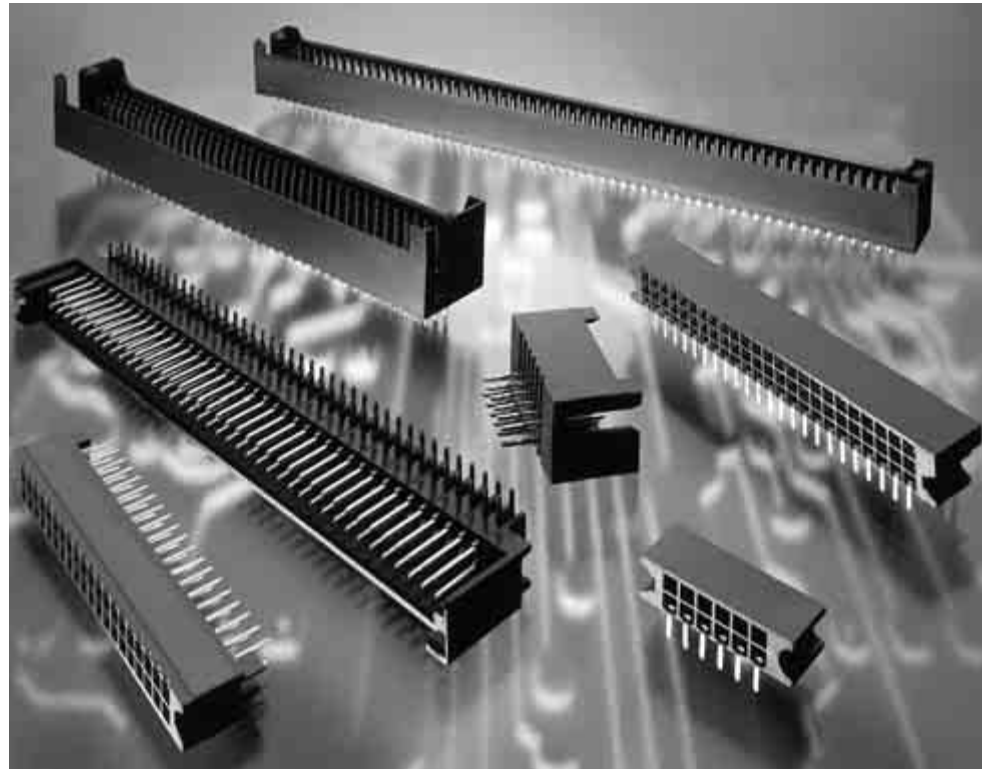

ACTION PIN Posts



Solder Posts



Receptacle Contact  
(Double Beam with Anti-Overstress)  
Board Retention Feature Available



**Note:** All part numbers are RoHS compliant.

For drawings, technical data or samples, contact your Tyco Electronics sales engineer or call the Tyco Electronics Product Information Center: 1-800-522-6752

**Two-Piece Printed Circuit Board Connectors** (Continued)

AMPMODU Two-Piece Printed Circuit Board connectors are designed to reliably and economically meet the packaging and interconnection requirements of today's sophisticated electronics.

The double row system is produced in 10 thru 200 positions in the vertical headers and horizontal receptacles, and 10 thru 160 positions in the right angle headers and vertical receptacles.

The AMPMODU three-row connector system is produced in 30 through 300 positions (straight post headers and mating horizontal receptacles).

Both two- and three-row vertical headers are available with press-fit ACTION PIN posts or standard .025 [0.64] square solder posts. There is a simple seating tool for headers with ACTION PIN posts.

A board retention feature is offered in the two-row horizontal receptacles, two-row right angle headers and two- and three-row vertical headers. Built-in guides assure accurate header and receptacle alignment before contact engagement.

Closed entry receptacle housings provide a lead-in ramp for positive mating of contacts.

**Performance Specifications**

- Current Rating** — 3 amperes max. for single contact; 2 amperes max. per contact for fully energized connector
- Voltage Rating** — 250 VAC
- Dielectric Rating** — 750 VAC rms between contacts for one minute
- Termination Resistance** — 12 milliohms max. at 100 milliamperes test current, and 50 millivolts open circuit voltage
- Insulation Resistance** — 1000 megohms after temperature/humidity cycling

- Temperature Rating** — Headers and Receptacles — -65°C to +125°C (black thermoplastic housings, 94V-0 rated)
- Durability (Tested to)** — 200 cycles for .000030 [0.00076] gold plating; 75 cycles for .000015 [0.00038] gold plating
- Mating Force** — 8 oz. [2.22N] maximum per contact
- Unmating Force** — .75 oz. [0.2N] minimum per contact during third mating cycle



## Receptacle Assemblies, Board Mount, Double-Row, Closed Entry, .100 x .100 [2.54 x 2.54] Centerline

### Horizontal Mount (with Guide Pin Slots and Standoffs)



#### Material and Finish

**Housing** — Glass-filled thermoplastic, black, 94V-0 rated

**Contacts** — Phosphor bronze, plated as follows:

**Plating A** — Duplex plated .000030 [0.00076] gold on contact area, .000050-.000100 [0.00127-0.00254] matte tin on solder area, with entire contact underplated .000050 [0.00127] nickel

**Plating B** — Duplex plated .000015 [0.00038] gold on contact area, .000050-.000100 [0.00127-0.00254] matte tin on solder area, with entire contact underplated .000050 [0.00127] nickel

#### Related Product Data

**Mateable Headers** — pages 198, 199

**Performance Specifications** — page 194

**Technical Documents** — page 276

#### Product Specification

108-25017

#### Application Specification

114-9009

**Additional receptacle assembly sizes and solder tail lengths are available; minimum order quantities may apply. Consult Tyco Electronics.**

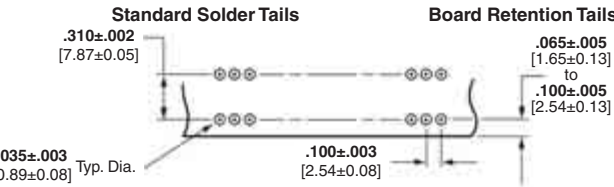
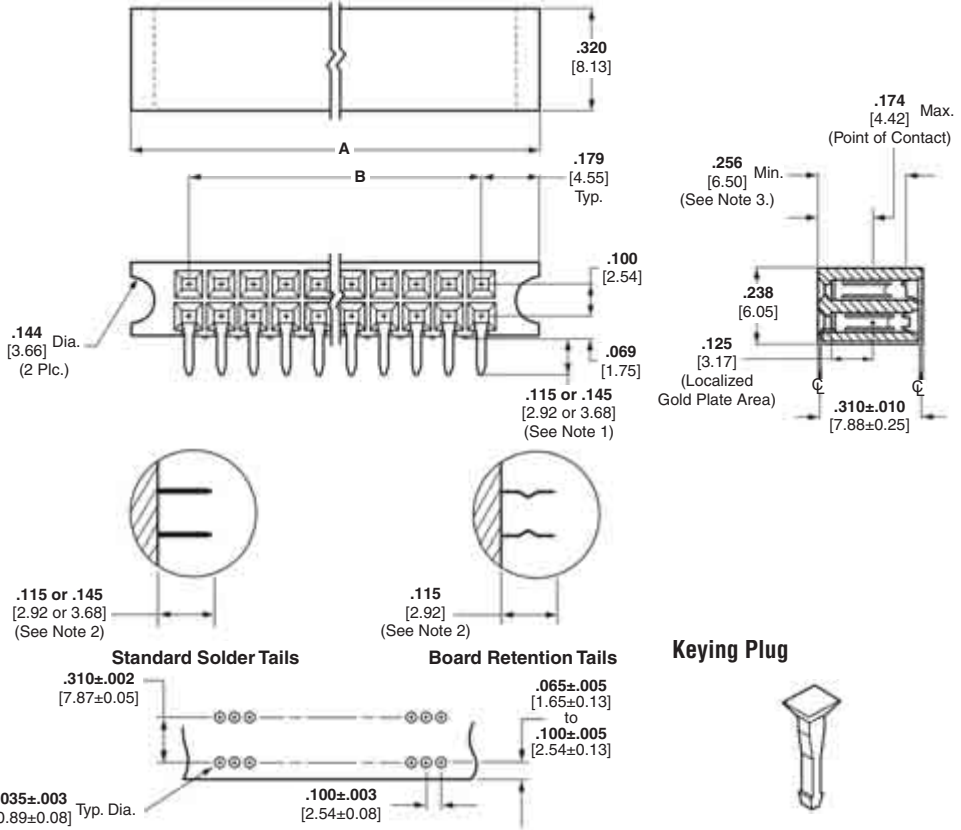

**Recommended PC Board Hole Layout (for .055 [1.40] min. thick PC board)**

Tolerances not to accumulate within one connector pattern.

#### Keying Plug



**Part No. 86286-1**

(Plugs into receptacle contact)

**Material** — Natural color nylon

No. of Pos.	Dimensions		Receptacle Assembly Part Nos. with .115 [2.92] Solder Tail Lengths				Receptacle Assembly Part Nos. with .145 [3.68] Solder Tail Lengths
	A	B	Standard Solder Tails		Board Retention Tails		Standard Solder Tails
			Plating A	Plating B	Plating A	Plating B	
12	.858 [21.79]	.500 [12.70]	5-532956-1	5-532955-1	5-534204-2	5-534975-5	5-533009-1
14	.958 [24.33]	.600 [15.24]	—	7-532955-5	—	—	—
16	1.058 [26.87]	.700 [17.78]	5-532956-2	—	6-534204-0	6-534975-5	—
20	1.258 [31.95]	.900 [22.86]	5-532956-3	5-532955-3	5-534204-9	5-534975-6	—
24	1.458 [37.03]	1.100 [27.94]	5-532956-4	5-532955-4	6-534204-1	5-534975-7	—
30	1.758 [44.65]	1.400 [35.56]	5-532956-5	5-532955-5	5-534204-4	5-534975-8	5-533009-5
36	2.058 [52.27]	1.700 [43.18]	5-532956-6	5-532955-6	5-534204-3	5-534975-9	—
40	2.258 [57.35]	1.900 [48.26]	5-532956-7	5-532955-7	6-534204-2	6-534975-0	—
50	2.758 [70.05]	2.400 [60.96]	5-532956-8	5-532955-8	5-534204-1	6-534975-1	5-533009-8
60	3.258 [82.75]	2.900 [73.66]	5-532956-9	5-532955-9	5-534204-5	6-534975-2	5-533009-9
70	3.758 [95.45]	3.400 [86.36]	6-532956-0	6-532955-0	6-534204-3	6-534975-3	6-533009-0
72	3.858 [97.99]	3.500 [88.90]	6-532956-1	6-532955-1	6-534204-4	—	—
80	4.258 [108.15]	3.900 [99.06]	6-532956-2	6-532955-2	5-534204-8	6-534975-4	6-533009-2
86	4.558 [115.77]	4.200 [106.68]	6-532956-3	6-532955-3	—	—	6-533009-3
90	4.758 [120.85]	4.400 [111.76]	6-532956-4	6-532955-4	—	—	—
96	5.058 [128.47]	4.700 [119.38]	6-532956-5	6-532955-5	6-534204-5	—	6-533009-5
100	5.258 [133.55]	4.900 [124.46]	6-532956-6	6-532955-6	5-534204-6	5-534975-1	6-533009-6
110	5.758 [146.25]	5.400 [137.16]	6-532956-7	6-532955-7	6-534204-6	—	—
120	6.258 [158.95]	5.900 [149.86]	6-532956-8	6-532955-8	5-534204-7	5-534975-2	6-533009-8
130	6.758 [171.65]	6.400 [162.56]	7-532956-0	7-532955-0	6-534204-7	—	—
200	10.258 [260.55]	9.900 [251.46]	7-532956-3	7-532955-3	7-534204-0	5-534975-4	—

**Notes:** 1. .115 [2.92] tail length is for use with .062 [1.57] PC boards; .145 [3.68] tail length is for use with .093 [2.36] PC boards.

2. Receptacle assemblies with low force contacts are available, consult Tyco Electronics.

3. .256 [6.50] minimum positive pin stop to prevent shorting between rows.

**Note:** All part numbers are RoHS compliant.

**Receptacle Assemblies, Board Mount, Double-Row, Closed Entry, .100 x .100 [2.54 x 2.54] Centerline** (Continued)

**Vertical Mount (with Guide Pin Slots and Standoffs)**

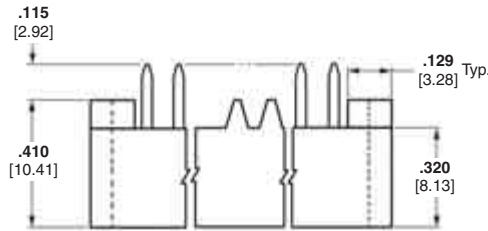

**Material and Finish**

**Housing** — Glass-filled thermoplastic, black, 94V-0 rated

**Contacts** — Phosphor bronze, duplex plated .000030 [0.00076] gold on contact area, .000050-.000100 [0.00127-0.00254] matte tin on solder area, with entire contact underplated .000050 [0.00127] nickel

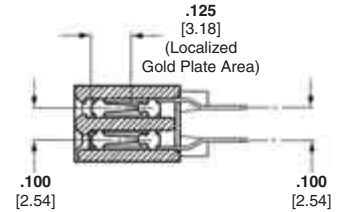
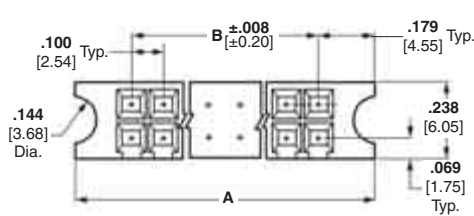

**Related Product Data**

**Mateable Headers** — pages 198, 199

**Performance Specifications** — page 194

**Technical Documents** — page 276

**Product Specification**  
108-25017

**Application Specification**  
114-9009

**Additional receptacle assembly sizes and solder tail lengths are available; minimum order quantities may apply. Consult Tyco Electronics.**

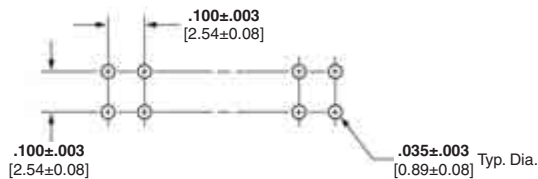

**Recommended PC Board Hole Layout (for .055 [1.40] min. thick PC board)**

Tolerances not to accumulate within one connector pattern.

**Keying Plug**



**Part No. 86286-1**  
(Plugs into receptacle contact)

**Material** — Natural color nylon

No. of Pos.	Dimensions		Receptacle Assembly Part Nos.
	A	B	
30	1.758 [44.65]	1.400 [35.56]	5-534972-1
40	2.258 [57.35]	1.900 [48.26]	5-534972-2
50	2.758 [70.05]	2.400 [60.96]	5-534972-3
60	3.258 [82.75]	2.900 [73.66]	5-534972-4
70	3.758 [95.45]	3.400 [86.36]	5-534972-5
80	4.258 [108.15]	3.900 [99.06]	5-534972-6
90	4.758 [120.85]	4.400 [111.76]	5-534972-7
100	5.258 [133.55]	4.900 [124.46]	5-534972-8
120	6.258 [158.95]	5.900 [149.86]	6-534972-0

**Note:** All part numbers are RoHS compliant.

**Receptacle Assemblies, Board Mount, Triple-Row, Closed Entry, .100 x .100 [2.54 x 2.54] Centerline**

**Horizontal Mount (with Guide Pin Slots and Standoffs)**

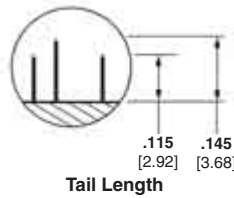
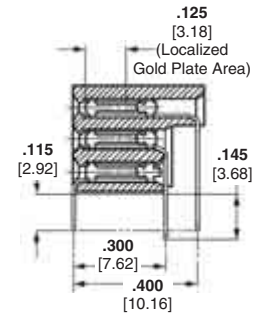
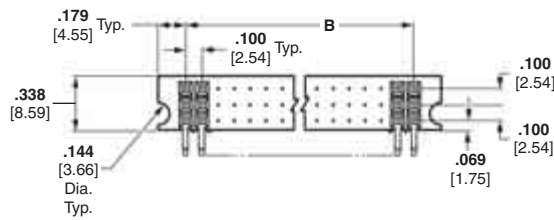
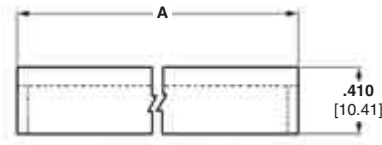
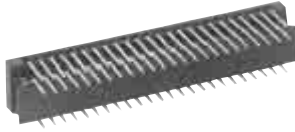

**Material and Finish**

**Housing** — Glass-filled thermoplastic, black, 94V-0 rated

**Contacts** — Phosphor bronze, plated .000030 [0.00076] gold in mating area, .000050-.000100 [0.00127-0.00254] matte tin on solder area, with entire contact underplated .000050 [0.00127] nickel

**Related Product Data**

**Mateable Headers** — page 201

**Performance Specifications** — page 194

**Technical Documents** — page 276

**Product Specification**  
108-25017

**Application Specification**  
114-9009

**Additional receptacle assembly sizes and solder tail lengths are available; minimum order quantities may apply. Consult Tyco Electronics.**

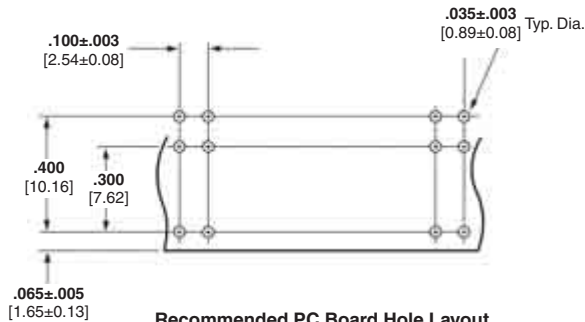

**Recommended PC Board Hole Layout (for .055 [1.40] min. thick PC board)**

Tolerances not to accumulate within one connector pattern.

No. of Pos.	Dimensions		Receptacle Assembly Part Nos. Plating A
	A	B	
72	2.658 [67.51]	2.300 [58.42]	5-534974-3
93	3.358 [85.29]	3.000 [76.20]	5-534974-4
96	3.458 [87.83]	3.100 [78.74]	5-534974-5
150	5.258 [133.55]	4.900 [124.46]	5-534974-8
210	7.258 [184.35]	6.900 [175.26]	6-534974-1

**Keying Plug**



**Part No. 86286-1**  
(Plugs into receptacle contact)

**Material** — Natural color nylon

**Note:** All part numbers are RoHS compliant.

**Headers, Straight Post, Double-Row, .100 x .100 [2.54 x 2.54] Centerline**

**Solder Posts and ACTION PIN Posts (with Pin Protection and Guide Pins)**



**Material and Finish**

**Housing** — Glass-filled thermoplastic, black, 94V-0 rated

**Posts** — Phosphor bronze, plated as follows:

**Plating A** — Duplex plated .000030 [0.00076] gold on contact area, .000100-.000200 [0.00254-0.00508] matte tin on termination end, with entire post underplated .000050 [0.00127] nickel

**Plating B** — Duplex plated .000015 [0.00038] gold on contact area, .000100-.000200 [0.00254-0.00508] matte tin on termination end, with entire post underplated .000050 [0.00127] nickel

**Plating C** — Selectively plated .000030 [0.00076] gold on contact area and .000015 [0.00038] gold on termination end, with gold flash over .000050 [0.00127] nickel on entire post



**Recommended PC Board Hole Layout (for .055 [1.40] min. thick PC board)**

Tolerances not to accumulate within one connector pattern.

**Related Product Data**

**Mateable Receptacles** — pages 195, 196

**Performance Specifications** — page 194

**ACTION PIN Posts** — pages 150, 151

**Application Tooling** — pages 152

**Technical Documents** — page 276

**Product Specification** 108-25017

**Application Specification** 114-9009

**Additional header sizes are available; minimum order quantities may apply. Consult Tyco Electronics.**

No. of Pos.	Dimensions		Header Part Nos. with .180 [4.57] Tail Length			
	A	B	Standard Solder Tails		Board Retention Tails	
			Plating A	Plating B	Plating A	Plating B
12	.980 [24.89]	.500 [12.70]	5-102692-1	5-102567-1	6-534978-6	5-534257-5
14	1.080 [27.43]	.600 [15.24]	—	7-102567-3	—	—
16	1.180 [29.97]	.700 [17.78]	6-102692-5	—	5-534978-2	6-534257-4
20	1.380 [35.05]	.900 [22.86]	6-102692-6	6-102567-1	5-534978-3	5-534257-6
24	1.580 [40.13]	1.100 [27.94]	5-102692-2	5-102567-2	5-534978-4	5-534257-7
30	1.880 [47.75]	1.400 [35.56]	6-102692-7	6-102567-3	5-534978-5	5-534257-8
36	2.180 [55.37]	1.700 [43.18]	5-102692-3	5-102567-3	5-534978-6	5-534257-9
40	2.380 [60.45]	1.900 [48.26]	6-102692-3	6-102567-2	5-534978-7	6-534257-0
50	2.880 [73.15]	2.400 [60.96]	5-102692-4	5-102567-6	5-534978-8	6-534257-5
60	3.380 [85.85]	2.900 [73.66]	5-102692-5	5-102567-4	5-534978-9	6-534257-1
70	3.880 [98.55]	3.400 [86.36]	6-102692-4	6-102567-0	6-534978-5	6-534257-2
72	3.980 [101.09]	3.500 [88.90]	6-102692-8	6-102567-6	6-534978-0	—
80	4.380 [111.25]	3.900 [99.06]	5-102692-6	5-102567-8	6-534978-1	5-534257-1
86	4.680 [118.87]	4.200 [106.68]	6-102692-9	6-102567-7	—	—
90	4.880 [123.95]	4.400 [111.76]	6-102692-2	6-102567-4	—	—
96	5.180 [131.57]	4.700 [119.38]	5-102692-7	5-102567-5	6-534978-7	—
100	5.380 [136.65]	4.900 [124.46]	5-102692-8	5-102567-9	6-534978-8	5-534257-2
110	5.880 [149.35]	5.400 [137.16]	6-102692-0	6-102567-5	6-534978-2	—
120	6.380 [162.05]	5.900 [149.86]	5-102692-9	5-102567-7	6-534978-3	5-534257-3
130	6.880 [174.75]	6.400 [162.56]	7-102692-0	6-102567-9	6-534978-9	—
200	10.380 [263.65]	9.900 [251.46]	6-102692-1	7-102567-1	5-534978-1	6-534257-9

**Note:** Headers with make first/break last posts can be made available, consult Tyco Electronics.

**Note:** All part numbers are RoHS compliant.

## Headers, Straight Post, Double-Row, .100 x .100 [2.54 x 2.54] Centerline (Continued)



No. of Pos.	Dimensions		Header Part Nos. with ACTION PIN Posts					
	A	B	.250 [6.35] Tail Length		.480 [12.19] Tail Length		.680 [17.27] Tail Length	
			Plating A	Plating B	Plating A	Plating C	Plating C	
12	.980 [24.89]	.500 [12.70]	5-102690-1	5-103291-4	—	—	—	
14	1.080 [27.43]	.600 [15.24]	—	5-103291-3	—	—	—	
20	1.380 [35.05]	.900 [22.86]	6-102690-3	5-103291-6	—	—	—	
24	1.580 [40.13]	1.100 [27.94]	5-102690-2	5-103291-7	—	—	—	
36	2.180 [55.37]	1.700 [43.18]	5-102690-3	5-103291-9	—	—	—	
40	2.380 [60.45]	1.900 [48.26]	6-102690-6	5-103291-2	—	—	—	
50	2.880 [73.15]	2.400 [60.96]	5-102690-4	6-103291-0	—	—	—	
60	3.380 [85.85]	2.900 [73.66]	5-102690-5	6-103291-1	—	—	—	
70	3.880 [98.55]	3.400 [86.36]	6-102690-7	6-103291-2	—	—	—	
80	4.380 [111.25]	3.900 [99.06]	5-102690-6	6-103291-4	—	—	—	
90	4.880 [123.95]	4.400 [111.76]	6-102690-1	6-103291-6	—	—	—	
96	5.180 [131.57]	4.700 [119.38]	5-102690-7	6-103291-8	—	—	—	
100	5.380 [136.65]	4.900 [124.46]	5-102690-8	6-103291-9	—	—	102777-3	
120	6.380 [162.05]	5.900 [149.86]	5-102690-9	7-103291-1	5-102691-9	1-102666-1	102777-1	
130	6.880 [174.75]	6.400 [162.56]	—	—	—	102666-9	—	

**Notes:** 1. Other header sizes can be made available upon request.

Headers with ACTION PIN posts are for use with .093 [2.36] nominal or thicker PC boards.

2. Application tooling for installing headers with ACTION PIN posts is shown on pages 152 and 153.

3. Headers with .250 [6.35] tail length can be made available with make first/break last contacts, consult Tyco Electronics.

4. Plated through holes to be prepared per recommendations found on page 151.

**Note:** All part numbers are RoHS compliant.

## Headers, Right-Angle Post, Double-Row, .100 x .100 [2.54 x 2.54] Centerline

### Card Extender (with Pin Protection and Guide Pins)



### Material and Finish

**Housing** — Glass-filled thermoplastic, black, 94V-0 rated

**Posts** — Phosphor bronze, plated as follows:

**Plating A** — Duplex plated .000030 [0.00076] gold on contact area, .000100-.000200 [0.00254-0.00508] matte tin on termination end, with entire post underplated .000050 [0.00127] nickel

**Plating B** — Duplex plated .000015 [0.00038] gold on contact area, .000100-.000200 [0.00254-0.00508] matte tin on termination end, with entire post underplated .000050 [0.00127] nickel

### Related Product Data

**Mateable Receptacles** — pages 195, 196

**Performance Specifications** — page 194

**Technical Documents** — page 276

**Product Specification**  
108-25017

**Application Specification**  
114-9009

**Additional header sizes are available; minimum order quantities may apply. Consult Tyco Electronics.**

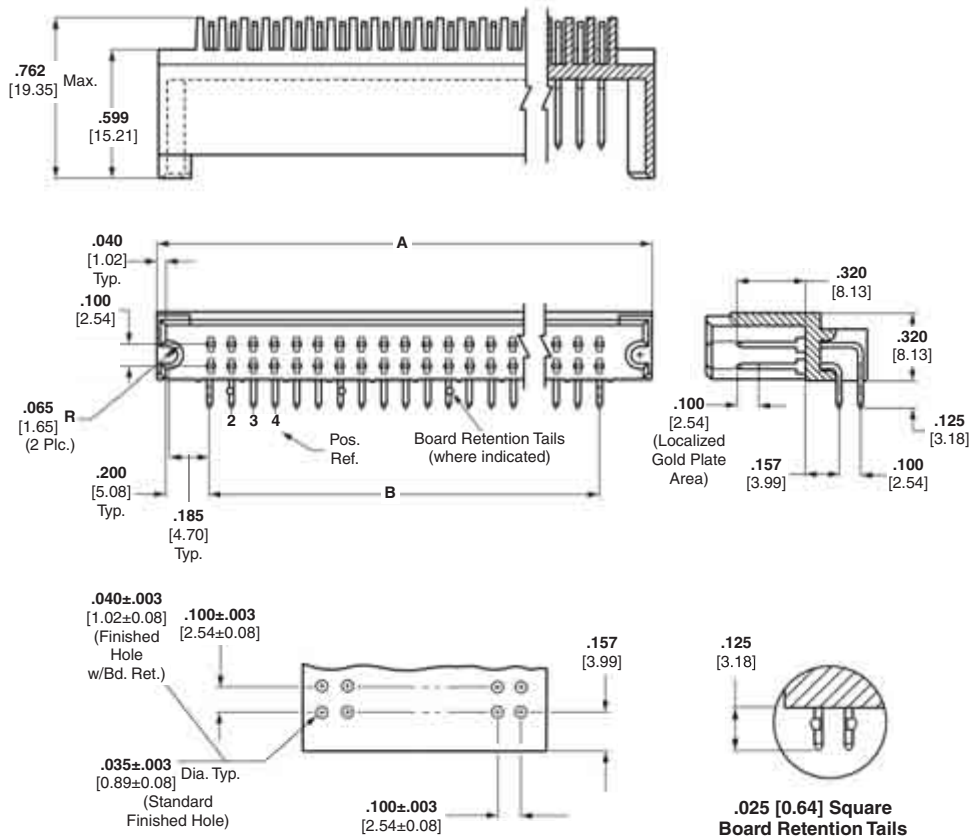

**Recommended PC Board Hole Layout (for .055 [1.40] min. thick PC board)**

Tolerances not to accumulate within one connector pattern.

No. of Pos.	Dimensions		Header Part Nos. with .125 [3.18] Tail Length		
	A	B	Standard Solder Tails		Board Retention Tails
			Plating A	Plating B	Plating A
12	.980 [24.89]	.500 [12.70]	6-102802-2	5-102589-8	5-534245-5
16	1.180 [29.97]	.700 [17.78]	6-102802-4	—	5-534245-4
20	1.380 [35.05]	.900 [22.86]	6-102802-5	6-102589-2	5-534245-6
24	1.580 [40.13]	1.100 [27.94]	6-102802-3	5-102589-6	5-534245-7
30	1.880 [47.75]	1.400 [35.56]	6-102802-6	5-102589-4	5-534245-2
36	2.180 [55.37]	1.700 [43.18]	5-102802-3	5-102589-2	5-534245-8
40	2.380 [60.45]	1.900 [48.26]	5-102802-8	6-102589-3	—
50	2.880 [73.15]	2.400 [60.96]	5-102802-4	5-102589-5	5-534245-1
60	3.380 [85.85]	2.900 [73.66]	5-102802-9	5-102589-7	—
72	3.980 [101.09]	3.500 [88.90]	6-102802-7	6-102589-7	—
80	4.380 [111.25]	3.900 [99.06]	5-102802-5	5-102589-1	6-534245-0
90	4.880 [123.95]	4.400 [111.76]	6-102802-0	6-102589-4	—
100	5.380 [136.65]	4.900 [124.46]	5-102802-6	5-102589-3	6-534245-1
120	6.380 [162.05]	5.900 [149.86]	5-102802-2	6-102589-1	5-534245-3
130	6.880 [174.75]	6.400 [162.56]	6-102802-9	6-102589-9	6-534245-3

**Note:** Headers with make first/break last posts can be made available, consult Tyco Electronics.

**Note:** All part numbers are RoHS compliant.



**Headers, Straight Post, Triple-Row, .100 x .100 [2.54 x 2.54] Centerline**

**Solder Posts (with Pin Protection and Guide Pins)**



**Material and Finish**

**Housing** — Glass-filled thermoplastic, black, 94V-0 rated

**Posts** — Phosphor bronze, plated as follows:

**Plating A** — Duplex plated .000030 [0.00076] gold on contact area, .000100-.000200 [0.00254-0.00508] matte tin on termination end, with entire post underplated .000050 [0.00127] nickel

**Related Product Data**

**Mateable Receptacles** — page 197

**Performance Specifications** — page 194

**Technical Documents** — page 276

**Product Specification**  
108-25017

**Application Specification**  
114-9009

**Additional header assembly sizes are available; minimum order quantities may apply. Consult Tyco Electronics.**

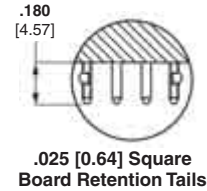
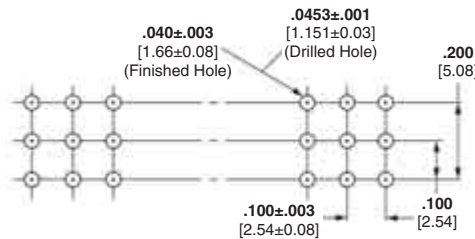
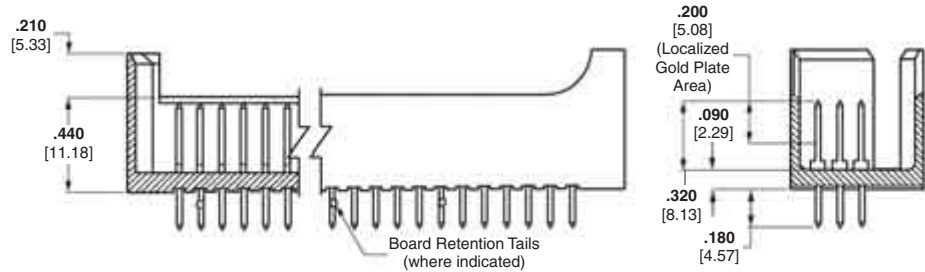

**Recommended PC Board Hole Layout (for .055 [1.40] min. thick PC board)**

Tolerances not to accumulate within one connector pattern.

No. of Pos.	Dimensions		Header Part Nos. with .180 [4.57] Tail Length	
	A	B	Standard Solder Tails Plating A	Board Retention Tails Plating A
72	2.780 [70.61]	2.300 [58.42]	5-103264-1	5-534258-1
96	3.480 [88.39]	3.000 [76.20]	—	5-534258-3
150	5.380 [136.65]	4.900 [124.46]	5-103264-3	—
210	7.380 [187.45]	6.900 [175.26]	5-103264-4	—

**Note:** All part numbers are RoHS compliant.

**Headers, VRM (Voltage Regulator Module),  
.100 x .100 [2.54 x 2.54] Centerline**

**Solder Posts and  
ACTION PIN Posts (with  
Pin Protection, Guide  
Ribs, and Latching)**

**Material and Finish**

**Housing** — Glass-filled thermoplastic, black, 94V-0 rated

**Posts** — Copper alloy, duplex plated .000030 [0.00076] gold on contact area, .000100-.000200 [0.00254-0.00508] matte tin on termination end, with entire post underplated .000050 [0.00127] nickel

**Related Product Data**

**Mateable Receptacles** — pages 195, 196

**Performance Specifications** — page 194

**ACTION PIN Posts** — page 150, 151

**Application Tooling** — pages 152

**Technical Documents** — page 276

**Product Specification**  
108-25017

**Application Specification**  
114-9009

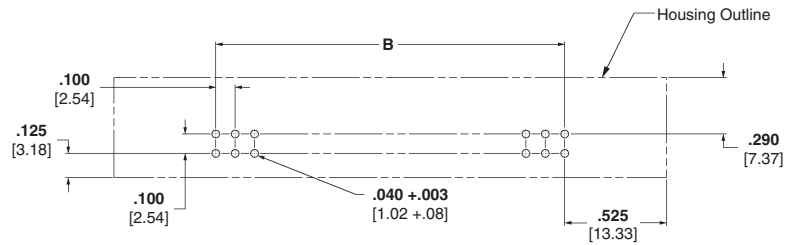
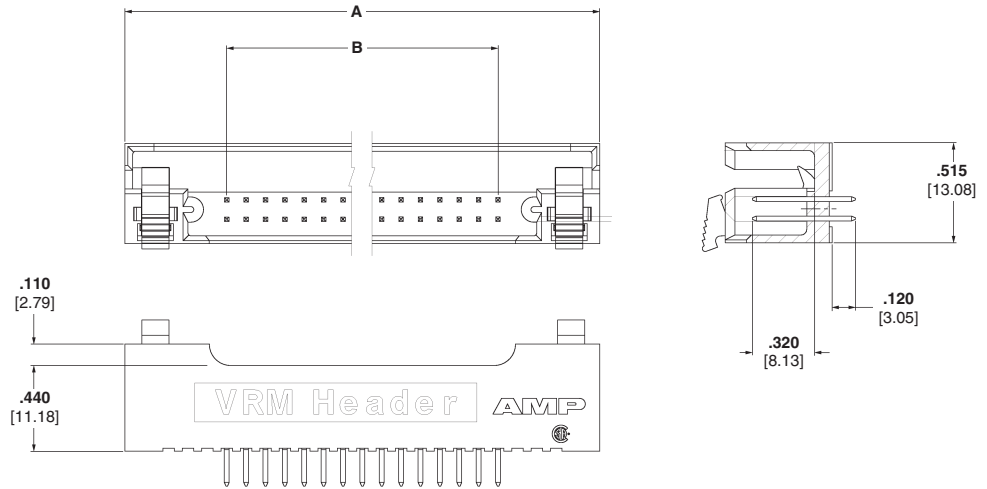

**Recommended PC Board Hole Layout**

No of Pos	Dimensions		Header Part No.	
	A	B	Standard Solder Tails	.250 Length ACTION PIN Tails
30	2.450 [62.23]	1.400 [35.56]	5-146205-1	—
40	3.095 [78.62]	1.900 [48.26]	—	5-147254-1
	3.100 [78.74]	1.900 [48.26]	5-146315-1	—

**Note:** All part numbers are RoHS compliant.

**Accessories: End Shrouds for Machine-Applied Posts**

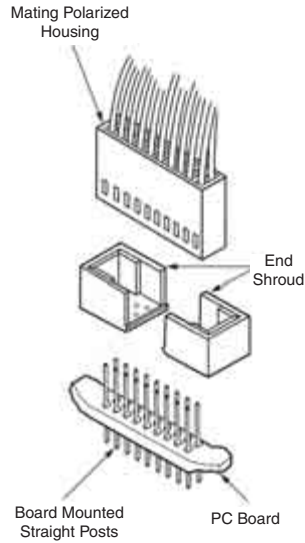

Typical Assembly

Technical Documents — page 276

**Single-Row, .100 [2.54] Centers**  
**Part No. 102338-1**

**Material** — Black thermoplastic, flame retardant

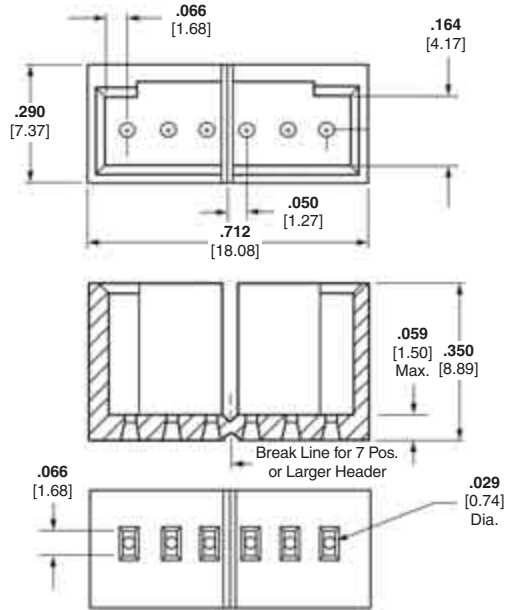

**Double-Row, .100 x .100 [2.54 x 2.54] Centers**  
**Part No. 102114-1**

**Material** — Black glass-filled polyester

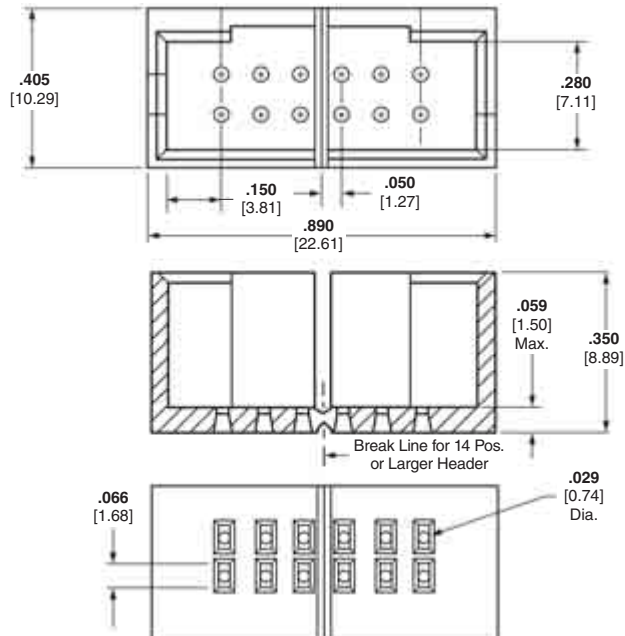

**Note:** All part numbers are RoHS compliant.

**Accessories: Barrier Insert, Part No. 87743-1**

**Material**

Black polyester

**Technical Documents** — page 276

The barrier insert can be used on double row headers (.100 x .100 [2.54 x 2.54] centers), including shrouded versions—3 and 4 sides, as well as unshrouded straight post headers. With one barrier insert several configurations can be obtained, providing headers with capabilities of accepting various combinations of polarized and non-polarized AMPMODU connectors.

For unshrouded headers, the barrier insert is used to establish polarization and to compartmentalize the header. For shrouded headers, the barrier insert is used to compartmentalize the header, while maintaining polarization. The barrier insert itself is notched to facilitate cutting off the ends with a simple tool such as tin snips or scissors to achieve the desired configuration.



**Barrier Insert Cutoffs**

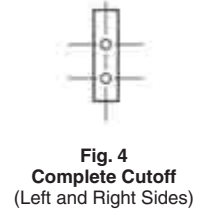
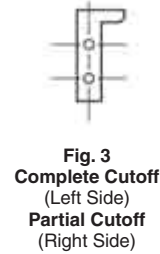
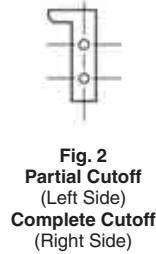
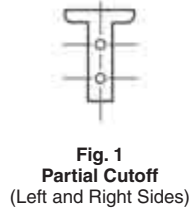

**Typical Barrier Insert Applications**

**For Unshrouded Double-Row, Straight Post Headers, .100 x .100 [2.54 x 2.54] Centers**

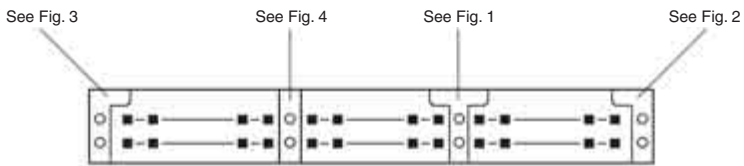

**Note:** All configurations of barrier inserts compartmentalize headers and maintain polarization, except bar (Fig. 4) configuration, which is used primarily for compartmentalizing headers.

**For Shrouded Double-Row, 3 and 4 Sided Headers, .100 x .100 [2.54 x 2.54] Centers**

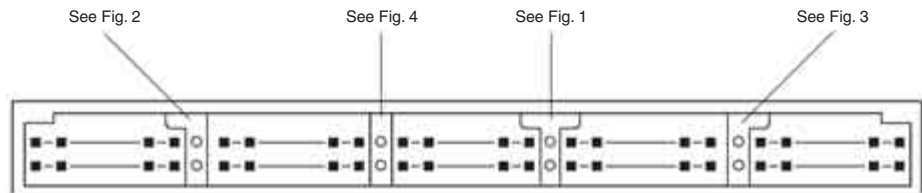

**Note:** Right-angle (Figs. 2 and 3) and "T" (Fig. 1) configurations of barrier insert establish polarization; bar (Fig. 4) configuration of barrier insert compartmentalizes header.

**Note:** All part numbers are RoHS compliant.

**Accessories: Snap-In Polarizer for Low Profile Headers**

**Material**

Black thermoplastic, flame retardant

**Part Numbers**

499991-2 (Packaged 50 per bag)

499991-3 (Packaged 1000 per bag)

**Related Product Data**

Low Profile Headers used with —  
pages 135-140



The snap-in polarizer provides military polarization for low profile headers. Installation of the polarizer is as follows:

Orient the polarizer so that the polarizer latch is on the same side as the inner wall (post side) of the header housing.



Slide the polarizer over the polarizing slot of the housing until the latch engages the hole. Snap off the tab at the break line next to the housing. Using the remaining polarizer, repeat the process for the other housing location.

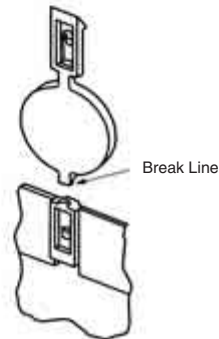



**Note:** For Post Shunts, contact Tyco Electronics.

**Note:** All part numbers are RoHS compliant.

## Locking Clip Contacts and Housings

### Product Facts

- Self-retaining contacts provide permanent connection with quick connect and disconnect
- Fast, easy installation with no additional locking hardware required
- Mates with .025 [0.64] square posts in a variety of configurations
- Single- and double-row configurations in up to 20 positions on .100 [2.54] centers
- Modular design permits end-to-end stacking (double-row only) for circuit grouping
- Choice of tin or select gold plating
- Housings made of 94V-0 rated glass-filled polyester
- Recognized under the Component Program of Underwriters Laboratories Inc., File No. E28476 
- Certified by Canadian Standards Association, File No. LR 7189 

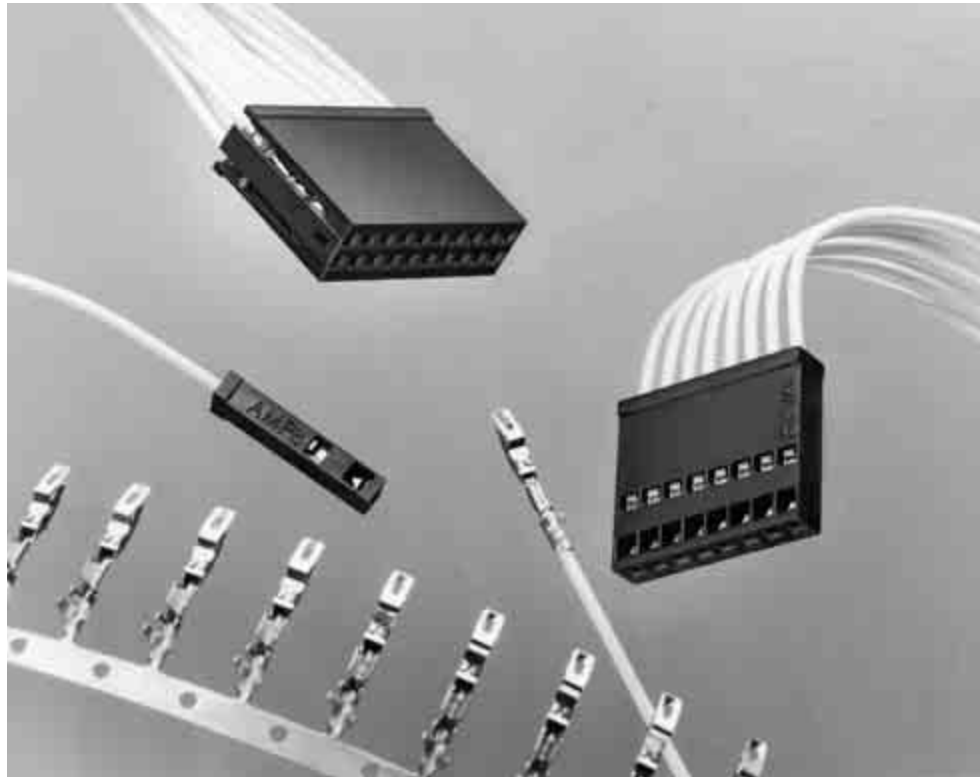

### Typical Application

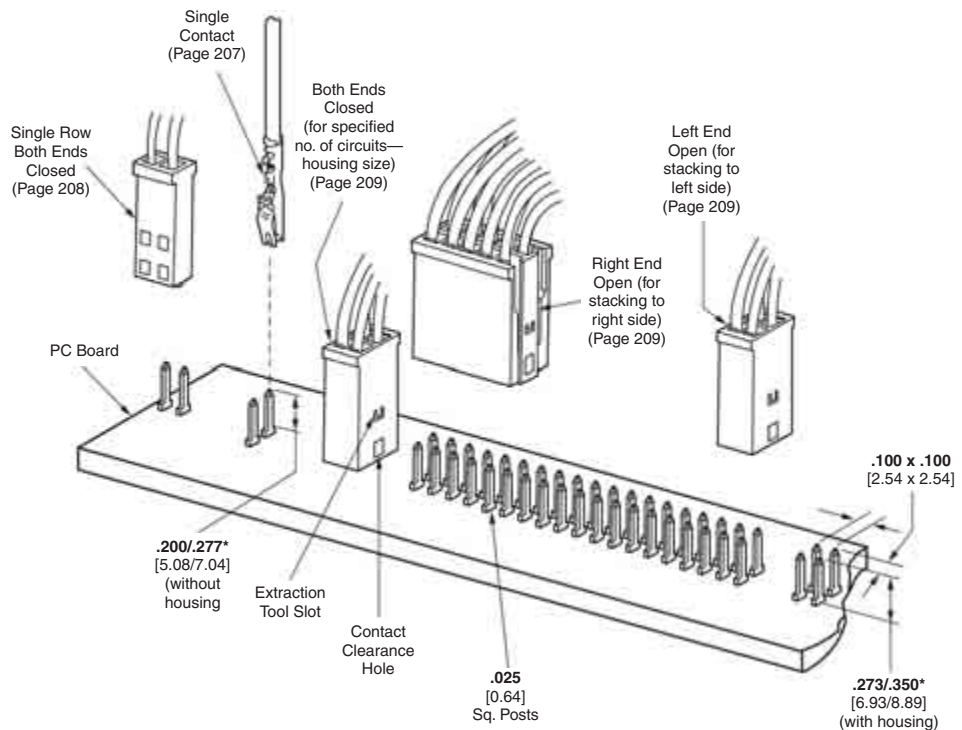

\*If post is longer than maximum specified, post tip may butt against wire ends.  
Dimension defines .025 x .025 [0.64 x 0.64] portion of post.

### Performance Characteristics

**Contact Current Rating** — 3 amperes

**Termination Resistance** — 12 milliohms (max.) — Gold plated contacts  
16 milliohms (max.) — Tin plated contacts

**Durability** — Ref. Product Specification 108-36028 and 108-36028-1



## Locking Clip Contacts

### Wire Crimp Contacts with Insulation Support

#### Material and Finish

**Contact Spring** — Stainless steel

**Plating A** — Selectively plated .000050 [0.00127] gold on contact area, with gold flash over .000050 [0.00127] nickel on entire contact

**Plating B** — Selectively plated .000030 [0.00076] gold on contact area, with gold flash over .000050 [0.00127] nickel on entire contact

**Plating C** — .000100-.000200 [0.00254-0.00508] bright tin over .000050 [0.00127] nickel on entire contact

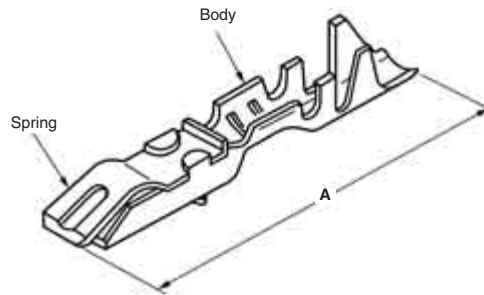

Wire Size Range		Ins. Dia. Range	Dimension A	Finish	Part Nos.		Heavy Duty Miniature Applicator for AMP-O-LECTRIC Machine*	Hand Tool No.
AWG	[mm <sup>2</sup> ]				Strip Form	Loose Piece		
30-28	0.05-0.09	.029-.039 [0.74-0.99]	.550 [13.97]	Plating B	87190-1	87191-1	567310-2	90295-1
				Plating C	5-87190-2	5-87191-2		
26-22	0.12-0.4	.038-.062 [0.97-1.57]	.584 [14.83]	Plating A	87124-3	87165-3	466721-2	91533-1
				Plating B	87124-1	87165-1		
				Plating C	5-87124-2	5-87165-2		
20	0.5-0.6	.038-.062 [0.97-1.57]	.584 [14.83]	Plating B	867052-2	—	679996-2	90431-1
				Plating C	5-867052-1	—		

\*For use with AMP-O-LECTRIC Model "K" machines. Call the Technical Support Center (1-800-522-6752) for part nos. of applicators for use with the AMP-O-LECTRIC Model "G" machines (shown on page 270), as well as other bench machines and fully automatic AMPOMATOR lead making machines.

**Notes:** 1. These contacts must be crimped in accordance with Tyco Electronics Specification No. 114-25006 in order to function properly in a connector housing.  
2. **Extraction Tool No. 91084-1** is used for removing individual contacts from connector housings and for detaching contacts from mating posts.

#### Related Product Data

**Housings Used With** — pages 208, 209

**Application Tooling** — page 272

**Technical Documents** — pages 277, 278

**Product Specification**  
108-36028, 108-36028-1

**Application Specification**  
114-25006

#### Wire Harnessing

If necessary, wires can be grouped with cable ties and secured to a panel with fixed clamps. However, locking clip contacts must be free to float within the connector housings to allow proper extraction. Therefore, harnessing hardware or the use of multiple terminations per contact must not restrict the free-floating action of contacts in the housing.

For more information request Insulation and Bundling Products Catalog 124132.

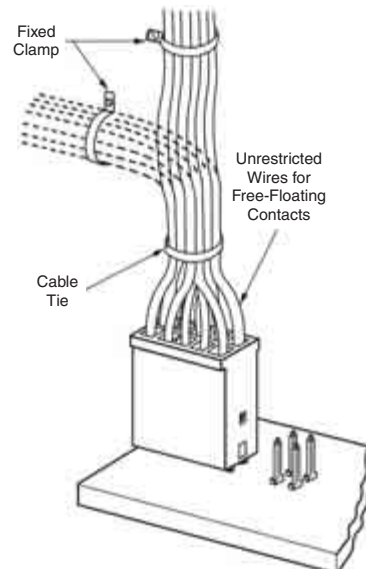

**Extraction Tool No. 91084-1**

**Note:** All part numbers are RoHS compliant.

## Wire-Applied Housings for Locking Clip Contacts, Single-Row, .100 [2.54] Centerline

### Single-Row



#### Material

Glass-filled polyester, 94V-0 rated

#### Related Product Data

**Contacts** — page 207

**Mateable Headers and Posts** — Refer to the Mating Post Selection Guide — page 90

**Technical Documents** — pages 277, 278

**Product Specification**  
108-36028, 108-36028-1

**Application Specification**  
114-25006

**.125 [3.18] centerline single-row, 2 and 3 position housings are available, Base Part No. 104905. They are designed to be stackable end-to-end and side-by-side. Consult Tyco Electronics.**



**Note:** Housing illustrated above is the "Both Ends Closed" version.

5 Locking Clip Contacts and Housings

### Keying Plug



**Part No. 87179-1**

(Plugs directly into housings for .025 [0.64] square post contacts)

**Material** — Yellow, nylon

**Note:** All part numbers are RoHS compliant.

No. of Pos.	Dimensions			Housing Part No.	
	A	B	C	Unstamped	Stamped
1	.108 [2.74]	—	.054 [1.37]	87175-2	—
2	.216 [5.49]	.100 [2.54]	.058 [1.47]	87175-6	—
3	.316 [8.03]	.200 [5.08]	.058 [1.47]	87175-8	—
4	.416 [10.57]	.300 [7.62]	.058 [1.47]	1-87175-0	—
5	.516 [13.11]	.400 [10.16]	.058 [1.47]	1-87175-2	—
6	.616 [15.65]	.500 [12.70]	.058 [1.47]	1-87175-4	1-87175-3
7	.716 [18.19]	.600 [15.24]	.058 [1.47]	1-87175-6	1-87175-5
8	.816 [20.73]	.700 [17.78]	.058 [1.47]	1-87175-8	1-87175-7
9	.916 [23.27]	.800 [20.32]	.058 [1.47]	2-87175-0	1-87175-9
10	1.016 [25.81]	.900 [22.86]	.058 [1.47]	2-87175-2	2-87175-1
11	1.116 [28.35]	1.000 [25.40]	.058 [1.47]	2-87175-4	2-87175-3
12	1.216 [30.89]	1.100 [27.94]	.058 [1.47]	2-87175-6	2-87175-5
13	1.316 [33.43]	1.200 [30.48]	.058 [1.47]	2-87175-8	2-87175-7
14	1.416 [35.97]	1.300 [33.02]	.058 [1.47]	3-87175-0	2-87175-9
15	1.516 [38.51]	1.400 [35.56]	.058 [1.47]	87175-4	87175-3

**Wire-Applied Housings for Locking Clip Contacts, Double-Row, .100 x .100 [2.54 x 2.54] Centerline**

**Double-Row**



**Material**

Glass-filled polyester, 94V-0 rated

**Related Product Data**

**Contacts** — page 207

**Mateable Headers and Posts** — Refer to the Mating Post Selection Guide — page 90

**Technical Documents** — pages 277, 278

**Product Specification**  
108-36028, 108-36028-1

**Application Specification**  
114-25006

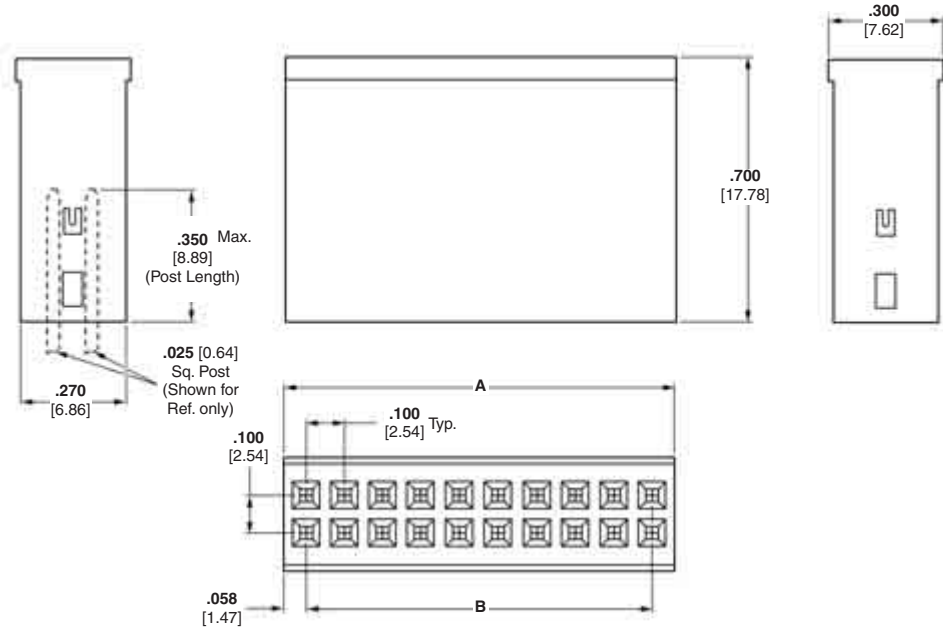

**Note:** Housing illustrated above is the "Both Ends Closed" version.

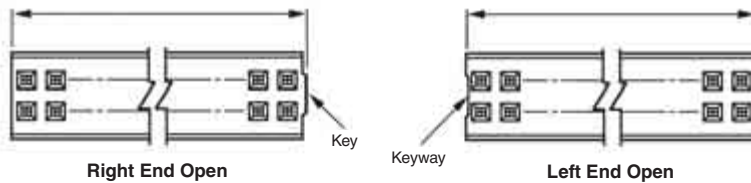
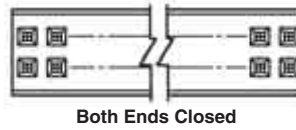

**Keying Plug**



**Part No. 87179-1**

(Plugs directly into housings for .025 [0.64] square post contacts)

**Material** — Yellow, nylon

**Note:** All part numbers are RoHS compliant.

Housing Configuration	No. of Pos.	Dimensions		Housing Part No.	
		A	B	Unstamped	Stamped
Both Ends Closed	2	.116 [2.95]	—	87176-2	—
	4	.216 [5.49]	.100 [2.54]	87133-1	—
	6	.316 [8.03]	.200 [5.08]	87133-7	87133-8
	8	.416 [10.57]	.300 [7.62]	87133-9	1-87133-0
	10	.516 [13.11]	.400 [10.16]	87133-2	87133-5
	12	.616 [15.65]	.500 [12.70]	1-87133-1	1-87133-2
	16	.816 [20.73]	.700 [17.78]	1-87133-3	1-87133-4
	18	.916 [23.27]	.800 [20.32]	1-87133-5	1-87133-6
	20	1.016 [25.81]	.900 [22.86]	87133-3	87133-6
	Right End Open	4	.216 [5.49]	.100 [2.54]	87132-1
10		.516 [13.11]	.400 [10.16]	87132-2	87132-5
20		1.016 [25.81]	.900 [22.86]	87132-3	87132-6
Left End Open	4	.216 [5.49]	.100 [2.54]	87131-1	—
	10	.516 [13.11]	.400 [10.16]	87131-2	87131-5
	20	1.016 [25.81]	.900 [22.86]	87131-3	87131-6

## Mod IV Wire-Applied Contacts and Housings

### Product Facts

- Terminates 32-20 AWG [0.03-0.6mm<sup>2</sup>] discrete wire
- Contacts have insulation support
- Choice of three contact mating pressures
- Available in a variety of gold and tin platings
- Receptacles mate with .025 [0.64] square or round posts
- Dual cantilever contact beam with built-in anti-overstress feature for reliable matings
- Housings accept a variety of receptacle and pin contacts
- Housing sizes range up to 100 positions
- Housing configurations include single- and double-rows on .100 [2.54] centerlines
- Housing options include detent latching, polarization and bonded strain relief/pull tabs
- Recognized under the Component Program of Underwriters Laboratories Inc., File No. E28476
- Certified by Canadian Standards Association, File No. LR 7189



### Performance Characteristics

**Contact Current Rating** — 3 amperes

**Termination Resistance** — 12 milliohms (max.) — Beryllium copper contacts  
20 milliohms (max.) — Copper-tin-phosphor bronze contacts

**Durability** — Ref. Product Specification 108-25020

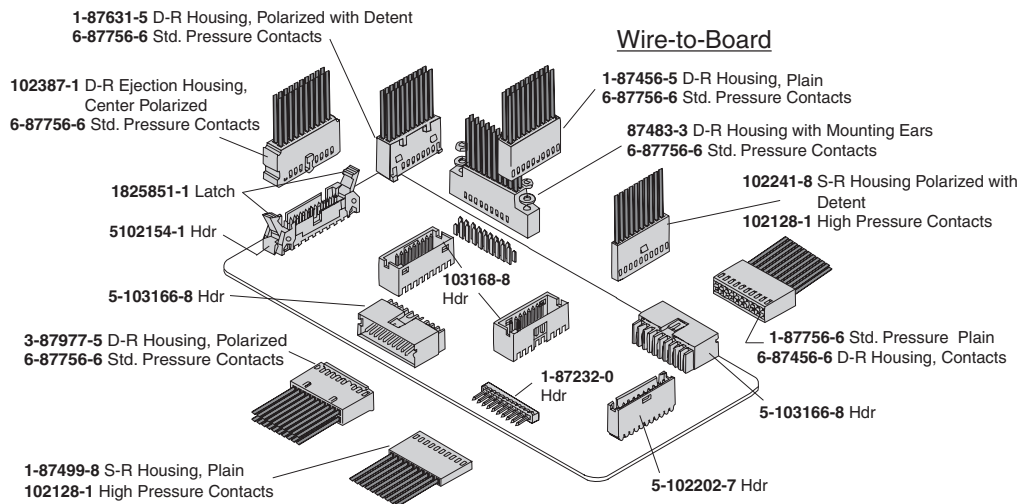
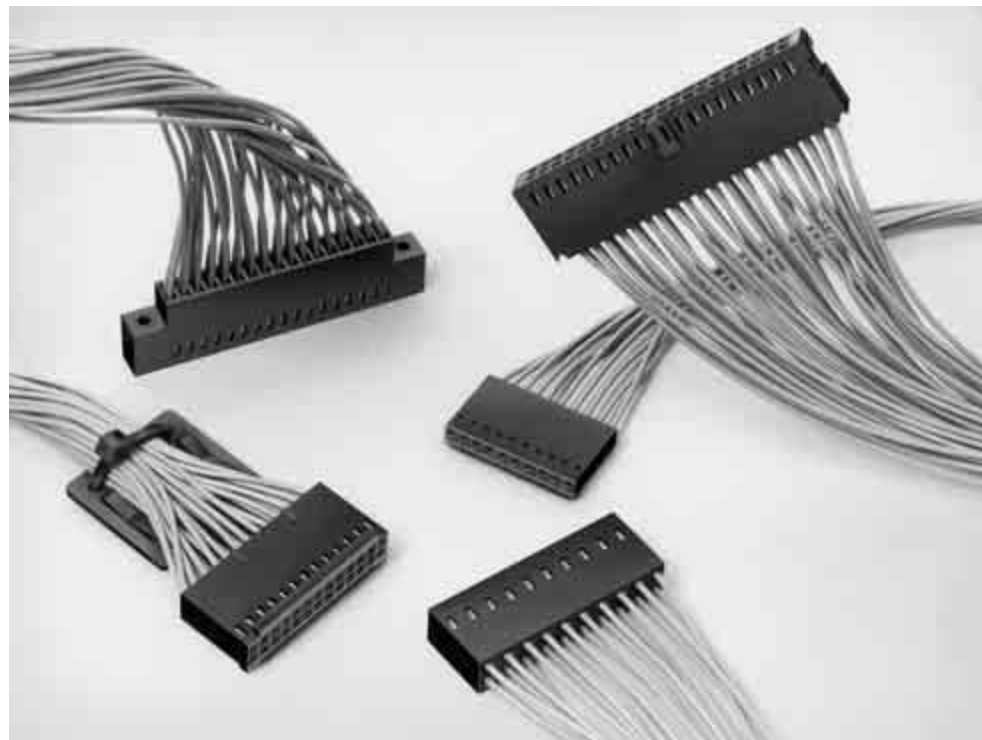

**Note:** All part numbers are RoHS compliant.

**Mod IV Pin and Receptacle Contacts**

**Crimp Snap-In (No-strip) Receptacles and Crimp Snap-In Pins with Insulation Support (Standard Pressure)**

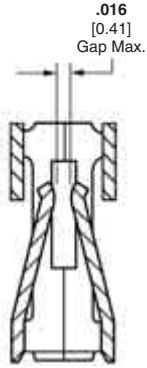

Standard Pressure Configuration

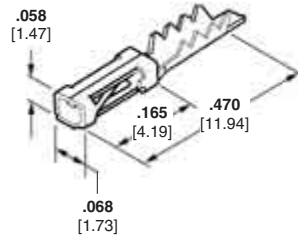

No-Strip Receptacle

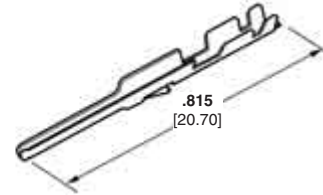

Pin with Insulation Support

**Crimp Snap-In (No-strip) Receptacles**

Ins. Dia. Range	Finish	Part Nos.		Heavy Duty Miniature Applicator No. for AMP-O-LECTRIC Machine*	Hand Tool Part No.
		Strip Form	Loose Piece		
.040-.055 [1.02-1.40]	Plating A	87107-5	102348-2	567307-2	90381-1
	Plating C	87107-6	102348-3		

**Material and Finish**

Beryllium copper, phosphor bronze, or copper-tin-phosphor bronze (see charts), plated as follows:

**Plating A** — Selectively plated .000030 [0.00076] gold on contact area, with gold flash over .000050 [0.00127] nickel on entire contact

**Plating B** — Selectively plated .000015 [0.00038] gold on contact area, with gold flash over .000050 [0.00127] nickel on entire contact

**Plating C** — .000100-.000200 [0.00254-0.00508] tin over .000030 [0.00076] nickel on entire contact

**Related Product Data**

**Housings Used With** — pages 214-220

**Performance Characteristics** — page 210

**Application Tooling** — page 270-272

**Technical Documents** — pages 276-278

**Product Specification** 108-25007, 108-25019, 108-25020, 108-25021

**Application Specification** 114-25003, 114-25016

Additional header sizes are available; minimum order quantities may apply. Consult Tyco Electronics.

**Crimp Snap-In Pins with Insulation Support**

Wire Size Range		Ins. Dia. (Max.)	Finish	Part Nos.		Heavy Duty Miniature Applicator No. for AMP-O-LECTRIC Machine*	Hand Tool Part No.	
AWG	[mm <sup>2</sup> ]			Strip Form	Loose Piece		Premium	Commercial
26-22	0.12-0.4	.061 [1.55]	Plating A	102095-3	102107-2	466812-2	91517-1	58641-1†
			Plating B	102095-2	102107-1			
			Plating C	5-102095-4	5-102107-3			

\*For use with AMP-O-LECTRIC Model "K" machines. Call the Technical Support Center (1-800-522-6752) for part nos. of applicators for use with the AMP-O-LECTRIC Model "G" machines (shown on page 270), as well as other bench machines and fully automatic AMPOMATOR lead making machines.

†PRO-CRIMPER II hand tool frame with die set assembly. Die Set Part No. 58641-2

**Note:** All part numbers are RoHS compliant.

**Mod IV Receptacle Contacts**

**Crimp Snap-In Receptacles with Insulation Support (Standard, Intermediate and High Pressure)**

**Material and Finish**

Beryllium copper, phosphor bronze or copper-tin-phosphor bronze (see charts, on following page), plated as follows:

**Plating A** — Duplex plated .000030 [0.00076] gold on contact area, .000100-.000200 [0.00254-0.00508] tin on crimp area, with entire contact underplated .000050 [0.00127] nickel

**Plating B** — Duplex plated .000015 [0.00038] gold on contact area, .000100-.000200 [0.00254-0.00508] tin on crimp area, with entire contact underplated .000050 [0.00127] nickel

**Plating D** — Selectively plated .000050 [0.00127] gold on contact area, with gold flash over .000050 [0.00127] nickel on entire contact

**Plating E** — Selectively plated .000030 [0.00076] gold on contact area, with gold flash over .000050 [0.00127] nickel on entire contact

**Plating F** — Selectively plated .000015 [0.00038] gold on contact area, with gold flash over .000050 [0.00127] nickel on entire contact

**Plating G** — .000100-.000200 [0.00254-0.00508] tin over .000030 [0.00076] nickel on entire contact

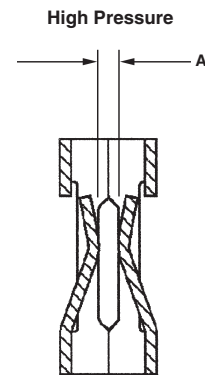
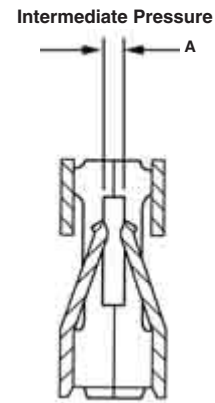

**Related Product Data**

**Housings Used With** — pages 214-220

**Performance Characteristics** — page 210

**Application Tooling** — pages 270-272

**Technical Documents** — pages 277, 278

**Product Specification**  
108-25007, 108-25019, 108-25020, 108-25021

**Application Specification**  
114-25003, 114-25016

	Mating Force	Unmating Force	A-Gap Dimension
Standard Pressure	9 oz. Max.	1.5 oz. Min.	.008/.014
Intermediate Pressure	16 oz. Max.	2 oz. Min.	.008/.014
High Pressure	20 oz. Max.	3 oz. Min.	.013±.002



### Mod IV Receptacle Contacts (Continued)

#### Standard Pressure (Mod IV)

Wire Size Range AWG [mm <sup>2</sup> ]	Ins. Dia. (Max.)	Dimension A	Material	Finish	Part Nos.		Heavy Duty Miniature Applicator for AMP-O-LECTRIC Machine*	Applicator for Stripper/Crimper Machine	Hand Tool Part Nos.	
					Strip Form	Loose Piece			Premium	Commercial
32-27 0.03-0.1	.040 [1.02]	.445 [11.30]	Cu-Sn-Ph Bz	Plating A	5-102316-8	6-102316-4	466655-2	466921-1	91541-1	—
			Cu-Sn-Ph Bz	Plating B	5-102316-6	6-102316-3				
			Be Cu	Plating D	1-102917-1	1-102917-2				
			Be Cu	Plating E	102917-1	102917-2				
			Be Cu	Plating F	102917-5	102917-6				
26-22 0.12-0.4	.061 [1.55]	.445 [11.30]	Cu-Sn-Ph Bz	Plating G	102316-5	1-102316-2	466571-2	466918-1	91517-1	58641-1†
			Cu-Sn-Ph Bz	Plating A	6-87756-7	6-87756-8				
			Cu-Sn-Ph Bz	Plating B	6-87756-2	6-87756-6				
			Cu-Sn-Ph Br	Plating G	87756-6	87756-7				
			Be Cu	Plating D	1-87666-6	87667-5				
			Be Cu	Plating E	87666-2	87667-2				
			Be Cu	Plating F	87666-5	87667-5				
			Be Cu	Plating G	87666-3	87667-3				
24-20 0.2-0.6	.069 [1.75]	.470 [11.94]	Cu-Sn-Ph Bz	Plating A	6-87523-8	6-87523-9	466562-2	466905-1	91516-1	—
			Cu-Sn-Ph Bz	Plating B	2-87523-3	2-87523-4				
			Be Cu	Plating E	85969-8	86016-2				
			Be Cu	Plating F	85969-6	86016-5				
			Cu-Sn-Ph Br	Plating G	87523-5	87523-6				
			Be Cu	Plating G	85969-9	86016-3				

#### Intermediate Pressure (Mod IV.v)

Wire Size Range AWG [mm <sup>2</sup> ]	Ins. Dia. (Max.)	Dimension A	Material	Finish	Part Nos.		Heavy Duty Miniature Applicator for AMP-O-LECTRIC Machine*	Applicator for Stripper/Crimper Machine	Hand Tool Part Nos.	
					Strip Form	Loose Piece			Premium	Commercial
32-27 0.03-0.1	.040 [1.02]	.445 [11.30]	Cu-Sn-Ph Bz	Plating A	5-102920-1	5-102920-2	466655-2	466921-1	91541-1	—
			Be Cu	Plating E	102918-1	102918-2				
26-22 0.12-0.4	.061 [1.55]	.445 [11.30]	Cu-Sn-Ph Bz	Plating A	5-103171-4	5-103171-5	466571-2	466918-1	91517-1	58641-1†
			Cu-Sn-Ph Bz	Plating B	5-103171-1	5-103171-2				
			Be Cu	Plating E	102548-5	102548-6				
24-20 0.2-0.6	.069 [1.75]	.470 [11.94]	Be Cu	Plating F	102548-1	102548-3	466562-2	466905-1	91516-1	—
			Cu-Sn-Ph Bz	Plating A	2-87195-3	2-87195-6				
			Cu-Sn-Ph Bz	Plating B	2-87195-4	2-87195-5				
			Be Cu	Plating E	86492-6	87046-3				
			Be Cu	Plating F	86492-2	87046-1				
			Be Cu	Plating G	86492-9	87046-4				

#### High Pressure (Mod V)\*\*

Wire Size Range AWG [mm <sup>2</sup> ]	Ins. Dia. (Max.)	Dimension A	Material	Finish	Part Nos.		Heavy Duty Miniature Applicator for AMP-O-LECTRIC Machine*	Applicator for AMP-O-MATIC Stripper/Crimper Machine	Hand Tool Part Nos.
					Strip Form	Loose Piece			
32-27 0.03-0.1	.040 [1.02]	.445 [11.30]	Ph Bz	Plating E	103455-1	103455-2	466655-2	466921-1	91541-1
26-22 0.12-0.4	.061 [1.55]	.445 [11.30]	Ph Bz	Plating E	87809-1	102128-1	466571-2	466918-1	91517-1
			Ph Bz	Plating G	87809-2	102128-2			
24-20 0.2-0.6	.069 [1.75]	.470 [11.94]	Ph Bz	Plating E	87309-9	1-87309-4	466562-2	466905-1	91516-1
			Ph Bz	Plating G	87309-8	1-87309-3			

\*For use with AMP-O-LECTRIC Model "K" machines. Call the Technical Support Center (1-800-522-6752) for part nos. of applicators for use with the AMP-O-LECTRIC Model "G" machines (shown on page 270), as well as other bench machines and fully automatic AMPOMATOR lead making machines.

\*\*Contact material is phosphor bronze.

†PRO-CRIMPER II hand tool frame with die set assembly.  
Die Set Part No. 58641-2

**Note:** All part numbers are RoHS compliant.

**Mod IV Wire-Applied Housings, Single-Row, .100 [2.54] Centerline**

**Non-Polarized**



**Material**

Black thermoplastic, flame retardant

**Related Product Data**

**Contacts** — pages 211-213  
**Mateable Headers and Posts** — pages 93-95, 101-103

**Technical Documents** — pages 277, 278

**Product Specification**  
 108-25007, 108-25019, 108-25020, 108-25021

**Application Specification**  
 114-25003, 114-25016



No. of Pos.	Dimensions			Part No.	
	A	B	C	Stamped*	Unstamped**
1	.105 [2.67]	—	—	—	7-87499-2
2	.205 [5.21]	.100 [2.54]	—	87499-3	87499-4
3	.305 [7.75]	.100 [2.54]	.100 [2.54]	87499-5	87499-6
4	.405 [10.29]	.200 [5.08]	.100 [2.54]	87499-7	87499-8
5	.505 [12.83]	.200 [5.08]	.200 [5.08]	87499-9	1-87499-0
6	.605 [15.37]	.300 [7.62]	.200 [5.08]	1-87499-1	1-87499-2
7	.705 [17.91]	.300 [7.62]	.300 [7.62]	87499-1	87499-2
8	.805 [20.45]	.400 [10.16]	.300 [7.62]	1-87499-3	1-87499-4
9	.905 [22.99]	.400 [10.16]	.400 [10.16]	1-87499-5	1-87499-6
10	1.005 [25.53]	.500 [12.70]	.400 [10.16]	1-87499-7	1-87499-8
11	1.105 [28.01]	.500 [12.70]	.500 [12.70]	1-87499-9	2-87499-0
12	1.205 [30.61]	.600 [15.24]	.500 [12.70]	2-87499-1	2-87499-2
13	1.305 [33.15]	.600 [15.24]	.600 [15.24]	2-87499-3	2-87499-4
14	1.405 [35.69]	.700 [17.78]	.600 [15.24]	2-87499-5	2-87499-6
15	1.505 [38.23]	.700 [17.78]	.700 [17.78]	2-87499-7	2-87499-8
16	1.605 [40.77]	.800 [20.32]	.700 [17.78]	2-87499-9	3-87499-0
17	1.700 [43.18]	.800 [20.32]	.800 [20.32]	—	3-87499-2
18	1.805 [45.85]	.900 [22.86]	.800 [20.32]	—	3-87499-4
19	1.900 [48.26]	.900 [22.86]	.900 [22.86]	—	3-87499-6
20	2.005 [50.93]	1.000 [25.40]	.900 [22.86]	3-87499-7	3-87499-8
21	2.100 [53.34]	1.000 [25.40]	1.000 [25.40]	—	4-87499-0
22	2.205 [56.01]	1.100 [27.94]	1.000 [25.40]	—	4-87499-2
23	2.300 [58.42]	1.100 [27.94]	1.100 [27.94]	—	4-87499-4
24	2.400 [60.96]	1.200 [30.48]	1.100 [27.94]	—	4-87499-6
25	2.500 [63.50]	1.200 [30.48]	1.200 [30.48]	—	4-87499-8
26	2.605 [66.17]	1.300 [33.02]	1.200 [30.48]	—	5-87499-0
27	2.700 [68.58]	1.300 [33.02]	1.300 [33.02]	—	5-87499-2
28	2.800 [71.12]	1.400 [35.56]	1.300 [33.02]	—	5-87499-4
29	2.900 [73.66]	1.400 [35.56]	1.400 [35.56]	—	5-87499-6
30	3.005 [76.33]	1.500 [38.10]	1.400 [35.56]	—	5-87499-8
31	3.100 [78.74]	1.500 [38.10]	1.500 [38.10]	—	6-87499-0
32	3.200 [81.28]	1.600 [40.64]	1.500 [38.10]	—	6-87499-2
33	3.300 [83.82]	1.600 [40.64]	1.600 [40.64]	—	6-87499-4
34	3.400 [86.36]	1.700 [43.18]	1.600 [40.64]	—	6-87499-6
35	3.500 [88.98]	1.700 [43.18]	1.700 [43.18]	—	6-87499-8
36	3.600 [91.44]	1.800 [45.72]	1.700 [43.18]	—	7-87499-0

\*Cavity identification, part number and date code stamped on housing where size permits.

\*\*No marking on housing.

**Notes:** 1. Strain reliefs are available and may be purchased separately. Consult Tyco Electronics.  
 2. Contact **Extraction/Lance Reset Tool No. 843996-3**.

**Note:** All part numbers are RoHS compliant.

**Keying Plugs**



**Part No. 86286-1**

(Plugs into standard or intermediate pressure receptacle contact)

**Material** — Natural color nylon



**Part No. 87077-2**

(Plugs directly into housing)

**Mod IV Wire-Applied Housings, Single-Row, .100 [2.54] Centerline** (Continued)

**Polarized (with Detent Latching)**



**Material**

Black thermoplastic, flame retardant

**Related Product Data**

- Contacts** — pages 211-213
- Mateable Headers and Posts** — pages 115, 116
- Flexible Film Connectors, Single-Row Pin Assemblies** — Catalog 82007

**Technical Documents** — pages 277, 278

**Product Specification**  
108-25007, 108-25019, 108-25020, 108-25021

**Application Specification**  
114-25003, 114-25016

**Keying Plugs**



**Part No. 86286-1**  
(Plugs into standard or intermediate pressure receptacle contact)

**Material** — Natural color nylon



**Part No. 87077-2**  
(Plugs directly into housing)

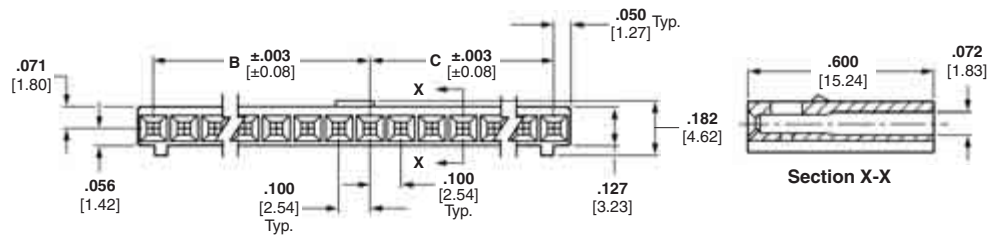
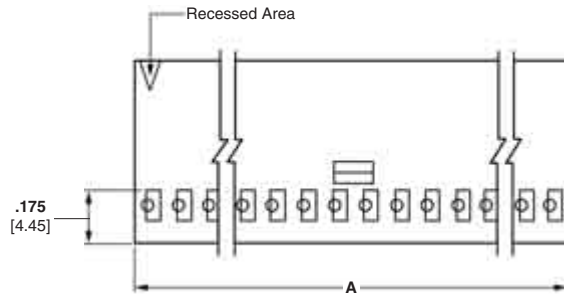

No. of Pos.	Dimensions			Part Nos. Unstamped*
	A	B	C	
3	.300 [7.62]	.100 [2.54]	.100 [2.54]	102241-1
4	.400 [10.16]	.200 [5.08]	.100 [2.54]	102241-2
5	.500 [12.70]	.200 [5.08]	.200 [5.08]	102241-3
6	.600 [15.24]	.300 [7.62]	.200 [5.08]	102241-4
7	.700 [17.78]	.300 [7.62]	.300 [7.62]	102241-5
8	.800 [20.32]	.400 [10.16]	.300 [7.62]	102241-6
9	.900 [22.86]	.400 [10.16]	.400 [10.16]	102241-7
10	1.000 [25.40]	.500 [12.70]	.400 [10.16]	102241-8
11	1.100 [27.94]	.500 [12.70]	.500 [12.70]	102241-9
12	1.200 [30.48]	.600 [15.24]	.500 [12.70]	1-102241-0
13	1.300 [33.02]	.600 [15.24]	.600 [15.24]	1-102241-1
14	1.400 [35.56]	.700 [17.78]	.600 [15.24]	1-102241-2
15	1.500 [38.10]	.700 [17.78]	.700 [17.78]	1-102241-3
16	1.600 [40.64]	.800 [20.32]	.700 [17.78]	1-102241-4
17	1.700 [43.18]	.800 [20.32]	.800 [20.32]	1-102241-5
18	1.800 [45.72]	.900 [22.86]	.800 [20.32]	1-102241-6
19	1.900 [48.26]	.900 [22.86]	.900 [22.86]	1-102241-7
20	2.000 [50.80]	1.000 [25.40]	.900 [22.86]	1-102241-8
21	2.100 [53.34]	1.000 [25.40]	1.000 [25.40]	1-102241-9
22	2.200 [55.88]	1.100 [27.94]	1.000 [25.40]	2-102241-0
23	2.300 [58.42]	1.100 [27.94]	1.100 [27.94]	2-102241-1
24	2.400 [60.96]	1.200 [30.48]	1.100 [27.94]	2-102241-2
25	2.500 [63.50]	1.200 [30.48]	1.200 [30.48]	2-102241-3
26	2.600 [66.04]	1.300 [33.02]	1.200 [30.48]	2-102241-4
27	2.700 [68.58]	1.300 [33.02]	1.300 [33.02]	2-102241-5
28	2.800 [71.12]	1.400 [35.56]	1.300 [33.02]	2-102241-6
29	2.900 [73.66]	1.400 [35.56]	1.400 [35.56]	2-102241-7
30	3.000 [76.20]	1.500 [38.10]	1.400 [35.56]	2-102241-8
31	3.100 [78.74]	1.500 [38.10]	1.500 [38.10]	2-102241-9
32	3.200 [81.28]	1.600 [40.64]	1.500 [38.10]	3-102241-0
33	3.300 [83.82]	1.600 [40.64]	1.600 [40.64]	3-102241-1
34	3.400 [86.36]	1.700 [43.18]	1.600 [40.64]	3-102242-2
35	3.500 [88.90]	1.700 [43.18]	1.700 [43.18]	3-102241-3
36	3.600 [91.44]	1.800 [45.72]	1.700 [43.18]	3-102241-4

\*No marking on housing.  
**Note:** Contact Extraction/Lance Reset Tool No. 843996-3.

**Note:** All part numbers are RoHS compliant.

**Mod IV Wire-Applied Housings, Double-Row,  
.100 x .100 [2.54 x 2.54] Centerline**

**Non-Polarized**

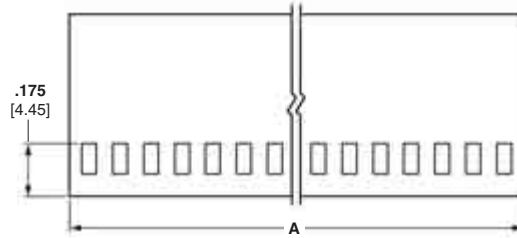

**Material**

Black thermoplastic, flame retardant

**Related Product Data**

**Contacts** — pages 211-213  
**Mateable Headers and Posts** —  
pages 96-99, 104, 105, 117-120

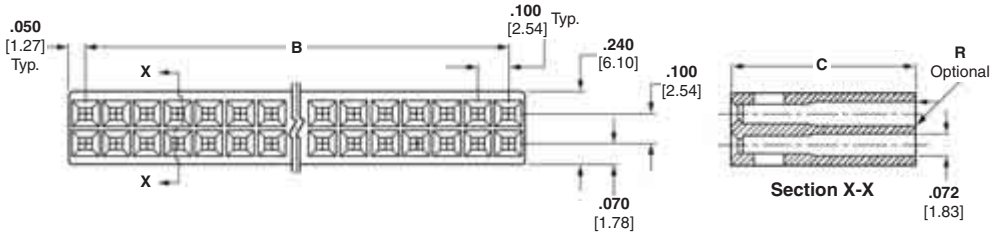

**Technical Documents** —  
pages 277, 278

**Product Specification**  
108-25007, 108-25019, 108-25020,  
108-25021

**Application Specification**  
114-25003, 114-25016

**Keying Plugs**



**Part No. 86286-1**

(Plugs into standard or intermediate pressure receptacle contact)

**Material** — Natural color nylon



**Part No. 87077-1**

(for .645 high housings)

**Part No. 87077-2**

(for .600 high housings)

(Plugs directly into housing)

No. of Pos.	Dimensions		Part Nos.		
	A	B	C = .600 [15.24]		C = .645 [16.38]
			Stamped*	Unstamped**	Unstamped**
2	.100 [2.54]	—	—	5-87456-3	—
4	.200 [5.08]	.100 [2.54]	5-87456-0	4-87456-9	2-86177-5
6	.300 [7.62]	.200 [5.08]	87456-2	87456-1	1-86177-8
8	.400 [10.16]	.300 [7.62]	87456-4	87456-3	2-86177-0
10	.500 [12.70]	.400 [10.16]	87456-6	87456-5	1-86177-2
12	.600 [15.24]	.500 [12.70]	87456-8	87456-7	1-86177-3
14	.700 [17.78]	.600 [15.24]	1-87456-0	87456-9	1-86177-4
16	.800 [20.32]	.700 [17.78]	1-87456-2	1-87456-1	1-86177-5
18	.900 [22.86]	.800 [20.32]	1-87456-4	1-87456-3	1-86177-6
20	1.000 [25.40]	.900 [22.86]	1-87456-6	1-87456-5	86177-1
22	1.100 [27.94]	1.000 [25.40]	—	1-87456-7	86177-2
24	1.200 [30.48]	1.100 [27.94]	2-87456-0	1-87456-9	86177-3
26	1.300 [33.02]	1.200 [30.48]	2-87456-2	2-87456-1	86177-4
28	1.400 [35.56]	1.300 [33.02]	2-87456-4	2-87456-3	86177-5
30	1.500 [38.10]	1.400 [35.56]	2-87456-6	2-87456-5	86177-6
32	1.600 [40.64]	1.500 [38.10]	2-87456-8	2-87456-7	86177-7
34	1.700 [43.18]	1.600 [40.64]	3-87456-0	2-87456-9	86177-8
36	1.800 [45.72]	1.700 [43.18]	3-87456-2	3-87456-1	86177-9
38	1.900 [48.26]	1.800 [45.72]	—	3-87456-3	1-86177-0
40	2.000 [50.80]	1.900 [48.26]	3-87456-6	3-87456-5	1-86177-1
42	2.100 [53.34]	2.000 [50.80]	4-87456-4	4-87456-3	—
44	2.200 [55.88]	2.100 [53.34]	3-87456-8	3-87456-7	1-86177-7
48	2.400 [60.96]	2.300 [58.42]	6-87456-0	5-87456-9	2-86177-3
50	2.500 [63.50]	2.400 [60.96]	4-87456-0	3-87456-9	2-86177-1
52	2.600 [66.04]	2.500 [63.50]	4-87456-2	4-87456-1	1-86177-9
54	2.700 [68.58]	2.600 [66.04]	—	4-87456-5	—
56	2.800 [71.12]	2.700 [68.58]	—	6-87456-1	—
58	2.900 [73.66]	2.800 [71.12]	—	6-87456-3	—
60	3.000 [76.20]	2.900 [73.66]	5-87456-2	5-87456-1	—
64	3.200 [81.28]	3.100 [78.74]	6-87456-6	6-87456-5	—
66	3.300 [83.82]	3.200 [81.28]	5-87456-4	5-87456-7	—
70	3.500 [88.90]	3.400 [86.36]	—	5-87456-5	2-86177-4
72	3.600 [91.44]	3.500 [88.90]	4-87456-8	4-87456-7	—

\*Cavity identification, part number and date code stamped on housing where size permits.

\*\*No marking on housing.

**Notes:** 1. Strain reliefs are available and may be purchased separately. Consult Tyco Electronics.

2. Contact **Extraction/Lance Reset Tool No. 843996-3**.

**Note:** All part numbers are RoHS compliant.

**Mod IV Wire-Applied Housings, Double-Row, .100 x .100 [2.54 x 2.54] Centerline** (Continued)

**Polarized**



**Material**

Black thermoplastic, flame retardant

**Related Product Data**

**Contacts** — pages 211-213  
**Mateable Headers and Posts** — pages 117-131

**Technical Documents** — pages 277, 278

**Product Specification**  
 108-25007, 108-25019, 108-25020, 108-25021

**Application Specification**  
 114-25003, 114-25016



No. of Pos.	Dimensions			Part Nos.	
	A	B	C	Stamped*	Unstamped**
6	.300 [7.62]	.100 [2.54]	.100 [2.54]	87977-1	2-87977-8
8	.400 [10.16]	.200 [5.08]	.100 [2.54]	87977-2	2-87977-9
10	.500 [12.70]	.200 [5.08]	.200 [5.08]	87977-3	3-87977-0
12	.600 [15.24]	.300 [7.62]	.200 [5.08]	87977-4	3-87977-1
14	.700 [17.78]	.300 [7.62]	.300 [7.62]	87977-5	3-87977-2
16	.800 [20.32]	.400 [10.16]	.300 [7.62]	87977-6	3-87977-3
18	.900 [22.86]	.400 [10.16]	.400 [10.16]	—	3-87977-4
20	1.000 [25.40]	.500 [12.70]	.400 [10.16]	87977-8	3-87977-5
22	1.100 [27.94]	.500 [12.70]	.500 [12.70]	—	3-87977-6
24	1.200 [30.48]	.600 [15.24]	.500 [12.70]	1-87977-0	3-87977-7
26	1.300 [33.02]	.600 [15.24]	.600 [15.24]	1-87977-1	3-87977-8
28	1.400 [35.56]	.700 [17.78]	.600 [15.24]	—	3-87977-9
30	1.500 [38.10]	.700 [17.78]	.700 [17.78]	—	4-87977-0
32	1.600 [40.64]	.800 [20.32]	.700 [17.78]	—	4-87977-1
34	1.700 [43.18]	.800 [20.32]	.800 [20.32]	—	4-87977-2
36	1.800 [45.72]	.900 [22.86]	.800 [20.32]	—	4-87977-3
38	1.900 [48.26]	.900 [22.86]	.900 [22.86]	—	4-87977-4
40	2.000 [50.80]	1.000 [25.40]	.900 [22.86]	1-87977-8	4-87977-5
42	2.100 [53.34]	1.000 [25.40]	1.000 [25.40]	—	4-87977-6
44	2.200 [55.88]	1.100 [27.94]	1.000 [25.40]	—	4-87977-7
48	2.400 [60.96]	1.200 [30.48]	1.100 [27.94]	—	5-87977-6
50	2.500 [63.50]	1.200 [30.48]	1.200 [30.48]	2-87977-1	4-87977-8
52	2.600 [66.04]	1.300 [33.02]	1.200 [30.48]	—	4-87977-9
54	2.700 [68.58]	1.300 [33.02]	1.300 [33.02]	—	5-87977-0
56	2.800 [71.12]	1.400 [35.56]	1.300 [33.02]	—	5-87977-8
58	2.900 [73.66]	1.400 [35.56]	1.400 [35.56]	—	6-87977-0
60	3.000 [76.20]	1.500 [38.10]	1.400 [35.56]	2-87977-4	5-87977-1
64	3.200 [81.28]	1.600 [40.64]	1.500 [38.10]	—	6-87977-2
66	3.300 [83.82]	1.600 [40.64]	1.600 [40.64]	—	5-87977-2
70	3.500 [88.90]	1.700 [43.18]	1.700 [43.18]	—	5-87977-3
72	3.600 [91.44]	1.800 [45.72]	1.700 [43.18]	—	5-87977-4

\*Cavity identification, part number and date code stamped on housing where size permits.

\*\*No marking on housing or strain relief.

**Notes:** 1. Strain reliefs are available and may be purchased separately. Consult Tyco Electronics.  
 2. Contact **Extraction/Lance Reset Tool No. 843996-3**.

**Note:** All part numbers are RoHS compliant.

**Keying Plugs**



**Part No. 86286-1**

(Plugs into standard or intermediate pressure receptacle contact)

**Material** — Natural color nylon



**Part No. 87077-2**

(Plugs directly into housing)



**Mod IV Wire-Applied Housings, Double-Row, .100 x .100 [2.54 x 2.54] Centerline** (Continued)

**Polarized (with Detent Latching, with and without Strain Relief/Pull Tab)**



**Material**

Black thermoplastic, flame retardant

**Related Product Data**

**Contacts** — pages 211-213  
**Mateable Headers and Posts** — pages 117-125, 127-133

**Technical Documents** — pages 277, 278

**Product Specification**  
 108-25007, 108-25019, 108-25020, 108-25021

**Application Specification**  
 114-25003, 114-25016

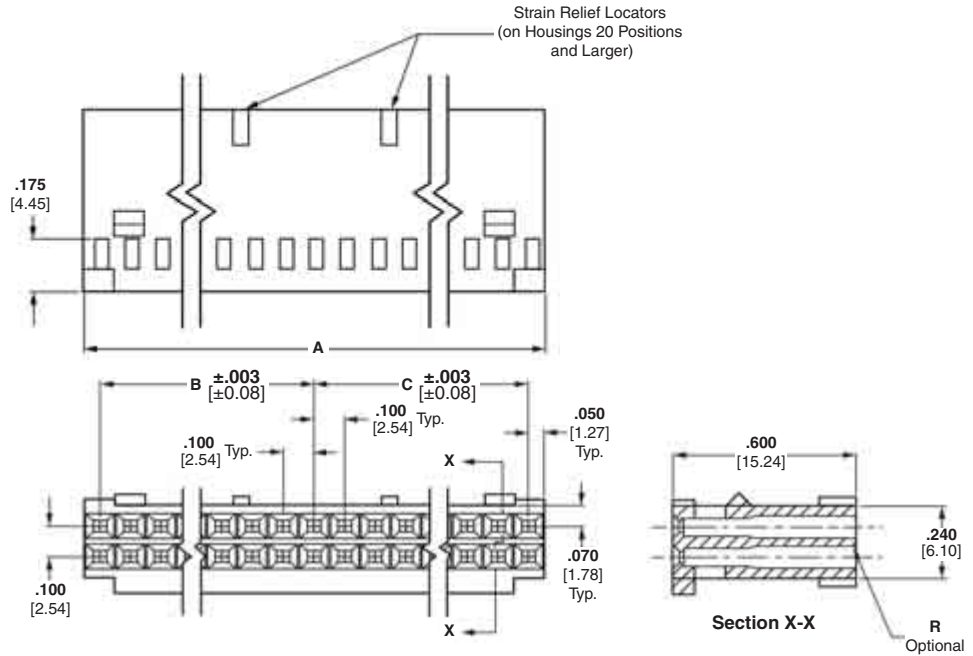

**Housing with Strain Relief/Pull Tab**  
 Strain Relief Part No. 87921-1  
 (10 thru 18 positions)

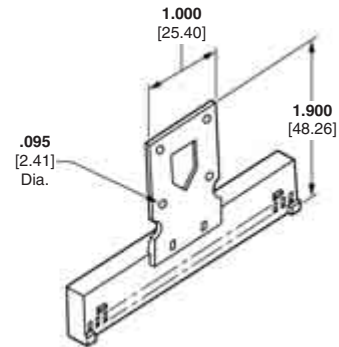

**Housing with Strain Relief/Pull Tab**  
 Strain Relief Part No. 87710-1  
 (20 positions and larger)

**Keying Plugs**



**Part No. 86286-1**  
 (Plugs into standard or intermediate pressure receptacle contact)

**Material** — Natural color nylon



**Part No. 87077-2**  
 (Plugs directly into housing)

No. of Pos.	Dimensions			No. of Detents	Part Nos.		
	A	B	C		Without Strain Relief		With Strain Relief
					Stamped*	Unstamped**	
6	.300 [7.62]	.100 [2.54]	.100 [2.54]	1	87631-2	87631-1	—
8	.400 [10.16]	.200 [5.08]	.100 [2.54]	1	87631-4	87631-3	—
10	.500 [12.70]	.200 [5.08]	.200 [5.08]	1	87631-6	87631-5	87922-1
12	.600 [15.24]	.300 [7.62]	.200 [5.08]	1	87631-8	87631-7	87922-2
14	.700 [17.78]	.300 [7.62]	.300 [7.62]	1	1-87631-0	87631-9	87922-3
16	.800 [20.32]	.400 [10.16]	.300 [7.62]	1	1-87631-2	1-87631-1	87922-4

\*Cavity identification, part number and date code stamped on housing and/or strain relief where size permits.

\*\*No marking on housing or strain relief.

- Notes:**
1. The Strain Relief/Pull Tab can be bonded to any thermoplastic connector housing.
  2. Strain reliefs may be purchased separately.
  3. Contact **Extraction/Lance Reset Tool No. 843996-3**.

**Note:** All part numbers are RoHS compliant.



## Mod IV Wire-Applied Housings, Double-Row, .100 x .100 [2.54 x 2.54] Centerline (Continued)

No. of Pos.	Dimensions			No. of Detents	Part Nos.		
	A	B	C		Without Strain Relief		With Strain Relief
					Stamped*	Unstamped**	Stamped*
18	.900 [22.86]	.400 [10.16]	.400 [10.16]	1	1-87631-4	1-87631-3	87922-5
20	1.000 [25.40]	.500 [12.70]	.400 [10.16]	2	1-87631-6	1-87631-5	87733-1
22	1.100 [27.94]	.500 [12.70]	.500 [12.70]	2	1-87631-8	1-87631-7	—
24	1.200 [30.48]	.600 [15.24]	.500 [12.70]	2	2-87631-0	1-87631-9	87733-3
26	1.300 [33.02]	.600 [15.24]	.600 [15.24]	2	2-87631-2	2-87631-1	87733-4
28	1.400 [35.56]	.700 [17.78]	.600 [15.24]	2	2-87631-4	2-87631-3	—
30	1.500 [38.10]	.700 [17.78]	.700 [17.78]	2	2-87631-6	2-87631-5	87733-6
32	1.600 [40.64]	.800 [20.32]	.700 [17.78]	2	2-87631-8	2-87631-7	87733-7
34	1.700 [43.18]	.800 [20.32]	.800 [20.32]	2	3-87631-0	2-87631-9	87733-8
36	1.800 [45.72]	.900 [22.86]	.800 [20.32]	2	3-87631-2	3-87631-1	—
38	1.900 [48.26]	.900 [22.86]	.900 [22.86]	2	—	3-87631-3	—
40	2.000 [50.80]	1.000 [25.40]	.900 [22.86]	2	3-87631-6	3-87631-5	1-87733-1
42	2.100 [53.34]	1.000 [25.40]	1.000 [25.40]	2	3-87631-8	3-87631-7	—
44	2.200 [55.88]	1.100 [27.94]	1.000 [25.40]	2	4-87631-0	3-87631-9	—
48	2.400 [60.96]	1.200 [30.48]	1.100 [27.94]	2	—	5-87631-9	—
50	2.500 [63.50]	1.200 [30.48]	1.200 [30.48]	2	4-87631-2	4-87631-1	1-87733-4
52	2.600 [66.04]	1.300 [33.02]	1.200 [30.48]	2	—	4-87631-3	—
54	2.700 [68.58]	1.300 [33.02]	1.300 [33.02]	2	4-87631-6	4-87631-5	—
58	2.900 [73.66]	1.400 [35.56]	1.400 [35.56]	2	—	6-87631-3	—
60	3.000 [76.20]	1.500 [38.10]	1.400 [35.56]	2	5-87631-2	5-87631-1	1-87733-7
64	3.200 [81.28]	1.600 [40.64]	1.500 [38.10]	2	6-87631-6	6-87631-5	—
66	3.300 [83.82]	1.600 [40.64]	1.600 [40.64]	2	—	5-87631-3	—
70	3.500 [88.90]	1.700 [43.18]	1.700 [43.18]	2	—	5-87631-5	—
72	3.800 [96.52]	1.800 [45.72]	1.700 [43.18]	2	5-87631-8	5-87631-7	—

\*Cavity identification, part number and date code stamped on housing and/or strain relief where size permits.

\*\*No marking on housing or strain relief.

- Notes:**
1. The Strain Relief/Pull Tab can be bonded to any thermoplastic connector housing.
  2. Strain reliefs may be purchased separately.
  3. Contact **Extraction/Lance Reset Tool No. 843996-3**.

**Note:** All part numbers are RoHS compliant.

**Mod IV Wire-Applied Housings, Double-Row, .100 x .100 [2.54 x 2.54] Centerline** (Continued)

**Center Polarized**



**Material**

Black thermoplastic, flame retardant

**Related Product Data**

**Contacts** — pages 211-213  
**Mateable Headers and Posts** —  
**AMP-LATCH Low Profile Headers, Shrouded** — pages 135-140

**Technical Documents** —  
 pages 277, 278

**Product Specification**  
 108-25007, 108-25019, 108-25020,  
 108-25021

**Application Specification**  
 114-25003, 114-25016

Position No. 1 Indicator

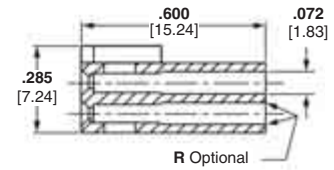
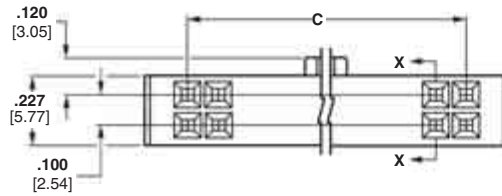
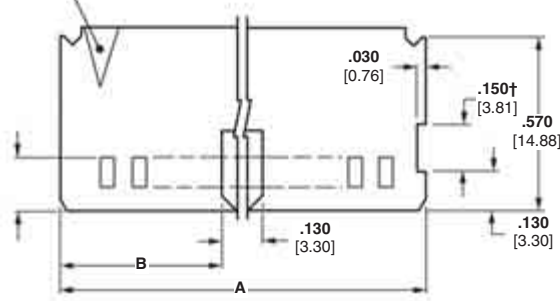

Section X-X

No. of Pos.	Dimensions			Part Nos. (Stamped*)
	A	B	C	
8	.580 [14.73]	.225 [5.72]	.300 [7.62]	1-102387-4
10	.680 [17.27]	.275 [6.98]	.400 [10.16]	102387-1
14	.880 [22.35]	.375 [9.53]	.600 [15.24]	102387-2
16	.980 [24.89]	.425 [10.80]	.700 [17.78]	102387-3
20	1.180 [29.97]	.525 [13.34]	.900 [22.86]	102387-4
22	1.280 [32.51]	.575 [14.61]	1.000 [25.40]	1-102387-5
24	1.380 [35.05]	.625 [15.88]	1.100 [27.94]	102387-5
26	1.480 [37.59]	.675 [17.15]	1.200 [30.48]	102387-6
30	1.680 [42.67]	.775 [19.69]	1.400 [35.56]	102387-7
34	1.880 [47.75]	.875 [22.23]	1.600 [40.64]	102387-8
40	2.180 [55.37]	1.025 [26.04]	1.900 [48.26]	102387-9
44	2.380 [60.45]	1.125 [28.58]	2.100 [53.34]	1-102387-3
50	2.680 [68.07]	1.275 [32.39]	2.400 [60.96]	1-102387-0
60	3.180 [80.77]	1.525 [38.74]	2.900 [73.66]	1-102387-1
64	3.380 [85.85]	1.625 [41.28]	3.100 [78.74]	1-102387-2

\*Cavity identification and Tyco Electronics stamped on housing.

†Non-functional slot is used for gating purposes during injection molding process. This gating feature is not inherent in all production molds. Therefore, the depicted slot will only be present on housings produced on mold tooling requiring this gating feature.

**Note:** Contact **Extraction/Lance Reset Tool No. 843996-3**.

**Keying Plugs**



**Part No. 86286-1**

(Plugs into standard or intermediate pressure receptacle contact)

**Material** — Natural color nylon



**Part No. 87077-2**

(Plugs directly into housing)

**Note:** All part numbers are RoHS compliant.

## Short Point, Crimp Snap-In Wire-Applied Contacts and Housings

### Product Facts

- Short point of contact mates with .169 [4.29] to .259 [6.58] long post
- Double-row housings are end-to-end and side-to-side stackable
- Terminates 32-20 AWG [0.03-0.6 mm<sup>2</sup>] discrete wire
- Contacts have insulation support to accept a maximum insulation diameter of .060 [1.52]
- Available with .000015 [0.00038] or .000030 [0.00076] gold duplex, or tin plating
- Mates with .025 [0.64] square posts
- Dual cantilever contact beams for reliable matings
- Locking retention latch provides approximately 3 lb [13.34 N] of retention force
- Unique locking latch design helps prevent latch from protruding through latch window
- Contacts snap into AMPMODU MTE single-row housings
- Double-row housing configurations include .100 [2.54] centerline, plain and polarized
- Housing sizes range from 4 to 52 positions

■ Recognized under the Component Program of Underwriters Laboratories Inc., File No. E28476



■ Certified by Canadian Standards Association, File No. LR7189



■ Produced under a Quality Management System certified to ISO 9001

A copy of the certificate is available upon request

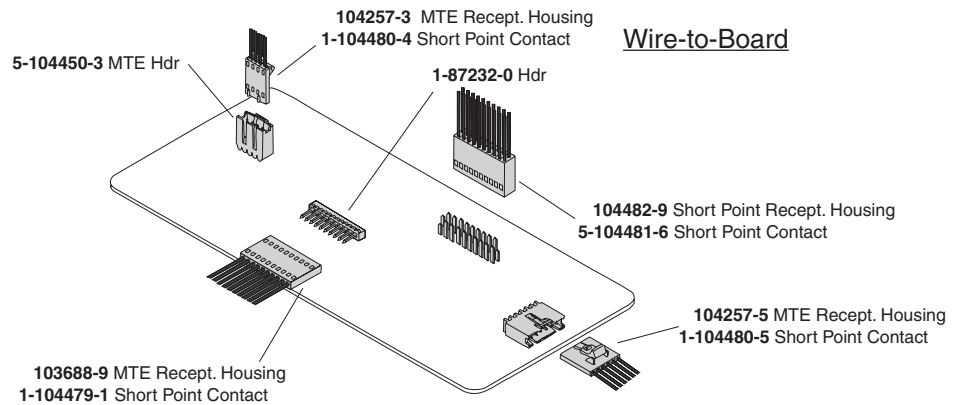
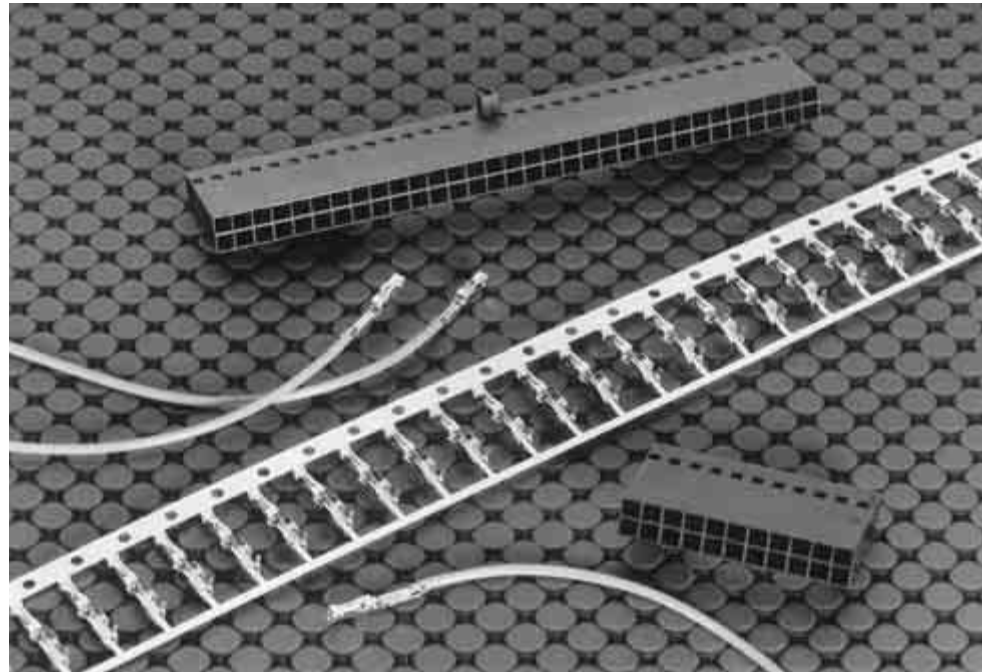

AMPMODU Short Point receptacle contacts are designed to mate with .025 [0.64] square posts. They will mate with posts as short as .169 [4.29].

Short Point double-row housings are end-to-end and side-to-side stackable on .100 [2.54] centers. Contacts also can be used in single-row AMPMODU MTE housings to provide a complete wire-crimp system, or to serve as replacement contacts.

### Performance Characteristics

- Contact Current Rating** — 3 amperes
- Termination Resistance** — 12 milliohms (max.)
- Durability** — Ref. Product Specification 108-1472

**Note:** All part numbers are RoHS compliant.

## Short Point Crimp Snap-In Receptacle Contacts

### Material and Finish

Copper alloy C7025, plated as follows:

**Plating A** — Duplex plated .000030 [0.00076] min. gold on contact area, .000050 [0.00127] min. tin in crimp area, with entire contact underplated .000050 [0.00127] min. nickel

**Plating B** — Duplex plated .000015 [0.00038] min. gold on contact area, .000050 [0.00127] min. tin in crimp area, with entire contact underplated .000050 [0.00127] min. nickel

**Plating C** — .000100 [0.00254] min. tin over .000050 [0.00127] min. nickel on entire contact

### Related Product Data

**Performance Characteristics** — page 221

**Housings used in** — Short Point—pages 223, 224

**AMPMODU MTE Unloaded Housings** — pages 228-233

**Application Tooling** — page 270-272

**Technical Documents** — pages 276-278

**Product Specification** 108-1472

**Application Specification** 114-25038

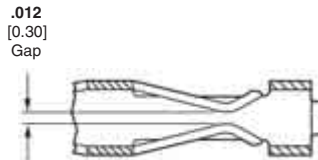
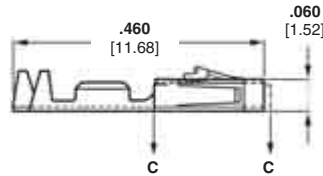
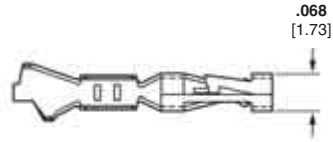

Section C - C



**Keying Plug**  
Part No. 104072-1

Ten plugs are supplied per strip. Order quantity reflects the number of strips required.



**Extraction/Lance Reset**  
Tool No. 843477-1

Wire Size Range		Ins. Dia. Range	Finish	Contact Part No. (Standard Pressure)		Quick-Change Applicator for AMP-O-LECTRIC Machine*	Applicator for AMP-O-MATIC Stripper/Crimper Machine	Hand Tool Nos.
AWG	[mm <sup>2</sup> ]			Strip Form	Loose Piece			
32-28	0.03-0.08	.025-.060 [0.64-1.52]	Plating A	1-104481-1	1-104481-3	567296-2	466980-1	91518-1
			Plating B	1-104481-0	1-104481-2			
			Plating C	5-104481-2	5-104481-6			
26-22	0.13-0.3	.025-.060 [0.64-1.52]	Plating A	1-104480-3	1-104480-6	567297-2	466981-1	91518-1
			Plating B	1-104480-2	1-104480-5			
			Plating C	1-104480-7	1-104480-4			
24-20	0.2-0.5	.025-.060 [0.64-1.52]	Plating A	1-104479-0	1-104479-3	567298-2	466982-1	91551-1
			Plating B	104479-9	1-104479-2			
			Plating C	104479-8	1-104479-1			

\*For use with Model "K" machines. Call the Tooling/Technical Assistance Center (1-800-722-1111) for part nos. of applicators for use with the Model "G" machines (shown on page 288), as well as other bench machines and fully automatic AMPOMATOR lead making machines.

**Note:** All part numbers are RoHS compliant.

**Short Point Wire-Applied Housings, Double-Row, Non-Polarized,  
.100 x .100 [2.54 x 2.54] Centerline**

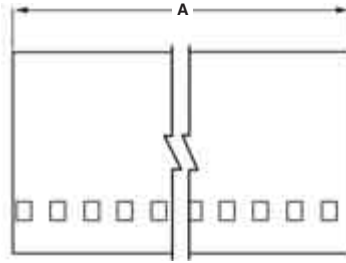

**Material**

Black thermoplastic, flame retardant,  
94V-0 rated

**Related Product Data**

**Performance Characteristics** —  
page 221

**Contacts** — page 222

**Mateable Headers** —  
pages 104, 105

**Technical Documents** —  
pages 276-278

**Product Specification**  
108-1472

**Application Specification**  
114-25038

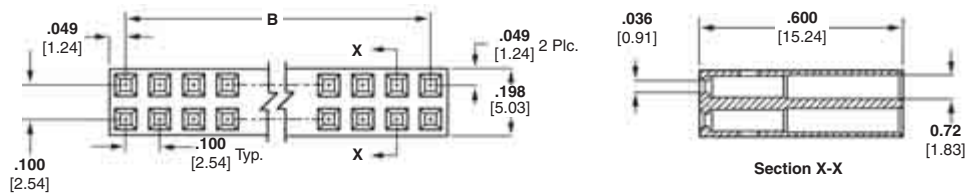

No. of Pos.	Dimensions		Housing Part No.
	A	B	
4	.198 [5.03]	.100 [2.54]	104482-1
6	.298 [7.57]	.200 [5.08]	104482-2
8	.398 [10.11]	.300 [7.62]	104482-3
10	.498 [12.65]	.400 [10.16]	104482-4
12	.598 [15.19]	.500 [12.70]	104482-5
14	.698 [17.73]	.600 [15.24]	104482-6
16	.798 [20.27]	.700 [17.78]	104482-7
18	.898 [22.81]	.800 [20.32]	104482-8
20	.998 [25.35]	.900 [22.86]	104482-9
22	1.098 [27.89]	1.000 [25.40]	1-104482-0
26	1.298 [32.97]	1.200 [30.48]	1-104482-1
28	1.398 [35.51]	1.300 [33.02]	1-104482-2
30	1.498 [38.05]	1.400 [35.56]	1-104482-3
32	1.598 [40.59]	1.500 [38.10]	1-104482-4
34	1.698 [43.13]	1.600 [40.64]	1-104482-5
36	1.798 [45.67]	1.700 [43.18]	1-104482-6
38	1.898 [48.21]	1.800 [45.72]	1-104482-7
40	1.998 [50.75]	1.900 [48.26]	1-104482-8
44	2.198 [55.83]	2.100 [53.34]	1-104482-9
52	2.598 [65.99]	2.500 [63.50]	2-104482-0

**Note:** All part numbers are RoHS compliant.

**Short Point Wire-Applied Housings, Double-Row, Polarized, .100 x .100 [2.54 x 2.54] Centerline**

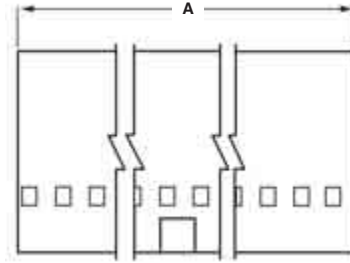

**Material**

Black thermoplastic, flame retardant, 94V-0 rated

**Related Product Data**

**Performance Characteristics** — page 221

**Contacts** — page 222

**Mateable Headers** — pages 104, 105, 135-138

**Technical Documents** — pages 276-278

**Product Specification** 108-1472

**Application Specification** 114-25038



No. of Pos.	Dimensions		Housing Part No.
	A	B	
8	.398 [10.11]	.300 [7.62]	104483-1
10	.498 [12.65]	.400 [10.16]	1-104483-1
12	.598 [15.19]	.500 [12.70]	1-104483-2
14	.698 [17.73]	.600 [15.24]	104483-9
18	.898 [22.81]	.800 [20.32]	104483-2
20	.998 [25.35]	.900 [22.86]	104483-3
26	1.298 [32.97]	1.200 [30.48]	104483-4
30	1.498 [38.05]	1.400 [35.56]	104483-5
38	1.898 [48.21]	1.800 [45.72]	104483-6
50	2.498 [63.45]	2.400 [60.96]	1-104483-3
52	2.598 [65.99]	2.500 [63.50]	1-104483-0
54	2.698 [68.53]	2.600 [66.04]	104483-7
64	3.198 [81.23]	3.100 [78.74]	104483-8

**Note:** Other sizes can be made available on request.

**Note:** All part numbers are RoHS compliant.



**MTE Interconnection System**

**Product Facts**

- Receptacle assemblies mate with .025 [0.64] sq. posts; mating post length is .200 [5.08] min., .250 [6.35] max.
- Proven AMPMODU receptacle contact design; dual cantilever beams, built-in anti-overstress, completely enclosed "box" design, standard or high-pressure
- Insulation displacement technology
- Two contact sizes for terminating 30-22 AWG [0.05-0.3 mm<sup>2</sup>] wire range; .054 [1.37] max. insulation diameter with an insulation wall thickness of .015 [0.38] max.
- Choice of gold duplex or tin plated contacts
- Interchangeable crimp snap-in pin and receptacle contacts available
- Housing sizes 2 through 25 positions, single-row .100 [2.54] centers
- Plain housings are end-to-end and/or back-to-back stackable for open pin field applications
- Optional header with "swaged tail" feature helps prevent movement prior to flow soldering
- Integral latch provides positive retention between header and receptacle housing
- Coupling shrouds permit ganging of smaller connectors with guide ribs to form larger single- or double-row latching connectors
- Mass terminating tooling provides lowest applied cost for most production needs
- SMT and SMT compatible, high-temp headers available
- Recognized under the Component Program of Underwriters Laboratories Inc., File No. E28476
- Certified by Canadian Standards Association, File No. LR7189

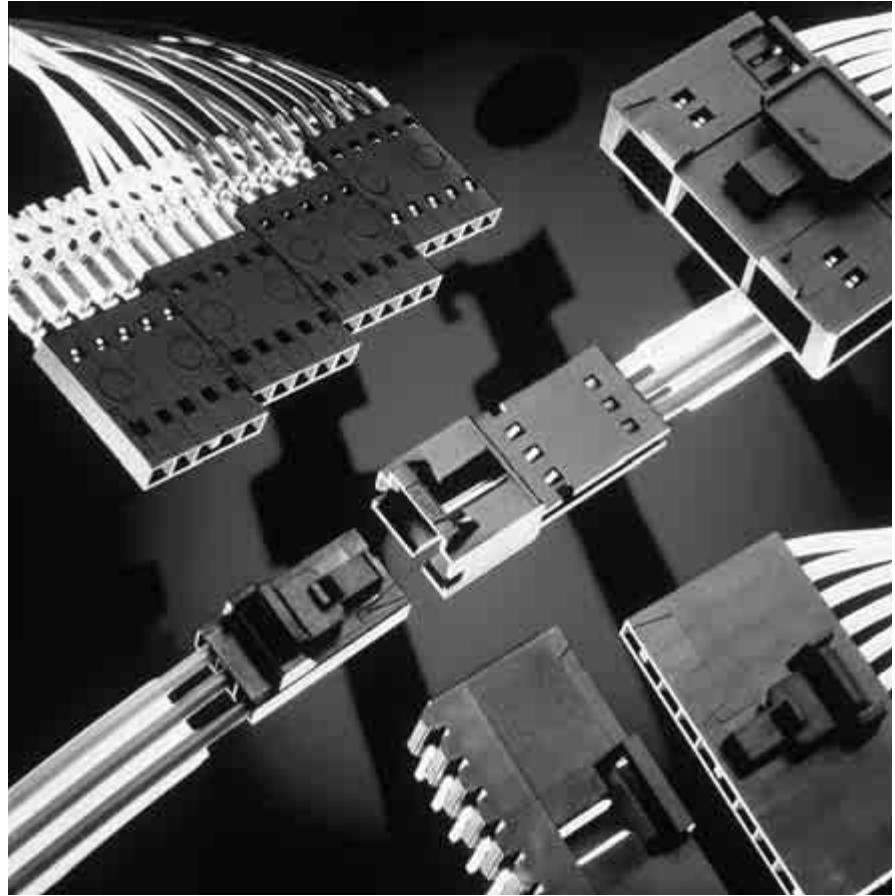

The AMPMODU MTE Interconnection System offers both wire-to-board and wire-to-wire connectors using .025 [0.64] sq. post technology.

The AMPMODU MTE Interconnection System consists of single-row housings with contacts preloaded on .100 [2.54] centers. Housings are furnished with contacts partially inserted, leaving the termination areas exposed. Final contact insertion can be accomplished automatically with Tyco Electronics application equipment, and manually when terminated with the Tyco Electronics pistol grip hand tool.

The heart of the system is the insulation displacement contact design, featured in both pin and receptacle contacts. The receptacle

contact, available in either standard or high-pressure, features dual cantilever beams in an enclosed "box." The post stop helps prevent a mating post from disturbing the wire termination and also limits the mating depth of a long post to protect a wrap-type termination at the base of the post. The forward contact stop helps prevent contact overinsertion prior to termination. All contacts are furnished on carrier strips which are interlocked for stability and positive location during termination.

Single-row housings are available in sizes 2 through 25 positions. Included are three styles of receptacle housings—plain, polarized/latching and ribbed and two styles of pin housings, shrouded with polarizing/latching feature and ribbed.

**Performance Specifications**

**Electrical Characteristics**

- Contact Current Rating** — 3 amperes for single contact in free air (Amperage could vary due to ambient temperature, wire size and duty cycles.)
- Contact Termination Resistance** — 15 milliohms (max.)
- Dielectric Withstanding Voltage** — At Sea Level—600 VAC, rms  
At 70,000 Ft. [21 336 m]—225 VAC, rms
- Insulation Resistance** — 5,000 megohms (min.)

**Environmental Characteristics**

- Operating Temperature** — -65°C to +105°C
- Vibration** — 15 G's (gold), 10 G's (tin)
- Physical Shock** — 50 G's
- Industrial Mixed Flow Gasing** — Class 1 (20 days) (gold)

**Product Specification**  
108-25034

**Application Specification**  
114-25026

**MTE Interconnection System (Continued)**

**Wire-to-Board**

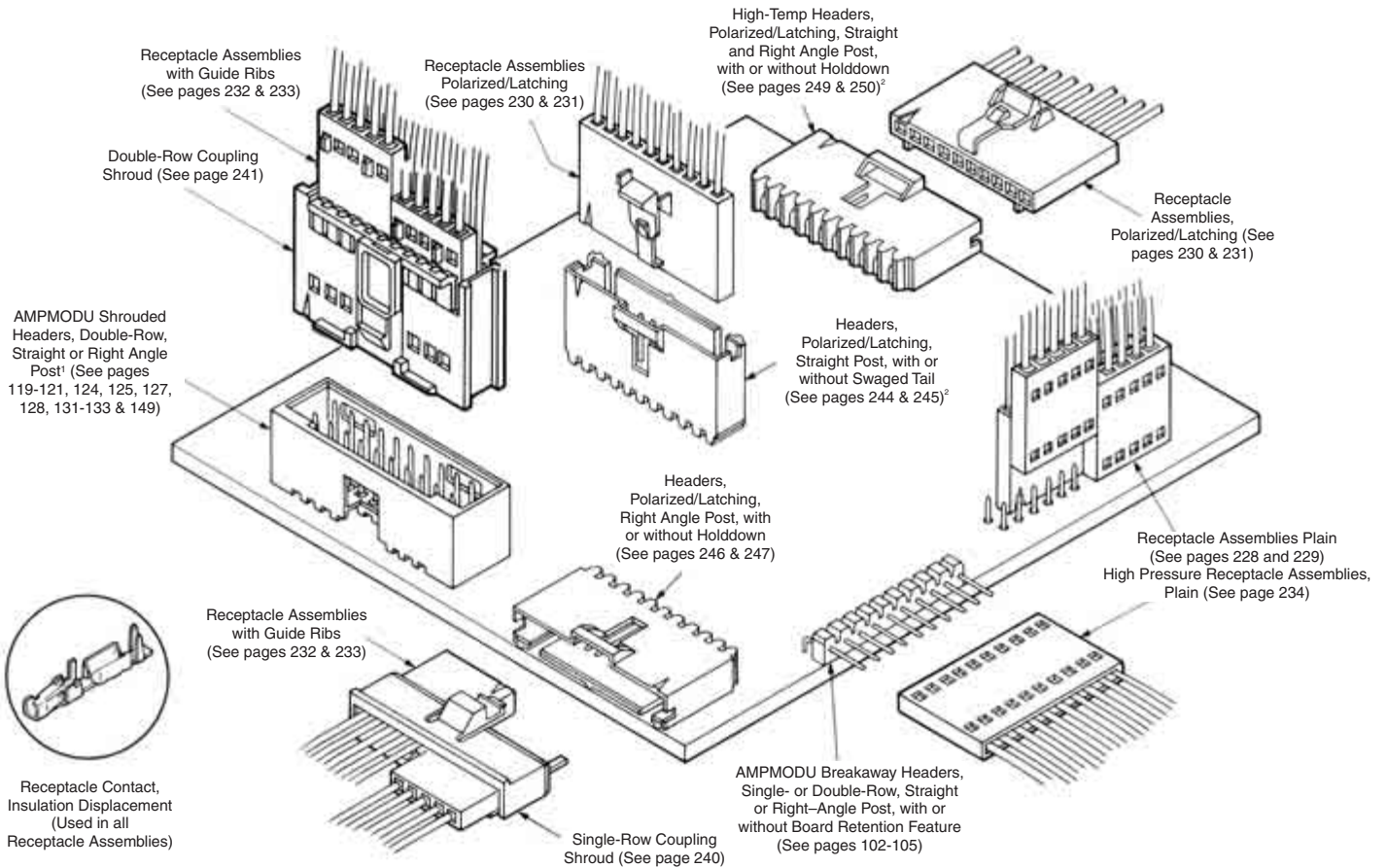

<sup>1</sup>Mating AMPMODU Double-Row Shrouded Header Assemblies must have .318 [8.08] mating post length and .150 [3.81] dimension from centerline of last post to inside of end shroud wall.

<sup>2</sup>Surface Mount Right-Angle and Vertical Headers are also available (see pages 251 and 252)

MTE Interconnection System

5

**MTE Interconnection System** (Continued)

**Wire-to-Wire**

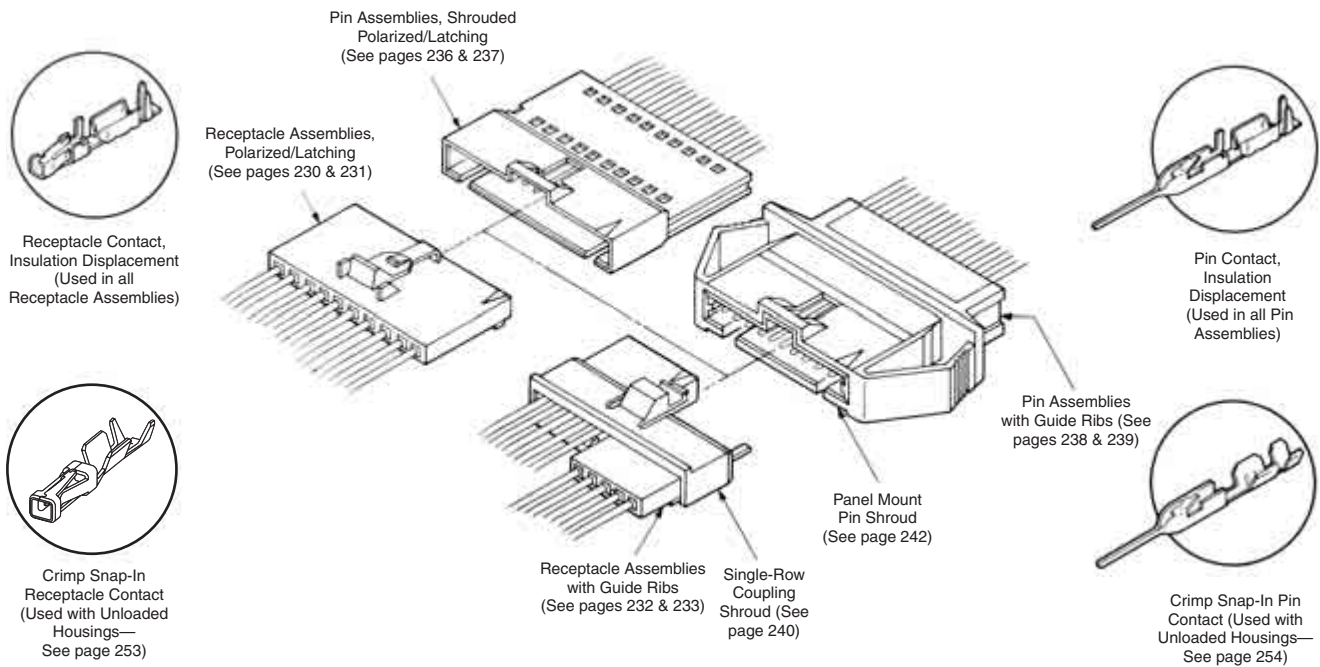

**Note:** For wire-to-wire applications shown above, all pin and receptacle assembly combinations are intermateable.

**MTE Receptacle Assemblies—Plain, Single-Row, .100 [2.54] Centerline**



Preassembled housings in strip form are available in positions 2 thru 12. For ease of handling, positions 2 thru 5 are recommended when using the Tyco Electronics Manual Pistol Grip Tool.

**Material and Finish**

**Housing** — Black thermoplastic, 94V-0 rated

**Contacts** — Phosphor Bronze, plated as follows:

**Plating A** — Duplex plated .000030 [0.00076] gold on contact area, .000050 [0.00127] min. tin in crimp area, with entire contact underplated .000050 [0.00127] nickel

**Plating B** — Duplex plated .000015 [0.00038] gold on contact area, .000050 [0.00127] min. tin in crimp area, with entire contact underplated .000050 [0.00127] nickel

**Plating C** — .000100 [0.00254] tin over .000050 [0.00127] nickel on entire contact

**Note:** Insulation displacement contacts accept an insulation diameter of .030 [0.76] min. to .054 [1.37] max. with an insulation wall thickness of .015 [0.38] max. Mating post length for preloaded housings is .200 [5.08] min., .250 [6.35] max.

**Related Product Data**

**Mateable AMPMODU Products Breakaway Headers** — pages 102-110 (with .230 mating length)

**Reeled Breakaway Headers** — pages 106, 107 (with .230 mating length)

**Machine Applied Bandolier Posts** — page 163

**Single-Row Shrouded Headers with .066 [1.68] End Dimension** — pages 115, 116

**Interchangeable Crimp Contacts (Short Point)** — page 253

**Application Tooling** — page 273

**Performance Specifications** — page 225

**Technical Documents** — pages 277, 278

**Product Specification**  
108-25034

**Application Specification**  
114-25026

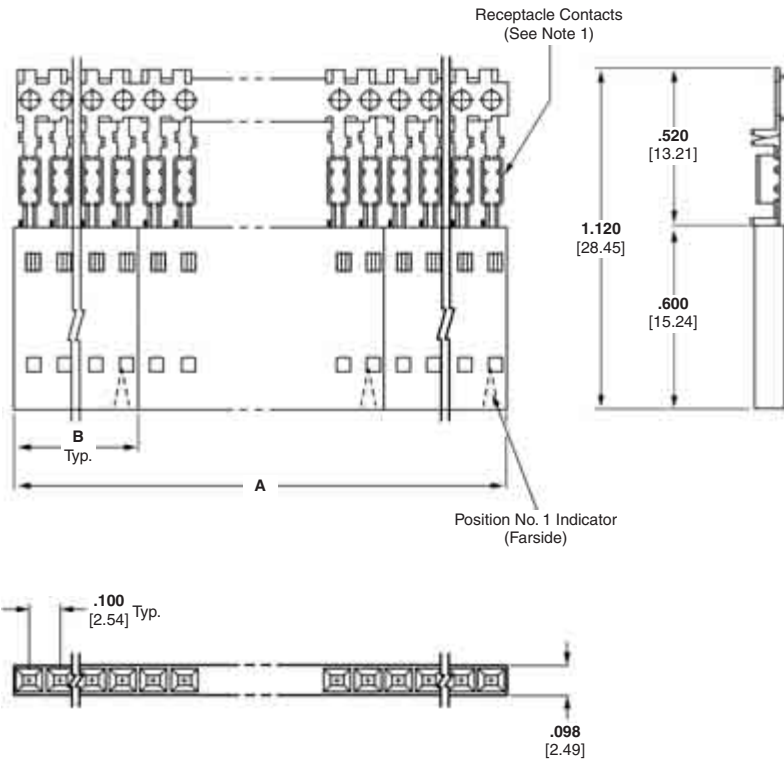

These receptacle assemblies with plain housings can be stacked end-to-end and/or side-to-side for single or double-row connections to an open pin field with a .100 [2.54] centerline grid.

## MTE Receptacle Assemblies—Strip Form Plain, Single-Row, .100 [2.54] Centerline (Continued)

No. of Pos.	Dimensions		Housing Quantities Per Strip Segment	Strip Form Receptacle Assembly 30-26 AWG [0.05-0.15mm <sup>2</sup> ] Wire			Strip Form Receptacle Assembly 26-22 AWG [0.12-0.3mm <sup>2</sup> ] Wire			Unloaded Housings
	A	B		Plating A	Plating B	Plating C	Plating A	Plating B	Plating C	
2	2.000 [50.80]	.198 [5.03]	10	5-103979-1	5-103978-1	5-103977-1	5-103976-1	5-103975-1	5-103974-1	103688-1
3	2.400 [60.96]	.298 [7.57]	8	5-103979-2	5-103978-2	5-103977-2	5-103976-2	5-103975-2	5-103974-2	103688-2
4	1.990 [50.55]	.398 [10.11]	5	5-103979-3	5-103978-3	5-103977-3	5-103976-3	5-103975-3	5-103974-3	103688-3
5	1.990 [50.55]	.498 [12.65]	4	5-103979-4	5-103978-4	5-103977-4	5-103976-4	5-103975-4	5-103974-4	103688-4
6	2.390 [60.71]	.598 [15.19]	4	5-103979-5	5-103978-5	5-103977-5	5-103976-5	5-103975-5	5-103974-5	103688-5
7	1.400 [35.56]	.698 [17.73]	2	5-103979-6	5-103978-6	5-103977-6	5-103976-6	5-103975-6	5-103974-6	103688-6
8	1.600 [40.64]	.798 [20.27]	2	5-103979-7	5-103978-7	5-103977-7	5-103976-7	5-103975-7	5-103974-7	103688-7
9	1.800 [45.72]	.898 [22.81]	2	5-103979-8	5-103978-8	5-103977-8	5-103976-8	5-103975-8	5-103974-8	103688-8
10	2.000 [50.80]	.998 [23.35]	2	5-103979-9	5-103978-9	5-103977-9	5-103976-9	5-103975-9	5-103974-9	103688-9
11	2.200 [55.88]	1.098 [27.89]	2	6-103979-0	6-103978-0	6-103977-0	6-103976-0	6-103975-0	6-103974-0	1-103688-0
12	2.400 [60.96]	1.198 [30.43]	2	6-103979-1	6-103978-1	6-103977-1	6-103976-1	6-103975-1	6-103974-1	1-103688-1

## MTE Receptacle Assemblies—Individual Form Plain, Single-Row, .100 [2.54] Centerline

No. of Pos.	Dimensions B	Individual Receptacle Assembly 30-26 AWG [0.05-0.15mm <sup>2</sup> ] Wire			Individual Receptacle Assembly 26-22 AWG [0.12-0.3mm <sup>2</sup> ] Wire			Unloaded Housings
		Plating A	Plating B	Plating C	Plating A	Plating B	Plating C	
13	1.298 [32.96]	6-103903-2	6-103684-2	6-103685-2	6-103902-2	6-103686-2	6-103687-2	1-103688-2
14	1.398 [35.51]	6-103903-3	6-103684-3	6-103685-3	6-103902-3	6-103686-3	6-103687-3	1-103688-3
15	1.498 [38.05]	6-103903-4	6-103684-4	6-103685-4	6-103902-4	6-103686-4	6-103687-4	1-103688-4
16	1.598 [40.59]	6-103903-5	6-103684-5	6-103685-5	6-103902-5	6-103686-5	6-103687-5	1-103688-5
17	1.698 [43.13]	6-103903-6	6-103684-6	6-103685-6	6-103902-6	6-103686-6	6-103687-6	1-103688-6
18	1.798 [45.67]	6-103903-7	6-103684-7	6-103685-7	6-103902-7	6-103686-7	6-103687-7	1-103688-7
19	1.898 [48.20]	6-103903-8	6-103684-8	6-103685-8	6-103902-8	6-103686-8	6-103687-8	1-103688-8
20	1.998 [50.75]	6-103903-9	6-103684-9	6-103685-9	6-103902-9	6-103686-9	6-103687-9	1-103688-9
21	2.098 [53.29]	7-103903-0	7-103684-0	7-103685-0	7-103902-0	7-103686-0	7-103687-0	2-103688-0
22	2.198 [55.83]	7-103903-1	7-103684-1	7-103685-1	7-103902-1	7-103686-1	7-103687-1	2-103688-1
23	2.298 [58.37]	7-103903-2	7-103684-2	7-103685-2	7-103902-2	7-103686-2	7-103687-2	2-103688-2
24	2.398 [60.91]	7-103903-3	7-103684-3	7-103685-3	7-103902-3	7-103686-3	7-103687-3	2-103688-3
25	2.498 [63.45]	7-103903-4	7-103684-4	7-103685-4	7-103902-4	7-103686-4	7-103687-4	2-103688-4

- Notes:** 1. Receptacle assemblies are furnished with strip contacts partially inserted into housing—contacts latched into “preload” windows. Contacts are fully inserted into housings automatically when terminated with Tyco Electronics application machines, or manually when terminated with Tyco Electronics pistol grip hand tool.  
 2. Use **Extraction/Lance Reset Tool No. 843477-1** to remove receptacle contacts.  
 3. Keying plugs are available, see page 253.

**Note:** All part numbers are RoHS compliant.



## MTE Receptacle Assemblies—Polarized/Latching, Single-Row, .100 [2.54] Centerline



Preassembled housings in strip form are available in positions 2 thru 12. For ease of handling, positions 2 thru 5 are recommended when using the Tyco Electronics Manual Pistol Grip Tool.

### Material and Finish

**Housing** — Black thermoplastic, 94V-0 rated

**Contacts** — Phosphor Bronze, plated as follows:

**Plating A** — Duplex plated .000030 [0.00076] gold on contact area, .000050 [0.00127] min. tin in crimp area, with entire contact underplated .000050 [0.00127] nickel

**Plating B** — Duplex plated .000015 [0.00038] gold on contact area, .000050 [0.00127] min. tin in crimp area, with entire contact underplated .000050 [0.00127] nickel

**Plating C** — .000100 [0.00254] tin over .000050 [0.00127] nickel on entire contact

**Note:** Insulation displacement contacts accept an insulation diameter of .030 [0.76] min. to .054 [1.37] max. with an insulation wall thickness of .015 [0.38] max. Mating post length for preloaded housings is .200 [5.08] min., .250 [6.35] max.

### Related Product Data

#### Mateable AMPMODU Products

**Pin Assemblies (Polarized/Latching)** — pages 236, 237

**Pin Assemblies with Guide Ribs (installed in Panel Mount Pin Shroud)** — pages 238, 239, 242

**Headers (Polarized/Latching)** — pages 244-252

**Interchangeable Crimp Contacts (Short Point)** — page 253

**Application Tooling** — page 273

**Performance Specifications** — page 225

**Technical Documents** — pages 277, 278

**Product Specification**  
108-25034

**Application Specification**  
114-25026

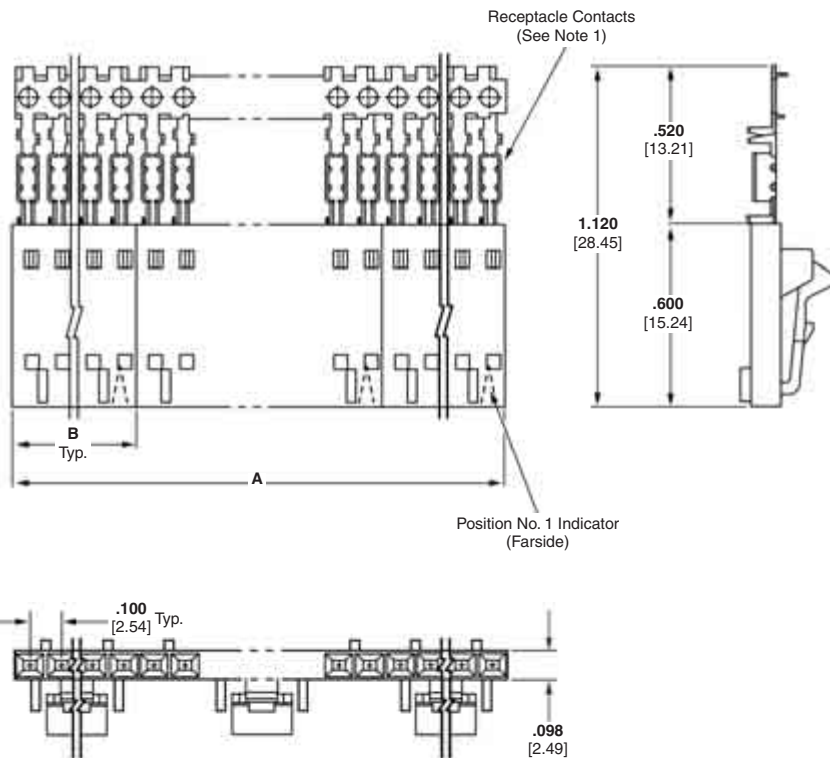



## MTE Receptacle Assemblies—Strip Form Polarized/Latching, Single-Row, .100 [2.54] Centerline (Continued)

No. of Pos.	Dimensions		Housing Quantities Per Strip Segment	Strip Form Receptacle Assembly 30-26 AWG [0.05-0.15mm <sup>2</sup> ] Wire			Strip Form Receptacle Assembly 26-22 AWG [0.12-0.3mm <sup>2</sup> ] Wire			Unloaded Housings
	A	B		Plating A	Plating B	Plating C	Plating A	Plating B	Plating C	
2	2.000 [50.80]	.198 [5.03]	10	5-103961-1	5-103960-1	5-103959-1	5-103958-1	5-103957-1	5-103956-1	104257-1
3	2.400 [60.96]	.298 [7.57]	8	5-103961-2	5-103960-2	5-103959-2	5-103958-2	5-103957-2	5-103956-2	104257-2
4	1.990 [50.55]	.398 [10.11]	5	5-103961-3	5-103960-3	5-103959-3	5-103958-3	5-103957-3	5-103956-3	104257-3
5	1.990 [50.55]	.498 [12.65]	4	5-103961-4	5-103960-4	5-103959-4	5-103958-4	5-103957-4	5-103956-4	104257-4
6	2.390 [60.71]	.598 [15.19]	4	5-103961-5	5-103960-5	5-103959-5	5-103958-5	5-103957-5	5-103956-5	104257-5
7	1.400 [35.56]	.698 [17.73]	2	5-103961-6	5-103960-6	5-103959-6	5-103958-6	5-103957-6	5-103956-6	104257-6
8	1.600 [40.64]	.798 [20.27]	2	5-103961-7	5-103960-7	5-103959-7	5-103958-7	5-103957-7	5-103956-7	104257-7
9	1.800 [45.72]	.898 [22.81]	2	5-103961-8	5-103960-8	5-103959-8	5-103958-8	5-103957-8	5-103956-8	104257-8
10	2.000 [50.80]	.998 [23.35]	2	5-103961-9	5-103960-9	5-103959-9	5-103958-9	5-103957-9	5-103956-9	104257-9
11	2.200 [55.88]	1.098 [27.89]	2	6-103961-0	6-103960-0	6-103959-0	6-103958-0	6-103957-0	6-103956-0	1-104257-0
12	2.400 [60.96]	1.198 [30.43]	2	6-103961-1	6-103960-1	6-103959-1	6-103958-1	6-103957-1	6-103956-1	1-104257-1

## MTE Receptacle Assemblies—Individual Form Polarized/Latching, Single-Row, .100 [2.54] Centerline

No. of Pos.	Dimensions B	Individual Receptacle Assembly 30-26 AWG [0.05-0.15mm <sup>2</sup> ] Wire			Individual Receptacle Assembly 26-22 AWG [0.12-0.3mm <sup>2</sup> ] Wire			Unloaded Housings
		Plating A	Plating B	Plating C	Plating A	Plating B	Plating C	
13	1.298 [32.96]	6-103897-2	6-103640-2	6-103641-2	6-103734-2	6-103644-2	6-103645-2	1-104257-2
14	1.398 [35.51]	6-103897-3	6-103640-3	6-103641-3	6-103734-3	6-103644-3	6-103645-3	1-104257-3
15	1.498 [38.05]	6-103897-4	6-103640-4	6-103641-4	6-103734-4	6-103644-4	6-103645-4	1-104257-4
16	1.598 [40.59]	6-103897-5	6-103640-5	6-103641-5	6-103734-5	6-103644-5	6-103645-5	1-104257-5
17	1.698 [43.13]	6-103897-6	6-103640-6	6-103641-6	6-103734-6	6-103644-6	6-103645-6	1-104257-6
18	1.798 [45.67]	6-103897-7	6-103640-7	6-103641-7	6-103734-7	6-103644-7	6-103645-7	1-104257-7
19	1.898 [48.20]	6-103897-8	6-103640-8	6-103641-8	6-103734-8	6-103644-8	6-103645-8	1-104257-8
20	1.998 [50.75]	6-103897-9	6-103640-9	6-103641-9	6-103734-9	6-103644-9	6-103645-9	1-104257-9
21	2.098 [53.29]	7-103897-0	7-103640-0	7-103641-0	7-103734-0	7-103644-0	7-103645-0	2-104257-0
22	2.198 [55.83]	7-103897-1	7-103640-1	7-103641-1	7-103734-1	7-103644-1	7-103645-1	2-104257-1
23	2.298 [58.37]	7-103897-2	7-103640-2	7-103641-2	7-103734-2	7-103644-2	7-103645-2	2-104257-2
24	2.398 [60.91]	7-103897-3	7-103640-3	7-103641-3	7-103734-3	7-103644-3	7-103645-3	2-104257-3
25	2.498 [63.45]	7-103897-4	7-103640-4	7-103641-4	7-103734-4	7-103644-4	7-103645-4	2-104257-4

- Notes:** 1. Receptacle assemblies are furnished with strip contacts partially inserted into housing—contacts latched into “preload” windows. Contacts are fully inserted into housings automatically when terminated with Tyco Electronics application machines, or manually when terminated with Tyco Electronics pistol grip hand tool.  
 2. Use **Extraction/Lance Reset Tool No. 843477-1** to remove receptacle contacts.  
 3. Keying plugs are available, see page 253.

**Note:** All part numbers are RoHS compliant.

**MTE Receptacle Assemblies—Guide Ribs,  
Single-Row, .100 [2.54] Centerline**



Preassembled housings in strip form are available in positions 2 thru 12. For ease of handling, positions 2 thru 5 are recommended when using the Tyco Electronics Manual Pistol Grip Tool.

**Material and Finish**

**Housing** — Black thermoplastic, 94V-0 rated

**Contacts** — Phosphor Bronze, plated as follows:

**Plating A** — Duplex plated .000030 [0.00076] gold on contact area, .000050 [0.00127] min. tin in crimp area, with entire contact underplated .000050 [0.00127] nickel

**Plating B** — Duplex plated .000015 [0.00038] gold on contact area, .000050 [0.00127] min. tin in crimp area, with entire contact underplated .000050 [0.00127] nickel

**Plating C** — .000100 [0.00254] tin over .000050 [0.00127] nickel on entire contact

**Note:** Insulation displacement contacts accept an insulation diameter of .030 [0.76] min. to .054 [1.37] max. with an insulation wall thickness of .015 [0.38] max. Mating post length for preloaded housings is .200 [5.08] min., .250 [6.35] max.

**Related Product Data**

**Coupling Shrouds used with —**  
**Single-Row** — page 240  
**Double-Row** — page 241

**Mateable AMPMODU Products (with Receptacle Assemblies Installed in Single-Row Coupling Shrouds) —**

**Pin Assemblies (Polarized/Latching)** — pages 236, 237

**Pin Assemblies with Guide Ribs (installed in Panel Mount Pin Shroud)** — pages 238, 239, 242

**Headers (Polarized/Latching)** — pages 244-252

**Mateable AMPMODU Products (with Receptacle Assemblies Installed in Double-Row Coupling Shrouds) —**

**Headers, Shrouded, Double-Row (.318 [8.08] mating post length, .150 [3.81] end dimension)** — pages 119-121, 124, 125, 128, 129, 131-133



MTE Receptacle Assemblies

5

**Interchangeable Crimp Contacts—**  
 (Short Point) — page 253

**Application Tooling** — page 273

**Performance Specifications** — page 225

**Technical Documents** — pages 277, 278

**Product Specification**  
 108-25034

**Application Specification**  
 114-25026

## MTE Receptacle Assemblies—Strip Form with Guide Ribs, Single-Row, .100 [2.54] Centerline (Continued)

No. of Pos.	Dimensions		Housing Quantities Per Strip Segment	Strip Form Receptacle Assembly 30-26 AWG [0.05-0.15mm <sup>2</sup> ] Wire			Strip Form Receptacle Assembly 26-22 AWG [0.12-0.3mm <sup>2</sup> ] Wire			Unloaded Housings
	A	B		Plating A	Plating B	Plating C	Plating A	Plating B	Plating C	
2	2.000 [50.80]	.198 [5.03]	10	5-103973-1	5-103972-1	5-103971-1	5-103970-1	5-103969-1	5-103968-1	103648-1
3	2.400 [60.96]	.298 [7.57]	8	5-103973-2	5-103972-2	5-103971-2	5-103970-2	5-103969-2	5-103968-2	103648-2
4	1.990 [50.55]	.398 [10.11]	5	5-103973-3	5-103972-3	5-103971-3	5-103970-3	5-103969-3	5-103968-3	103648-3
5	1.990 [50.55]	.498 [12.65]	4	5-103973-4	5-103972-4	5-103971-4	5-103970-4	5-103969-4	5-103968-4	103648-4
6	2.390 [60.71]	.598 [15.19]	4	5-103973-5	5-103972-5	5-103971-5	5-103970-5	5-103969-5	5-103968-5	103648-5
7	1.400 [35.56]	.698 [17.73]	2	5-103973-6	5-103972-6	5-103971-6	5-103970-6	5-103969-6	5-103968-6	103648-6
8	1.600 [40.64]	.798 [20.27]	2	5-103973-7	5-103972-7	5-103971-7	5-103970-7	5-103969-7	5-103968-7	103648-7
9	1.800 [45.72]	.898 [22.81]	2	5-103973-8	5-103972-8	5-103971-8	5-103970-8	5-103969-8	5-103968-8	103648-8
10	2.000 [50.80]	.998 [23.35]	2	5-103973-9	5-103972-9	5-103971-9	5-103970-9	5-103969-9	5-103968-9	103648-9
11	2.200 [55.88]	1.098 [27.89]	2	6-103973-0	6-103972-0	6-103971-0	6-103970-0	6-103969-0	6-103968-0	1-103648-0
12	2.400 [60.96]	1.198 [30.43]	2	6-103973-1	6-103972-1	6-103971-1	6-103970-1	6-103969-1	6-103968-1	1-103648-1

## MTE Receptacle Assemblies—Individual Form with Guide Ribs, Single-Row, .100 [2.54] Centerline

No. of Pos.	Dimensions B	Individual Receptacle Assembly 30-26 AWG [0.05-0.15mm <sup>2</sup> ] Wire			Individual Receptacle Assembly 26-22 AWG [0.12-0.3mm <sup>2</sup> ] Wire			Unloaded Housings
		Plating A	Plating B	Plating C	Plating A	Plating B	Plating C	
13	1.298 [32.96]	6-103901-2	6-103649-2	6-103650-2	6-103900-2	6-103651-2	6-103652-2	1-103648-2
14	1.398 [35.51]	6-103901-3	6-103649-3	6-103650-3	6-103900-3	6-103651-3	6-103652-3	1-103648-3
15	1.498 [38.05]	6-103901-4	6-103649-4	6-103650-4	6-103900-4	6-103651-4	6-103652-4	1-103648-4
16	1.598 [40.59]	6-103901-5	6-103649-5	6-103650-5	6-103900-5	6-103651-5	6-103652-5	1-103648-5
17	1.698 [43.13]	6-103901-6	6-103649-6	6-103650-6	6-103900-6	6-103651-6	6-103652-6	1-103648-6
18	1.798 [45.67]	6-103901-7	6-103649-7	6-103650-7	6-103900-7	6-103651-7	6-103652-7	1-103648-7
19	1.898 [48.20]	6-103901-8	6-103649-8	6-103650-8	6-103900-8	6-103651-8	6-103652-8	1-103648-8
20	1.998 [50.75]	6-103901-9	6-103649-9	6-103650-9	6-103900-9	6-103651-9	6-103652-9	1-103648-9
21	2.098 [53.29]	7-103901-0	7-103649-0	7-103650-0	7-103900-0	7-103651-0	7-103652-0	2-103648-0
22	2.198 [55.83]	7-103901-1	7-103649-1	7-103650-1	7-103900-1	7-103651-1	7-103652-1	2-103648-1
23	2.298 [58.37]	7-103901-2	7-103649-2	7-103650-2	7-103900-2	7-103651-2	7-103652-2	2-103648-2
24	2.398 [60.91]	7-103901-3	7-103649-3	7-103650-3	7-103900-3	7-103651-3	7-103652-3	2-103648-3
25	2.498 [63.45]	7-103901-4	7-103649-4	7-103650-4	7-103900-4	7-103651-4	7-103652-4	2-103648-4

- Notes:**
1. Receptacle assemblies are furnished with strip contacts partially inserted into housing—contacts latched into “preload” windows. Contacts are fully inserted into housings automatically when terminated with Tyco Electronics application machines, or manually when terminated with Tyco Electronics pistol grip hand tool.
  2. Use **Extraction/Lance Reset Tool No. 843477-1** to remove receptacle contacts.
  3. Keying plugs are available, see page 253.

**Note:** All part numbers are RoHS compliant.

## MTE High Pressure Receptacle Assemblies—Plain, Single-Row, .100 [2.54] Centerline



Preassembled housings in strip form are available in positions 2 thru 12. For ease of handling, positions 2 thru 5 are recommended when using the Tyco Electronics Manual Pistol Grip Tool.

### Material and Finish

**Housing** — Black thermoplastic, 94V-0 rated

**Contacts** — Phosphor Bronze, duplex plated .000030 [0.00076] gold on contact area, .000050 [0.00127] min. tin in crimp area, with entire contact underplated .000050 [0.00127] nickel

**Note:** Insulation displacement contacts accept an insulation diameter of .030 [0.76] min. to .054 [1.37] max. with an insulation wall thickness of .015 [0.38] max. Mating post length for preloaded housings is .200 [5.08] min., .250 [6.35] max.



### Related Product Data

#### Mateable AMPMODU Products

**Breakaway Headers** — pages 102-110, (with .230 mating length)

**Reeled Breakaway Headers** — pages 106, 107 (with .230 mating length)

**Machine Applied Bandolier Posts** — page 163

**Application Tooling** — page 273

**Performance Specifications** — page 225

**Technical Documents** — pages 277, 278)

**Product Specification**  
108-25034

**Application Specification**  
114-25026

No. of Pos.	Dimensions		Housings Quantities Per Strip Segment	Strip Form Receptacle Assembly	Strip Form Receptacle Assembly
	A	B		30-26 AWG [.05-.15mm <sup>2</sup> ] Wire	26-22 AWG [.12-.30mm <sup>2</sup> ] Wire
2	1.980 [50.29]	.198 [5.03]	10	5-104438-1	5-104439-1
3	1.490 [37.85]	.298 [7.57]	5	5-104438-2	5-104439-2
4	1.990 [50.55]	.398 [10.11]	5	5-104438-3	5-104439-3
5	1.990 [50.55]	.498 [12.65]	4	5-104438-4	5-104439-4
6	2.390 [60.71]	.598 [15.19]	4	5-104438-5	5-104439-5
7	1.400 [35.56]	.698 [17.73]	2	5-104438-6	5-104439-6
8	1.600 [40.64]	.798 [20.27]	2	5-104438-7	5-104439-7
9	1.800 [45.72]	.898 [22.81]	2	5-104438-8	5-104439-8
10	2.000 [50.80]	.998 [23.35]	2	5-104438-9	5-104439-9
11	2.200 [55.88]	1.098 [27.89]	2	6-104438-0	6-104439-0
12	2.400 [60.96]	1.198 [30.43]	2	6-104438-1	6-104439-1

- Notes:**
1. Receptacle assemblies are furnished with strip contacts partially inserted into housing—contacts latched into “preload” windows. Contacts are fully inserted into housings automatically when terminated with Tyco Electronics application machines, or manually when terminated with Tyco Electronics pistol grip hand tool.
  2. High pressure receptacle contacts can be made available in other housing styles and position sizes. Contact your Tyco Electronics sales representative.

**Note:** All part numbers are RoHS compliant.

**MTE High Pressure Receptacle Assemblies – Guide Ribs**



Preassembled housings in strip form are available in positions 2 thru 12. For ease of handling, positions 2 thru 5 are recommended when using the Tyco Electronics Manual Pistol Grip Tool.

**Material and Finish**

**Housing** — Thermoplastic, black, 94V-0 rated

**Contacts** — Phosphor Bronze, duplex plated .000030 [0.00076] gold on contact area, .000050 [0.00127] min. tin on crimp area, with entire contact underplated .000050 [0.00127] nickel.

**Related Product Data**

**Coupling Shrouds used with —**  
**Single-Row** — page 240  
**Double-Row** — page 241

**Mateable AMPMODU Products (with Receptacle Assemblies Installed in Single-Row Coupling Shrouds) —**

**Pin Assemblies (Polarized/Latching)** — pages 236, 237

**Pin Assemblies with Guide Ribs (installed in Panel Mount Pin Shroud)** — pages 238, 239, 242

**Headers (Polarized/Latching)** — pages 244-252

**Mateable AMPMODU Products (with Receptacle Assemblies Installed in Double-Row Coupling Shrouds) —**

**Headers, Shrouded, Double-Row (.318 [8.08] mating post length, .150 [3.81] end dimension)** — pages 119-121, 124, 125, 128, 129, 131-133

**Application Tooling** — page 273

**Performance Specifications** — page 225

**Technical Documents** — pages 277, 278

**Product Specification**  
 108-25034

**Application Specification**  
 114-25026

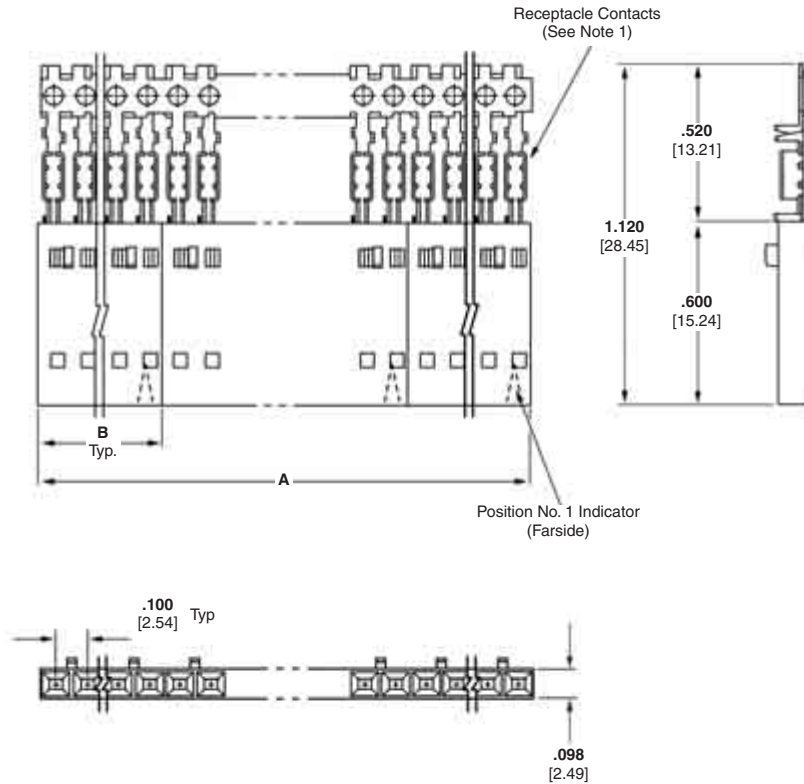

No. of Pos.	Dimensions		Housings Quantities Per Strip Segment	Strip Form Receptacle Assembly 30-26 AWG [.05-.15mm <sup>2</sup> ] Wire	Strip Form Receptacle Assembly 26-22 AWG [.12-.30mm <sup>2</sup> ] Wire
	A	B			
2	1.980 [50.29]	.198 [5.03]	10	5-147396-1	5-147030-3
3	1.490 [37.85]	.298 [7.57]	5	5-147396-2	5-147030-4
4	1.990 [50.55]	.398 [10.11]	5	5-147396-3	5-147030-1
5	1.990 [50.55]	.498 [12.65]	4	5-147396-4	5-147030-2
6	2.390 [60.71]	.598 [15.19]	4	5-147396-5	5-147030-5
7	1.400 [35.56]	.698 [17.73]	2	5-147396-6	5-147030-6
8	1.600 [40.64]	.798 [20.27]	2	5-147396-7	5-147030-7
9	1.800 [45.72]	.898 [22.81]	2	5-147396-8	5-147030-8
10	2.000 [50.80]	.998 [23.35]	2	5-147396-9	5-147030-9
11	2.200 [55.88]	1.098 [27.89]	2	6-147396-0	6-147030-0
12	2.400 [60.96]	1.198 [30.43]	2	6-147396-1	6-147030-1

**Note:** All part numbers are RoHS compliant.

**MTE Pin Assemblies, Shrouded—Polarized/Latching,  
Single-Row, .100 [2.54] Centerline**



Preassembled housings in strip form are available in positions 2 thru 12. For ease of handling, positions 2 thru 5 are recommended when using the Tyco Electronics Manual Pistol Grip Tool.

**Material and Finish**

**Housing** — Black thermoplastic, 94V-0 rated

**Contacts** — Phosphor Bronze, plated as follows:

**Plating A** — Duplex plated .000030 [0.00076] gold on contact area, .000050 [0.00127] min. tin in crimp area, with entire contact underplated .000050 [0.00127] nickel

**Plating B** — Duplex plated .000015 [0.00038] gold on contact area, .000050 [0.00127] min. tin in crimp area, with entire contact underplated .000050 [0.00127] nickel

**Plating C** — .000100 [0.00254] tin over .000050 [0.00127] nickel on entire contact

**Note:** Insulation displacement contacts accept an insulation diameter of .030 [0.76] min. to .054 [1.37] max. with an insulation wall thickness of .015 [0.38] max.

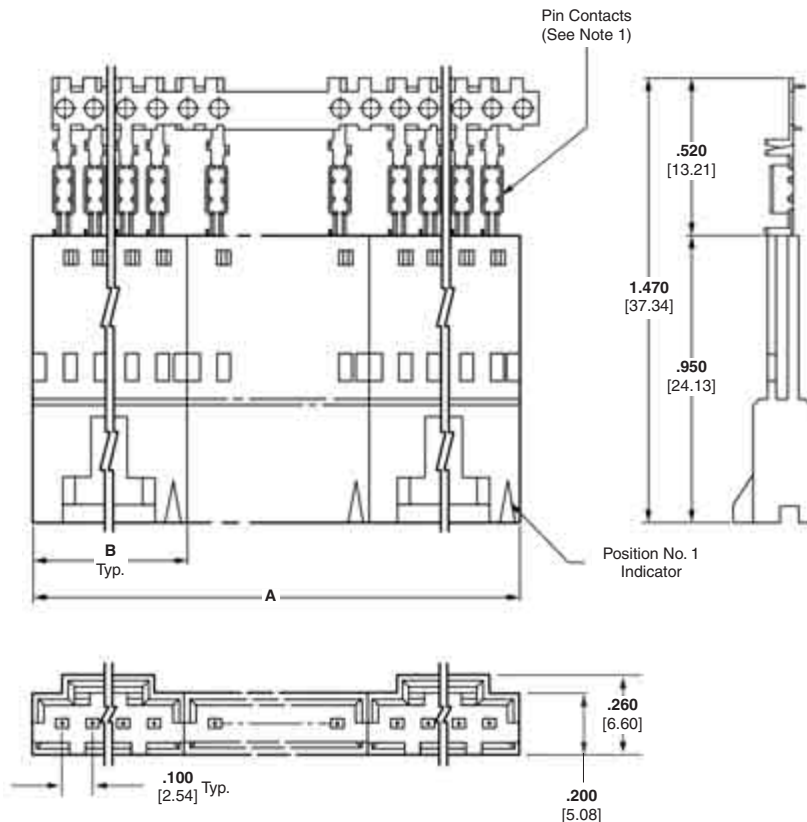

**Related Product Data**

**Mateable AMPMODU Products** —

**Receptacle Assemblies (Polarized/Latching)** — pages 230, 231

**Receptacle Assemblies with Guide Ribs (installed in Single-Row Coupling Shroud)** — pages 232, 233, 235, 240

**Interchangeable Crimp Contacts** — page 254

**Application Tooling** — page 273

**Performance Specifications** — page 225

**Technical Documents** — pages 277, 278

**Product Specification**  
108-25034

**Application Specification**  
114-25026



### MTE Pin Assemblies, Shrouded—Strip Form Polarized/Latching, Single-Row, .100 [2.54] Centerline (Continued)

No. of Pos.	Dimensions		Housing Quantities Per Strip Segment	Strip Form Pin Assembly 30-26 AWG [0.05-0.15mm <sup>2</sup> ] Wire			Strip Form Pin Assembly 26-22 AWG [0.12-0.3mm <sup>2</sup> ] Wire			Unloaded Housings
	A	B		Plating A	Plating B	Plating C	Plating A	Plating B	Plating C	
2	2.360 [59.94]	.295 [7.49]	8	5-103949-1	5-103948-1	5-103947-1	5-103946-1	5-103945-1	5-103944-1	103653-1
3	1.980 [50.29]	.395 [10.03]	5	5-103949-2	5-103948-2	5-103947-2	5-103946-2	5-103945-2	5-103944-2	103653-2
4	1.980 [50.29]	.495 [12.57]	4	5-103949-3	5-103948-3	5-103947-3	5-103946-3	5-103945-3	5-103944-3	103653-3
5	2.380 [60.45]	.595 [15.11]	4	5-103949-4	5-103948-4	5-103947-4	5-103946-4	5-103945-4	5-103944-4	103653-4
6	1.390 [35.31]	.695 [17.65]	2	5-103949-5	5-103948-5	5-103947-5	5-103946-5	5-103945-5	5-103944-5	103653-5
7	2.390 [60.71]	.795 [20.19]	3	5-103949-6	5-103948-6	5-103947-6	5-103946-6	5-103945-6	5-103944-6	103653-6
8	1.790 [45.47]	.895 [22.73]	2	5-103949-7	5-103948-7	5-103947-7	5-103946-7	5-103945-7	5-103944-7	103653-7
9	1.990 [50.57]	.995 [25.27]	2	5-103949-8	5-103948-8	5-103947-8	5-103946-8	5-103945-8	5-103944-8	103653-8
10	2.190 [55.63]	1.095 [27.81]	2	5-103949-9	5-103948-9	5-103947-9	5-103946-9	5-103945-9	5-103944-9	103653-9
11	2.390 [60.71]	1.195 [30.35]	2	6-103949-0	6-103948-0	6-103947-0	6-103946-0	6-103945-0	6-103944-0	1-103653-0
12	2.590 [65.79]	1.295 [32.89]	2	6-103949-1	6-103948-1	6-103947-1	6-103946-1	6-103945-1	6-103944-1	1-103653-1

### MTE Pin Assemblies, Shrouded—Individual Form Polarized/Latching, Single-Row, .100 [2.54] Centerline

No. of Pos.	Dimensions B	Individual Pin Assembly 30-26 AWG [0.05-0.15mm <sup>2</sup> ] Wire			Individual Pin Assembly 26-22 AWG [0.12-0.3mm <sup>2</sup> ] Wire			Unloaded Housings
		Plating A	Plating B	Plating C	Plating A	Plating B	Plating C	
13	1.395 [35.43]	6-103894-2	6-103658-2	6-103659-2	6-103893-2	6-103660-2	6-103661-2	1-103653-2
14	1.495 [37.97]	6-103894-3	6-103658-3	6-103659-3	6-103893-3	6-103660-3	6-103661-3	1-103653-3
15	1.595 [40.51]	6-103894-4	6-103658-4	6-103659-4	6-103893-4	6-103660-4	6-103661-4	1-103653-4
16	1.695 [43.05]	6-103894-5	6-103658-5	6-103659-5	6-103893-5	6-103660-5	6-103661-5	1-103653-5
17	1.795 [45.59]	6-103894-6	6-103658-6	6-103659-6	6-103893-6	6-103660-6	6-103661-6	1-103653-6
18	1.895 [48.13]	6-103894-7	6-103658-7	6-103659-7	6-103893-7	6-103660-7	6-103661-7	1-103653-7
19	1.995 [50.67]	6-103894-8	6-103658-8	6-103659-8	6-103893-8	6-103660-8	6-103661-8	1-103653-8
20	2.095 [53.21]	6-103894-9	6-103658-9	6-103659-9	6-103893-9	6-103660-9	6-103661-9	1-103653-9
21	2.195 [55.75]	7-103894-0	7-103658-0	7-103659-0	7-103893-0	7-103660-0	7-103661-0	2-103653-0
22	2.295 [58.29]	7-103894-1	7-103658-1	7-103659-1	7-103893-1	7-103660-1	7-103661-1	2-103653-1
23	2.395 [60.83]	7-103894-2	7-103658-2	7-103659-2	7-103893-2	7-103660-2	7-103661-2	2-103653-2
24	2.495 [63.37]	7-103894-3	7-103658-3	7-103659-3	7-103893-3	7-103660-3	7-103661-3	2-103653-3
25	2.595 [65.91]	7-103894-4	7-103658-4	7-103659-4	7-103893-4	7-103660-4	7-103661-4	2-103653-4

- Notes:** 1. Pin assemblies are furnished with strip contacts partially inserted into housing—contacts latched into “preload” windows. Contacts are fully inserted into housings automatically when terminated with Tyco Electronics application machines, or manually when terminated with Tyco Electronics pistol grip hand tool.  
2. Use **Extraction/Lance Reset Tool No. 843477-1** to remove pin contacts.

**Note:** All part numbers are RoHS compliant.

**MTE Pin Assemblies—Guide Ribs,  
Single-Row, .100 [2.54] Centerline**



Preassembled housings in strip form are available in positions 2 thru 12. For ease of handling, positions 2 thru 5 are recommended when using the Tyco Electronics Manual Pistol Grip Tool.

**Material and Finish**

**Housing** — Black thermoplastic, 94V-0 rated

**Contacts** — Phosphor Bronze, plated as follows:

**Plating A** — Duplex plated .000030 [0.00076] gold on contact area, .000050 [0.00127] min. tin in crimp area, with entire contact underplated .000050 [0.00127] nickel

**Plating B** — Duplex plated .000015 [0.00038] gold on contact area, .000050 [0.00127] min. tin in crimp area, with entire contact underplated .000050 [0.00127] nickel

**Plating C** — .000100 [0.00254] tin over .000050 [0.00127] nickel on entire contact

**Note:** Insulation displacement contacts accept an insulation diameter of .030 [0.76] min. to .054 [1.37] max. with an insulation wall thickness of .015 [0.38] max.

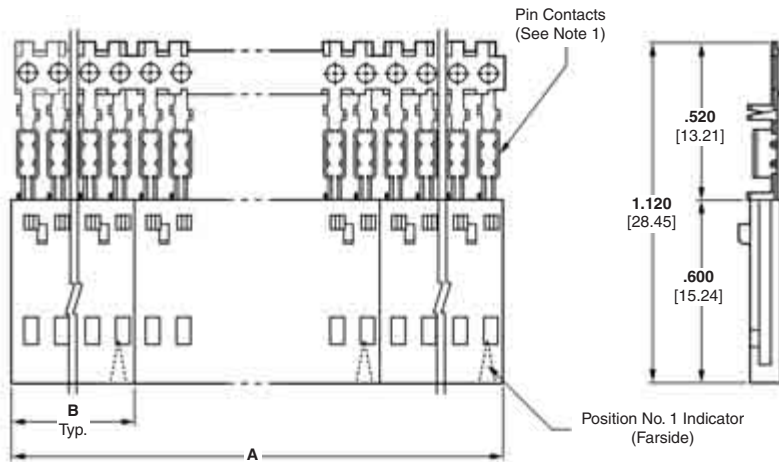

**Related Product Data**

**Mateable AMPMODU MTE Products (with Pin Assembly Installed in Panel Mount Pin Shroud)** — pages 242, 243

**Receptacle Assemblies (Polarized/Latching)** — pages 230, 231

**Receptacle Assemblies with Guide Ribs (installed in Single Row Coupling Shroud)** — pages 232, 233, 235, 240

**Interchangeable Crimp Contacts** — page 254

**Application Tooling** — page 273

**Performance Specifications** — page 225

**Technical Documents** — pages 277, 278

**Product Specification**  
108-25034

**Application Specification**  
114-25026

### MTE Pin Assemblies—Strip Form with Guide Ribs, Single-Row, .100 [2.54] Centerline (Continued)

No. of Pos.	Dimensions		Housing Quantities Per Strip Segment	Strip Form Pin Assembly 30-26 AWG [0.05-0.15mm <sup>2</sup> ] Wire			Strip Form Pin Assembly 26-22 AWG [0.12-0.3mm <sup>2</sup> ] Wire			Unloaded Housings
	A	B		Plating A	Plating B	Plating C	Plating A	Plating B	Plating C	
2	1.980 [50.29]	0.198 [5.03]	10	5-103955-1	5-103954-1	5-103953-1	5-103952-1	5-103951-1	5-103950-1	104503-1
3	1.490 [37.85]	0.298 [7.57]	5	5-103955-2	5-103954-2	5-103953-2	5-103952-2	5-103951-2	5-103950-2	104503-2
4	1.990 [50.55]	0.398 [10.11]	5	5-103955-3	5-103954-3	5-103953-3	5-103952-3	5-103951-3	5-103950-3	104503-3
5	1.990 [50.55]	0.498 [12.65]	4	5-103955-4	5-103954-4	5-103953-4	5-103952-4	5-103951-4	5-103950-4	104503-4
6	2.390 [60.71]	0.598 [15.19]	4	5-103955-5	5-103954-5	5-103953-5	5-103952-5	5-103951-5	5-103950-5	104503-5
7	1.400 [35.56]	0.698 [17.73]	2	5-103955-6	5-103954-6	5-103953-6	5-103952-6	5-103951-6	5-103950-6	104503-6
8	1.600 [40.64]	0.798 [20.27]	2	5-103955-7	5-103954-7	5-103953-7	5-103952-7	5-103951-7	5-103950-7	104503-7
9	1.800 [45.72]	0.898 [22.81]	2	5-103955-8	5-103954-8	5-103953-8	5-103952-8	5-103951-8	5-103950-8	104503-8
10	2.000 [50.80]	0.998 [25.35]	2	5-103955-9	5-103954-9	5-103953-9	5-103952-9	5-103951-9	5-103950-9	104503-9
11	2.200 [55.88]	1.098 [27.89]	2	6-103955-0	6-103954-0	6-103953-0	6-103952-0	6-103951-0	6-103950-0	1-104503-0
12	2.400 [60.96]	1.198 [30.43]	2	6-103955-1	6-103954-1	6-103953-1	6-103952-1	6-103951-1	6-103950-1	1-104503-1

### MTE Pin Assemblies—Individual Form with Guide Ribs, Single-Row, .100 [2.54] Centerline

No. of Pos.	Dimensions B	Individual Pin Assembly 30-26 AWG [0.05-0.15mm <sup>2</sup> ] Wire			Individual Pin Assembly 26-22 AWG [0.12-0.3mm <sup>2</sup> ] Wire			Unloaded Housings
		Plating A	Plating B	Plating C	Plating A	Plating B	Plating C	
13	1.398 [35.51]	6-103896-2	6-103657-2	6-103656-2	6-103895-2	6-103655-2	6-103654-2	1-104503-2
14	1.498 [38.05]	6-103896-3	6-103657-3	6-103656-3	6-103895-3	6-103655-3	6-103654-3	1-104503-3
15	1.598 [40.59]	6-103896-4	6-103657-4	6-103656-4	6-103895-4	6-103655-4	6-103654-4	1-104503-4
16	1.698 [43.13]	6-103896-5	6-103657-5	6-103656-5	6-103895-5	6-103655-5	6-103654-5	1-104503-5
17	1.798 [45.67]	6-103896-6	6-103657-6	6-103656-6	6-103895-6	6-103655-6	6-103654-6	1-104503-6
18	1.898 [48.20]	6-103896-7	6-103657-7	6-103656-7	6-103895-7	6-103655-7	6-103654-7	1-104503-7
19	1.998 [50.75]	6-103896-8	6-103657-8	6-103656-8	6-103895-8	6-103655-8	6-103654-8	1-104503-8
20	2.098 [53.29]	6-103896-9	6-103657-9	6-103656-9	6-103895-9	6-103655-9	6-103654-9	1-104503-9
21	2.198 [55.83]	7-103896-0	7-103657-0	7-103656-0	7-103895-0	7-103655-0	7-103654-0	2-104503-0
22	2.298 [58.37]	7-103896-1	7-103657-1	7-103656-1	7-103895-1	7-103655-1	7-103654-1	2-104503-1
23	2.398 [60.91]	7-103896-2	7-103657-2	7-103656-2	7-103895-2	7-103655-2	7-103654-2	2-104503-2
24	2.498 [63.45]	7-103896-3	7-103657-3	7-103656-3	7-103895-3	7-103655-3	7-103654-3	2-104503-3
25	2.598 [65.99]	7-103896-4	7-103657-4	7-103656-4	7-103895-4	7-103655-4	7-103654-4	2-104503-4

**Notes:** 1. Pin assemblies are furnished with strip contacts partially inserted into housing—contacts latched into “preload” windows. Contacts are fully inserted into housings automatically when terminated with Tyco Electronics application machines, or manually when terminated with Tyco Electronics pistol grip hand tool.

2. Use **Extraction/Lance Reset Tool No. 843477-1** to remove pin contacts.

**Note:** All part numbers are RoHS compliant.

## Coupling Shrouds for MTE Receptacle Assemblies with Guide Ribs

### Single-Row

#### Material

Black thermoplastic, 94V-0 rated

**Technical Documents** —  
pages 277, 278

**Product Specification**  
108-25034

**Application Specification**  
114-25026

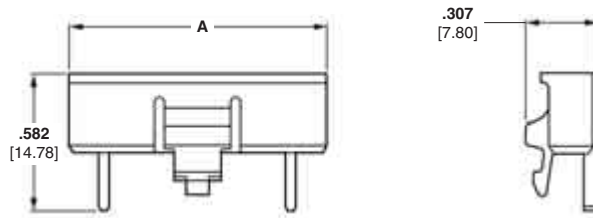

No. of Pos.	Dimension A	Single-Row Coupling Shroud
4	.485 [12.32]	103680-1
5	.585 [14.86]	103680-2
6	.685 [17.40]	103680-3
7	.785 [19.94]	103680-4
8	.885 [22.48]	103680-5
9	.985 [25.02]	103680-6
10	1.085 [27.56]	103680-7
11	1.185 [30.10]	103680-8
12	1.285 [32.64]	103680-9
13	1.385 [35.18]	1-103680-0
14	1.485 [37.72]	1-103680-1

No. of Pos.	Dimension A	Single-Row Coupling Shroud
15	1.585 [40.26]	1-103680-2
16	1.685 [42.80]	1-103680-3
17	1.785 [45.34]	1-103680-4
18	1.885 [47.88]	1-103680-5
19	1.985 [50.42]	1-103680-6
20	2.085 [52.96]	1-103680-7
21	2.185 [55.50]	1-103680-8
22	2.285 [58.04]	1-103680-9
23	2.385 [60.58]	2-103680-0
24	2.485 [63.12]	2-103680-1
25	2.585 [65.66]	2-103680-2



**Typical Application of Single-Row Coupling Shroud and Mating AMPMODU MTE Products**

**Note:** All part numbers are RoHS compliant.

**Coupling Shrouds for MTE Receptacle Assemblies with Guide Ribs** (Continued)

**Double-Row**

**Material**

Black thermoplastic, 94V-0 rated

**Technical Documents** —  
pages 277, 278

**Product Specification**  
108-25034

**Application Specification**  
114-25026

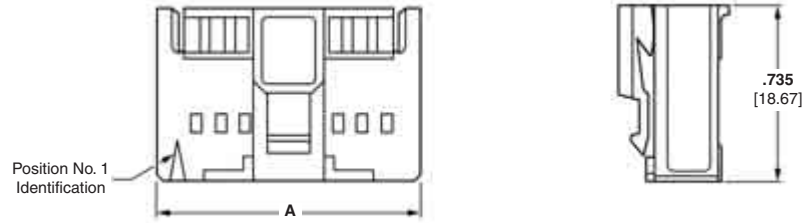

No. of Pos.	Dimension A	Double-Row Coupling Shroud
8	.585 [14.86]	103681-1
10	.685 [17.40]	103681-2
12	.785 [19.94]	103681-3
14	.885 [22.48]	103681-4
16	.985 [25.02]	103681-5
18	1.085 [27.56]	104500-1
20	1.185 [30.10]	104500-2
22	1.285 [32.64]	104500-3
24	1.385 [35.18]	104500-4
26	1.485 [37.72]	104500-5
28	1.585 [40.26]	104500-6
30	1.685 [42.80]	104500-7
32	1.785 [45.34]	104500-8
34	1.885 [47.88]	104500-9
40	2.185 [55.50]	1-104500-0
50	2.685 [68.20]	1-104500-1

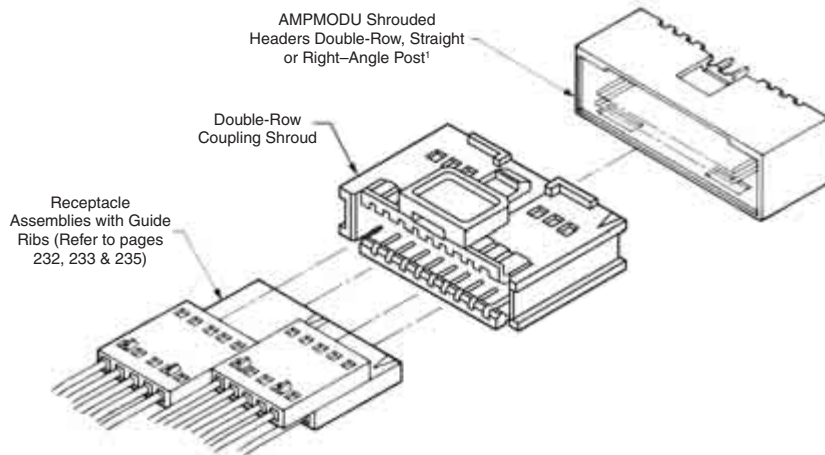

\*Mating AMPMODU Double-Row Shrouded Headers must have .318 [8.08] mating post length and .150 [3.81] dimension from centerline of last post to inside of end shroud wall.

**Typical Application of Double-Row Coupling Shroud and Mating AMPMODU Products**

**Note:** All part numbers are RoHS compliant.

## Panel Mount Pin Shrouds for MTE Pin Assemblies with Guide Ribs, Single-Row

### Material

Black thermoplastic, 94V-0 rated

**Technical Documents** —  
pages 277, 278

**Product Specification**  
108-25034

**Application Specification**  
114-25026

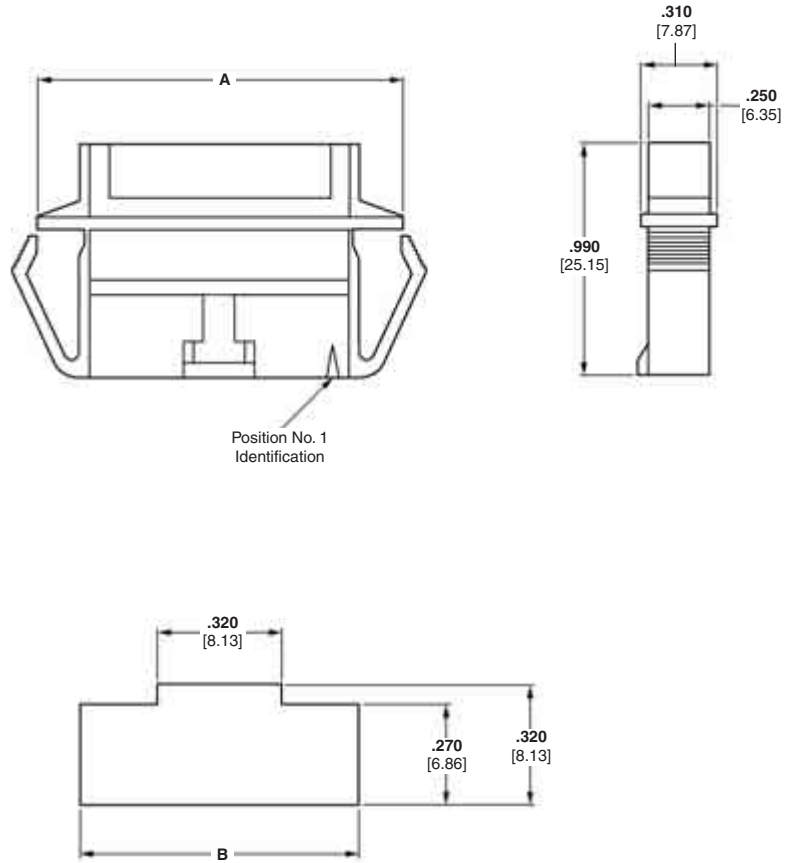

No. of Pos.	Dimensions		Panel Mount Pin Shroud
	A	B	
2	.735 [18.67]	.625 [15.88]	103682-1
3	.835 [21.21]	.725 [18.42]	103682-2
4	.935 [23.75]	.825 [20.96]	103682-3
5	1.035 [26.29]	.925 [23.50]	103682-4
6	1.135 [28.83]	1.025 [26.04]	103682-5
7	1.235 [31.37]	1.125 [28.58]	103682-6
8	1.335 [33.91]	1.225 [31.12]	103682-7
9	1.435 [36.45]	1.325 [33.66]	103682-8
10	1.535 [38.99]	1.425 [36.20]	103682-9
11	1.635 [41.53]	1.525 [38.74]	1-103682-0
12	1.735 [44.07]	1.625 [41.28]	1-103682-1
13	1.835 [46.61]	1.725 [43.82]	1-103682-2

No. of Pos.	Dimensions		Panel Mount Pin Shroud
	A	B	
14	1.935 [49.15]	1.825 [46.36]	1-103682-3
15	2.035 [51.69]	1.925 [48.90]	1-103682-4
16	2.135 [54.23]	2.025 [51.44]	1-103682-5
17	2.235 [56.77]	2.125 [53.98]	1-103682-6
18	2.335 [59.31]	2.225 [56.52]	1-103682-7
19	2.435 [61.85]	2.325 [59.06]	1-103682-8
20	2.535 [64.39]	2.425 [61.60]	1-103682-9
21	2.635 [66.93]	2.525 [64.14]	2-103682-0
22	2.735 [69.47]	2.625 [66.68]	2-103682-1
23	2.835 [72.01]	2.725 [69.22]	2-103682-2
24	2.935 [74.55]	2.825 [71.76]	2-103682-3
25	3.035 [77.09]	2.925 [74.30]	2-103682-4

**Note:** All part numbers are RoHS compliant.



**Panel Mount Pin Shrouds for MTE Pin Assemblies with Guide Ribs, Single-Row** (Continued)

**Material**

Black thermoplastic, 94V-0 rated

**Technical Documents** —  
pages 277, 278

**Product Specification**  
108-25034

**Application Specification**  
114-25026

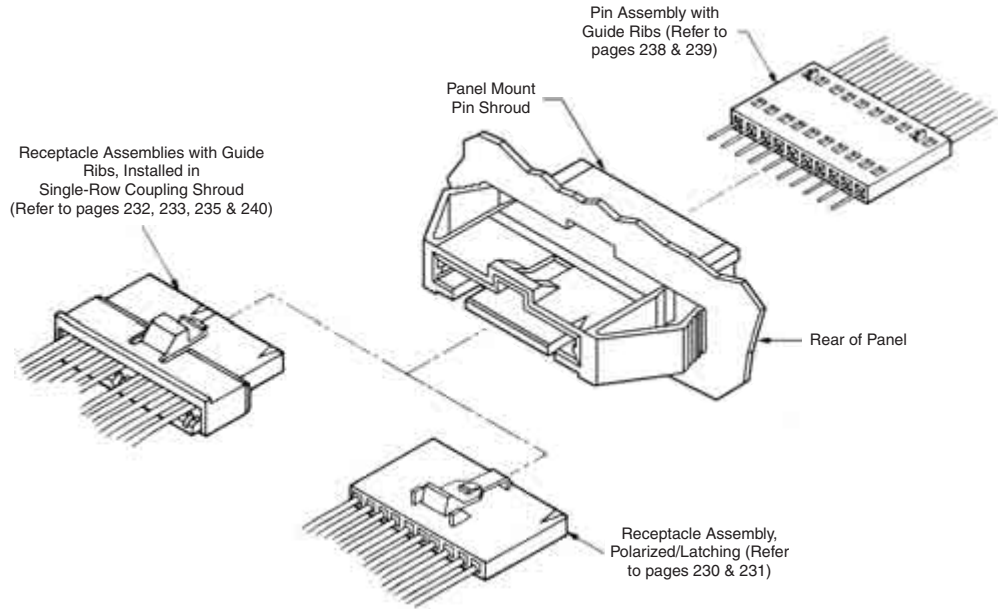

**Typical Application of Panel Mount Pin Shroud and Mating AMPMODU Products**

**MTE Headers, Shrouded Polarized/Latching,  
Single-Row .100 [2.54] Centerline**

**.025 [0.64] Square  
Straight Post (With or  
Without Swaged Tail)**

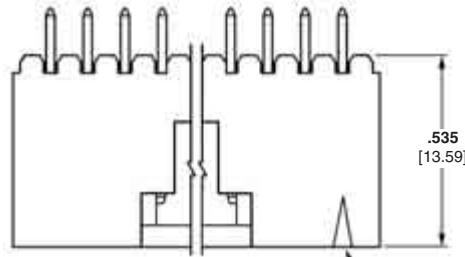

Position No. 1 Indicator



Swaged Retention Tail  
(See Note)

**Material and Finish**

**Housing** — Black thermoplastic, 94V-0 rated

**Posts** — Brass, plated as follows:

**Plating A** — Duplex plated .000030 [0.00076] gold on contact area, .000100 [0.00254] min. tin on solder area, with entire post underplated .000050 [0.00127] nickel

**Plating B** — Duplex plated .000015 [0.00038] gold on contact area, .000100 [0.00254] min. tin on solder area, with entire post underplated .000050 [0.00127] nickel

**Plating C** — .000100 [0.00254] tin over .000050 [0.00127] nickel on entire post

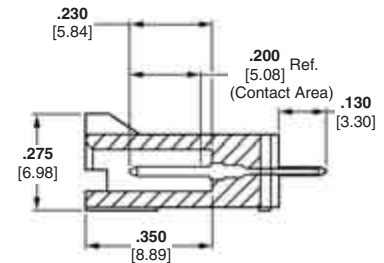
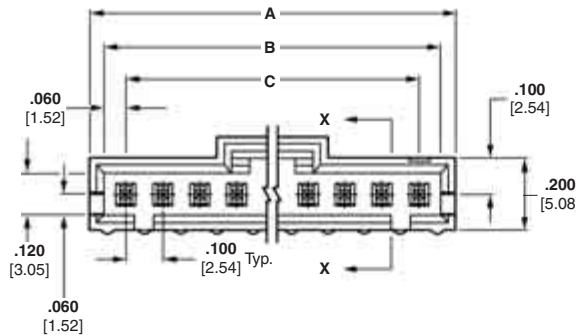

**Section X-X**

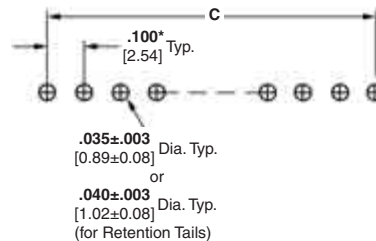

**Recommended PC Board Hole Layout**

\*±.003 [±0.08]; tolerances not to accumulate within one connector pattern.

**Note:** Swaged retention tails are provided in a minimum of two locations per header.

**Related Product Data**

**Mateable AMPMODU MTE Products** —

**Receptacle Assemblies (Polarized/Latching)** — pages 230, 231

**Receptacle Assemblies with Guide Ribs (installed in Single-Row Coupling Shroud)** — pages 232, 233, 235, 240

**Technical Documents** — pages 277, 278

**Product Specification**  
108-25034

**Application Specification**  
114-25026

## MTE Headers, Shrouded Polarized/Latching, Single-Row .100 [2.54] Centerline (Continued)

No. of Pos.	Dimensions			Polarized/Latching Header With Swage			Polarized/Latching Header Without Swage		
	A	B	C	Plating A	Plating B	Plating C	Plating A	Plating B	Plating C
2	.300 [7.62]	.220 [5.59]	.100 [2.54]	5-103908-1	5-104362-1	5-103669-1	5-103735-1	5-104363-1	5-103639-1
3	.400 [10.16]	.320 [8.13]	.200 [5.08]	5-103908-2	5-104362-2	5-103669-2	5-103735-2	5-104363-2	5-103639-2
4	.500 [12.70]	.420 [10.67]	.300 [7.62]	5-103908-3	5-104362-3	5-103669-3	5-103735-3	5-104363-3	5-103639-3
5	.600 [15.24]	.520 [13.21]	.400 [10.16]	5-103908-4	5-104362-4	5-103669-4	5-103735-4	5-104363-4	5-103639-4
6	.700 [17.78]	.620 [15.75]	.500 [12.70]	5-103908-5	5-104362-5	5-103669-5	5-103735-5	5-104363-5	5-103639-5
7	.800 [20.32]	.720 [18.29]	.600 [15.24]	5-103908-6	5-104362-6	5-103669-6	5-103735-6	5-104363-6	5-103639-6
8	.900 [22.86]	.820 [20.83]	.700 [17.78]	5-103908-7	5-104362-7	5-103669-7	5-103735-7	5-104363-7	5-103639-7
9	1.000 [25.40]	.920 [23.37]	.800 [20.32]	5-103908-8	5-104362-8	5-103669-8	5-103735-8	5-104363-8	5-103639-8
10	1.100 [27.94]	1.020 [25.91]	.900 [22.86]	5-103908-9	5-104362-9	5-103669-9	5-103735-9	5-104363-9	5-103639-9
11	1.200 [30.48]	1.120 [28.45]	1.000 [25.40]	6-103908-0	6-104362-0	6-103669-0	6-103735-0	6-104363-0	6-103639-0
12	1.300 [33.02]	1.220 [30.99]	1.100 [27.94]	6-103908-1	6-104362-1	6-103669-1	6-103735-1	6-104363-1	6-103639-1
13	1.400 [35.56]	1.320 [33.53]	1.200 [30.48]	6-103908-2	6-104909-2	6-103669-2	6-103735-2	6-104910-2	6-103639-2
14	1.500 [38.10]	1.420 [36.07]	1.300 [33.02]	6-103908-3	6-104909-3	6-103669-3	6-103735-3	6-104910-3	6-103639-3
15	1.600 [40.64]	1.520 [38.61]	1.400 [35.56]	6-103908-4	6-104909-4	6-103669-4	6-103735-4	6-104910-4	6-103639-4
16	1.700 [43.18]	1.620 [41.15]	1.500 [38.10]	6-103908-5	6-104909-5	6-103669-5	6-103735-5	6-104910-5	6-103639-5
17	1.800 [45.72]	1.720 [43.69]	1.600 [40.64]	6-103908-6	6-104909-6	6-103669-6	6-103735-6	6-104910-6	6-103639-6
18	1.900 [48.26]	1.820 [46.23]	1.700 [43.18]	6-103908-7	6-104909-7	6-103669-7	6-103735-7	6-104910-7	6-103639-7
19	2.000 [50.80]	1.920 [48.77]	1.800 [45.72]	6-103908-8	6-104909-8	6-103669-8	6-103735-8	6-104910-8	6-103639-8
20	2.100 [53.34]	2.020 [51.31]	1.900 [48.26]	6-103908-9	6-104909-9	6-103669-9	6-103735-9	6-104910-9	6-103639-9
21	2.200 [55.88]	2.120 [53.85]	2.000 [50.80]	7-103908-0	7-104909-0	7-103669-0	7-103735-0	7-104910-0	7-103639-0
22	2.300 [58.42]	2.220 [56.39]	2.100 [53.34]	7-103908-1	7-104909-1	7-103669-1	7-103735-1	7-104910-1	7-103639-1
23	2.400 [60.96]	2.320 [58.93]	2.200 [55.88]	7-103908-2	7-104909-2	7-103669-2	7-103735-2	7-104910-2	7-103639-2
24	2.500 [63.50]	2.420 [61.47]	2.300 [58.42]	7-103908-3	7-104909-3	7-103669-3	7-103735-3	7-104910-3	7-103639-3
25	2.600 [66.04]	2.520 [64.01]	2.400 [60.96]	7-103908-4	7-104909-4	7-103669-4	7-103735-4	7-104910-4	7-103639-4

Notes: 1. Selectively loaded headers are available, consult Tyco Electronics.  
2. Use Keying Tool No. 91417-1 to remove post for keying.

Note: All part numbers are RoHS compliant.

**MTE Headers, Shrouded Latching, Single-Row .100 [2.54] Centerline**

**.025 [0.64] Square Right-Angle Post**



**Material and Finish**

**Housing** — Black thermoplastic, 94V-0 rated

**Posts** — Brass, plated as follows:

**Plating A** — Duplex plated .000030 [0.00076] gold on contact area, .000100 [0.00254] min. tin on solder area, with entire post underplated .000050 [0.00127] nickel

**Plating B** — Duplex plated .000015 [0.00038] gold on contact area, .000100 [0.00254] min. tin on solder area, with entire post underplated .000050 [0.00127] nickel

**Plating C** — .000100 [0.00254] tin over .000050 [0.00127] nickel on entire post

**With Holddown**

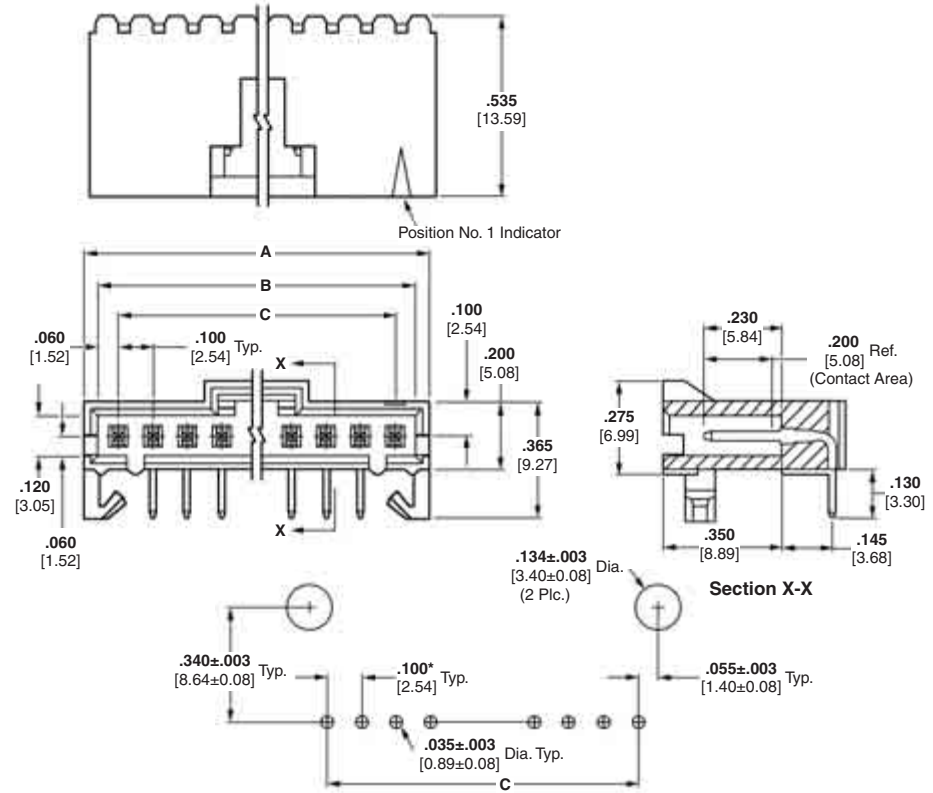

**Recommended PC Board Hole Layout**  
(PC board thickness (for Holddown Feature) is .062±.008 [1.57±0.20])  
\*±.003 [±0.08]; tolerance not to accumulate within one connector pattern.

MTE Headers

5



**Related Product Data**

**Mateable AMPMODU MTE Products** —

**Receptacle Assemblies (Latching)** — pages 230, 231  
**Receptacle Assemblies with Guide Ribs (installed in Single-Row Coupling Shroud)** — pages 232, 233, 235, 240

**Technical Documents** — pages 277, 278

**Product Specification**  
108-25034

**Application Specification**  
114-25026

**Without Holddown**

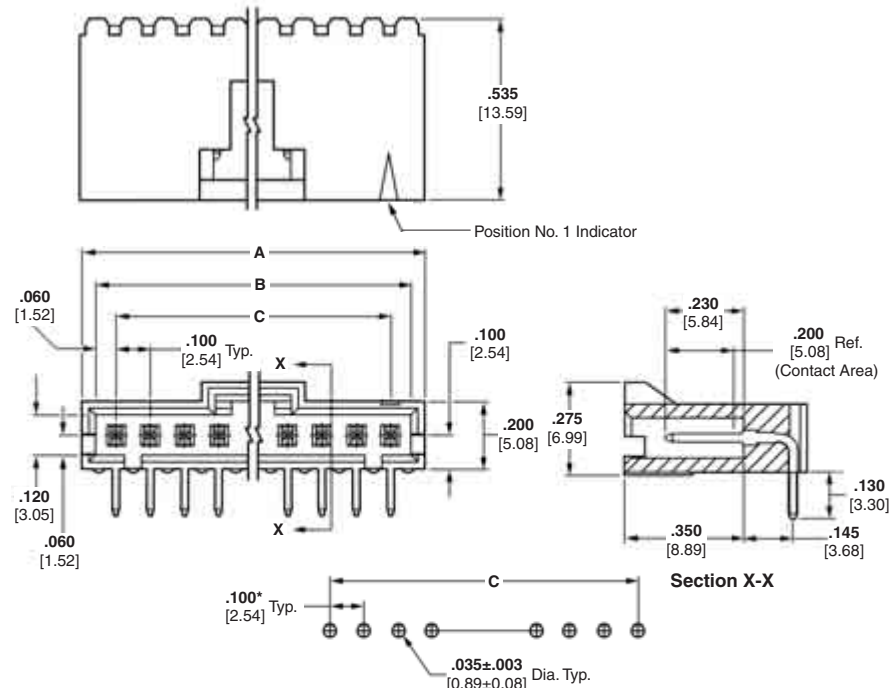

**Recommended PC Board Hole Layout**  
\*±.003 [±0.08]; tolerance not to accumulate within one connector pattern.

**MTE Headers, Shrouded Latching, Single-Row .100 [2.54] Centerline** (Continued)

No. of Pos.	Dimensions			Latching Header With Hold Down			Latching Header Without Hold Down		
	A	B	C	Plating A	Plating B	Plating C	Plating A	Plating B	Plating C
2	.300 [7.62]	.220 [5.59]	.100 [2.54]	5-103904-1	5-103673-1	5-103672-1	5-104935-5	5-103635-1	5-103634-1
3	.400 [10.16]	.320 [8.13]	.200 [5.08]	5-103904-2	5-103673-2	5-103672-2	5-104935-3	5-103635-2	5-103634-2
4	.500 [12.70]	.420 [10.67]	.300 [7.62]	5-103904-3	5-103673-3	5-103672-3	5-104935-1	5-103635-3	5-103634-3
5	.600 [15.24]	.520 [13.21]	.400 [10.16]	5-103904-4	5-103673-4	5-103672-4	5-104935-6	5-103635-4	5-103634-4
6	.700 [17.78]	.620 [15.75]	.500 [12.70]	5-103904-5	5-103673-5	5-103672-5	5-104935-7	5-103635-5	5-103634-5
7	.800 [20.32]	.720 [18.29]	.600 [15.24]	5-103904-6	5-103673-6	5-103672-6	5-104935-8	5-103635-6	5-103634-6
8	.900 [22.86]	.820 [20.83]	.700 [17.78]	5-103904-7	5-103673-7	5-103672-7	5-104935-2	5-103635-7	5-103634-7
9	1.000 [25.40]	.920 [23.37]	.800 [20.32]	5-103904-8	5-103673-8	5-103672-8	5-104935-9	5-103635-8	5-103634-8
10	1.100 [27.94]	1.020 [25.91]	.900 [22.86]	5-103904-9	5-103673-9	5-103672-9	6-104935-0	5-103635-9	5-103634-9
11	1.200 [30.48]	1.120 [28.45]	1.000 [25.40]	6-103904-0	6-103673-0	6-103672-0	6-104935-1	6-103635-0	6-103634-0
12	1.300 [33.02]	1.220 [30.99]	1.100 [27.94]	6-103904-1	6-103673-1	6-103672-1	5-104935-4	6-103635-1	6-103634-1
13	1.400 [35.56]	1.320 [33.53]	1.200 [30.48]	6-103904-2	6-103673-2	6-103672-2	6-104935-2	6-103635-2	6-103634-2
14	1.500 [38.10]	1.420 [36.07]	1.300 [33.02]	6-103904-3	6-103673-3	6-103672-3	6-104935-3	6-103635-3	6-103634-3
15	1.600 [40.64]	1.520 [38.61]	1.400 [35.56]	6-103904-4	6-103673-4	6-103672-4	6-104935-4	6-103635-4	6-103634-4
16	1.700 [43.18]	1.620 [41.15]	1.500 [38.10]	6-103904-5	6-103673-5	6-103672-5	6-104935-5	6-103635-5	6-103634-5
17	1.800 [45.72]	1.720 [43.69]	1.600 [40.64]	6-103904-6	6-103673-6	6-103672-6	6-104935-6	6-103635-6	6-103634-6
18	1.900 [48.26]	1.820 [46.23]	1.700 [43.18]	6-103904-7	6-103673-7	6-103672-7	6-104935-7	6-103635-7	6-103634-7
19	2.000 [50.80]	1.920 [48.77]	1.800 [45.72]	6-103904-8	6-103673-8	6-103672-8	6-104935-8	6-103635-8	6-103634-8
20	2.100 [53.34]	2.020 [51.31]	1.900 [48.26]	6-103904-9	6-103673-9	6-103672-9	6-104935-9	6-103635-9	6-103634-9
21	2.200 [55.88]	2.120 [53.85]	2.000 [50.80]	7-103904-0	7-103673-0	7-103672-0	7-104935-0	7-103635-0	7-103634-0
22	2.300 [58.42]	2.220 [56.39]	2.100 [53.34]	7-103904-1	7-103673-1	7-103672-1	7-104935-1	7-103635-1	7-103634-1
23	2.400 [60.96]	2.320 [58.93]	2.200 [55.88]	7-103904-2	7-103673-2	7-103672-2	7-104935-2	7-103635-2	7-103634-2
24	2.500 [63.50]	2.420 [61.47]	2.300 [58.42]	7-103904-3	7-103673-3	7-103672-3	7-104935-3	7-103635-3	7-103634-3
25	2.600 [66.04]	2.520 [64.01]	2.400 [60.96]	7-103904-4	7-103673-4	7-103672-4	7-104935-4	7-103635-4	7-103634-4

Notes: 1. Selectively loaded headers are available, consult Tyco Electronics.  
 2. Use Keying Tool No. 91417-1 to remove post for keying.

Note: All part numbers are RoHS compliant.

**MTE Headers, Shrouded Latching, Single-Row .100 [2.54] Centerline**

**.025 [0.64] Square Straight Post (With Swaged Tails and PC Board Orientation)**

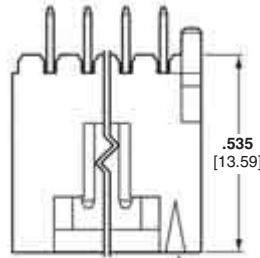

Swaged Retention Tail  
(See Note)

Position No. 1 Indicator

**Material and Finish**

**Housing** — Black thermoplastic, 94V-0 rated

**Posts** — Brass, plated .000100 [0.00254] tin over .000050 [0.00127] nickel on entire post

**Related Product Data**

**Mateable AMPMODU MTE Products** —

**Receptacle Assemblies (Polarized/Latching)** — pages 230, 231

**Receptacle Assemblies with Guide Ribs (installed in Single-Row Coupling Shroud)** — pages 232, 233, 235, 240

**Technical Documents** — pages 277, 278

**Product Specification** 108-25034

**Application Specification** 114-25026

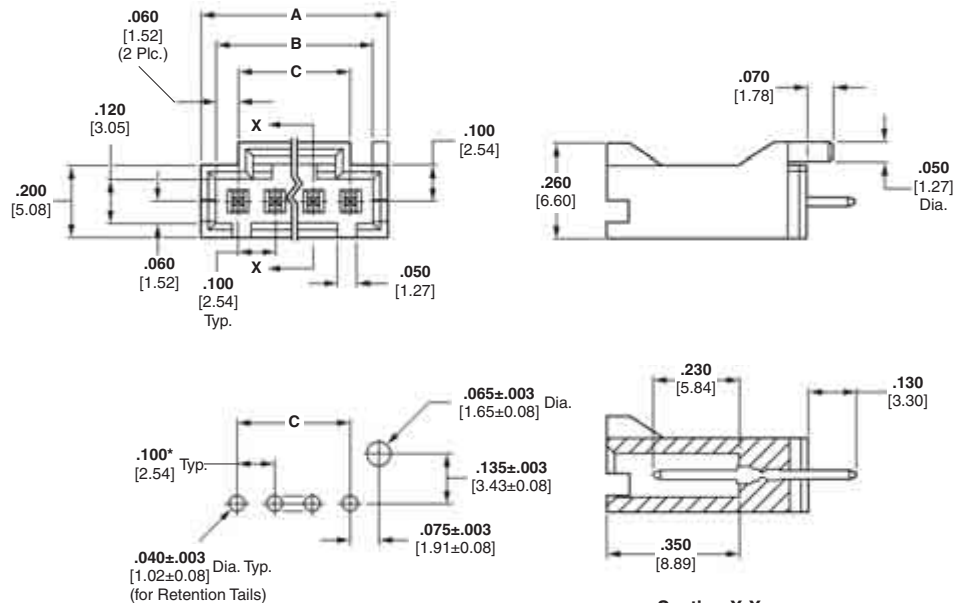

**Recommended PC Board Hole Layout**

\*±.003 [±0.08]; tolerances not to accumulate within one connector pattern.

**Note:** Swaged retention tails are provided in a minimum of two locations per header.

No. of Pos.	Dimensions			Latching Header
	A	B	C	
2	.300 [7.62]	.220 [5.59]	.100 [2.54]	5-104450-1
3	.400 [10.16]	.320 [8.13]	.200 [5.08]	5-104450-2
4	.500 [12.70]	.420 [10.67]	.300 [7.62]	5-104450-3
5	.600 [15.24]	.520 [13.21]	.400 [10.16]	5-104450-4
6	.700 [17.78]	.620 [15.75]	.500 [12.70]	5-104450-5
7	.800 [20.32]	.720 [18.29]	.600 [15.24]	5-104450-6
8	.900 [22.86]	.820 [20.83]	.700 [17.78]	5-104450-7
9	1.000 [25.40]	.920 [23.37]	.800 [20.32]	5-104450-8
10	1.100 [27.94]	1.020 [25.91]	.900 [22.86]	5-104450-9

**Note:** All part numbers are RoHS compliant.



**MTE Headers, Through-hole, Surface Mount Compatible,  
Shrouded Polarized/Latching, Single-Row .100 [2.54] Centerline**

**.025 [0.64] Square Straight Post (With Swaged Tails and PC Board Orientation)**



**Material and Finish**

**Housing** — Black thermoplastic, 94V-0 rated

**Posts** — Brass, duplex plated .000015 [0.00038] gold on contact area, .000100 [0.00254] min tin on solder tail, with entire post underplated .000050 [0.00127] nickel

**Related Product Data**

**Mateable AMPMODU MTE Products** —

**Receptacle Assemblies with Guide Ribs (installed in Single-Row Coupling Shroud)** — pages 232, 233, 235, 240

**Receptacle Assemblies (Polarized Latching)** — pages 230, 231

**Technical Documents** — pages 277, 278

**Product Specification** 108-25034

**Application Specification** 114-25026

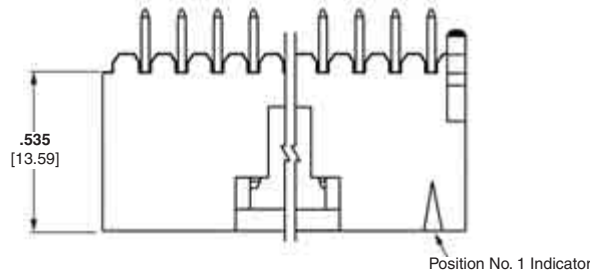

Swaged Retention Tail (See Note)

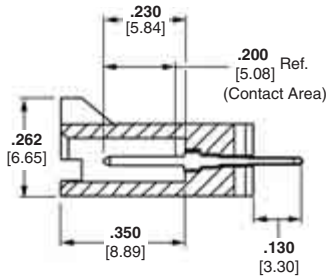
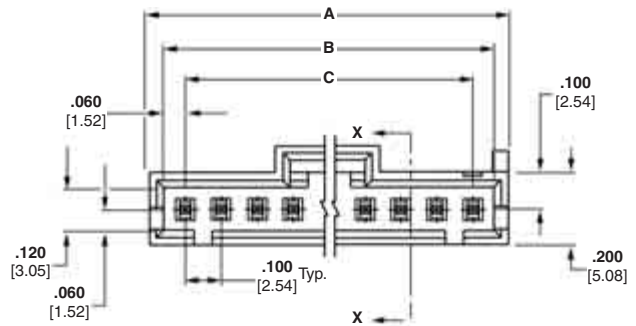

Section X-X

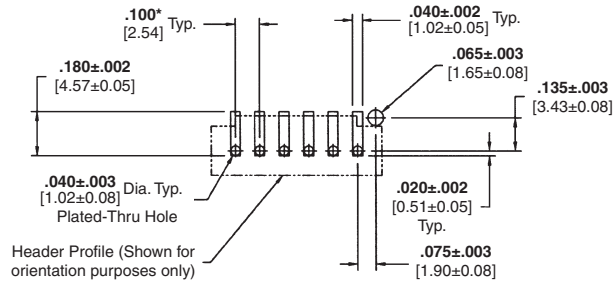

**Recommended PC Board Hole Layout (Stencil Thickness = .010 [0.25])**

\*±.003 [±0.08] tolerance not to accumulate within one connector pattern

No. of Pos.	Dimensions			Polarized/Latching Header, High-Temp
	A	B	C	
2	.300 [7.62]	.220 [5.59]	.100 [2.54]	5-104809-1
3	.400 [10.16]	.320 [8.13]	.200 [5.08]	5-104809-2
4	.500 [12.70]	.420 [10.67]	.300 [7.62]	5-104809-3
5	.600 [15.24]	.520 [13.21]	.400 [10.16]	5-104809-4
6	.700 [17.78]	.620 [15.75]	.500 [12.70]	5-104809-5
7	.800 [20.32]	.720 [18.29]	.600 [15.24]	5-104809-6
8	.900 [22.86]	.820 [20.83]	.700 [17.78]	5-104809-7
9	1.000 [25.40]	.920 [23.37]	.800 [20.32]	5-104809-8
10	1.100 [27.94]	1.020 [25.91]	.900 [22.86]	5-104809-9
11	1.200 [30.48]	1.120 [28.45]	1.000 [25.40]	6-104809-0
12	1.300 [33.02]	1.220 [30.99]	1.100 [27.94]	6-104809-1

**Note:** All part numbers are RoHS compliant.

**MTE Headers, Polarized/Latching, Through-Hole,  
Surface Mount Compatible, Single-Row, .100 [2.54] Centerline**

**.025 [0.64] Square  
Right-Angle Post (With  
Holddown)**



**Material and Finish**

**Housing** — Black thermoplastic, 94V-0 rated

**Posts** — Brass, duplex plated .000015 [0.00038] gold on contact area, .000100 [0.00254] min. tin on solder tail, with entire post underplated .000050 [0.00127] nickel

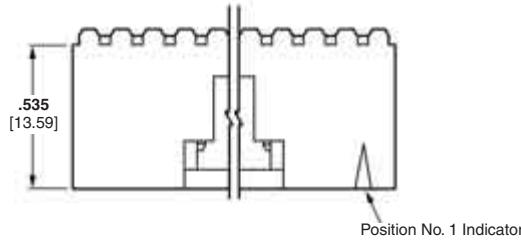

**Related Product Data**

**Mateable AMPMODU MTE Products** —

**Receptacle Assemblies (Polarized/Latching)** — pages 230, 231

**Receptacle Assemblies with Guide Ribs (installed in Single-Row Coupling Shroud)** — pages 232, 233, 235, 240

**Technical Documents** — pages 277, 278

**Product Specification** 108-25034

**Application Specification** 114-25026



\*±.003 [±0.08]; tolerance is not to accumulate within one connector pattern.

No. of Pos.	Dimensions			Right-Angle Header with Hold Down
	A	B	C	
2	.300 [7.62]	.220 [5.59]	.100 [2.54]	5-104361-1
3	.400 [10.16]	.320 [8.13]	.200 [5.08]	5-104361-2
4	.500 [12.70]	.420 [10.67]	.300 [7.62]	5-104361-3
5	.600 [15.24]	.520 [13.21]	.400 [10.16]	5-104361-4
6	.700 [17.78]	.620 [15.75]	.500 [12.70]	5-104361-5
7	.800 [20.32]	.720 [18.29]	.600 [15.24]	5-104361-6
8	.900 [22.86]	.820 [20.83]	.700 [17.78]	5-104361-7
9	1.000 [25.40]	.920 [23.37]	.800 [20.32]	5-104361-8
10	1.100 [27.94]	1.020 [25.91]	.900 [22.86]	5-104361-9
11	1.200 [30.48]	1.120 [28.44]	1.000 [25.40]	6-104361-0
12	1.300 [33.02]	1.220 [30.99]	1.100 [27.94]	6-104361-1
13	1.400 [35.56]	1.320 [33.53]	1.200 [30.48]	6-104361-2

No. of Pos.	Dimensions			Right-Angle Header with Hold Down
	A	B	C	
14	1.500 [38.10]	1.420 [36.07]	1.300 [33.02]	6-104361-3
15	1.600 [40.64]	1.520 [38.61]	1.400 [35.56]	6-104361-4
16	1.700 [43.18]	1.620 [41.15]	1.500 [38.10]	6-104361-5
17	1.800 [45.72]	1.720 [43.69]	1.600 [40.64]	6-104361-6
18	1.900 [48.26]	1.820 [46.23]	1.700 [43.18]	6-104361-7
19	2.000 [50.80]	1.920 [48.77]	1.800 [45.72]	6-104361-8
20	2.100 [53.34]	2.020 [51.31]	1.900 [48.26]	6-104361-9
21	2.200 [55.88]	2.120 [53.85]	2.000 [50.80]	7-104361-0
22	2.300 [58.42]	2.220 [56.39]	2.100 [53.34]	7-104361-1
23	2.400 [60.96]	2.320 [58.93]	2.200 [55.88]	7-104361-2
24	2.500 [63.50]	2.420 [61.47]	2.300 [58.42]	7-104361-3
25	2.600 [66.04]	2.520 [64.01]	2.400 [60.96]	7-104361-4

**Note:** All part numbers are RoHS compliant.

**MTE Headers, Right-Angle, Polarized/Latching, Surface Mount**



**Material and Finish**

**Housing** — Black thermoplastic, 94V-0 rated

**Posts** — Brass, plated as follows:

**Plating A** — Duplex plated .000030 [.00076] gold on contact area, .000100 [.00254] min. tin on solder area, with entire post underplated .000050 [.00127] nickel.

**Plating B** — Duplex plated .000015 [.00038] gold on contact area, .000100 [.00254] min. tin on solder area, with entire post underplated .000050 [.00127] nickel.

**Plating C** — .000100 [.00254] tin over .000050 [.00127] nickel on entire post

**Recommended PC Board Layout**

(Refer to MTE Application Spec. 114-25026 for Stencil Aperture Layout Using .006 [0.152] or .008 [0.203] Stencil Thickness)

**Related Product Data**

**Mateable AMPMODU MTE Products** —

**Receptacle Assemblies (Polarized/Latching)** — pages 230, 231

**Receptacle Assemblies with Guide Ribs (installed in Single-Row Coupling Shroud)** — pages 232, 233, 235, 240

**Technical Documents** — pages 277, 278

**Product Specification** 108-25034

**Application Specification** 114-25026

**Note:** All part numbers are RoHS compliant.

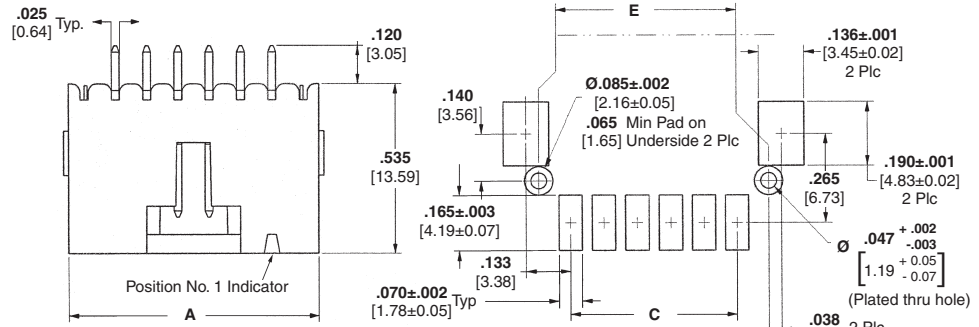

**Recommended PC Board Layout**

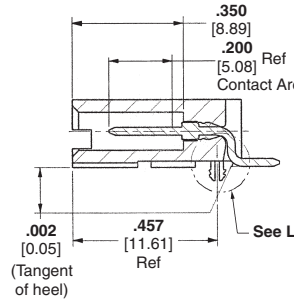
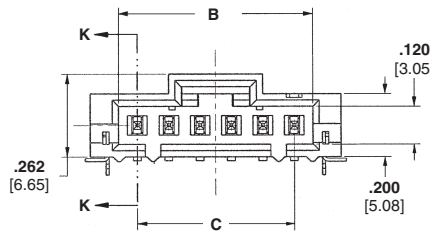

**Section K-K**

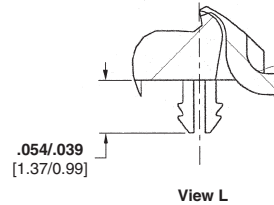
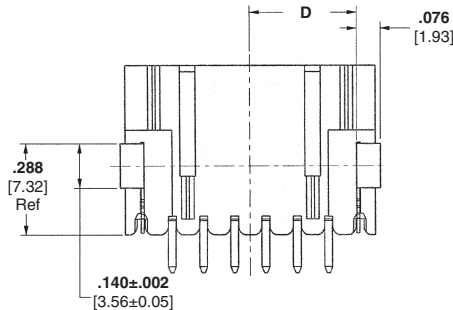

**View L**

No. of Pos.	Dimensions					Right-Angle Latching SMT Headers		
	A	B	C	D	E	Plating A	Plating B	Plating C
2	.400 [10.16]	.220 [5.59]	.100 [2.54]	.140 [3.56]	.290 [7.37]	5-147323-1	5-147278-1	5-147324-1
3	.500 [12.70]	.320 [8.13]	.200 [5.08]	.190 [4.83]	.390 [9.91]	5-147323-2	5-147278-2	5-147324-2
4	.600 [15.24]	.420 [10.67]	.300 [7.62]	.240 [6.10]	.490 [12.45]	5-147323-3	5-147278-3	5-147324-3
5	.700 [17.78]	.520 [13.21]	.400 [10.16]	.290 [7.37]	.590 [14.99]	5-147323-4	5-147278-4	5-147324-4
6	.800 [20.32]	.620 [15.75]	.500 [12.70]	.340 [8.64]	.690 [17.53]	5-147323-5	5-147278-5	5-147324-5
7	.900 [22.86]	.720 [18.29]	.600 [15.24]	.390 [9.91]	.790 [20.07]	5-147323-6	5-147278-6	5-147324-6
8	1.000 [25.40]	.820 [20.83]	.700 [17.78]	.440 [11.18]	.890 [22.61]	5-147323-7	5-147278-7	5-147324-7
9	1.100 [27.94]	.920 [23.37]	.800 [20.32]	.490 [12.45]	.990 [25.15]	5-147323-8	5-147278-8	5-147324-8
10	1.200 [30.48]	1.020 [25.91]	.900 [22.86]	.540 [13.72]	1.090 [27.69]	5-147323-9	5-147278-9	5-147324-9
11	1.300 [33.02]	1.120 [28.45]	1.000 [25.40]	.590 [14.99]	1.190 [30.23]	6-147323-0	6-147278-0	6-147324-0
12	1.400 [35.56]	1.220 [30.99]	1.100 [27.94]	.640 [16.26]	1.290 [32.77]	6-147323-1	6-147278-1	6-147324-1
13	1.500 [38.10]	1.320 [33.53]	1.200 [30.48]	.690 [17.53]	1.390 [35.31]	6-147323-2	6-147278-2	6-147324-2
14	1.600 [40.64]	1.420 [36.07]	1.300 [33.02]	.740 [18.80]	1.490 [37.85]	6-147323-3	6-147278-3	6-147324-3
15	1.700 [43.18]	1.520 [38.61]	1.400 [35.56]	.790 [20.07]	1.590 [40.39]	6-147323-4	6-147278-4	6-147324-4
16	1.800 [45.72]	1.620 [41.15]	1.500 [38.10]	.840 [21.34]	1.690 [42.93]	6-147323-5	6-147278-5	6-147324-5
17	1.900 [48.26]	1.720 [43.69]	1.600 [40.64]	.890 [22.61]	1.790 [45.47]	6-147323-6	6-147278-6	6-147324-6
18	2.000 [50.80]	1.820 [46.23]	1.700 [43.18]	.940 [23.88]	1.890 [48.01]	6-147323-7	6-147278-7	6-147324-7
19	2.100 [53.34]	1.920 [48.77]	1.800 [45.72]	.990 [25.15]	1.990 [50.55]	6-147323-8	6-147278-8	6-147324-8
20	2.200 [55.88]	2.020 [51.31]	1.900 [48.26]	1.040 [26.42]	2.090 [53.09]	6-147323-9	6-147278-9	6-147324-9
21	2.300 [58.42]	2.120 [53.85]	2.000 [50.80]	1.090 [27.69]	2.190 [55.63]	7-147323-0	7-147278-0	7-147324-0
22	2.400 [60.96]	2.220 [56.39]	2.100 [53.34]	1.140 [28.96]	2.290 [58.17]	7-147323-1	7-147278-1	7-147324-1
23	2.500 [63.50]	2.320 [58.93]	2.200 [55.88]	1.190 [30.23]	2.390 [60.71]	7-147323-2	7-147278-2	7-147324-2
24	2.600 [66.04]	2.420 [61.47]	2.300 [58.42]	1.240 [31.50]	2.490 [63.25]	7-147323-3	7-147278-3	7-147324-3
25	2.700 [68.58]	2.520 [64.01]	2.400 [60.96]	1.290 [32.77]	2.590 [65.79]	7-147323-4	7-147278-4	7-147324-4

**MTE Headers, Vertical, Polarized/Latching, Surface Mount**



**Material and Finish**

**Housing** — Black thermoplastic, 94V-0 rated

**Posts** — Brass, plated as follows:

**Plating A** — Duplex plated .000030 [.00076] gold on contact area, .000100 [.00254] min. tin on solder area, with entire post underplated .000050 [.00127] nickel.

**Plating B** — Duplex plated .000015 [.00038] gold on contact area, .000100 [.00254] min. tin on solder area, with entire post underplated .000050 [.00127] nickel.

**Plating C** — .000100 [.00254] tin over .000050 [.00127] nickel on entire post

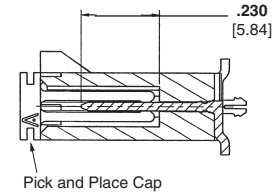
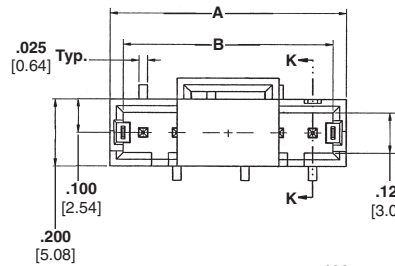
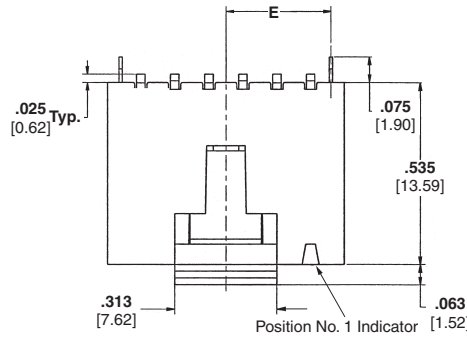

Section K-K

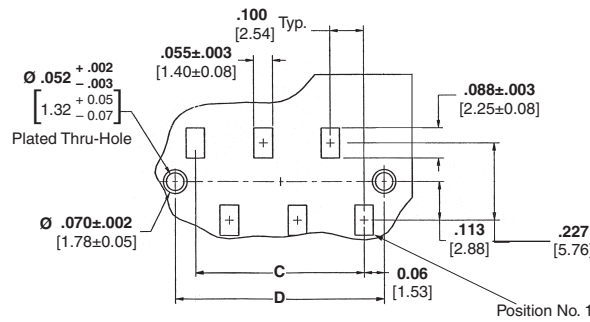

Recommended PC Board Layout

**Recommended PC Board Layout**

(Refer to MTE Application Spec. 114-25026 for Stencil Aperture Layout using .006 [0.152] or .008 [0.203] stencil thickness

**Related Product Data**

**Mateable AMPMODU MTE Products** —

**Receptacle Assemblies (Polarized/Latching)** — pages 230, 231

**Receptacle Assemblies with Guide Ribs (installed in Single-Row Coupling Shroud)** — pages 232, 233, 235, 240

**Technical Documents** — pages 277, 278

**Product Specification** 108-25034

**Application Specification** 114-25026

No. of Pos.	Dimensions					Vertical SMT Headers		
	A	B	C	D	E	Plating A	Plating B	Plating C
2	.300[7.62]	.220[5.59]	.100[2.54]	.220[5.60]	.110[2.80]	5-1375583-1	5-1375582-1	5-1375549-1
3	.400[10.16]	.320[8.13]	.200[5.08]	.320[8.14]	.160[4.07]	5-1375583-2	5-1375582-2	5-1375549-2
4	.500[12.70]	.420[10.67]	.300[7.62]	.420[10.68]	.210[5.34]	5-1375583-3	5-1375582-3	5-1375549-3
5	.600[15.24]	.520[13.21]	.400[10.16]	.520[13.22]	.260[6.61]	5-1375583-4	5-1375582-4	5-1375549-4
6	.700[17.78]	.620[15.75]	.500[12.70]	.620[15.76]	.310[7.88]	5-1375583-5	5-1375582-5	5-1375549-5
7	.800[20.32]	.720[18.29]	.600[15.24]	.720[18.30]	.360[9.15]	5-1375583-6	5-1375582-6	5-1375549-6
8	.900[22.86]	.820[20.83]	.700[17.78]	.820[20.84]	.410[10.42]	5-1375583-7	5-1375582-7	5-1375549-7
9	1.000[25.40]	.920[23.37]	.800[20.32]	.920[23.38]	.460[11.69]	5-1375583-8	5-1375582-8	5-1375549-8
10	1.100[27.94]	1.020[25.91]	.900[22.86]	1.020[25.92]	.510[12.96]	5-1375583-9	5-1375582-9	5-1375549-9
11	1.200[30.48]	1.120[28.45]	1.000[25.40]	1.120[28.46]	.560[14.23]	6-1375583-0	6-1375582-0	6-1375549-0
12	1.300[33.02]	1.220[30.99]	1.100[27.94]	1.220[31.00]	.610[15.50]	6-1375583-1	6-1375582-1	6-1375549-1
13	1.400[35.56]	1.320[33.53]	1.200[30.48]	1.320[33.54]	.660[16.77]	6-1375583-2	6-1375582-2	6-1375549-2
14	1.500[38.10]	1.420[36.07]	1.300[33.02]	1.420[36.08]	.710[18.04]	6-1375583-3	6-1375582-3	6-1375549-3
15	1.600[40.64]	1.520[38.61]	1.400[35.56]	1.520[38.62]	.760[19.31]	6-1375583-4	6-1375582-4	6-1375549-4
16	1.700[43.18]	1.620[41.15]	1.500[38.10]	1.620[41.16]	.810[20.58]	6-1375583-5	6-1375582-5	6-1375549-5
17	1.800[45.72]	1.720[43.69]	1.600[40.64]	1.720[43.70]	.860[21.85]	6-1375583-6	6-1375582-6	6-1375549-6
18	1.900[48.26]	1.820[46.23]	1.700[43.18]	1.820[46.24]	.910[23.12]	6-1375583-7	6-1375582-7	6-1375549-7
19	2.000[50.80]	1.920[48.77]	1.800[45.72]	1.920[48.78]	.960[24.39]	6-1375583-8	6-1375582-8	6-1375549-8
20	2.100[53.34]	2.020[51.31]	1.900[48.26]	2.020[51.32]	1.010[25.66]	6-1375583-9	6-1375582-9	6-1375549-9
21	2.200[55.88]	2.120[53.85]	2.000[50.80]	2.120[53.86]	1.060[26.93]	7-1375583-0	7-1375582-0	7-1375549-0
22	2.300[58.42]	2.220[56.39]	2.100[53.34]	2.220[56.40]	1.110[28.20]	7-1375583-1	7-1375582-1	7-1375549-1
23	2.400[60.96]	2.320[58.93]	2.200[55.88]	2.320[58.94]	1.160[29.47]	7-1375583-2	7-1375582-2	7-1375549-2
24	2.500[63.50]	2.420[61.47]	2.300[58.42]	2.420[61.48]	1.210[30.74]	7-1375583-3	7-1375582-3	7-1375549-3
25	2.600[66.04]	2.520[64.01]	2.400[60.96]	2.520[64.02]	1.260[32.01]	7-1375583-4	7-1375582-4	7-1375549-4

**Note:** All part numbers are RoHS compliant.

**Interchangeable Contacts, Wire Crimp (Snap-In)**

**Material and Finish**

Copper alloy C7025, plated as follows:

**Plating A** — Duplex plated .000030 [0.00076] min. gold on contact area, .000050 [0.00127] min. tin in crimp area, with entire contact underplated .000050 [0.00127] min. nickel

**Plating B** — Duplex plated .000015 [0.00038] min. gold on contact area, .000050 [0.00127] min. tin in crimp area, with entire contact underplated .000050 [0.00127] min. nickel

**Plating C** — .000100 [0.00254] min. tin over .000050 [0.00127] min. nickel on entire contact



**Keying Plug**

**Part No. 104072-1**

Ten plugs are supplied per strip. Order quantity reflects the number of strips required.



**Extraction/Lance Reset  
Tool No. 843477-1**

**Short Point Receptacles**

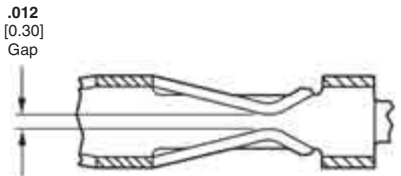
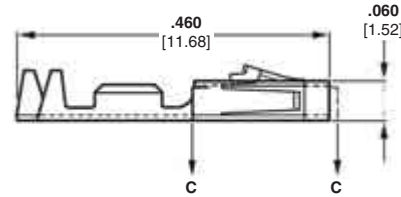
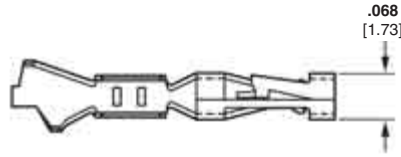

**Section C - C**

**Related Product Data**

**Performance Characteristics** — page 221

**Housings used in** — Short Point—pages 223, 224

**AMPMODU MTE Unloaded Housings** — pages 228-233

**Application Tooling**— pages 270-272

**Technical Documents** — pages 277, 278

**Product Specification**  
108-1472, 108-1472-1

**Application Specification**  
114-25038

Wire Size Range AWG [mm <sup>2</sup> ]	Ins. Dia. Range	Finish	Contact Part No. (Standard Pressure)		Heavy Duty Miniature Applicator for AMP-O-ELECTRIC Machine*	Applicator for AMP-O-MATIC Stripper/Crimper Machine	Hand Tool Nos.
			Strip Form	Loose Piece			
32-28 0.03-0.08	.025-.060 0.64-1.52	Plating A	1-104481-1	1-104481-3	567296-2	466980-1	91518-1
		Plating B	1-104481-0	1-104481-2			
		Plating C	5-104481-2	5-104481-6			
26-22 0.13-0.3	.025-.060 0.64-1.52	Plating A	1-104480-3	1-104480-6	567297-2	466981-1	91518-1
		Plating B	1-104480-2	1-104480-5			
		Plating C	1-104480-7	1-104480-4			
24-20 0.2-0.5	.025-.060 0.64-1.52	Plating A	1-104479-0	1-104479-3	567298-2	466982-1	91551-1
		Plating B	1-104479-9	1-104479-2			
		Plating C	1-104479-8	1-104479-1			

\*For use with Model "K" machines. Call the Technical Support Center (1-800-522-6752) for part nos. of applicators for use with the Model "G" machines (shown on page 270), as well as other bench machines and fully automatic AMPOMATOR lead making machines.

**Note:** These wire crimp contacts can be intermixed with insulation displacement crimp contacts.

**Note:** All part numbers are RoHS compliant.



**Interchangeable Contacts, Wire Crimp (Snap-In) (Continued)**

**Material and Finish**

Phosphor bronze, plated as follows:

**Plating A** — Duplex plated .000030 [0.00076] gold on contact area, .000030 [0.00076] min. tin in crimp area, with entire contact underplated .000050 [0.00127] nickel

**Plating B** — Duplex plated .000015 [0.00038] gold on contact area, .000030 [0.00076] min. tin on solder area, with entire contact underplated .000050 [0.00127] nickel

**Plating C** — .000100 [0.00254] tin over .000050 [0.00127] nickel on entire contact

**Pins**

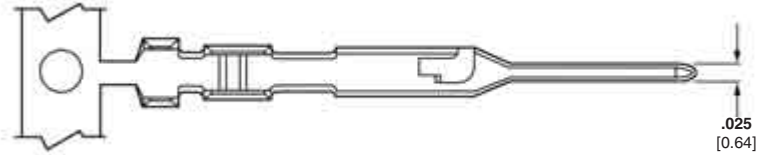

Extraction/Lance Reset  
Tool No. 843477-1

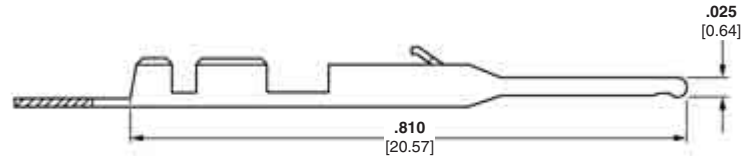

**Related Product Data**

**Performance Characteristics** —  
page 221

**AMPMODU MTE Unloaded  
Housings** — pages 228-233

**Application Tooling** —  
pages 270-272

**Technical Documents** —  
pages 277, 278

**Product Specification**  
108-25034

**Application Specification**  
114-25026

Wire Size Range	Ins. Dia. Range	Finish	Contact Part No. (Standard Pressure)		Heavy Duty Miniature Applicator for AMP-O-LECTRIC Machine*	Applicator for AMP-O-MATIC Stripper/ Crimper Machine	Hand Tool Nos.
			Strip Form	Loose Piece			
32-28 0.03-0.08	.025-.054 0.64-1.37	Plating A	5-104506-6	5-104506-7	—	—	58342-2
		Plating B	5-104506-4	5-104506-5			
		Plating C	5-104506-2	5-104506-3			
26-22 0.14-0.32	.036-.054 0.91-1.37	Plating A	5-104505-6	5-104505-7	567239-2	466983-1	91531-1
		Plating B	5-104505-4	5-104505-5			
		Plating C	5-104505-2	5-104505-3			

\*For use with AMP-O-LECTRIC Model "K" machines. Call Technical Support Center (1-800-522-6752) for part nos. of applicators for use with the AMP-O-LECTRIC Model "G" machines (shown on page 270), as well as other bench machines and fully automatic AMPOMATOR lead making machines.  
**Note:** These wire crimp contacts can be intermixed with insulation displacement crimp contacts.

**Note:** All part numbers are RoHS compliant.



**MT and Shielded MT Interconnection System**

**Product Facts**

- Full line of mass termination tooling offers lowest installed cost for most production needs
- Dual cantilever beams with anti-overstress features provide redundant contact of mating post and limit beam deflection, preventing permanent deformation
- Redundant insulation displacement slots provide for maximum reliability
- Integral wire strain relief on contact can prevent wire motion from being transmitted to wire termination areas
- Built-in contact post stop can protect terminated wire from being disturbed by over-insertion of mating post, prevents wire from entering contact area and positively limits mating connector depth
- Insulation displacement contacts and crimp, snap-in contacts are interchangeable
- Complete serviceability with replacement contacts
- Cover styles include low profile (polarized, non-polarized, latching and ejection) and standard profile (hermaphroditic and ejection)
- Connector housings may be stacked end-to-end within one pair of covers. All varieties of covers in this catalog are suitable for multiple housing stacking applications similar to the example illustrated in the photograph to the right
- Recognized under the Component Program of Underwriters Laboratories Inc., File No. E28476
- Certified by Canadian Standards Association, File No. LR 7189

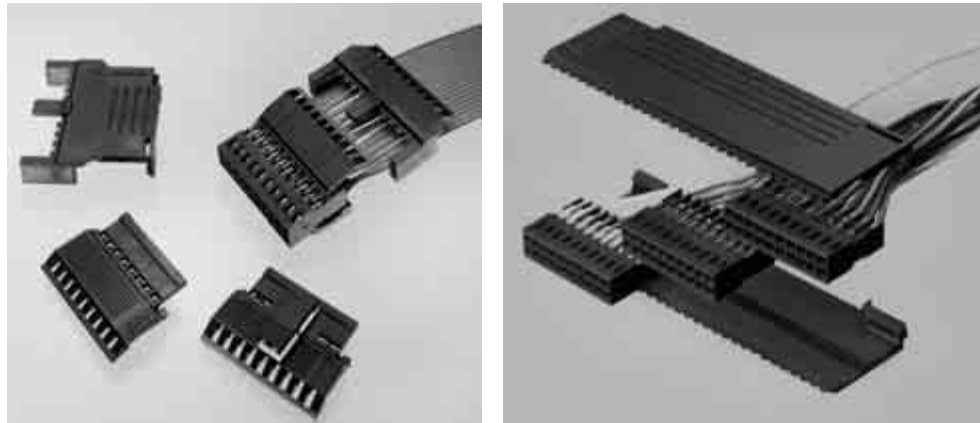

Typical Application of End-to-End Stacking

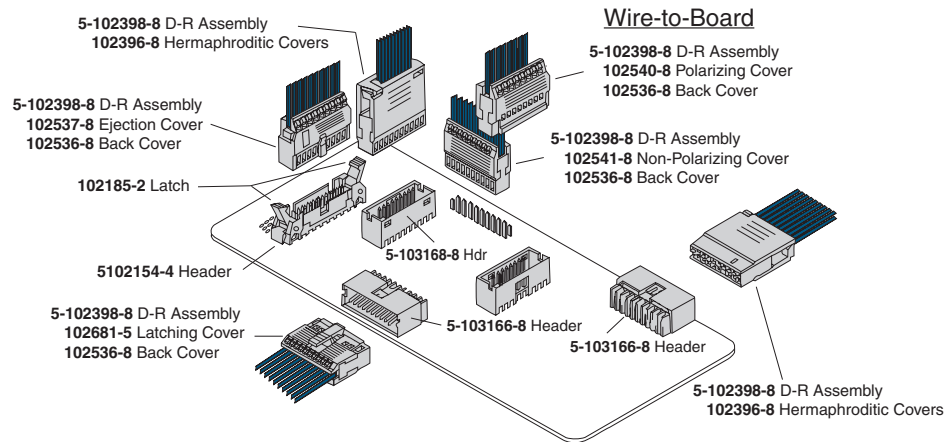

The AMPMODU MT and Shielded MT Interconnection System offers labor and cost savings through mass termination technology, while maintaining the time-proven reliability of the AMPMODU product family. The MT system is comprised of preloaded, double-row receptacle assemblies with snap-on covers and a variety of shielding hardware and accessories. The system is supported by a full line of mass termination tooling to meet virtually most production needs.

The insulation displacement contact, the heart of the MT

system, features a mating interface that is the same as the conventional AMPMODU crimp, snap-in contact, featuring dual cantilever beams, built-in overstress protection and a completely enclosed "box" design.

To reduce EMI/ESD (electromagnetic interference/electrostatic discharge) at the input-output interface, add-on metal shields can be used to convert standard MT connectors to shielded MT connectors.

**Performance Characteristics**

- Contact Current Rating** — 3 amperes for single contact in free air. (Amperage could vary due to ambient temperature, wire size and duty cycles.)
- Operating Temperature** — -65°C to +105°C
- Termination Resistance** — 12 milliohms max.
- Max. Mating Force** — High pressure - 26 oz. [7.23 N] Standard pressure - 9 oz. [2.50 N]
- Min. Unmating Force** — High pressure - 5 oz. [1.39 N] Standard pressure - 1.5 oz. [0.417 N]
- Contact Retention in Housing** — 5 lb. [22.24 N] per contact min.

**Note:** All part numbers are RoHS compliant.

**MT Receptacle Assemblies, Double-Row**  
**.100 x .100 [2.54 x 2.54] Centerline**

**Housings Pre-loaded with Standard Pressure Contacts**



**Material and Finish**

**Housing** — Glass-filled thermoplastic, black, 94V-0 rated

**Contacts** — Copper alloy, duplex plated .000030 [0.00076] gold in mating area, .000050 [0.00127] tin on solder tail, with entire contact underplated .000050 [0.00127] nickel

**Related Product Data**

**Mateable Connectors** — pages 117, 122, 126, 130, 264

**Cable Insulation Wall Thickness** — .015 [0.39] max.

**Cable Insulation Diameter** — .050 [1.27] max.

**Mating Post Length** — .222-.273 [5.64-6.94] max.

**Performance Characteristics** — page 255

**Replacement Contacts** — page 265

**Connector Covers** — pages 258, 259

**Application Tooling** — pages 273-275

**Technical Documents** — pages 277, 278

**Product Specification** 108-25015, 108-25018, 108-25030

**Application Specification** 114-25032

**Instruction Sheet** 408-6532

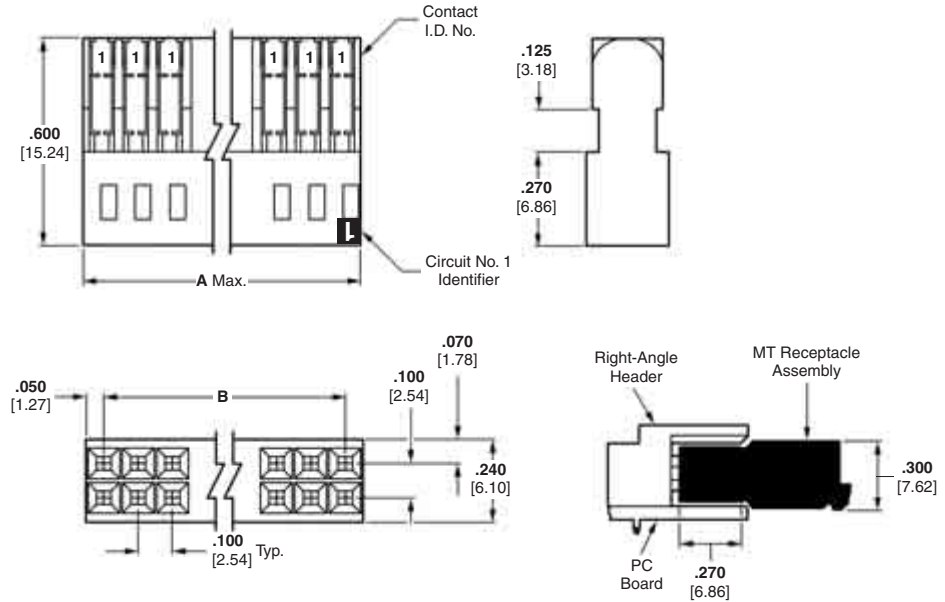

No. of Pos.	Dimensions		Part Nos. (Stamped)			Unloaded Housings
	A	B	Wire Size Range			
			30-26 AWG [0.05-0.15 mm <sup>2</sup> ]	26-22 AWG [0.12-0.3 mm <sup>2</sup> ]	22-20 AWG [0.3-0.6 mm <sup>2</sup> ]	
6	.300 [7.62]	.200 [5.08]	5-102393-1	5-102398-1	5-102448-1	102394-1
8	.400 [10.16]	.300 [7.62]	5-102393-2	5-102398-2	5-102448-2	102394-2
10	.500 [12.70]	.400 [10.16]	5-102393-3	5-102398-3	5-102448-3	102394-3
12	.600 [15.24]	.500 [12.70]	5-102393-4	5-102398-4	5-102448-4	102394-4
14	.700 [17.78]	.600 [15.24]	5-102393-5	5-102398-5	5-102448-5	102394-5
16	.800 [20.32]	.700 [17.78]	5-102393-6	5-102398-6	5-102448-6	102394-6
18	.900 [22.86]	.800 [20.32]	5-102393-7	5-102398-7	5-102448-7	102394-7
20	1.000 [25.40]	.900 [22.86]	5-102393-8	5-102398-8	5-102448-8	102394-8
22	1.100 [27.94]	1.000 [25.40]	5-102393-9	5-102398-9	5-102448-9	102394-9
24	1.200 [30.48]	1.100 [27.94]	6-102393-0	6-102398-0	6-102448-0	1-102394-0
26	1.300 [33.02]	1.200 [30.48]	6-102393-1	6-102398-1	6-102448-1	1-102394-1
28	1.400 [35.56]	1.300 [33.02]	6-102393-2	6-102398-2	6-102448-2	1-102394-2
30	1.500 [38.10]	1.400 [35.56]	6-102393-3	6-102398-3	6-102448-3	1-102394-3
32	1.600 [40.64]	1.500 [38.10]	6-102393-4	6-102398-4	6-102448-4	1-102394-4
34	1.700 [43.18]	1.600 [40.64]	6-102393-5	6-102398-5	6-102448-5	1-102394-5
40	2.000 [50.80]	1.900 [48.26]	6-102393-8	6-102398-8	6-102448-8	1-102394-8
50	2.500 [63.50]	2.400 [60.96]	7-102393-3	7-102398-3	7-102448-3	2-102394-3
60	3.000 [76.20]	2.900 [73.66]	7-102393-8	7-102398-8	7-102448-8	2-102394-8
64	3.200 [81.28]	3.100 [78.74]	8-102393-0	8-102398-0	8-102448-0	3-102394-0

**Note:** Contact Extraction/Lance Reset Tool No. 843477-3, see page 265.

**Keying Plugs**



**Part No. 86286-1**  
(Plugs into receptacle contact)



**Part No. 87077-2**  
(Plugs directly into housing)

**Material** — Natural color nylon

**Note:** All part numbers are RoHS compliant.

**MT Receptacle Assemblies, Double-Row**  
**.100 x .100 [2.54 x 2.54] Centerline** (Continued)

**Housings Pre-loaded with High Pressure Contacts**



**Material and Finish**

**Housing** — Glass-filled thermoplastic, black, 94V-0 rated

**Contacts** — Copper alloy, duplex plated .000030 [0.00076] gold in mating area, .000050 [0.00127] tin on solder tails, with entire contact underplated .000050 [0.00127] nickel

**Related Product Data**

**Mateable Connectors** — pages 117, 122, 126, 130, 264

**Cable Insulation Wall Thickness** — .015 [0.39] max.

**Cable Insulation Diameter** — .050 [1.27] max.

**Mating Post Length** — .200-.273 [5.64-6.94] max.

**Performance Characteristics** — page 255

**Replacement Contacts** — page 265

**Connector Covers** — pages 258, 259

**Application Tooling** — pages 273-275

**Technical Documents** — pages 277, 278

**Product Specification** 108-25015, 108-25018, 108-25030

**Application Specification** 114-25032

**Instruction Sheet** 408-6532

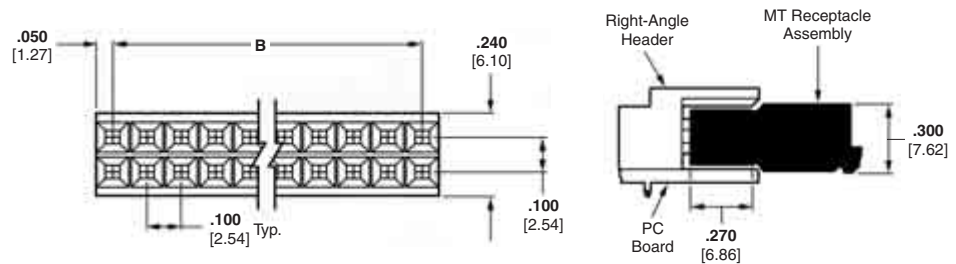

No. of Pos.	Dimensions		Part Nos. (Stamped*)		
	A	B	Wire Size Range		
			30-26 AWG [0.05-0.15 mm <sup>2</sup> ]	26-22 AWG [0.12-0.3 mm <sup>2</sup> ]	22-20 AWG [0.3-0.6 mm <sup>2</sup> ]
6	.300 [7.62]	.200 [5.08]	5-102693-1	5-102694-1	5-102695-1
8	.400 [10.16]	.300 [7.62]	5-102693-2	5-102694-2	5-102695-2
10	.500 [12.70]	.400 [10.16]	5-102693-3	5-102694-3	5-102695-3
12	.600 [15.24]	.500 [12.70]	5-102693-4	5-102694-4	5-102695-4
14	.700 [17.78]	.600 [15.24]	5-102693-5	5-102694-5	5-102695-5
16	.800 [20.32]	.700 [17.78]	5-102693-6	5-102694-6	5-102695-6
18	.900 [22.86]	.800 [20.32]	5-102693-7	5-102694-7	5-102695-7
20	1.000 [25.40]	.900 [22.86]	5-102693-8	5-102694-8	5-102695-8

\*Cavity identification — first cavity (one side); Tyco Electronics Part No. and date code stamped on housing where size permits.  
**Note:** Contact **Extraction/Lance Reset Tool No. 843477-3**, see page 265.

**Keying Plugs**



**Part No. 86286-1**  
(Plugs into receptacle contact)



**Part No. 87077-2**  
(Plugs directly into housing)

**Material** — Natural color nylon

**Note:** All part numbers are RoHS compliant.

**Low Profile Covers for Double-Row MT Receptacle Assemblies**

**Material**

Black thermoplastic, flame retardant

**Related Product Data**

For use on Double-Row MT Receptacle Assemblies — pages 256, 257

**Technical Documents** —  
pages 277, 278

**Product Specification**  
108-25015, 108-25018, 108-25030

**Application Specification**  
114-25032

**Instruction Sheet**  
408-6532

**Note:** See page 259 for Low Profile Cover Part Nos.

**Front Covers**

**A - Polarizing Cover**  
(Mates with AMPMODU 4-sided shrouded headers. Refer to pages 117, 122, 126, 130.)

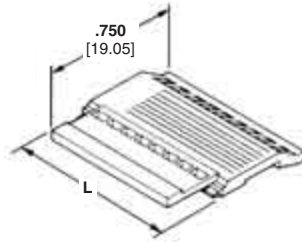

**B - Latching Cover**  
(Mates with AMPMODU 4-sided shrouded headers with extraction slot. Refer to pages 117, 122, 126, 130.)

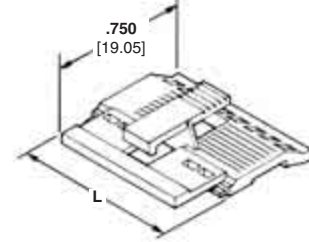

**C - Ejection Cover**  
(Mates with AMP-LATCH universal ejection style pin headers equipped with latching ears, Part No. 102185-2 (with push tabs) or Part No. 102312-2 (without push tabs), see Tyco Electronics Catalog 82012.

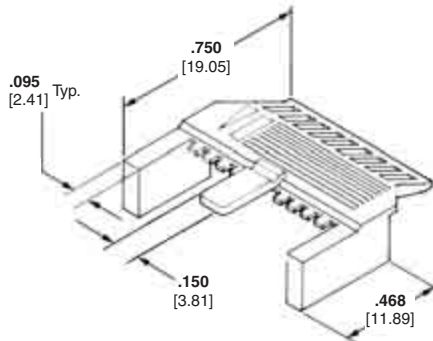

**D - Non-Polarizing Cover**  
(Designed for use with shielded connectors, pages 261 & 262; or for non-polarizing applications.)

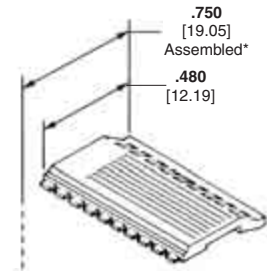

\*Dimension applies to cover when installed on connector housing.

**Back Covers**

**E - For Shielding and Non-Shielding Applications**  
(For use with any low profile cover.)

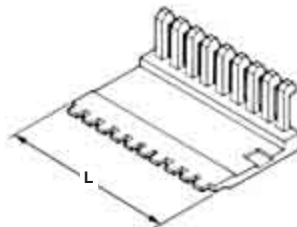

**F - For Shielding Applications**  
(For use with Non-Polarizing Cover only.)

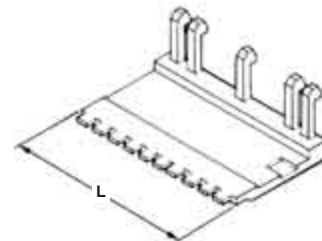

**Note:** All part numbers are RoHS compliant.

## Standard Profile Covers for Double-Row MT Receptacle Assemblies

**Material**

Black thermoplastic, flame retardant

**Related Product Data**

For use on Double-Row MT Receptacle Assemblies — pages 256, 257

**Technical Documents** —  
pages 277, 278

**Product Specification**  
108-25015, 108-25018, 108-25030

**Application Specification**  
114-25032

**Instruction Sheet**  
408-6532

**G - Hermaphroditic Cover**

(Two hermaphroditic covers can be used or one hermaphroditic cover can be used with an H Ejection Cover.)



**H - Ejection Cover**

(Mates with AMP-LATCH universal ejection style pin headers equipped with latching ears, Part No. 102185-2 (with push tabs) or Part No. 102312-2 (without push tabs), see Tyco Electronics Catalog 82012.)

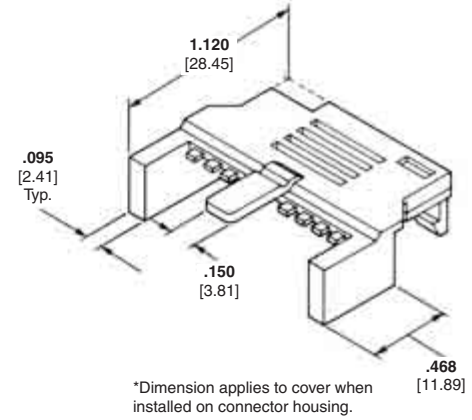

No. of Pos.	Dimension L	Low Profile Covers						Standard Profile Covers	
		Front Covers				Back Covers		G Hermaphroditic	H Ejection
		A Polarizing	B Latching	C Ejection	D Non-Polarizing	E Shielding and Non-Shielding Applications	F Shielding Applications		
6	.300 [7.62]	102540-1	—	102537-1	102541-1	102536-1	—	102396-1	—
8	.400 [10.16]	102540-2	—	102537-2	102541-2	102536-2	—	102396-2	—
10	.500 [12.70]	102540-3	—	102537-3	102541-3	102536-3	—	102396-3	—
12	.600 [15.24]	102540-4	102681-1	102537-4	102541-4	102536-4	102823-5	102396-4	—
14	.700 [17.78]	102540-5	102681-2	102537-5	102541-5	102536-5	102823-6	102396-5	—
16	.800 [20.32]	102540-6	102681-3	102537-6	102541-6	102536-6	102823-7	102396-6	—
18	.900 [22.86]	102540-7	102681-4	102537-7	102541-7	102536-7	102823-1	102396-7	—
20	1.000 [25.40]	102540-8	102681-5	102537-8	102541-8	102536-8	102823-4	102396-8	103268-6
22	1.100 [27.94]	102540-9	102681-6	102537-9	102541-9	102536-9	102823-8	102396-9	—
24	1.200 [30.48]	1-102540-0	102681-7	1-102537-0	1-102541-0	1-102536-0	102823-9	1-102396-0	103268-7
26	1.300 [33.02]	1-102540-1	102681-8	1-102537-1	1-102541-1	1-102536-1	1-102823-0	1-102396-1	103268-8
28	1.400 [35.56]	1-102540-2	102681-9	1-102537-2	1-102541-2	1-102536-2	1-102823-1	1-102396-2	—
30	1.500 [38.10]	1-102540-3	1-102681-0	1-102537-3	1-102541-3	1-102536-3	1-102823-2	1-102396-3	103268-9
32	1.600 [40.64]	—	1-102681-1	1-102537-4	1-102541-4	1-102536-4	1-102823-3	1-102396-4	—
34	1.700 [43.18]	—	1-102681-2	1-102537-5	1-102541-5	1-102536-5	1-102823-4	1-102396-5	1-103268-0
40	2.000 [50.80]	—	1-102681-5	1-102537-8	1-102541-8	1-102536-8	102823-2	1-102396-8	—
50	2.500 [63.50]	—	2-102681-0	2-102537-3	2-102541-3	2-102536-3	102823-3	2-102396-3	1-103268-3
60	3.000 [76.20]	—	—	2-102537-8	2-102541-8	2-102536-8	—	2-102396-8	—
64	3.200 [81.28]	—	—	3-102537-0	3-102541-0	3-102536-0	—	3-102396-0	—

**Note:** All part numbers are RoHS compliant.



## Shielding Hardware and Accessories for MT Interconnection System

### Product Facts

- Add-on shielding accessories for existing AMPMODU Standard MT and PC board mounted headers
- Compact design
- Tin plated copper alloy material
- Redundant cantilever beams provide for good peripheral contact, eliminating the need for a separate RF gasket
- Polarized mating
- 360° cable braid termination with cable jacket support
- Cable shielding hardware permits molded cable terminations after assembly
- Must be used with braided shielded cables
- Solder tabs on right-angle header shields are self-retaining in a PC board



Shielded MT Receptacles

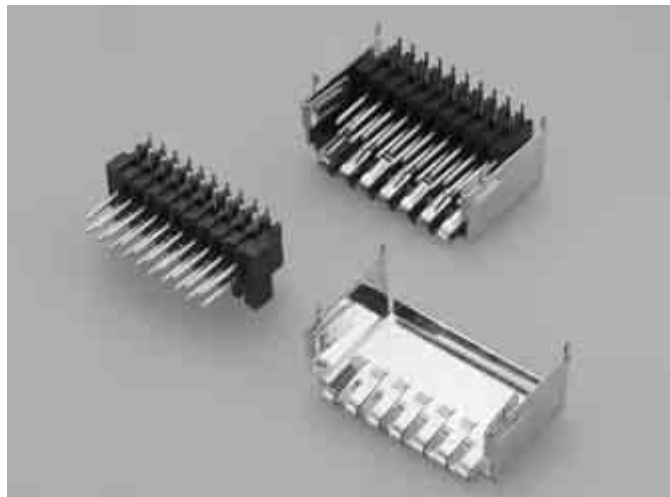

Shielded Right-Angle Headers

The shielded AMPMODU MT system features add-on metal shielding kits for double-row standard MT receptacle assemblies and double-row right-angle headers.

Cable shielding hardware consists of a ferrule and two stamped and formed shell halves. The inner shell half has a series of integral cantilever beams to provide

good peripheral contact with the mating outer shell half. This feature also eliminates the need for a separate RF gasket. Detents in the cantilever beam provide a positive lock when the two halves are mated. During assembly the inner and outer shell halves are snapped together over a terminated standard MT connector.

Shields for right-angle headers have integral cantilever beams which provide good contact with the mating shielded MT receptacle assembly, without the use of a separate RF gasket.



## Shielding Hardware and Accessories for Double-Row MT Receptacle Assemblies

### Two-Piece Shields— Straight Exit

#### Material and Finish

**Shell Halves** — Copper alloy, .020 [0.51] thick; pretinned .000030 [0.00076] min.

#### Related Product Data

**Double-Row MT Receptacle Assemblies** — pages 256, 257

**Non-Polarizing Covers (Part No. Series 102541 with back cover 102536 or 102823)** — pages 258, 259

**Shield Ferrules** — page 263

**Technical Documents** — pages 277, 278

**Product Specification**  
108-25015, 108-25018, 108-25030

**Application Specification**  
114-25032

**Instruction Sheet**  
408-6532



No. of Pos.	Dimensions			Part Nos.	
	A	B	C	Outer Shell	Inner Shell
6	.410 [10.41]	.817 [20.75]	1.268 [32.21]	102988-2	102987-6
10	.610 [15.49]	.817 [20.75]	1.667 [42.34]	103137-2	103136-2
16	.910 [23.11]	.950 [24.13]	1.925 [48.90]	103153-2	103152-2
26	1.410 [35.81]	.950 [24.13]	1.925 [48.90]	103341-2	103340-2
40	2.110 [53.59]	1.325 [33.66]	2.468 [62.69]	104272-1	104271-1
50	2.610 [66.29]	.950 [24.13]	2.468 [62.69]	103158-2	103157-2

**Note:** Match shield size to number of connector positions.

**Note:** All part numbers are RoHS compliant.

## Shielding Hardware and Accessories for Double-Row MT Receptacle Assemblies (Continued)

### Two-Piece Shields— Right-Angle Exit

#### Material and Finish

**Shell Halves** — Copper alloy, .020 [0.51] thick; pretinned .000030 [0.00076] min.

#### Related Product Data

**Double-Row MT Receptacle Assemblies** — pages 256, 257

**Non-Polarizing Covers (Part No. Series 102541 with back cover 102536 or 102823)** — pages 258, 259

**Shield Ferrules** — page 263

**Technical Documents** — pages 277, 278

**Product Specification**  
108-25015, 108-25018, 108-25030

**Application Specification**  
114-25032

**Instruction Sheet**  
408-6532

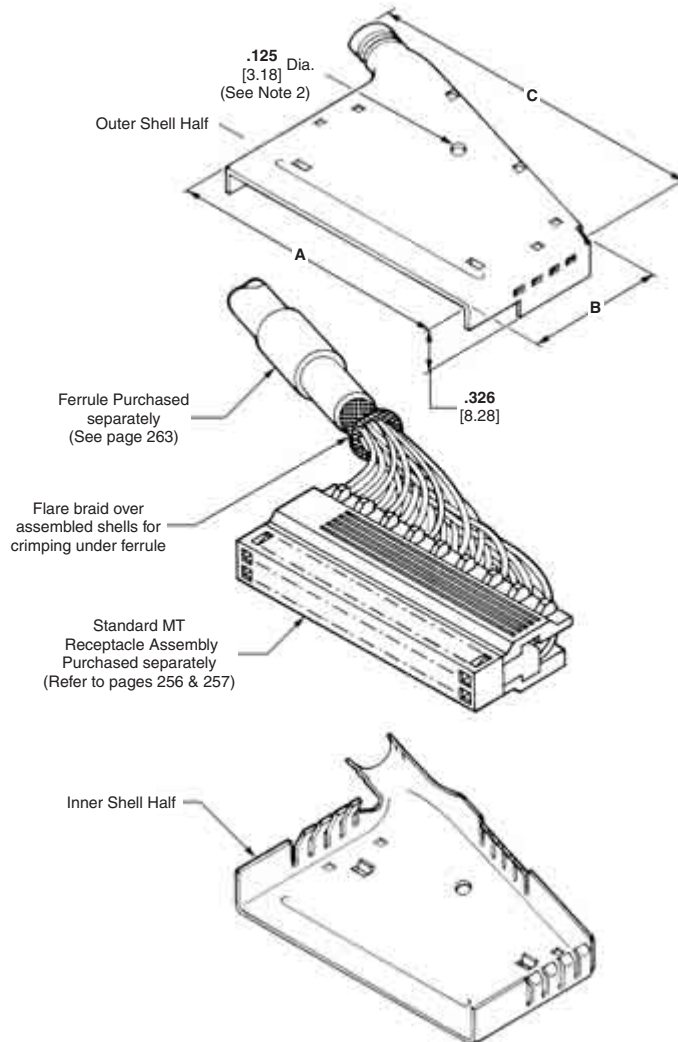

No. of Pos.	Dimensions			Part Nos.	
	A	B	C	Outer Shell	Inner Shell
18	1.010 [25.65]	1.120 [28.45]	1.413 [35.89]	102784-2	102783-2
26	1.410 [35.81]	1.166 [29.62]	1.975 [50.17]	103139-2	103138-2
40	2.110 [53.59]	1.135 [28.83]	2.633 [66.88]	102786-2	102785-2
50	2.610 [66.29]	.983 [24.97]	3.133 [79.58]	102788-2	102787-2
60	3.110 [78.99]	1.118 [28.40]	3.606 [91.59]	103141-2	103140-2

**Notes:** 1. Match shield size to number of connector positions.  
2. Hole is provided in 26 through 60-position cable shields for application of optional cable tie pull ring after assembly.

**Note:** All part numbers are RoHS compliant.

## Shielding Hardware and Accessories for Double-Row MT Receptacle Assemblies (Continued)

### Ferrules for Shielding Kits

#### Material and Finish

Soft copper, tin plated

#### Related Product Data

**Used with Shielding Kits** —  
pages 261, 262

#### Technical Documents

pages 277, 278

#### Product Specification

108-25015, 108-25018, 108-25030

#### Application Specification

114-25032

#### Instruction Sheet

408-6532



#### Application Tooling



**AMP-O-LECTRIC Model  
"G" Terminating Machine**



**Tyco Electronics Hand Tool 91410-1  
(Die Set required, see table below)**

No. of Pos.	Straight-Exit Shields		Right-Angle Exit Shields		Cable Dia. Range	Ferrule Part Number	Applicator Die* Assembly Part No.	Hand Tool Die Sets	
	Outer	Inner	Outer	Inner				Insulation	Braid
6	102988-2	102987-6	—	—	0.200-0.250 [5.08-6.35]	102985-4	812665-2	1-527116-8	527116-4
					0.250-0.300 [6.35-7.62]	5-102903-2	812665-5	1-527116-6	527116-3
					0.310-0.360 [7.87-9.14]	5-102903-1	812665-3	1-527116-5	527116-3
10	103137-2	103136-2	—	—	0.370-0.420 [9.40-10.67]	5-102789-1	812665-3	1-527116-4	527116-3
					0.190-0.240 [4.83-6.10]	5-102903-3	812665-6	1-527116-7	527116-3
					0.250-0.300 [6.35-7.62]	5-102903-2	812665-5	1-527116-6	527116-3
16	103153-2	103152-2	—	—	0.310-0.360 [7.87-9.14]	5-102903-1	812665-4	1-527116-5	527116-3
					0.370-0.420 [9.40-10.67]	5-102789-1	812665-3	1-527116-4	527116-3
					0.190-0.240 [4.83-6.10]	5-102903-3	812665-6	1-527116-7	527116-3
18	—	—	102784-2	102783-2	0.250-0.300 [6.35-7.62]	5-102903-2	812665-5	1-527116-6	527116-3
					0.310-0.360 [7.87-9.14]	5-102903-1	812665-4	1-527116-5	527116-3
					0.370-0.420 [9.40-10.67]	5-102903-1	812665-3	1-527116-4	527116-3
26	103341-2	103340-2	103139-2	103138-2	0.320-0.370 [8.13-9.40]	5-102903-4	812665-9	1-527116-3	527116-2
					0.430-0.460 [10.92-11.68]	5-102789-2	812665-7	1-527116-1	527116-2
					0.320-0.370 [8.13-9.40]	5-102903-4	812665-9	1-527116-3	527116-2
40	104272-1	104271-1	102786-2	102785-2	0.430-0.460 [10.92-11.68]	5-102789-2	812665-7	1-527116-1	527116-2
					0.380-0.420 [9.65-10.67]	5-102903-6	1-812665-5	1-527116-2	527116-1
					0.430-0.460 [10.92-11.68]	5-102903-5	1-812665-4	1-527116-1	527116-1
50	103158-2	103157-2	102788-2	102787-2	0.470-0.520 [11.94-13.21]	5-102789-3	1-812665-3	1-527116-0	527116-1
					0.470-0.520 [11.94-13.21]	5-102903-8	1-812665-8	—	—
					0.500-0.545 [12.70-13.84]	5-102903-7	1-812665-7	—	—
60	—	—	103141-2	103140-2	0.550-0.600 [13.97-15.24]	5-102789-4	1-812665-6	—	—
					—	—	—	—	—

\*For use with Model "K" machines. Call the Tyco Electronics Technical Support Center (1-800-522-6752) for part nos. of applicators for use with the AMP-O-LECTRIC Model "G" machines (also shown on page 270), as well as other bench machines and fully automatic AMPOMATOR lead making machines.

- Notes:** 1. Ferrules are used with shielding kits shown on pages 261 & 262, and are purchased separately.  
2. Individual anvils and crimpers also may be purchased separately.  
3. Ferrule Part Number 1-102903-8 also requires Spacer Part Number 527116-9.

**Note:** All part numbers are RoHS compliant.

**Shielded MT Headers for use with Shielded MT Receptacle Assemblies**

**AMPMODU Right-Angle Headers PC Board Mounted**

**Material and Finish**

**Housing** — Black thermoplastic, flame retardant

**Posts** — Copper alloy, plated .000030 [0.00076] gold over .000050 [0.00127] nickel on entire post

**Shield** — Copper alloy, .020 [0.51] thick; pretinned .000030 [0.00076] min.

**Related Product Data**

**Mating Connectors** — Double-Row MT Receptacle Assemblies with Shielding Hardware — pages 256-263

**Technical Documents** — pages 277, 278

**Product Specification** 108-25015, 108-25018, 108-25030

**Application Specification** 114-25032.

**Instruction Sheet** 408-6532

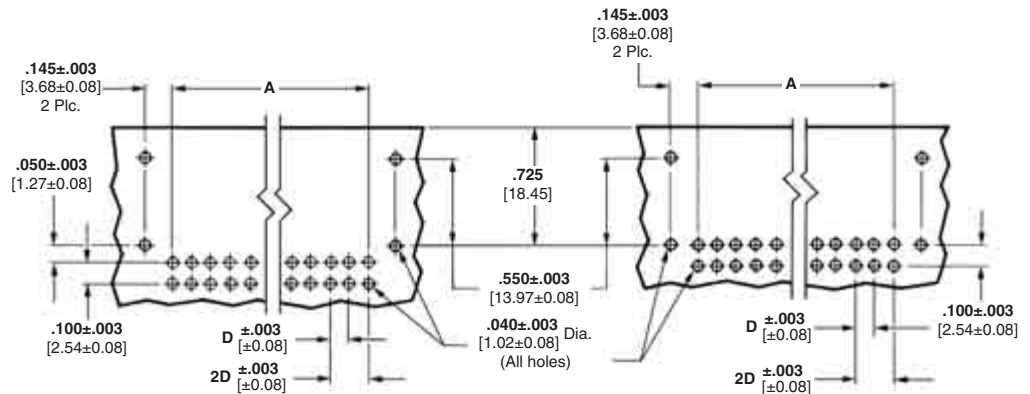

**Recommended PC Board Hole Layout for 6, 8 and 10 Positions**

**Recommended PC Board Hole Layout for 16 thru 50 Positions**

D - Contact centerline is .100 [2.54]; ±.003 [0.08] tolerances not to accumulate within one connector pattern.

No. of Pos.	Dimensions			Header Part Nos.	Shield Part Nos.
	A	B	C		
6	.200 [5.08]	.430 [10.92]	.510 [12.95]	102792-6	102991-1
8	.300 [7.62]	.530 [13.46]	.610 [15.49]	102792-8	102991-2
10	.400 [10.16]	.630 [16.00]	.710 [18.03]	102792-1	102791-2
16	.700 [17.78]	.930 [23.62]	1.010 [25.65]	102792-7	102791-3
18	.800 [20.32]	1.030 [26.16]	1.110 [28.19]	102792-2	102791-4
20	.900 [22.86]	1.130 [28.70]	1.210 [30.73]	102792-5	1-102791-0
26	1.200 [30.48]	1.430 [36.32]	1.510 [38.35]	102792-9	102791-1
50	2.400 [60.96]	2.630 [66.80]	2.710 [68.83]	102792-4	102791-8

**Note:** All part numbers are RoHS compliant.

## Replacement MT Receptacle Contacts

### Insulation Displacement Contacts

#### Material and Finish

Copper alloy, duplex plated .000030 [0.00076] gold in mating area, .000100-.000200 [0.00254-0.00508] tin in crimp area, with entire contact underplated .000050 [0.00127] nickel



#### Related Product Data

**Performance Characteristics** — page 255

**Application Tooling** — pages 273-275

**Technical Documents** — pages 277, 278

**Product Specification** 108-25015, 108-25018, 108-25030

**Application Specification** 114-25032

**Instruction Sheet** 408-6532

Wire Size Range		Standard Pressure Receptacle		High Pressure Receptacle	
AWG	[mm <sup>2</sup> ]	Contact Ident.	Part No.	Contact Ident.	Part No.
30-26	0.05-0.15	1	5-102395-2	4	5-102641-6
26-22	0.12-0.3	2	5-102399-1	5	5-102642-6
22-20	0.3-0.6	3	5-102449-6	—	—

**Note:** Termination tooling for MT receptacle insulation displacement contacts is shown on pages 273-275.

MT receptacle contacts incorporate the following features.



The MT receptacle contact cross-section is primarily rectangular, with rounded corners. Two integral cantilever beams contact the mating square male posts. Deflection of these spring members is limited by anti-overstress and excessive permanent deformation is prevented. This feature allows a wide range for tolerance of misalignment of mating contacts.

The configuration of the receptacle completely encloses the spring members helping to prevent damage during handling and assembly, and makes the system compatible with automatic application techniques.





**Extraction/Lance Reset Tool No. 843477-3**

**Note:** All part numbers are RoHS compliant.



## Mini-Tandem Spring Receptacle Housings and Contacts

### Product Facts

- Individual contacts mate with .025 [0.64] sq. posts, .125 [3.18] long
- Crimp snap-in contacts accept 32-22 AWG [0.03-0.32 mm<sup>2</sup>] wire
- Retention latch provides for positive installation
- No insertion tool required
- High durability design provides long life
- Available with .000015 [0.00038] or .000030 [0.00076] thick gold inlay in contact areas, or bright tin plated
- Closed-entry housings
- Mini-contact box size: .060 [1.52] sq.
- Mini-Tandem Spring Housings can be stacked on .100 [2.54] centers in either direction
- Mini-Tandem Spring Housings are Recognized under the Component Program of Underwriters Laboratories Inc.,  File No. E28476
- Certified by Canadian Standards Association,  File No. LR 7189

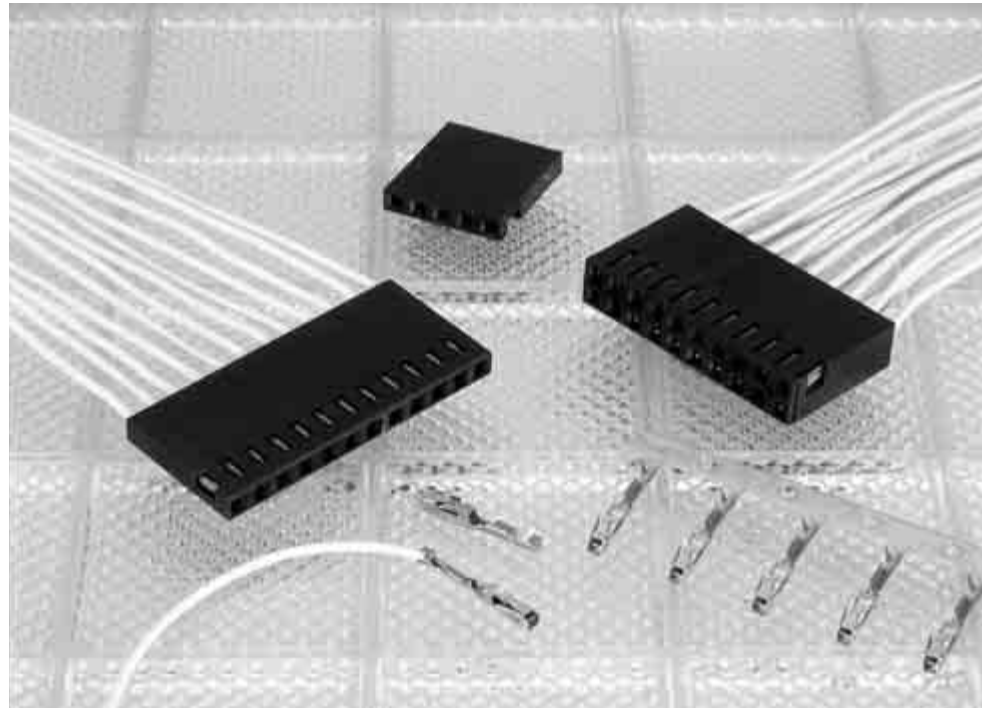

Mini-Tandem Spring Receptacle Contacts are designed to mate with .025 [0.64] posts. When used individually, they will mate with posts as short as .125 [3.18] and when used in a housing, they will mate with .140 [3.55] long posts. These versatile contacts may be used for interconnecting posted pc panels, I/O wiring and cross-connecting pin arrays.

The receptacle contact's box configuration provides for long contact life with controlled contact mating forces which minimize wear. An external retention spring facilitates quick assembly and provides firm seating in a contact housing.

Mini-Tandem Spring Receptacle Contacts are used in single- or double-row housings with .100 [2.54] centerline spacing. Single-row housings can be converted into double-row connectors on .100 x .200 [2.54 x 5.08] centers with the use of stacking clips.

Mini-Tandem Spring Housings can be stacked side-by-side or end-to-end on .100 [2.54] centers.

### Specifications

**Contact Current Rating** — 3 amperes

**Termination Resistance** — 12 milliohms (max.) — gold plated contacts  
18 milliohms (max.) — tin plated contacts

**Durability** — Ref. Product Specification 108-25031



**Mini-Tandem Spring Housings, Single-Row**

**.100 [2.54] Centerline**



**Material** — Black glass-filled polyester, 94V-0 rated

**Technical Documents** — pages 277, 278

**Product Specification**  
108-25031

**Application Specification**  
114-25021

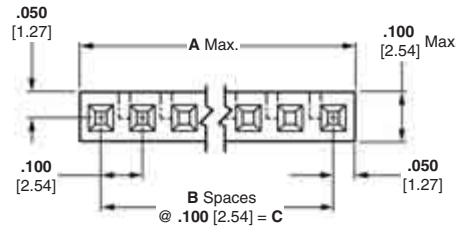
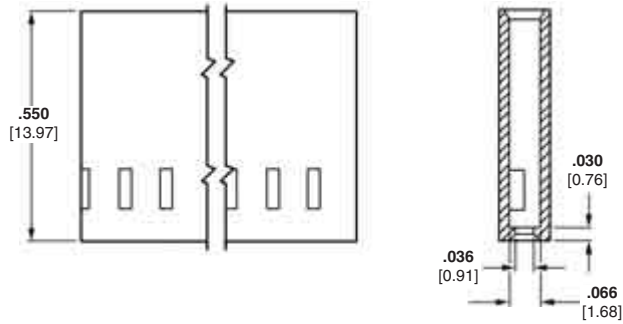

Minimum mating post length is .140 [3.55].

**Material**—Natural color nylon, 94V-2 rated



**Keying Plug**  
**Part No. 531226-1**  
(Plugs directly into housing)

**Note:** Mini-Tandem Spring contacts for use in these housings are shown on page 269.

No. of Pos.	Dimensions			Housing Part No.
	A	B	C	
2	.200 [5.08]	1	.100 [2.54]	530554-1
4	.400 [10.16]	3	.300 [7.62]	530554-3
8	.800 [20.32]	7	.700 [17.78]	530554-7
12	1.200 [30.48]	11	1.100 [27.94]	1-530554-1
16	1.600 [40.64]	15	1.500 [38.10]	1-530554-5
18	1.800 [45.72]	17	1.700 [43.18]	1-530554-7
20	2.000 [50.80]	19	1.900 [48.26]	1-530554-9
22	2.200 [55.88]	21	2.100 [53.34]	2-530554-1

**Note:** All part numbers are RoHS compliant.

**Mini-Tandem Spring Housings, Double-Row**

**.100 [2.54] Centerline**



**Material** — Black glass-filled polyester, 94V-0 rated\*

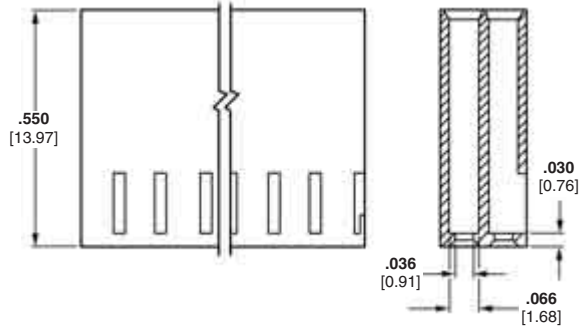

**Technical Documents** —  
pages 277, 278

**Product Specification**  
108-25031

**Application Specification**  
114-25021

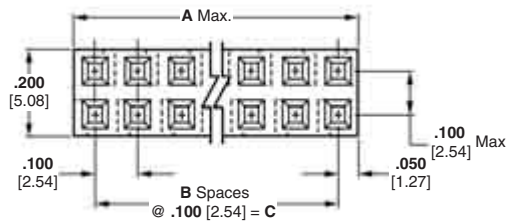

Minimum mating post length is .140 [3.55].

Mini-Tandem  
Spring Contacts

5

**Material** — Natural color nylon,  
94V-2 rated



**Keying Plug**  
**Part No. 531226-1**  
(Plugs directly into housing)

No. of Pos.	Dimensions			Housing Part No.
	A	B	C	
6	.300 [7.62]	2	.200 [5.08]	530902-1
8	.400 [10.16]	3	.300 [7.62]	530902-6
12	.600 [15.24]	5	.500 [12.70]	2-530902-0
16	.800 [20.32]	7	.700 [17.78]	3-530902-0

**Note:** Mini-Tandem Spring contacts for use in these housings are shown on page 269.

\*Consult Tyco Electronics for specific UL recognition.

**Note:** All part numbers are RoHS compliant.

## Mini-Tandem Spring Contacts

### Receptacle Contacts

#### Material and Finish

Phosphor bronze, plated as follows:

**Plating A** — Duplex plated .000030 [0.00076] gold inlay on contact area, matte tin in crimp area, with entire contact underplated .000050 [0.00127] nickel

**Plating B** — Duplex plated .000015 [0.00038] gold inlay on contact area, matte tin in crimp area, with entire contact underplated .000050 [0.00127] nickel

**Plating C** — Duplex plated .000050 [0.00127] over matte tin in contact area, over .000030 [0.00076] nickel on entire contact

**Plating D** — .000100 [0.00254] min. matte tin over .000030 [0.00076] nickel on entire contact

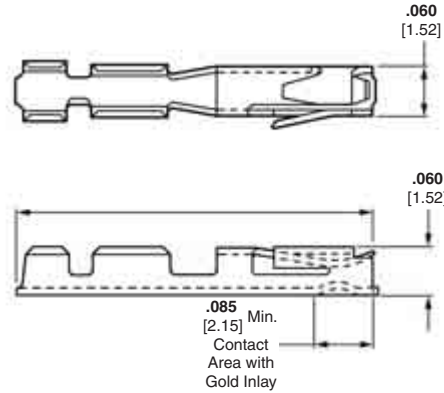

#### Technical Documents — pages 277, 278

**Product Specification**  
108-25031

**Application Specification**  
114-25021

#### Low Pressure Contacts

Wire Size Range AWG	mm <sup>2</sup>	Ins. Dia. Range	Finish	Contact Part No.		Miniature Applicator for AMP-O-LECTRIC Machine*	Applicator for AMP-O-MATIC Stripper/Crimper Machine
				Strip Form	Loose Piece		
26-22	0.14-0.32	.036-.054 [0.64-1.37]	Plating A	5531216-3	5531216-4	466819-2	466943-1
			Plating B	5531216-1	5531216-2		

#### Standard Pressure Contacts

Wire Size Range AWG	mm <sup>2</sup>	Ins. Dia. Range	Finish	Contact Part No.		Miniature Applicator for AMP-O-LECTRIC Machine*	Applicator for AMP-O-MATIC Stripper/Crimper Machine
				Strip Form	Loose Piece		
32-28	0.03-0.08	.025-.054 [0.64-1.37]	Plating B	530901-2	530901-3	466723-1	466952-1
			Plating C	5530901-6	5530901-7		
			Plating D	5530901-4	5530901-5		
26-22	0.14-0.32	.036-.054 [0.91-1.37]	Plating B	5530553-4	—	466819-2	466943-1
			Plating C	5530553-6	—		
			Plating D	5530553-2	—		

#### High Pressure Contacts

Wire Size Range AWG	mm <sup>2</sup>	Ins. Dia. Range	Finish	Contact Part No.		Miniature Applicator for AMP-O-LECTRIC Machine*	Applicator for AMP-O-MATIC Stripper/Crimper Machine
				Strip Form	Loose Piece		
32-28	0.03-0.08	.025-.054 [0.64-1.37]	Plating B	5531225-6	—	466723-1	466952-1
26-22	0.14-0.32	.036-.054 [0.91-1.37]	Plating B	5531224-6	—	466819-2	466943-1

\*For use with AMP-O-LECTRIC Model "K" machines. Call the Tooling/Technical Assistance Center (1-800-522-6752) for part nos. of applicators for use with the AMP-O-LECTRIC Model "G" machines (shown on page 270), as well as other bench machines and fully automatic AMPOMATOR lead making machines.

- Notes:**
1. Mini-Tandem Spring Receptacle Contacts are for use only in the housings shown on pages 267 & 268. They cannot be used in AMPMODU Mod IV Housings.
  2. Use Hand Tool No. 91540-1 for crimping loose-piece receptacles to all wire sizes listed above.
  3. Application tooling is described on pages 270 & 275.

**Note:** All part numbers are RoHS compliant.

## Application Tooling for Wire Crimp Contacts

Tooling shown on this page is designed to terminate wire crimp contacts used in various AMPMODU wire-to-board connectors. Refer to page 88 to determine the applicable connectors.

### AMP-O-LECTRIC Model "G" Terminating Machine (Shown with Optional Crimp Force Monitor)

A totally new design of our most popular machine for bench-top operation. It features a quiet and reliable direct motor drive, electronic controls for easy setup and operation, and improved guarding and lighting for operator convenience and safety. All versions include either manual or automatic precision adjustment for crimp height.

For further details, request Tyco Electronics Catalog 65828.



### AMP-O-MATIC Stripper/Crimper Machine

#### Applicators

Several terminating machines, including the AMP-O-LECTRIC Model "G", AMP-O-MATIC Stripper/Crimper and AMPOMATOR CLS machines, are designed for use with interchangeable applicators. Basic styles are quickly interchangeable to minimize costly downtimes, and feature dial-in wire and insulation crimp height settings. Special applicators are available for use with the Crimp Force Monitor (see page 272), for measuring the crimp height of each termination as it is made, plus evaluating the quality of each crimp.



This machine automatically strips as well as terminates individual wires. Similar to the AMP-O-LECTRIC Model "G" machine, applicators are quickly interchangeable, and it includes precision adjustment for crimp height. All adjustments can be made from the front of the machine, without special tools.

For further details, request Tyco Electronics Catalog 65004.



#### Heavy Duty Miniature Applicators



#### EDGE, Electronic Applicator Counter

The new versatile EDGE applicator counter tracks wearable tool usage for the most effective maintenance planning. The completely electronic counter with clear LCD display, indicates cycles since installation. By performing maintenance at measured intervals with pre-set limits, operators avoid breakdowns and rejects caused by tool wear or mid-adjustment. For more information, request catalog 1773385.

**Application Tooling for Wire Crimp Contacts** (Continued)

**AMP 3K/40 and AMP 5K/40 Terminators**

As a value oriented terminator, the AMP 3K/40 and AMP 5K/40 are designed for customers that require the increased output and quality of a semiautomatic machine at a competitive price. By incorporating the most commonly requested features as standard and offering a long list of optional equipment, these terminators offer flexibility to meet the specific needs of various applications at the lowest possible cost.



**AMP 5K/40 Terminator**

**Optional Stripping Module for the AMP 3K/40, AMP 5K/40 and the AMP-O-LECTRIC Model G**

The combination of the Stripping Module with the AMP-O-LECTRIC Model G Terminator or the AMP 3K/40, 5K/40 provides an economical, proficient method of stripping wire and crimping terminals on the same machine. Wires are stripped moments before crimping, meaning there is virtually no chance of damaging wire conductors during handling or storage. Once the wire is fed into the start sensor, the Stripping Module does the rest, improving placement accuracy. For more information, request catalog 1309085.

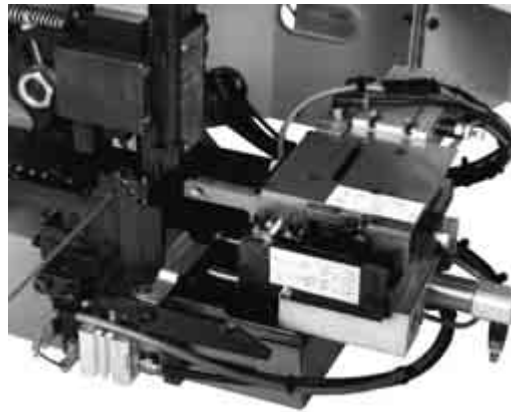

**Application Tooling for Wire Crimp Contacts** (Continued)

Tooling shown on this page is designed to terminate wire crimp contacts used in various AMPMODU wire-to-board connectors. Refer to page 88 to determine the applicable connectors.

**Crimp Force Monitor (CFM)**



Your quality program calls for more than a good crimping system. It demands proof - the proof you get with the SLE Crimp Force Monitor. It has high-resolution piezo-quartz sensor technology for a more precise identification of typical crimping faults. The monitor features Zone & Peak Force Analysis, 128x128 Dot Matrix, Force Trigger and Encoder Proximity Trigger, and Absolute Force Measurement for real-time monitoring of every crimp. The CFM can be used with bench or fully-automatic machines. Special applicators are not required.

Sure, you can sample and test crimp height with a micrometer. In fact, that's how you standardize your process. But for ongoing quality control, testing every crimp, SLE is the choice. It's known worldwide, and meets our standards for a high performance terminating system. That's how you can be sure.

High quality crimping - with verification - means higher production and productivity.

**AMPOMATOR System III Leadmaker**



The AMPOMATOR System III is an automatic machine for the production of terminated wire leads. The machine combines state of the art technology to process single and double wire application utilizing the wire processing industry's best and most friendly subsystems and accessories available to meet the latest market requirements for wire lead production.

The new machine incorporates a servo-driven, software-controlled AMP-O-LECTRIC ST III terminator and the next generation System III Applicator.

See catalog 1654956-5 for more information.



**Commercial PRO-CRIMPER III Hand Tool**



Commercial grade hand tool for crimping various products. Features ratchet control to provide complete crimp cycle. Accepts both pinned- and shouldered-style die sets. Locators are provided with pinned-style die sets for proper contact and wire positioning, and to help minimize contact rotation and bending during crimping. Approximate weight 1.3 lb [0.60 kg].

**Premium CERTI-CRIMP Straight Action Hand Tool (SAHT)**



Tyco Electronics hand tools are ideal for small production and prototype applications. They feature ratchet control to help eliminate partial crimps, straight-line die closure, terminal

locator and support, and insulation crimp adjustment. Tyco Electronics hand tools also can be adapted for use with pneumatic tooling assemblies, providing air operated crimping capabilities.

For further details on Tyco Electronics straight action hand tools, request Tyco Electronics Catalog 65780. For more details on Tyco Electronics pneumatic tooling assemblies, call the Tyco Electronics Technical Support Center, 1-800-522-6752.



Application Tooling

5



## Application Tooling for Insulation Displacement Crimp (IDC) Contacts and Connectors

Tooling shown on this page is designed to terminate IDC contacts for various AMPMODU wire-to-board connectors. Refer to page 88 to determine the applicable connectors.

### Pistol Grip Manual and Air Powered Tools

The manual pistol grip tool features an interchangeable modular terminating head which also can be used in the pneumatic version, the Bench Mount Pneumatic Power Assembly and the IDC Electric Power Unit. The head terminates one unstripped wire per cycle and indexes the connector to the next terminating position. The head rotates to permit optimum access to the wiring area.

The Bench Mount Pneumatic Power Assembly is air actuated with either a foot or knee switch. This capability frees the operator's hands for optimum positioning.

#### Modular Heads:

- 58062-1** (for MT connectors)
- 58336-1** (for MTE connectors)
- 58395-1** (for Level V IDC connectors)
- 58540-1** (for MTE connectors, discrete wire or flat ribbon cable)



**Manual Pistol Grip  
Tool No. 58074-1**



**Pneumatic Pistol Grip  
Tool No. 58075-1**



**Bench Mounted Pneumatic Power Assembly  
No. 58338-1**

### Modular Head Tool No. 58540-1



This modular head tool can be used on any pistol grip tool. It was designed for discrete wire or flat ribbon cable applications.

**Note:** All part numbers are RoHS compliant.



**IDC Electric Power Unit  
No. 931800-1**

### IDC Electric Power Unit

This electrically powered semiautomatic bench machine is designed for applying AMPMODU MTE and MT connectors to discrete wires. It is portable and compact and uses existing pistol grip modular heads. The heads are easily interchanged to run different products. \*The IDC Electric Power Unit's cycle rate is approximately 7,200 cycles per hour, with exact production rates depending upon operator dexterity.

#### Modular Heads:

- 58062-1** (for MT connectors)
- 58336-1** (for MTE connectors)

\*A tube-fed track assembly, Part No. 856675-1, also can be used with MTE Connectors.

**Application Tooling for Insulation Displacement Crimp (IDC) Contacts and Connectors** (Continued)

Tooling shown on this page is designed to terminate IDC contacts for various AMPMODU wire-to-board connectors. Refer to page 88 to determine the applicable connectors.

**Tube-Fed Ribbon Cable Machine**



**Tube-Fed Ribbon Cable Machine No. 856002-1**

Designed for bench applications, this machine is pneumatically operated and controlled by a foot pedal. It terminates connectors onto end-notched ribbon cable. \*The connectors are supplied in strip form and in plastic tubes. The machine consists of three basic sub-assemblies: a feed track, a terminating station and a seating station. The feed track is a constant force,

spring-driven unit which conveys connectors through the product tube to the terminating station. The air-operated terminating station positions and terminates contacts onto the notched cable. The seating station is manually operated and seats connector housings onto the terminated contacts.

\*At a rate of 13-25 positions at a time.

**2700 lb. Power Unit With Cable Notching Die**



**2700 lb. Power Unit No. 312522-1**

Equipped with a cable notching die an adapter kit, this fully pneumatic bench machine provides the 2700 lb [12 010N] force required for end-notching ribbon cable. It features a grooved cable support plate, a pressure plate and a cable stop to facilitate cable alignment and positioning during the notching process.

**Notching Dies:**

**854449-1** (for 24-22 AWG [0.2-0.6 mm<sup>2</sup>] Wire)

**854449-2** (for 28-26 AWG [0.08-0.15 mm<sup>2</sup>] Wire)

**Note:** All part numbers are RoHS compliant.

**Application Tooling for Insulation Displacement Crimp (IDC) Contacts and Connectors** (Continued)

Tooling shown on this page is designed to terminate IDC contacts for various AMPMODU wire-to-board connectors. Refer to page 88 to determine the applicable connectors.

**CHAMPOMATOR Model 2.5 Terminating Machine No. 354786-(\*)**



This compact bench machine terminates wires manually sorted from multiconductor cables. Termination sequence may include full termination of all contacts, or selective termination. Designed for easy programming, the machine is microprocessor controlled

and programmed by a membrane switch keyboard. It also has an internal storage capability for retaining up to 350 cable assemblies. Connectors can be terminated with either straight or right-angle wire dress.

\*For applicable dash nos., call the Technical Support Center: 1-800-522-6752. For further details, request Tyco Electronics Catalog 82247

**CHAMPOMATOR Model 3A Terminating Machine No. 761420-(\*)**



This floor model machine automatically sorts wires from multiconductor jacketed cable and terminates them in a user-determined sequence; either full termination of all contacts, or selective termination. Designed for easy programming, the machine is microprocessor

controlled and programmed by a touchscreen. It also has an internal storage capability for retaining up to 50 cable assemblies. Connectors can be terminated with either straight or right-angle wire dress. All cable assemblies are tested for continuity and shorts.

\*For applicable dash nos., call the Technical Support Center: 1-800-522-6752. For further details, request Tyco Electronics Catalog 82247

**Note:** All part numbers are RoHS compliant.

## Technical Documents for Board-to-Board Products

Various technical documents are available for your use.

**Product Specifications** describe technical performance characteristics and verification tests. They are intended for the Design, Component and Quality Engineers.

**PC/104 and PC/104-Plus Connectors — Pages 5-12:**

108-1956 PC/104 and PC/104-Plus Connector Systems

**Receptacle Assemblies and Unshrouded Breakaway Headers, Surface-Mount — Pages 109, 110, 185-192:**

108-25017 AMPMODU Interconnection System, Two-Piece

108-25022 AMPMODU Mod. IV Interconnection System, Vertical Assemblies

108-25026 AMPMODU Mod. II Interconnection System, Standard Pressure Receptacle Assembly and Header

**Two-Piece Printed Circuit Board Connectors — Pages 193-202:**

108-16 ACTION PIN Contacts

108-25017 AMPMODU Interconnection System, Two-Piece

108-25027 AMPMODU Mod. II Interconnection System, Short-Point Receptacle Assembly and Header

**Receptacle Assemblies, Horizontal and Vertical Board Mount — Pages 168-192:**

108-25022 AMPMODU Mod. IV Interconnection System, Vertical Assemblies

108-25026 AMPMODU Mod. II Interconnection System, Standard Pressure Receptacle Assembly and Header

108-25027 AMPMODU Mod. II Interconnection System, Short-Point Receptacle Assembly and Header

**.025 [0.64] Square Posts, Headers, Accessories and Tooling — Pages 92-105, 114-140, 145-153, 163:**

108-16 ACTION PIN Contacts

108-25026 AMPMODU Mod. II Interconnection System, Standard Pressure Receptacle Assembly and Header

**Application Specifications** describe requirements for using the product in its intended application, and/or crimping information. They are intended for the Packaging and Design Engineers and the Setup person.

**PC/104 and PC/104-Plus Connectors — Pages 5-12:**

114-13021 PC/104 and PC/104-Plus Connectors

**Two-Piece Printed Circuit Board Connectors — Pages 193-202:**

114-9009 AMPMODU Header, Two-Piece, Double Row, Application of

**Receptacle Assemblies, Horizontal and Vertical Board Mount — Pages 168-192:**

114-25018 AMPMODU Mod. II and IV Receptacle Assembly, PC Board Mounted, Vertical, Application of

**.025 [0.64] Square Posts, Headers, Accessories and Tooling — Pages 92-105, 114-140, 145-153, 163-167:**

114-25028 ACTION PIN Contacts with Tyco Electronics Headers, Application

114-13011 AMPMODU .025 and .045 Square Continuous Posts

**Instruction Sheets** provide instructions for assembling or applying the product. They are intended for the Manufacturing Assembler or Operator.

**PC/104 and PC/104-Plus Connectors — Pages 5-12:**

408-8502 Future Board Assembly 1424685 for PC/104 and PC/104-Plus Connectors

408-8503 Seating Tool Assembly 1424686 for PC/104 and PC/104-Plus Connectors

408-8504 Pneumatic Seating Tool Assembly 1424930-1 for PC/104 and PC/104-Plus Connectors

408-8505 Manual Seating Tool Assembly 1424931-1 for PC/104 and PC/104-Plus Connectors

**Two-Piece Printed Circuit Board Connectors — Pages 193-202:**

408-2636 ACTION PIN Contact Rear Insertion/Extraction Tool 265871-7

408-9054 Seating Tools

**Receptacle Assemblies, Horizontal and Vertical Board Mount — Pages 168-192:**

408-7411 Suggestions for Wave Soldering Vertical AMPMODU Receptacles

**.025 [0.64] Square Posts, Headers, Accessories and Tooling — Pages 92-105, 114-140, 145-153, 163:**

408-2636 ACTION PIN Contact Rear Insertion/Extraction Tool 265871-7

408-6944 Tyco Electronics Uninsulated Bandolier Post Insertion Tool 91419-1

408-7977 AMPMODU Double Row, Straight Posts, End Shrouds .100 x .100 [0.64 x 0.64] Centers

408-7878 AMPMODU Header Barrier Inserts

408-9054 ACTION PIN Contact Headers Seating Tool, 91170 Series

408-9707 Tool Kit 314818-1 for Breakaway Headers

**Handbook**  
5697

**Guide to Application of ACTION PIN Contact Connectors**

**Note:** All part numbers are RoHS compliant.

## Technical Documents for Wire-to-Board Products

Various technical documents are available for your use.

**Product Specifications** describe technical performance characteristics and verification tests. They are intended for the Design, Component and Quality Engineers.

**Locking Clip Contacts and Housings — Pages 206-209:**

- 108-36028 Connector, Locking Clip, .025 [0.64] Square, Gold
- 108-36028-1 Connector, Locking Clip, .025 [0.64] Square, Tin

**Mod. IV Wire-Applied Contacts and Housings — Pages 210-220:**

- 108-25007 AMPMODU Mod. V Interconnection System, Wire-Applied (High Pressure)
- 108-25019 AMPMODU Mod. IV Male Connectors
- 108-25020 AMPMODU Mod. IV Interconnection System, (Standard Pressure)
- 108-25021 AMPMODU Mod. IV.V Interconnection System, (Intermediate Pressure)

**Short-Point Wire-Applied Contacts and Housings — Pages 221-224:**

- 108-1472 Short-Point Contacts and Housings

**AMPMODU MTE Interconnection System — Pages 225-252:**

- 108-25034 AMPMODU MTE Connectors

**AMPMODU MT and Shielded MT Interconnection System — Pages 255-265:**

- 108-25015 AMPMODU MT Standard Pressure Connectors
- 108-25018 AMPMODU MT High Pressure Connectors
- 108-25030 AMPMODU MT Shielding Accessories

**AMPMODU Level V, IDC Connectors —**

- 108-25028 Interconnection System, Insulation Displacement Connector, IDC Level

**Mini-Tandem Spring Receptacle Contacts — Pages 266-269:**

- 108-25031 Tandem Spring Receptacle Contact

**Application Specifications** describe requirements for using the product in its intended application, and/or crimping information. They are intended for the Packaging and Design Engineers and the Setup person.

**Locking Clip Contacts and Housings — Pages 206-209:**

- 114-25006 Contact, Locking Clip, .025 [0.64] Square, Application of

**Mod. IV Wire-Applied Contacts and Housings — Pages 210-220:**

- 114-25003 AMPMODU Mod. IV (Standard Pressure), AMPMODU Mod. IV.V (Intermediate Pressure) and AMPMODU Mod. V (High Pressure) Receptacle Contacts, Application of
- 114-25016 AMPMODU Mod. IV Crimp Pin Contact

**Short-Point Wire-Applied Contacts and Housings — Pages 221-224:**

- 114-25038 Short-Point Contacts and Housings

**AMPMODU MTE Interconnection System — Pages 225-252:**

- 114-25026 AMPMODU MTE Interconnection System

**AMPMODU MT and Shielded MT Interconnection System — Pages 255-265:**

- 114-25032 AMPMODU MT Interconnection System and Shielding Accessories, Application of

**AMPMODU Level V, IDC Connectors —**

- 114-25020 Interconnection System, IDC Level V, Application of

**Mini-Tandem Spring Receptacle Contacts — Pages 266-269:**

- 114-25021 Tandem Spring Receptacle Contact, Application of

**Note:** All part numbers are RoHS compliant.

## Technical Documents for Wire-to-Board Products (Continued)

**Instruction Sheets** provide instructions for assembling or applying the product. They are intended for the Manufacturing Assembler or Operator.

### Locking Clip Contacts and Housings — Pages 206-209:

408-7604	Tyco Electronics Extraction Tool 91084-1
408-7606	Tyco Electronics Locking Clip Contacts and Connectors
408-7627	Tyco Electronics Hand Crimp Tool 90295-1, 28-30 AWG Wire
408-8547	Tyco Electronics Hand Crimp Tool 91533-1, 22-26 AWG Wire
408-9388	Tyco Electronics Hand Crimp Tool 90431-1, 20 AWG Wire

### Mod. IV Wire-Applied Contacts and Housings — Pages 210-220:

408-4379	Tyco Electronics PRO-CRIMPER II Hand Tool
408-7935	AMPMODU Receptacle Connectors with Strain Relief/Pull Tabs
408-8547	Tyco Electronics Hand Tool 91516-1, 91517-1 and 91541-1
408-9451	Tyco Electronics Extraction Tool 843473-1 for AMPMODU Wire-Applied Housings 86308
408-9453	Tyco Electronics Extraction Tools 843996 and 843477 for Removing AMPMODU Crimp Snap-In Receptacle Contacts from Wire-Applied Housings

### AMPMODU MTE Interconnection System — Pages 225-252:

409-5746	Tyco Electronics Electric Power Unit 931800-1
409-5832	MTE Ribbon Cable Terminator 856002-1
408-6789	Tyco Electronics Pneumatic Pistol Handle 58075-1
408-6790	Tyco Electronics Manual Pistol Handle 58074-1
408-6919	AMPMODU MTE Connectors
408-8547	Tyco Electronics Hand Crimp Tool 91518-1 and 91551-1
408-9230	Tyco Electronics Keying Tool 91417-1
408-9359	MTE Modular Terminating Head 58336-1
408-9393	Tyco Electronics Pneumatic Bench Assy. 58338-1
408-9407	Tyco Electronics Hand Crimp Tool 91531-1 and 58342-2
408-9453	Tyco Electronics Extraction Tools 843996 and 843477 for Removing AMPMODU Crimp Snap-In Receptacle Contacts from Wire-Applied Housings
408-9515	Ribbon Cable Notcher 854449-[]

### AMPMODU MT and Shielded MT Interconnection System — Pages 255-265:

408-6532	AMPMODU MT Connectors
----------	-----------------------

### AMPMODU Level V, IDC Connectors —

408-6843	Tyco Electronics Extraction Tool 91409-1
----------	--

### Standard Tandem Spring and Mini-Tandem Spring Receptacle Contacts — Pages 266-269:

408-7909	Tyco Electronics Hand Crimping Tool 91540-1
----------	---

**Note:** All part numbers are RoHS compliant.



## X-ON Electronics

Largest Supplier of Electrical and Electronic Components

*Click to view similar products for [Headers & Wire Housings](#) category:*

*Click to view products by [TE Connectivity](#) manufacturer:*

Other Similar products are found below :

[95000-104TRLF](#) [10135584-644402LF](#) [DF62W-EP2022PCA](#) [95000-106TRLF](#) [DF62W-2022SCA](#) [DF62W-EP2022PC](#) [2203348](#) [DF62W-2022SC](#) [1084018](#) [1029039](#) [1084017](#) [802-10-012-10-002000](#) [1112640](#) [1112639](#) [000-34000](#) [0009482033](#) [0009507031](#) [57102-S06-03LF](#) [57202-S52-04LF](#) [PCN6-15S-2.5E](#) [0039019024](#) [58102-G61-06LF](#) [582553-1](#) [0009485154](#) [0009508121](#) [0022285053](#) [0050291907](#) [018731A](#) [LY20-4P-DT1-P1E-BR](#) [02.125.8002.8](#) [60101931](#) [60598-1 \(Cut Strip\)](#) [M1625-3R/100](#) [61062-3](#) [61082-181009](#) [636-1427](#) [638009-1](#) [641938-9](#) [641991-4](#) [644168-1](#) [647662-1](#) [65039-019ELF](#) [65781-047](#) [65817-002LF](#) [65817-015LF](#) [65863-015LF](#) [66207-023LF](#) [67016-026LF](#) [67046-001LF](#) [67095-007LF](#)