

ENTERPRISE NETWORKS

EMEA Product Catalog





DATA CENTERS

...where data is stored and processed



IN-BUILDING NETWORKS

...where data meets the user

DATA CENTER AND IN-BUILDING SOLUTIONS FROM TE CONNECTIVITY

All businesses rely upon data and data applications to serve their customers effectively. The data center is at the heart of these applications and TE Connectivity is at the heart of the data center delivering copper and fiber infrastructure solutions that support agile & efficient data center operations.

TE's products for enterprise applications include leading edge fiber, wireless and copper connectivity solutions that build upon our industry leading AMP NETCONNECT and KRONE product lines. We help our customers to build reliable enterprise networks infrastructures and compete in a data intensive world.

te.com/bns

EVERY CONNECTION COUNTS



Contents

Systems by Name:

MPO/MPOptimate System.....	1
MRJ21 System.....	27
Sigma-Link System.....	37
Mixed Media Platform	43
FiberGuide System.....	53
Storage Area Management (SAM)	85
Core VSM System	91
Quareo Physical Layer Management System	97
Optical LAN Solutions	139
AMP CO System	141

Systems by Technology

Fiber Optic Cabling.....	157
Modular Twisted Pair Cabling	217
Home Net-works Residential Cabling	289
Commercial and Industrial Ethernet LAN	295
Administration & Labeling	303
Part Number Index	307

The TE Enterprise Networks Catalog combines AMP NETCONNECT and KRONE portfolios for EMEA

This edition of the Enterprise Networks Product Catalog for our EMEA based customers features products from both the AMP NETCONNECT and KRONE portfolios.

This means that TE Connectivity can offer you a choice from the best of both worlds to address all of your cabling infrastructure needs, no matter if it's a Data Center, an Office Complex or a Campus environment.

In addition to the existing products from these two world class brands, you'll find many exciting, new products as featured on this double page.

The catalog is split into two main sections: the first (chapters 1-10) contains our products organised by the name of the system, and the second (chapters 11-15) makes it easy to find products by technology for example, Twisted Pair or Fiber Optic.

You'll also find useful cross-references in each section to make sure you don't miss the product you are looking for that may be listed in a different section.



MRJ21 XG System – A Pre-Connectorized Plug & Play 10 GbE Copper System

The MRJ21 XG System supports 10 Gigabit Ethernet throughput in all architectures where copper cabling is required. This pre-terminated Plug & Play system enables the data center manager to quickly add additional capacity or services whilst guaranteeing data throughput performance 100% of the time. Also, the lower cable volume deployed in the data center can reduce containment costs, and present less of an obstruction to the airflow entering and exiting the servers and switches.



[Learn more about the MRJ21 XG System from page 27.](#)

Sigma-Link Quick-Fit System - A pre-terminated bundled Copper Cabling Solution

The Sigma-Link Quick-Fit System can be deployed in any application that requires copper twisted pair cabling as the medium of transport. It can be used to connect Users to Switches, Switches to other Switches, or Switches to Servers. Ranging from Category 6 to Category 7A, Sigma-Link supports up to 10 Gigabit Ethernet transmission, and beyond, allowing very high bandwidth applications and protocols to be supported in the future. As a Housing-to-Housing solution it can be quickly located into our UCP panels, taking minimal time to deploy and configure a new channel in the network.



[Learn more about the Sigma-Link Quick-Fit System from page 37.](#)

Storage Area Management – Simplify your Optical Cable Management

TE's Storage Area Management (SAM) Solution for SAN infrastructures is designed to reduce the bulkiness of cabling and connectors in the data center by up to 80% and enable high-density deployment with fewer costly cabinet or infrastructure upgrades. SAM can help you save time, reduce costs, maximize efficiency, and free up much needed space in your data center. It takes the complexity out of cable management, and optimizes the performance of your data center floor space, racks and electronics.

De-clutter your racks for a highly organized, eco-friendly network infrastructure and deliver operational efficiency to your SAN cabling.



[Learn more about the SAM Solution from page 85.](#)

Data Center and In-Building Solutions

Core Vertical Switch Management – Deliver Efficiency to the Core of Your DC

The Core Vertical Switch Management platform (Core VSM) is an innovative solution to the challenges posed in the data center by high-density core switches with a vertical blade configuration.

The platform consists of a cable management guide that fits above the switch and copper or fiber modules that provide connections for blades of either media. The complete Core VSM platform can be installed within an 800 mm wide cabinet, saving valuable white space in the data center.

Within the Core VSM platform, all patch cables, whether fiber or copper, are managed vertically with only one length of patch cord being required to patch within a frame which simplifies the build process and ongoing logistics.

Learn more about the Core VSM Solution from page 91.



Physical Layer Management - Know Your Network!

TE's Quareo physical layer management is an end-to-end solution, combining hardware and software elements to provide accurate visibility on the state of the physical network at all times. It enables easier, smarter network management for everyone from cable installers to network managers, strengthening physical security, boosting availability and providing real-time communication with network assets.

The Quareo physical layer management system leverages an innovative technology called connection point identification (CPID) to capture accurate information on the state of the network. This is done by incorporating chips on connectors throughout the network. Factory installed, these chips are programmed with all the pertinent information about a product, starting with the serial number. Once installed in the network, the product becomes fully discoverable, and the information can be accessed by a technician.

Learn more about Physical Layer Management from page 97.



Optical LAN Solutions – New Ways of Delivering High-Bandwidth to Each Desktop

TE Connectivity offers a complete, end-to-end PON infrastructure solution called Optical LAN Solution (OLS). From the data center to the desktop, our customers have tapped the experience and innovation of TE to build their PON networks. TE's suite of end-to-end connectivity is truly comprehensive and takes a single strand of singlemode fiber from the Data Center all the way to the individual desk or end device location.

Learn more about OLS from page 139.

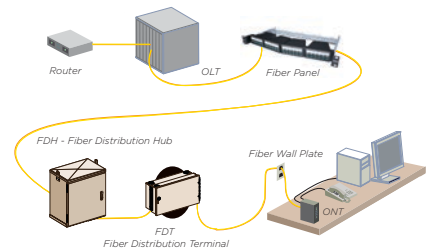

TE Enterprise Networks 25 Year Warranty

WARRANTY SUPPORT FOR THE NEXT 25 YEARS

There are many structured cabling warranties available on the market today but only the TE25 Warranty provides all of this in one package, backed by a multi-billion dollar company with connector technology at the heart of its strategy.



TE Connectivity is committed to being the world's leading provider of enterprise networks infrastructure solutions. With connector technology as the prime focus of our business and a track record in the structured cabling industry through our AMP NETCONNECT and KRONE brands, a TE25 warranty provides the added assurance of a warranty backed by a company with long-term industry stability.

THE TE 25 YEAR SYSTEM WARRANTY PROVIDES COVER ON THE COMPLETE CABLING SYSTEM

- Comprises cable, connectors, connecting hardware and patch cords
- Covers defects in either materials or workmanship for the full 25 years
- Ensures that all signal carrying components meet the prescribed mechanical and transmission specifications for these products
- Includes repair or replacement of defective products— at our cost
- Includes the labor cost

DIRECT TO END USER

The TE25 Warranty is a contract made directly between TE Connectivity and the customer.

How It Works:

1. End user selects TE Connectivity Cabling system
2. End user selects ND&I program installer
3. ND&I installs, tests and documents the cabling system
4. ND&I provides defined project documentation and test results to TE Connectivity
5. TE grants warranty to end user

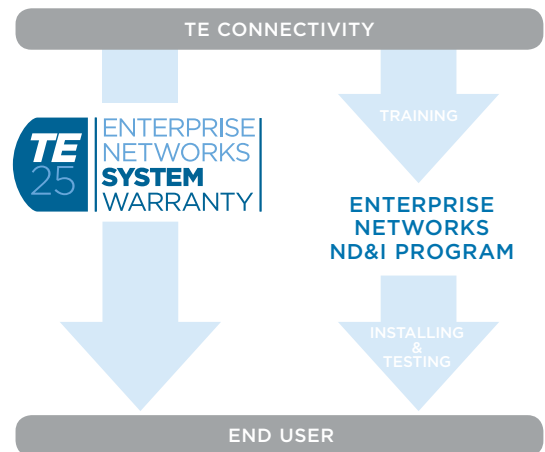

THE TE25 YEAR COMPONENT WARRANTY

For those occasions when a full system warranty is not appropriate, for example where confidentiality or security issues prevent full details of the system being shared with TE, a component warranty is available. Less stringent in terms of the registration requirements and not as comprehensive as the system warranty, it still provides 25 year cover for all TE components to the latest international standards.



1. MPO/MPOptimate System

MPO/MPOptimate Installation and Polarity	02
12 Fiber MPOptimate System.....	03
12 Fiber MPO System.....	09
24 Fiber MPOptimate System.....	14
MPO/MPOptimate Panels & Accessories.....	21
Q3000 Series MPO Fiber Panels	24
MPO/MPOptimate Cleaning Tools.....	26

MPO/MPOOptimate System

MPO/MPOOptimate Installation and Polarity

MPO/MPOOptimate installation and polarity

In each fiber optic system, the link from source (Tx) to receiver (Rx) needs to be flipped once.

In a complete MPO/MPOOptimate link this flipping is provided by one flipped cassette, while all other components in this link shall be installed as straight version.

MPOOptimate ready for 10, 40 and 100 Gb/s

The MPOOptimate system is designed to support 10G Ethernet and 4/8/16G Fiber Channel applications through the complete structure of a Data Center, as specified in ISO/IEC 24764, EN 50173-5 and TIA/EIA 942. The MPOOptimate system is designed to have 6 cassettes per link for 10 Gb/s with a full 300 meter support on OM3 fibers and 550 meter on OM4 fibers.

It offers one passive channel from the end equipment to the core switch without the need of repeating signals for amplifying reasons. When using the MPOOptimate cabling system, the owner can replace aggregation switches by a patch cord without changing the passive infrastructure.

The 24 fiber MPOOptimate system is the first choice to design a flexible cabling system that does support 10-40 and 100G Ethernet over the same trunk cable by means of exchanging the cassettes.

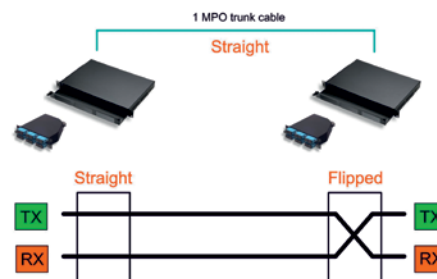

Data Rate	10 Gb/s	40 Gb/s	100 Gb/s
LASER	VCSEL	VCSEL array	VCSEL array
Fibers	2	8	20
Connector	LC duplex	12-fiber MPO	24-fiber MPO
Schematic			
	1:12	1:3	1:1

Length tables for MPO/MPOOptimate trunks and fan-out assemblies

LENGTH TABLE A:

Y- X	Length	Y- X	Length	Y- X	Length	Y- X	Length	Y- X	Length	Y- X	Length	Y- X	Length	Y- X	Length	Y- X	Length
0- 2	2 m	1- 3	13 m	2- 4	24 m	3- 5	35 m	4- 6	46 m	5- 7	57 m	6- 8	68 m	7- 9	79 m	9- 0	90 m
0- 3	3 m	1- 4	14 m	2- 5	25 m	3- 6	36 m	4- 7	47 m	5- 8	58 m	6- 9	69 m	8- 0	80 m	9- 1	91 m
0- 4	4 m	1- 5	15 m	2- 6	26 m	3- 7	37 m	4- 8	48 m	5- 9	59 m	7- 0	70 m	8- 1	81 m	9- 2	92 m
0- 5	5 m	1- 6	16 m	2- 7	27 m	3- 8	38 m	4- 9	49 m	6- 0	60 m	7- 1	71 m	8- 2	82 m	9- 3	93 m
0- 6	6 m	1- 7	17 m	2- 8	28 m	3- 9	39 m	5- 0	50 m	6- 1	61 m	7- 2	72 m	8- 3	83 m	9- 4	94 m
0- 7	7 m	1- 8	18 m	2- 9	29 m	4- 0	40 m	5- 1	51 m	6- 2	62 m	7- 3	73 m	8- 4	84 m	9- 5	95 m
0- 8	8 m	1- 9	19 m	3- 0	30 m	4- 1	41 m	5- 2	52 m	6- 3	63 m	7- 4	74 m	8- 5	85 m	9- 6	96 m
0- 9	9 m	2- 0	20 m	3- 1	31 m	4- 2	42 m	5- 3	53 m	6- 4	64 m	7- 5	75 m	8- 6	86 m	9- 7	97 m
1- 0	10 m	2- 1	21 m	3- 2	32 m	4- 3	43 m	5- 4	54 m	6- 5	65 m	7- 6	76 m	8- 7	87 m	9- 8	98 m
1- 1	11 m	2- 2	22 m	3- 3	33 m	4- 4	44 m	5- 5	55 m	6- 6	66 m	7- 7	77 m	8- 8	88 m	9- 9	99 m
1- 2	12 m	2- 3	23 m	3- 4	34 m	4- 5	45 m	5- 6	56 m	6- 7	67 m	7- 8	78 m	8- 9	89 m		

LENGTH TABLE B:

Y- X	Length	Y- X	Length	Y- X	Length	Y- X	Length	Y- X	Length	Y- X	Length	Y- X	Length	Y- X	Length	Y- X	Length
9- 9	100 m	1- 1	111 m	2- 2	122 m	3- 3	133 m	4- 4	148 m	5- 5	170 m	6- 6	192 m	7- 7	270 m	8- 8	460 m
0- 1	101 m	1- 2	112 m	2- 3	123 m	3- 4	134 m	4- 5	150 m	5- 6	172 m	6- 7	194 m	7- 8	280 m	8- 9	480 m
0- 2	102 m	1- 3	113 m	2- 4	124 m	3- 5	135 m	4- 6	152 m	5- 7	174 m	6- 8	196 m	7- 9	290 m	9- 0	500 m
0- 3	103 m	1- 4	114 m	2- 5	125 m	3- 6	136 m	4- 7	154 m	5- 8	176 m	6- 9	198 m	8- 0	300 m		
0- 4	104 m	1- 5	115 m	2- 6	126 m	3- 7	137 m	4- 8	156 m	5- 9	178 m	7- 0	200 m	8- 1	320 m		
0- 5	105 m	1- 6	116 m	2- 7	127 m	3- 8	138 m	4- 9	158 m	6- 0	180 m	7- 1	210 m	8- 2	340 m		
0- 6	106 m	1- 7	117 m	2- 8	128 m	3- 9	139 m	5- 0	160 m	6- 1	182 m	7- 2	220 m	8- 3	360 m		
0- 7	107 m	1- 8	118 m	2- 9	129 m	4- 0	140 m	5- 1	162 m	6- 2	184 m	7- 3	230 m	8- 4	380 m		
0- 8	108 m	1- 9	119 m	3- 0	130 m	4- 1	142 m	5- 2	164 m	6- 3	186 m	7- 4	240 m	8- 5	400 m		
0- 9	109 m	2- 0	120 m	3- 1	131 m	4- 2	144 m	5- 3	166 m	6- 4	188 m	7- 5	250 m	8- 6	420 m		
1- 0	110 m	2- 1	121 m	3- 2	132 m	4- 3	146 m	5- 4	168 m	6- 5	190 m	7- 6	260 m	8- 7	440 m		

MPO/MPOOptimate System

12 Fiber MPOOptimate System

MPOOptimate to LC Micro-Cassettes and Quick-Fit Modules

FEATURES:

- Pre-terminated low loss cassettes with protocol for constant and reliable quality
- Up to 2 Micro-Cassettes per Quick-Fit Module, 4 modules per UCP panel (1U)
- Easy upgrade from 1 x 12 to 2 x 12 fiber density
- Optical cassette performance both OM3 and OM4:
Attenuation \leq 0.35 dB(max.) RL \geq 27 dB(min)
- Double-sided label strip included with Quick-Fit Module
(Port number labelling either 1-2-3-4-5-6 or 1/6-2/5-3/4-4/3-5/2-6/1)
- Easy to install: front and back access to insert or remove the Micro-Cassette



ORDERING INFORMATION

Description	Pairs straight Part Number	Pairs flipped Part Number
1 x MPOOptimate to 6 x LC Duplex (12 fiber); OM3 XG 10 Gb/s	2153211-3	1-2153211-3
1 x MPOOptimate to 6 x LC Duplex (12 fiber); OM4 XGA 10 Gb/s	2153211-5	1-2153211-5
		Part Number
Quick-Fit modules, holding up to 2 Micro-Cassettes (box of 4 modules + 4 blanking plates)		2153244-1
Quick-Fit modules, holding up to 2 Micro-Cassettes (box of 48 modules + 48 blanking plates)		2153244-2

All cassettes are individually packed per box

MPOOptimate pre-terminated trunks

FEATURES

- Cable terminated with low loss 12 fiber MPOOptimate connectors
- Terminated with female MPO connectors (male versions on request)
- OM3 or OM4 cable performance, LSZH construction
- Connector performance: Attenuation \leq 0.35 dB (max); RL \geq 28 dB (min)
- The trunks are equipped with midi fan-out and 3.2mm round cable MPO tails
- All tails are protected with transparent protection sleeve
- Available in 12, 24 and 48 fiber (other fiber counts on request)
- Factory pre-terminated assemblies with protocol for constant and reliable quality
- Packaging: \leq 50 m in box, $>$ 50 m on reel
- Re-usable pulling socks can be ordered separately.
12 - 24 fiber trunks Part Number 2055567-1
48 fiber trunks Part Number 2055567-2



ORDERING INFORMATION

Description	Part Number 2-99 m - table A	Part Number 100-500 m - table B
12 fiber; OM4 XGA 10 Gb/s; Straight; A wiring	Y-2055576-X	Y-2055577-X
12 fiber; OM4 XGA 10 Gb/s; Male/Male Straight; A wiring	Y-2160658-X	Y-2160659-X
12 fiber; OM4 XGA 10 Gb/s; Male/Male Total Flipped; B wiring	Y-2160729-X	Y-2160730-X
24 fiber; OM4 XGA 10 Gb/s; Straight; A wiring	Y-2055578-X	Y-2055579-X
48 fiber; OM4 XGA 10 Gb/s; Straight; A wiring	Y-2160075-X	Y-2160076-X
12 fiber; OM3 XG 10 Gb/s; A wiring	Y-2055611-X	Y-2055612-X
24 fiber; OM3 XG 10 Gb/s; A wiring	Y-2055715-X	Y-2055716-X
48 fiber; OM3 XG 10 Gb/s; A wiring	Y-2160073-X	Y-2160074-X

For available lengths: see page 02

MPO/MPOOptimate System

12 Fiber MPOOptimate System

MPOOptimate to LC Quick-Fit cassettes

FEATURES

- Pre-terminated low loss cassettes
- Front: 6 x optimized LC Duplex or 6 x optimized LC Quad
- Back: 1 or 2 low loss MPOOptimate connector(s)
- Available in straight or flipped pair version
- Optical cassette performance in OM3 and OM4:
Attenuation \leq 0.35 dB/cassette (max.)
RL \geq 27 dB (min)
- All products with protocol, for constant and reliable quality
- Fits in AMP NETCONNECT Quick-Fit patch panels with maximum density of 4 cassettes per 1U
- Port number labeling and additional label strip included



ORDERING INFORMATION

Description	Pairs straight Part Number	Pairs flipped Part Number
1 x MPOOptimate to 6 x LC Duplex (12 fiber); OM3 XG 10 Gb/s	1671226-3	1-1671226-3
1 x MPOOptimate to 6 x LC Duplex (12 fiber); OM4 XG _A 10 Gb/s	1671226-5	1-1671226-5
2 x MPOOptimate to 6 x LC Quad (24 fiber); OM3 XG 10 Gb/s	1671227-3	1-1671227-3
2 x MPOOptimate to 6 x LC Quad (24 fiber); OM4 XG _A 10 Gb/s	1671227-5	1-1671227-5

MPOOptimate to SC Quick-Fit cassettes

FEATURES

- Pre-terminated low loss cassettes
- Front: 6 x optimized SC Duplex
- Back: 1 x low loss MPOOptimate connector
- Available in straight or flipped pair version
- Optical cassette performance in OM3:
Attenuation \leq 0.35 dB (max.)
RL \geq 27 dB (min)
- All products with protocol, for constant and reliable quality
- Fits in AMP NETCONNECT Quick-Fit patch panels with maximum density of 4 cassettes per 1U

Port number labeling and additional label strip included



ORDERING INFORMATION

Description	Pairs straight Part Number	Pairs flipped Part Number
1 x MPOOptimate to 6 x SC Duplex; (12 fiber): OM3 XG 10 Gb/s	1671228-3	1-1671228-3

MPO/MPOOptimate System

12 Fiber MPOOptimate System

12 Fiber MPOOptimate 40Gb/s Quick-Fit cassettes

FEATURES

- Pre-terminated low loss cassettes
- Front: 6 x optimized LC Quad or 3x 8 fiber MPOOptimate connectors
- Back: 2 low loss 12 fiber MPOOptimate connector(s)
- OM4 Optical cassette performance
Attenuation $\leq 0.35\text{dB}$ (MPO/LC) or $\leq 0.5\text{dB}$ (MPO/MPO) cassette (max.)
RL ≥ 27 dB (min)
- All products with protocol, for constant and reliable quality
- Fits in AMP NETCONNECT Quick-Fit patch panels with maximum density of 4 cassettes per 1U
- Port number labeling and additional label strip included



ORDERING INFORMATION

Description	Pairs straight Part Number	Pairs flipped Part Number
2 x MPOOptimate to 6 x LC Quad (24 fiber); OM4 XGA 10 Gb/s Note: to be used with 2160056-5 in same channel	1671227-5	n/a
2 x MPOOptimate to 3x 8fiber 40Gb/s MPOOptimate	216056-5	1-216056-5

MPOOptimate patch cords

FEATURES

- Low loss MPOOptimate 12 fiber MPO round cable patch cord
- Terminated with male and/or female MPOOptimate connectors
- Cable performance: OM4; OM3 XG 10 Gb/s; LSZH construction
- Connector performance: Attenuation ≤ 0.35 dB (max.); RL ≥ 28 dB (min)
- All products with protocol, for constant and reliable quality
- Available in female/female and male/female version in straight "A" wiring and total flipped "B" wiring

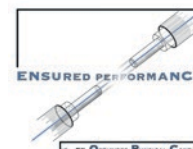

Color: aqua

LENGTH TABLE(MTR):

Y- -X	Length	Y- -X	Length	Y- -X	Length	Y- -X	Length	Y- -X	Length	Y- -X	Length	Y- -X	Length	Y- -X	Length		
9- -0	0,5	9- -5	5,5	1- -1	11	2- -1	21	3- -1	31	4- -1	41	5- -1	51	6- -1	61	7- -1	71
0- -1	1,0	0- -6	6,0	1- -2	12	2- -2	22	3- -2	32	4- -2	42	5- -2	52	6- -2	62	7- -2	72
9- -1	1,5	9- -6	6,5	1- -3	13	2- -3	23	3- -3	33	4- -3	43	5- -3	53	6- -3	63	7- -3	73
0- -2	2,0	0- -7	7,0	1- -4	14	2- -4	24	3- -4	34	4- -4	44	5- -4	54	6- -4	64	7- -4	74
9- -2	2,5	9- -7	7,5	1- -5	15	2- -5	25	3- -5	35	4- -5	45	5- -5	55	6- -5	65	7- -5	75
0- -3	3,0	0- -8	8,0	1- -6	16	2- -6	26	3- -6	36	4- -6	46	5- -6	56	6- -6	66	7- -6	76
9- -3	3,5	9- -8	8,5	1- -7	17	2- -7	27	3- -7	37	4- -7	47	5- -7	57	6- -7	67	7- -7	77
0- -4	4,0	0- -9	9,0	1- -8	18	2- -8	28	3- -8	38	4- -8	48	5- -8	58	6- -8	68	7- -8	78
9- -4	4,5	9- -9	9,5	1- -9	19	2- -9	29	3- -9	39	4- -9	49	5- -9	59	6- -9	69	7- -9	79
0- -5	5,0	1- -0	10	2- -0	20	3- -0	30	4- -0	40	5- -0	50	6- -0	60	7- -0	70	8- -0	80

ORDERING INFORMATION

Description	Straight type A wiring Part Number	Total flipped type B wiring Part Number
MPOOptimate female - MPOOptimate female patch cord; OM3 XG 10 Gb/s	Y-2160135-X	Y-2160193-X
MPOOptimate female - MPOOptimate female patch cord; OM4 XGA 10 Gb/s	Y-2160136-X	Y-2160194-X
MPOOptimate female - MPOOptimate male patch cord; OM3 XG 10 Gb/s	Y-2160139-X	Y-2160197-X
MPOOptimate female - MPOOptimate male patch cord; OM4 XGA 10 Gb/s	Y-2160140-X	Y-2160198-X

MPO/MPOptimate System

12 Fiber MPOptimate System

MPOptimate Fan-Out Trunk Cable Assemblies

FEATURES

- Low loss transition from 3.2mm MPO to LC or SC tails 2 mm
- Terminated with female or male MPOptimate connectors
- Cable: 6.4mm OM4 or OM3 XG 10 Gb/s; Loose Tube LSZH construction
- Optical performance:
MPO connector: Attenuation \leq 0.35 dB (max.); RL \geq 28 dB (min)
LC/SC connector: Attenuation \leq 0.15 dB (max); RL \geq 35 dB (min)
- All products with protocol, for constant and reliable quality
- Tail lengths: 4 x 40 cm, 4 x 50 cm, 4 x 60 cm. Other tail lengths available on request
- All tails are protected with transparent protection sleeve
- Packaging: \leq 50 m in box, >50 m on reel
- Re-usable pulling socks can be ordered separately. Part Number 2055567-1
- Typical application: inter rack equipment/patch panel connections



ORDERING INFORMATION

Description	Part Number	Part Number
	2-99 m - table A	100-500 m - table B
1 x MPOptimate female to 12 x LC Simplex; OM4 XGA 10 Gb/s	Y-2055580-X	Y-2055581-X
1 x MPOptimate female to 12 x SC Simplex; OM4 XGA 10 Gb/s	Y-2160114-X	Y-2160115-X
1 x MPOptimate female to 12 x LC Simplex; OM3 XG 10 Gb/s	Y-2055623-X	Y-2055624-X
1 x MPOptimate female to 12 x SC Simplex; OM3 XG 10 Gb/s	Y-2160112-X	Y-2160113-X
1 x MPOptimate male to 12 x LC Simplex; OM4 XGA 10 Gb/s	Y-2160146-X	Y-2160147-X
1 x MPOptimate male to 12 x SC Simplex; OM4 XGA 10 Gb/s	Y-2160126-X	Y-2160127-X
1 x MPOptimate male to 12 x LC Simplex; OM3 XG 10 Gb/s	Y-2055600-X	Y-2055704-X

For available lengths: see 02

MPO/MPOptimate System

12 Fiber MPOptimate System

MPOptimate Fan-Out Patch Cable Assemblies

FEATURES

- Low loss transition from 3.2mm MPO cable to 2mm LC tails
- Terminated with female or male MPOptimate connectors
- Cable performance: OM4 or OM3 XG 10 Gb/s; LSZH construction
- Optical performance:
 - MPO connector: Attenuation \leq 0.35 dB (max.); RL \geq 28 dB (min)
 - LC connector: Attenuation \leq 0.15 dB (max.); RL \geq 35 dB(min)
- All products with protocol, for constant and reliable quality
- Tail lengths: see table. (Other tail lengths available on request)
- Typical application: intra rack equipment connections

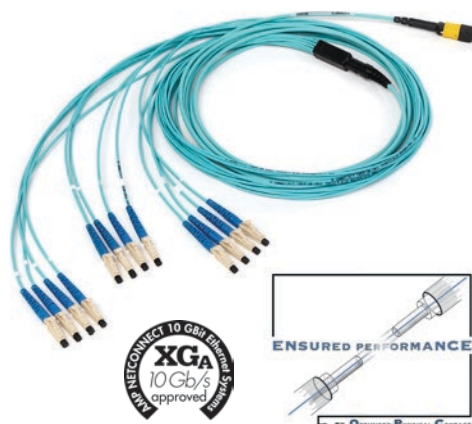

ORDERING INFORMATION

Description	LC tail length (cm)	Part Number 2-99 m - table A
1 x MPOptimate male to 12 x LC Simplex; OM3 XG 10 Gb/s	4x 92+ 4x 96 + 4x 100	2160069
1 x MPOptimate male to 12 x LC Simplex; OM3 XG 10 Gb/s	4x40 + 4x50 + 4x60	2055691
1 x MPOptimate male to 12 x LC Simplex; OM3 XG 10 Gb/s	4x20 + 4x24 + 4x28	2160693
1 x MPOptimate male to 12 x LC Simplex; OM4 XGA 10 Gb/s	4x 92+ 4x 96 + 4x 100	2160067
1 x MPOptimate male to 12 x LC Simplex; OM4 XGA 10 Gb/s	4x 192+ 4x 196 + 4x 200	2160546

LENGTH TABLE(MTR):

Y-X	Length	Y-X	Length	Y-X	Length	Y-X	Length	Y-X	Length	Y-X	Length	Y-X	Length	Y-X	Length		
9-0	0,5	9-5	5,5	1--1	11	2--1	21	3--1	31	4--1	41	5--1	51	6--1	61	7--1	71
0-1	1,0	0--6	6,0	1--2	12	2--2	22	3--2	32	4--2	42	5--2	52	6--2	62	7--2	72
9-1	1,5	9--6	6,5	1--3	13	2--3	23	3--3	33	4--3	43	5--3	53	6--3	63	7--3	73
0-2	2,0	0--7	7,0	1--4	14	2--4	24	3--4	34	4--4	44	5--4	54	6--4	64	7--4	74
9-2	2,5	9--7	7,5	1--5	15	2--5	25	3--5	35	4--5	45	5--5	55	6--5	65	7--5	75
0-3	3,0	0--8	8,0	1--6	16	2--6	26	3--6	36	4--6	46	5--6	56	6--6	66	7--6	76
9-3	3,5	9--8	8,5	1--7	17	2--7	27	3--7	37	4--7	47	5--7	57	6--7	67	7--7	77
0-4	4,0	0--9	9,0	1--8	18	2--8	28	3--8	38	4--8	48	5--8	58	6--8	68	7--8	78
9-4	4,5	9--9	9,5	1--9	19	2--9	29	3--9	39	4--9	49	5--9	59	6--9	69	7--9	79
0-5	5,0	1--0	10	2--0	20	3--0	30	4--0	40	5--0	50	6--0	60	7--0	70	8--0	80

MPO/MPOptimate System

12 Fiber MPOptimate System

MPOptimate System LC and SC patch cords

FEATURES

- Patch cords with optimized LC and SC connectors
- Cable performance: OM4 or OM3 XG 10 Gb/s; LSZH construction
- Optical performance:
 - LC connector: Attenuation \leq 0.15 dB (max); RL \geq 35 dB(min)
 - SC connector: Attenuation \leq 0.15 dB (max); RL \geq 35 dB(min)
- All products with protocol, for constant and reliable quality



Y- -X	Length
0- -1	1 m
0- -3	3 m
0- -5	5 m
1- -0	10 m

ORDERING INFORMATION

Description	Part Number
Patch cord LC Duplex - LC Duplex; OM3 XG 10 Gb/s	Y-1920743-X
Patch cord SC Duplex - SC Duplex; OM3 XG 10 Gb/s	Y-2055108-X
Patch cord LC Duplex - SC Duplex; OM3 XG 10 Gb/s	Y-2055109-X
Patch cord LC Duplex - LC Duplex; OM4 XGA 10 Gb/s	Y-2160046-X
Patch cord SC Duplex - SC Duplex; OM4 XGA 10 Gb/s	Y-2160047-X
Patch cord LC Duplex - SC Duplex; OM4 XGA 10 Gb/s	Y-2160048-X

Pre-terminated MPO trunk cable, 12/24/48 fiber

FEATURES

- Factory pre-terminated assemblies
- Cables terminated with high density MPO connectors
- All products with protocol, for constant and reliable quality
- In OM3 and OS2 design with LSZH sheath
- Available in lengths from 2 up to 500 m
- The trunks are equipped with midi fan-out and 3.2mm round cable MPO tails
- All tails are protected with transparent protection sleeve
- Available in 12, 24 and 48 fiber (other fiber counts on request)
- Packaging: \leq 50 m in box, $>$ 50 m on reel
- Re-usable pulling socks can be ordered separately.
 - 12 and 24 fibre trunks Part number 2055567-1
 - 48 fibre trunks Part number 2055567-2



ORDERING INFORMATION

Description	Part Number	Part Number
	2-99 m - table A	100-500 m - table B
12 Fiber; OM3 XG 10 Gb/s; Straight "A" wiring	Y-2055707-X	Y-2055708-X
24 Fiber; OM3 XG 10 Gb/s; Straight "A" wiring	Y-2055709-X	Y-2055710-X
48 Fiber; OM3 XG 10 Gb/s; Straight "A" wiring	Y-2160071-X	Y-2160072-X
12 Fiber; SM; Straight "A" wiring	Y-2055711-X	Y-2055712-X
24 Fiber; SM; Straight "A" wiring	Y-2055713-X	Y-2055714-X
48 Fiber; SM; Straight "A" wiring	Y-2160077-X	Y-2160078-X

For available lengths: see page 02

MPO/MPOptimate System

12 Fiber MPO System

MPO to LC Quick-Fit cassettes

FEATURES

- Simple and flexible premises fiber cabling
- Pre-terminated cassettes with either 1 or 2 MPO trunk connections (1 x 12 or 2 x 12 fibers) at rear
- 6 x LC Duplex (12 fibers) or 6 x LC Quad (24 fibers) connection in the front
- All products with protocol, for constant and reliable quality
- Easy installation, moves, adds and changes
- Fits in all AMP NETCONNECT Patch Panels for Quick-Fit Modules
- Panels accept up to 4 cassettes achieving up to 96 fiber connections on 1U

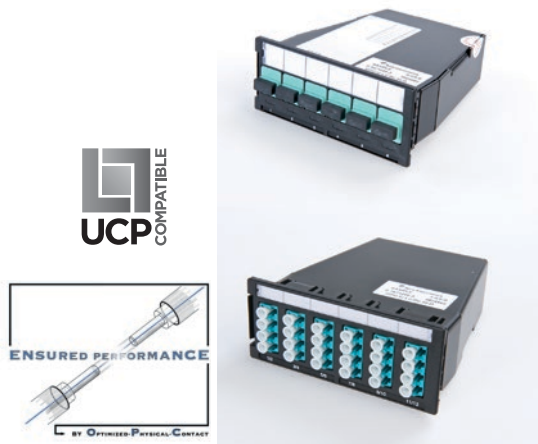

ORDERING INFORMATION

Description	Pairs straight Part Number	Pairs flipped Part Number
1 x MPO to 6 x LC Duplex; OM3 XG 10 Gb/s	1671205-3	1-1671205-3
2 x MPO to 6 x LC Quad; OM3 XG 10 Gb/s	1671206-3	1-1671206-3
1 x MPO to 6 x LC Duplex; SM	1671205-4	1-1671205-4
1 x MPO to 6 x LC APC Duplex; SM	1671205-6	1-1671205-6
2 x MPO to 6 x LC Quad; SM	1671206-4	1-1671206-4
2 x MPO to 6 x LC APC Quad; SM	1671206-6	1-1671206-6

MPO to SC Quick-Fit cassettes

FEATURES

- Simple and flexible premises fiber cabling
- Pre-terminated cassettes with 1 MPO trunk connection (1 x 12 fibers) at rear
- 6 x SC Duplex (12 fibers) connections in the front
- All products with protocol, for constant and reliable quality
- Easy installation, moves, adds and changes
- Fits in all AMP NETCONNECT Patch Panels for Quick-Fit Modules
- Panels accept up to 4 cassettes on 1U



ORDERING INFORMATION

Description	Pairs straight Part Number	Pairs flipped Part Number
1 x MPO to 6 x SC Duplex; OM3 XG 10 Gb/s	1671207-3	1-1671207-3
1 x MPO to 6 x SC Duplex; SM	1671207-4	1-1671207-4
1 x MPO to 6 x SC APC Duplex; SM	1671207-6	1-1671207-6

MPO/MPOOptimate System

12 Fiber MPO System

MPO patch cords

FEATURES

- MPO patch cord
- Cable performance: OM3 or OS2; LSZH 3.2mm round cable construction
- All products with protocol, for constant and reliable quality
- Available in female/female and male/female version in straight "A" wiring and total flipped wiring "B" wiring

Color: aqua



LENGTH TABLE (MTR):

Y- -X	Length	Y- -X	Length	Y- -X	Length	Y- -X	Length	Y- -X	Length	Y- -X	Length	Y- -X	Length	Y- -X	Length		
9- -0	0,5	9- -5	5,5	1- -1	11	2- -1	21	3- -1	31	4- -1	41	5- -1	51	6- -1	61	7- -1	71
0- -1	1,0	0- -6	6,0	1- -2	12	2- -2	22	3- -2	32	4- -2	42	5- -2	52	6- -2	62	7- -2	72
9- -1	1,5	9- -6	6,5	1- -3	13	2- -3	23	3- -3	33	4- -3	43	5- -3	53	6- -3	63	7- -3	73
0- -2	2,0	0- -7	7,0	1- -4	14	2- -4	24	3- -4	34	4- -4	44	5- -4	54	6- -4	64	7- -4	74
9- -2	2,5	9- -7	7,5	1- -5	15	2- -5	25	3- -5	35	4- -5	45	5- -5	55	6- -5	65	7- -5	75
0- -3	3,0	0- -8	8,0	1- -6	16	2- -6	26	3- -6	36	4- -6	46	5- -6	56	6- -6	66	7- -6	76
9- -3	3,5	9- -8	8,5	1- -7	17	2- -7	27	3- -7	37	4- -7	47	5- -7	57	6- -7	67	7- -7	77
0- -4	4,0	0- -9	9,0	1- -8	18	2- -8	28	3- -8	38	4- -8	48	5- -8	58	6- -8	68	7- -8	78
9- -4	4,5	9- -9	9,5	1- -9	19	2- -9	29	3- -9	39	4- -9	49	5- -9	59	6- -9	69	7- -9	79
0- -5	5,0	1- -0	10	2- -0	20	3- -0	30	4- -0	40	5- -0	50	6- -0	60	7- -0	70	8- -0	80

ORDERING INFORMATION

Description	Straight Type A wiring Part Number	Total flipped Type B wiring Part Number
MPO female - MPO female Patch Cord; OM3 XG 10 Gb/s	Y-2160134-X	Y-2160192-X
MPO female - MPO female Patch Cord; SM	Y-2160137-X	Y-2160195-X
MPO male - MPO female Patch Cord; OM3 XG 10 Gb/s	Y-2160138-X	Y-2160196-X
MPO male - MPO female Patch Cord; SM	Y-2160141-X	Y-2160199-X

MPO/MPOptimate System

12 Fiber MPO System

MPO Fan-Out Trunk Cable Assemblies

FEATURES

- 3.2mm MPO round cable to LC or SC 12 x 2 mm tails
- Terminated with female or male MPO connectors
- Cable: 6.4mm OM3 or OS2, Loose Tube LSZH construction
- All products with protocol, for constant and reliable quality
- Tail lengths: 4 x 40cm, 4 x 50cm, 4 x 60cm (other tail lengths available on request).
- All tails are protected with transparent protection sleeve
- Packaging: ≤50 m in box, >50 m on reel
- Re-usable pulling socks can be ordered separately. Part Number 2055567-1
- Typical application: inter rack equipment/patch panel connections



ORDERING INFORMATION

Description	Part Number 2-99 m - table A	Part Number 100-500 m - table B
1 x MPO female to 12 x LC Simplex; OM3 XG 10 Gb/s	Y-2160106-X	Y-2160107-X
1 x MPO female to 12 x LC Simplex; SM	Y-2160108-X	Y-2160109-X
1 x MPO female to 12 x SC Simplex; OM3 XG 10 Gb/s	Y-2160110-X	Y-2160111-X
1 x MPO female to 12 x SC Simplex; SM	Y-2160116-X	Y-2160117-X
1 x MPO male to 12 x LC Simplex; OM3 XG 10 Gb/s	Y-2160012-X	Y-2160013-X
1 x MPO male to 12 x LC Simplex; SM	Y-2160122-X	Y-2160123-X
1 x MPO male to 12 x SC Simplex; OM3 XG 10 Gb/s	Y-2160124-X	Y-2160125-X
1 x MPO male to 12 x SC Simplex; SM	Y-2160128-X	Y-2160129-X

For available lengths: see page 02

MPO/MPOptimate System

12 Fiber MPO System

Patch Leads – Technical Data

SC Assemblies

Cable sheath:	LSZH
Cable diameter:	2.5 mm Twin Zip
Ferrule	Ceramic

LC Assemblies

Cable sheath:	LSZH
Cable diameter:	1.8 mm Mini Twin Zip
Ferrule	Ceramic

All assemblies are machine polished providing highest quality.

Multimode OM3 and singlemode OS2 assemblies have an ensured performance by Optimized-Physical-Contact (OPC).

All assemblies are factory tested and come with a test protocol.

Insertion Loss and Return Loss values specified against reference connectors.

Singlemode Patch Cords

Connector Type	Attenuation max.	Return loss. min.	Temp. Range
SC, PC	0,3 dB	> 45 dB	-10°C / +60°C
LC, PC	0,3 dB	> 45 dB	-10°C / +60°C

Multimode Patch Cords

Connector Type	Attenuation max.	Return loss. min.	Temp. Range
SC, PC	0,3 dB	> 20 dB	-10°C / +60°C
LC, PC	0,3 dB	> 20 dB	-10°C / +60°C

LC Duplex / LC Duplex patch cords

FEATURES

- All assemblies are machine polished providing highest quality.
- Multimode OM3 and singlemode OS2 assemblies have an ensured performance by Optimized-Physical-Contact (OPC).
- All assemblies are factory tested and come with a test protocol



ORDERING INFORMATION

Description	Part Number
OS2	Y-6536501-X
OM3 XG 10 Gb/s	Y-6536969-X

Y- -X	Length
0- -1	1 m
0- -2	2 m
0- -3	3 m
0- -5	5 m
1- -0	10 m

MPO/MPOptimate System

12 Fiber MPO System

LC Duplex / SC Duplex patch cords

FEATURES

- All assemblies are machine polished providing highest quality.
- Multimode OM3 and singlemode OS2 assemblies have an ensured performance by Optimized-Physical-Contact (OPC).
- All assemblies are factory tested and come with a test protocol



ORDERING INFORMATION

Description	Part Number
OS2	Y-6536508-X
OM3 XG 10 Gb/s	Y-6536967-X

Y- -X	Length
0- -1	1 m
0- -2	2 m
0- -3	3 m
0- -5	5 m
1- -0	10 m

SC Duplex / SC Duplex patch cords

FEATURES

- All assemblies are machine polished providing highest quality.
- Multimode OM3 and singlemode OS2 assemblies have an ensured performance by Optimized Physical Contact (OPC).
- All assemblies are factory tested and come with a test protocol

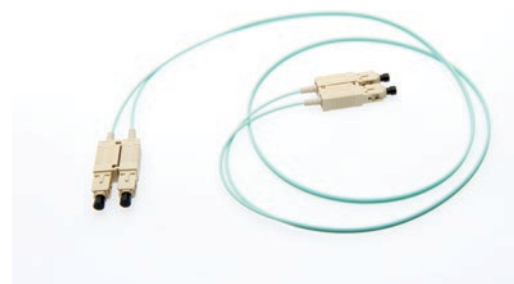

ORDERING INFORMATION

Description	Part Number
OS2	Y-6348260-X
OM3 XG 10 Gb/s	Y-6536464-X

Y- -X	Length
0- -1	1 m
0- -2	2 m
0- -3	3 m
0- -5	5 m
1- -0	10 m

MPO/MPOptimate System

24 Fiber MPOptimate System

24 Fiber MPOptimate System

Demand for bandwidth and storage is expanding at a breathtaking rate within the data center, which means that the environment is rapidly evolving, making the impact on data center design and management profound.

Networks will need to be ready to migrate from 10 to 40 to 100 GbE speeds dynamically, whilst data center managers and designers need to be able to manage this migration to maximize efficiency and responsiveness while minimizing cost.

Preparing for this trend demands a simple yet robust migration pathway.

As part of TE Connectivity's data center solution, the 24 Fiber MPOptimate system enables such a plan, supporting the migration of increasing data speeds required to support the next generation of servers, storage and switching platforms.



SYSTEM FEATURES:

- Low-loss 24 fiber MPOptimate modules
- Fast interfacing, "trouble free" of gender and polarity issues
- Low loss 24 fiber MPOptimate trunks
- Supporting 10/40/100GbE throughput
- A single trunking format that can be replicated and upgraded simply and flexibly
- Pre-engineered paths and polarity
- 24 Fiber trunk systems offer higher fiber utilization versus 12 fiber trunk systems
- Fewer trunks: less containment space needed leading to lower initial build costs.
- Fewer connections: faster time to turn up circuits
- Fewer components
- Standardized practices for design, installation, documentation and troubleshooting polarity
- Each product is individually tested to ensure that its performance meets or exceeds the required standard. The test results are supplied with each product.

MPO/MPOptimate System

24 Fiber MPOptimate System

MPOptimate 24f pre-terminated trunks

FEATURES

- Loose tube cable construction, ideal for routing through cable tray or raceway
- Cable terminated with low loss 24 fiber MPOptimate connectors
- Terminated with female MPO connectors (male versions on request)
- OM3, OM4 cable performance, LSZH construction
- Connector performance for OM3/OM4:
Attenuation ≤ 0.25 dB (max.);
RL ≥ 28 dB (min)
- The trunks are equipped with midi fan-out and 3.8mm round cable MPO tails (80cm)
- All tails are protected with transparent protection sleeve
- Factory pre-terminated assemblies
- All products with protocol, for constant and reliable quality
- Packaging: ≤ 50 m in box, > 50 m on reel
- Re-usable pulling socks can be ordered separately. Part Number 2055567-1

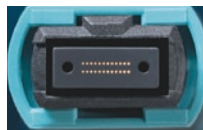

Color: aqua

ORDERING INFORMATION

Description	Part Number 2-99 m - table A	Part Number 100-500 m - table B
24 fiber; OM3; Straight A wiring;	Y-2160663-X	Y-2160664-X
24 fiber; OM4; Straight A wiring;	Y-2160608-X	Y-2160609-X

For available lengths: see 02

MPO/MPOptimate System

24 Fiber MPOptimate System

10Gb/s Cassettes – 1x24 fiber MPO to 6 LC Quad connectors



FEATURES

- Pre-terminated low loss cassettes
- Front: 6 x optimized LC Quad
- Back: 1 x 24 fiber low loss MPOptimate connector
- Optical cassette performance for OM3/OM4:
Attenuation ≤ 0.35 dB(max.) RL ≥ 27 dB(min)
- All products with protocol, for constant and reliable quality
- Port number labelling and additional label strip included



ORDERING INFORMATION

Description	Part Number straight	Part Number flipped
1x24 fiber MPO to 6x LC Quad OM4	2160266-5	1-2160266-5
1x24 fiber MPO to 6x LC Quad OM3	2160266-3	1-2160266-3

40GbE (4 x 10GbE) Cassette – 1x24 fiber MPO to 6 LC Quad connectors



FEATURES:

- Quick-Fit design, fits in all UCP products
- OM4 bend insensitive fiber
- For channel with 40G MPO cassettes connected to 40G (4x10G) transceiver
- Cassette attenuation: typical 0.25dB/max. 0.35dB
- Cassette Return Loss: 27dB min



ORDERING INFORMATION

Description	Wire map	Part Number
1x24 fiber MPO to 6x LC Quad	Special 40/10G	2160640-5

40Gb/s Cassette – 1x24 fiber MPO to 3x12 (8) fiber MPO connectors



FEATURES:

- Quick-Fit design, fits in all UCP products
- OM4 bend insensitive fiber
- Cassette attenuation: typical 0.36dB/max. 0.5dB
- Cassette Return Loss: 27dB min

ORDERING INFORMATION

Description	Wire map	Part Number
1x24 fiber MPO to 3x12(8) fiber MPO	Universal	2160639-5



MPO/MPOOptimate System

24 Fiber MPOOptimate System

40Gb/s Cassette - 2x24 fiber MPO to 6x12 (8) fiber MPO connectors

FEATURES:

- Quick-Fit design, fits in all UCP products
- OM4 bend insensitive fiber
- Cassette attenuation: typical 0.36dB/max. 0.5dB
- Cassette Return Loss: 27dB min



ORDERING INFORMATION

Description	Wire map	Part Number
2x24 fiber MPO to 6x12(8) fiber MPO	Universal	2160649-5



100Gb/s Cassette - 1x24 fiber MPO to 1x24 fiber MPO connector

FEATURES:

- Quick-Fit design, Fits in all UCP products
- OM4 bend insensitive fiber
- Cassette attenuation: typical 0.36dB/max. 0.5dB
- Cassette Return Loss: 27dB min



ORDERING INFORMATION

Description	Wire map	Part Number
1x24 fiber MPO to 1x24 fiber MPO	Polarity A	2160650-5
1x24 fiber MPO to 1x24 fiber MPO	Polarity B	1-2160650-5



100Gb/s Cassette - 2x24 fiber MPO to 2x24 fiber MPO connectors

FEATURES:

- Quick-Fit design, fits in all UCP products
- OM4 bend insensitive fiber
- Cassette attenuation: typical 0.36dB/max. 0.5dB
- Cassette Return Loss: 27dB min



ORDERING INFORMATION

Description	Wire map	Part Number
2x24 fiber MPO to 2x24 fiber MPO	Polarity A	2160651-5
2x24 fiber MPO to 2x24 fiber MPO	Polarity B	1-2160651-5



MPO/MPOOptimate System

24 Fiber MPOOptimate System

MPOOptimate 24f patch cords

FEATURES

- For direct connection of 100G transceivers
- Construction suited to inter-cabinet patching
- Low loss MPOOptimate 24 fiber MPO round 3.8mm cable patch cord
- OM3 and OM4 cable performance, LSZH construction
- Connector performance for OM3/OM4:
Attenuation \leq 0.25 dB (max.); RL \geq 28 dB (min)
- All products with protocol, for constant and reliable quality



Color: aqua



LENGTH TABLE:

Y- -X	Length	Y- -X	Length	Y- -X	Length	Y- -X	Length	Y- -X	Length	Y- -X	Length	Y- -X	Length	Y- -X	Length		
9- -0	0,5	9- -5	5,5	1- -1	11	2- -1	21	3- -1	31	4- -1	41	5- -1	51	6- -1	61	7- -1	71
0- -1	1,0	0- -6	6,0	1- -2	12	2- -2	22	3- -2	32	4- -2	42	5- -2	52	6- -2	62	7- -2	72
9- -1	1,5	9- -6	6,5	1- -3	13	2- -3	23	3- -3	33	4- -3	43	5- -3	53	6- -3	63	7- -3	73
0- -2	2,0	0- -7	7,0	1- -4	14	2- -4	24	3- -4	34	4- -4	44	5- -4	54	6- -4	64	7- -4	74
9- -2	2,5	9- -7	7,5	1- -5	15	2- -5	25	3- -5	35	4- -5	45	5- -5	55	6- -5	65	7- -5	75
0- -3	3,0	0- -8	8,0	1- -6	16	2- -6	26	3- -6	36	4- -6	46	5- -6	56	6- -6	66	7- -6	76
9- -3	3,5	9- -8	8,5	1- -7	17	2- -7	27	3- -7	37	4- -7	47	5- -7	57	6- -7	67	7- -7	77
0- -4	4,0	0- -9	9,0	1- -8	18	2- -8	28	3- -8	38	4- -8	48	5- -8	58	6- -8	68	7- -8	78
9- -4	4,5	9- -9	9,5	1- -9	19	2- -9	29	3- -9	39	4- -9	49	5- -9	59	6- -9	69	7- -9	79
0- -5	5,0	1- -0	10	2- -0	20	3- -0	30	4- -0	40	5- -0	50	6- -0	60	7- -0	70	8- -0	80

ORDERING INFORMATION

Description	Part Number
24 fiber; OM4; Straight A wiring; Female/Female	Y-2160304-X
24 fiber; OM4; Straight A wiring; Female/Male	Y-2160307-X
24 fiber; OM4; Straight A wiring; Male/Male	Y-2160738-X
24 fiber; OM4; Flipped B wiring; Female/Male	Y-2160654-X
24 fiber; OM4; Flipped B wiring; Male/Male	Y-2160694-X
24 fiber; OM3; Straight A wiring; Female/Female	Y-2160305-X

MPO/MPOOptimate System

24 Fiber MPOOptimate System

40GbE to 10GbE Fan-Out cords - 12 fiber MPO to 4xLC duplex (Fan-Out)

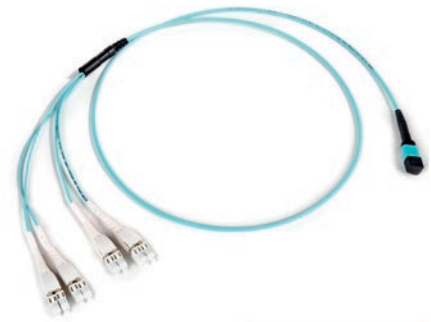

FEATURES:

- MPO side connects to 40G QSFP transceiver, LC side connects to 10G SPF+ (channel)
- Wire map: LC 1-MPO fiber 1-12, LC2-MPO fiber 2-11, LC3-MPO fiber 3-10, LC4-MPO fiber 4-9
- 8 fiber 3,2/2,0mm diameter
- OM4 bend insensitive fiber LSZH cable
- Flammability IEC 60332 Parts 1 & 3

Color: Aqua



LENGTH TABLE:

Y- X	Length	Y- X	Length	Y- X	Length	Y- X	Length	Y- X	Length	Y- X	Length	Y- X	Length	Y- X	Length		
9- 0	0,5	9- 5	5,5	1- -1	11	2- -1	21	3- -1	31	4- -1	41	5- -1	51	6- -1	61	7- -1	71
0- -1	1,0	0- -6	6,0	1- -2	12	2- -2	22	3- -2	32	4- -2	42	5- -2	52	6- -2	62	7- -2	72
9- -1	1,5	9- -6	6,5	1- -3	13	2- -3	23	3- -3	33	4- -3	43	5- -3	53	6- -3	63	7- -3	73
0- -2	2,0	0- -7	7,0	1- -4	14	2- -4	24	3- -4	34	4- -4	44	5- -4	54	6- -4	64	7- -4	74
9- -2	2,5	9- -7	7,5	1- -5	15	2- -5	25	3- -5	35	4- -5	45	5- -5	55	6- -5	65	7- -5	75
0- -3	3,0	0- -8	8,0	1- -6	16	2- -6	26	3- -6	36	4- -6	46	5- -6	56	6- -6	66	7- -6	76
9- -3	3,5	9- -8	8,5	1- -7	17	2- -7	27	3- -7	37	4- -7	47	5- -7	57	6- -7	67	7- -7	77
0- -4	4,0	0- -9	9,0	1- -8	18	2- -8	28	3- -8	38	4- -8	48	5- -8	58	6- -8	68	7- -8	78
9- -4	4,5	9- -9	9,5	1- -9	19	2- -9	29	3- -9	39	4- -9	49	5- -9	59	6- -9	69	7- -9	79
0- -5	5,0	1- -0	10	2- -0	20	3- -0	30	4- -0	40	5- -0	50	6- -0	60	7- -0	70	8- -0	80

ORDERING INFORMATION

Description	Wire map	Part Number
12 fiber MPO to 4x LC duplex cable.	Special 40/10G	Y-2160510-X

MPO/MPOptimate System

24 Fiber MPOptimate System

12 Fiber MPOptimate Quick-Fit Cassette – 40Gb/s to 10Gb/s

FEATURES

- Pre-terminated low loss cassettes
- Front: 4 x optimized LC Duplex adapters
- Back: 1 x 12 fiber low loss MPOptimate connector
- Optical cassette performance OM4:
Attenuation ≤ 0.35 dB(max.) RL ≥ 27 dB(min)
- Special wiremap to be used in combination with 40G QSFP SR4 transceivers
- All products with protocol, for constant and reliable quality
- Port number labelling and additional label strip included



ORDERING INFORMATION

Description	Wire map	Part Number
12 fiber MPO/LC Quick-Fit cassette OM4	40Gb/s to10Gb/s	2160627-5

MPO/MPOptimate System

MPO/MPOptimate Panels & Accessories

UCP Patch Panel Angled and Flushmount

Please refer to Chapter 4, page 50

Note: For angled modular drawer panels see page 167



Angled Quick-Fit MPO/MPOptimate drawer panel

FEATURES

- Accommodates up to 4 MPO/MPOptimate Quick-Fit cassettes
- High-End solution
- Fully integrated and retractable cable management bracket
- Allows for easy Move, Adds and Changes
- Angled style of panels provides additional cable management towards side area

Color: black (RAL 9005)



ORDERING INFORMATION

Description	Part Number
Modular MPO/MPOptimate drawer panel for 4 Quick-Fit cassettes, angled	1-1671436-1

Flush Quick-Fit MPO/MPOptimate drawer panel

FEATURES

- Accommodates up to 4 MPO/MPOptimate Quick-Fit cassettes
- High-End solution
- Fully integrated and retractable cable management bracket
- Allows for easy Move, Adds and Changes
- Flushmount

Color: black (RAL 9005)



ORDERING INFORMATION

Description	Part Number
Modular MPO/MPOptimate drawer panel for 4 Quick-Fit cassettes, flush	1-1671437-1

MPO/MPOptimate System

MPO/MPOptimate Panels & Accessories

Modular MPO/MPOptimate front plate for Quick-Fit cassettes

FEATURES

- Low cost solution
- Flush mount
- Front plate with no additional cable management
- Does accept copper and fiber in one panel

Color: black (RAL 9005)



ORDERING INFORMATION

Description	Part Number
Modular MPO/MPOptimate front plate	1-1671373-1

MPO/MPOptimate coupler Quick-Fit module

FEATURES

- Quick-Fit module with 6 x or 12 x MPO coupler
- Port number labeling and additional label strip included
- MPO coupler always used with on one side MPO male and other side MPO female connector

Color: black (RAL 9005)

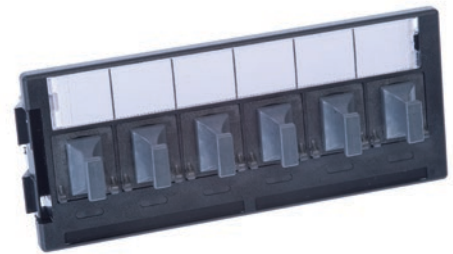

ORDERING INFORMATION

Description	Part Number
6 x MPO coupler module	1671200-1
12 x MPO coupler module	1711987-1

MPO/MPOptimate back cable manager

FEATURES

- 19", 1 U rear cable management bar
- Used for MPO front panels
- 3 depths available
- Applications include new installation and retrofit
- Rear or front of rack or cabinet mount

Color: black (RAL 9005)

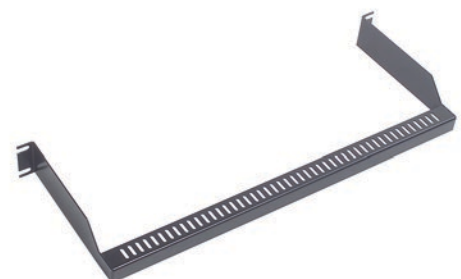

ORDERING INFORMATION

Description	Part Number
Cable management bar 100 mm depth	1711314-1
Cable management bar 175 mm depth	1711314-2
Cable management bar 275 mm depth	1711314-3

MPO/MPOOptimate System

MPO/MPOOptimate Panels & Accessories

MPO/MPOOptimate pull protection sleeve

FEATURES

- Re-usable installation pull and protection kit
- IP 67 protection
- Must be ordered separately
- One part number contains 1 x installation sleeve with end cap and 1 x pull sleeve with pull eye
- Does fit to:
 - 12 fiber MPO and MPOOptimate trunks with midi fan-out
 - 24 fiber MPO and MPOOptimate trunks with midi fan-out
 - 12 x MPO to LC or SC MPO and MPOOptimate trunk with midi fan-out
 - 48 fiber MPO and MPOOptimate trunks with midi fan-out (use 2055567-2)



Color: black (RAL 9005)

ORDERING INFORMATION

Description	Part Number
Protection sleeve kit for 12 and 24 fiber cables	2055567-1
Protection sleeve kit for 48 fiber cables	2055567-2

Hook & Loop Cable Ties

FEATURES

- Hook and loop ties
- No risk of damaging cables
- Releasable and reusable
- An order quantity of one equals one roll of 10 ties



ORDERING INFORMATION

Description	Part Number
Hook & Loop Tie 1" x 8" (10pcs.)	1375253-2
Hook & Loop Tie 1" x 12" (10pcs.)	1375254-2

Adhesive Foam Tape

FEATURES

- Protects cable jacket when mounted to panels
- No risk of damaging cables
- Dimensions: 15 mm x 1 mm
- 1 roll of 25 m

ORDERING INFORMATION

Description	Part Number
Foam tape 15 mm x 1 mm, 25 m roll	1671961-1

MPO/MPOptimate System

Q3000 Series MPO Fiber Panels

Q3000 Series Fiber Panels are the latest innovation in our High Fiber Count suite of products. The Q3000 Series provides a traditional fiber enclosure to accommodate applications with high density fiber terminations that require easy access to individual connectors and cable management within the panel. The Q3000 series can accommodate LC or MPO applications in singlemode and multimode fiber types

FEATURES

- Support IEEE 802.3ae, IEEE 802.3ba, IEEE 802.3z
- Exceed ANSI/TIA-568-C.3 and ISO 11801 Edition 2 cabling system requirements
- OM3, OM4, OS1 and OS2
- 19-Inch rack mountable
- Available in 1, 2, and 4U Chassis
- 48 Fiber (24 Duplex LC) LC-to-MPO Blade
- 192 Fiber (16 Port) MPO-to-MPO Blade

DIMENSIONS

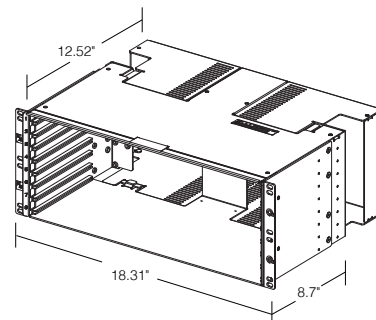
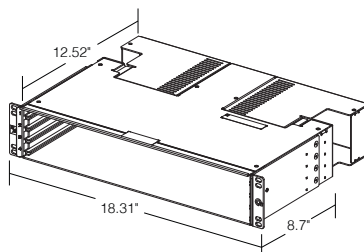
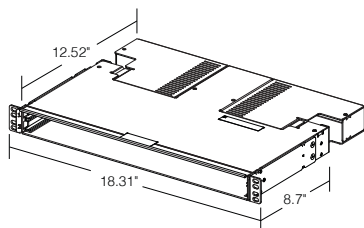

MPO/MPOptimate System

Q3000 Series MPO Fiber Panels

Q3200, Q3400 and Q3800 Chassis (unloaded)

Q3000 Series base chassis fit in any EIA/TIA 19-inch rack or cabinet. They can be loaded with any of the Q3000 or Q4000 series blades based on the application required. An optional door kit can be purchased to provide additional protection to the fiber patch cords exiting the panel.



ORDERING INFORMATION

Product Description		Part Number
Q3000 series chassis	Q3200; 1U (1.75" x 19" x 15"), accommodates 2 blades	QUCH-1RU
	Q3400; 2U (3.5" x 19" x 15"), accommodates 4 blades	QUCH-2RU
	Q3800; 4U (7" x 19" x 15"), accommodates 8 blades	QUCH-4RU
Front door kits	Q3200; 1U	QDR-1RU
	Q3400; 2U	QDR-2RU
	Q3800; 4U	QDR-4RU

Q3000 Blades

Q3000 Series blades are offered in LC-MPO, and MPO/MPO adapter only in singlemode, OM3 and OM4. These blades mount in either the Q4000 managed chassis to provide the end-user to upgrade the blade to Q4000 at a later date or into the standard Q3000 base chassis. Each blade is 1/2U in height (0.875 inches).



LC-MPO Blade



MPO-MPO Blade

ORDERING INFORMATION

Product Description		Part Number
LC to MPO; 24 Duplex LC ports (48 Fibers) distributed from 2 each 12 fiber MPO connectors	Singlemode ultra polish LC-MPO blade	QUFB-48FDLCMSMHR
	OM3 Multimode LC-MPO blade	QUFB-48FDLCMM3HR
MPO to MPO; 16 MPO ports with 12 Fibers each (192 fibers)	Singlemode MPO-MPO blade	QUFB-192FMPOMSMHR
	OM3/OM4 Multimode MPO-MPO blade	QUFB-192FMPOMMHR

MPO/MPOptimate System

MPO/MPOptimate Cleaning Tools

MPO/LC/SC/MT-RJ Cassette Cleaners



ORDERING INFORMATION

Description	Part Number
MTP/MPO with pins; Packaging: 1	1918802-1
1 Slot Reel Cleaner for MPO/LC/SC and MT-RJ; Packaging: 1	1918803-1
2 Slot reel cleaner for LC and SC; Packaging: 1	1918805-1
Cleaner Refill; Packaging: 6 rolls	1918806-1

MPO Coupler Cleaner



ORDERING INFORMATION

Description	Part Number
MPO IBC; Packaging: 1	1918809-1

LC/SC bulkhead cleaner



ORDERING INFORMATION

Description	Part Number
SC IBC (In Bulkhead Cleaner)	2064499-1
LC IBC (In Bulkhead Cleaner)	2064500-1
LC duplex IBC (In Bulkhead Cleaner)	2111664-1

2. MRJ21 System

MRJ21 XG Cassettes & Panels.....	28
MRJ21 XG Trunks & Fan-Outs.....	29
MRJ21 Cassettes & Panels.....	30
MRJ21 Trunks.....	32
MRJ21 Fan-Outs.....	34
MRJ21 Accessories	35

MRJ21 System

MRJ21 XG Cassettes & Panels

MRJ21 XG Quick-Fit Cassette 8 Port (10 Gb/s)

FEATURES

- Optimal for use in combination with UCP patch panels: plug & play deployment
- Compatible with MRJ21 XG cable assemblies for 10GbE performance
- Front side: 8 x RJ45 jack (2 rows of 4 jacks)
- Rear side: 2 x MRJ21 receptacle
- Factory terminated and tested solution
- For AMPTRAC version of MRJ21 XG Quick-Fit cassette please see page 131 in Chapter 8 B

Color: black (RAL 9005)



ORDERING INFORMATION

Description	Part Number
MRJ21 XG Quick-Fit cassette for 10GBase-T	2153115-1

MRJ21 XG 19" Patch Panel, 1U, straight

FEATURES

- Optimal for use in environments where high density is required
- Factory terminated and tested solution
- Compatible with MRJ21 XG cable assemblies for 10GbE performance
- Straight panel with either 24 or 48 ports on 1U
- For AMPTRAC version of MRJ21 XG 19" panel please see page 131 in Chapter 8 B

Color: black (RAL 9005)



ORDERING INFORMATION

Description	Part Number
Straight panel 1U for 10GbE; MRJ21 Plugs: 6; RJ-45 Ports: 24	2153041-1
Straight panel 1U for 10GbE; MRJ21 Plugs: 12; RJ-45 Ports: 48	2153046-1

MRJ21 System

MRJ21 XG Trunks & Fan-Outs

MRJ21 XG to MRJ21 XG trunks

FEATURES

- Friendly field installable 10 GbE solution
- Factory terminated and 100% tested solution
- Dense double blade connector with offset jackscrews for latching
- 16 pair shielded cable with AWG 26 solid conductors
- Available with LSZH or CMR sheath

Color: white



ORDERING INFORMATION

Description	Part Number
MRJ21 XG to MRJ21 XG, 10 Gb/s, 180°-180° back shell; LSZH sheath	Y-2153052-X
MRJ21 XG to MRJ21 XG, 10 Gb/s, 180°-45° back shell; LSZH sheath	Y-2153078-X
MRJ21 XG to MRJ21 XG, 10 Gb/s, 180°-180° back shell; CMR sheath	Y-2111521-X
MRJ21 XG to MRJ21 XG, 10 Gb/s, 180°-45° back shell; CMR sheath	Y-2111522-X

Y- -X	Length
0- -3	3 m
0- -5	5 m
1- -0	10 m
1- -5	15 m
2- -0	20 m
2- -5	25 m
3- -0	30 m
3- -5	35 m
4- -0	40 m

MRJ21 XG Fan-Out cable to multiple RJ-45 plugs (shielded)

FEATURES

- Friendly field installable 10 GbE solution
- Suitable for use in 3-connector models where 10 GbE application is required
- Factory terminated, 100% tested and serialized
- 16 pair, shielded, AWG 26 solid conductors
- MRJ21 to 4xRJ45 fan-out



ORDERING INFORMATION

Description	Part Number
MRJ21 to 4 RJ-45. 180° back shell; LSZH sheath	Y-2153230-X

Y- -X	Length
0- -3	3 m
0- -5	5 m
1- -0	10 m
1- -5	15 m
2- -0	20 m
2- -5	25 m
3- -0	30 m
3- -5	35 m
4- -0	40 m

MRJ21 System

MRJ21 Cassettes & Panels

MRJ21 Quick-Fit Cassette 12 port (1 Gb/s)

FEATURES

- Pre-terminated Quick-Fit cassette
- High Performance TP Cabling for guaranteed application performance
- High-density, small form factor connectivity
- Modular pluggable solution
- Automatic bonding by design



ORDERING INFORMATION

Description	Part Number
MRJ21 Quick-Fit cassette for 1000Base-T	1711970-1

MRJ21 angled patch panel (shielded and unshielded)

FEATURES

- High-performance TP cabling for guaranteed application performance
- High-density, small form factor copper connector interface
- Angled panel with 48 ports on 1U
- Factory terminated and tested solution
- Modular, pluggable solution
- Including grounding bolt

Color: black (RAL 9005)



ORDERING INFORMATION

Description	Part Number
Angled MRJ21 panel for 1000Base-T; MRJ21 Plugs: 8; RJ-45 Ports: 48	1-1671143-1

MRJ21 System

MRJ21 Cassettes & Panels

MRJ21 patch panel, 1U, straight (shielded)

FEATURES

- High performance TP cabling for guaranteed application performance
- High-density, small form factor copper connector interface
- Factory terminated and tested solution
- Straight panel with 24 or 48 ports on 1U
- Modular pluggable solution

Color: black (RAL 9005)



ORDERING INFORMATION

Description	Part Number
Standard straight panel for 1000Base-T; MRJ21 Plugs: 4; RJ-45 Ports: 24	1711944-1
Standard straight panel for 1000Base-T; MRJ21 Plugs: 8; RJ-45 Ports: 48	1777098-1

MRJ21 patch panel, 1U, straight (unshielded)

FEATURES

- High-performance TP cabling for guaranteed application performance
- High-density, small form factor copper connector interface
- Straight panel with 24 or 48 ports on 1U
- Factory terminated and tested solution
- Modular, pluggable solution

Color: black (RAL 9005)



ORDERING INFORMATION

Description	Part Number
Standard straight panel for 100Base-T; MRJ21 Plugs: 4; RJ-45 Ports: 48	1435965-1
Standard straight panel for 1000Base-T; MRJ21 Plugs: 8; RJ-45 Ports: 48	1435971-1
Standard straight panel for 1000Base-T; MRJ21 Plugs: 4; RJ-45 Ports: 24	1777029-1

MRJ21 System

MRJ21 Trunks

MRJ21 to MRJ21 cable assemblies (shielded)

FEATURES

- Friendly field installable 1 Gbs solution
- Enhanced screening and improved EMC
- Factory terminated and 100 % tested solution
- Dense double blade connector with offset jackscrews for latching
- 1.5 to 4 times the port density of 2 x 6 Stacked Mod Jack (RJ-45)
- 24 pair shielded cable with AWG 24 solid conductors

Color: white



Y- -X	Length
0- -5	5 m
1- -0	10 m
1- -5	15 m
2- -0	20 m
2- -5	25 m
3- -0	30 m
3- -5	35 m
4- -0	40 m
5- -0	50 m

ORDERING INFORMATION

Description	Part Number
MRJ21 to MRJ21, 180°-180° back shell; LSZH sheath	Y-1711758-X
MRJ21 to MRJ21, 180°-45° back shell; LSZH sheath	Y-1711774-X

MRJ21 to MRJ21 cable assemblies (unshielded)

FEATURES

- Factory terminated and tested solution
- Modular, pluggable solution
- Dense CHAMP style double blade design with offset jackscrew
- Contact layout and footprint for differential pairs creates reduced crosstalk and built-in compensation
- 1.5 to 4 times the port density of 2 x 6 Stacked Mod Jack (RJ-45)
- 3 times the port density of an RJ-21
- Jackscrew for positive latching and secure cable retention

Color: gray



Y- -X	Length
0- -5	5 m
1- -0	10 m
1- -5	15 m
2- -0	20 m
2- -5	25 m
3- -0	30 m
3- -5	35 m
4- -0	40 m
5- -0	50 m

ORDERING INFORMATION

Description	Part Number
MRJ21 to MRJ21, 180° back shell; CMR sheath	Y-2111366-X
MRJ21 to MRJ21, 180°-45° back shell; CMR sheath	Y-2111371-X

MRJ21 System

MRJ21 Trunks

MRJ21 to MRJ21 ultra slim cable assemblies (unshielded)

FEATURES

- Factory terminated and tested solution
- Modular, pluggable solution
- Dense CHAMP style double blade design with offset screw fixing
- Improves uptime and space efficiency on site
- 9,2mm cable OD
- 50-60% less cable mass in pathways and spaces than comparable 4-pair cabling
- 40% less weight than comparable 4-pair cabling
- Gigabit Ethernet Channel performance
- Jackscrews for positive latching and secure cable retention

Color: gray



Y- -X	Length
0- -2	2 m
0- -5	5 m
1- -0	10 m
1- -5	15 m
2- -0	20 m
2- -5	25 m
3- -0	30 m

ORDERING INFORMATION

Description	Part Number
MRJ21 to MRJ21 , Ultra slim, 180° back shell; CMR sheath	Y-2111367-X

* 30 meters application length restrictions apply

MRJ21 System

MRJ21 Fan-Outs

MRJ21 Fan-Out cable to multiple RJ-45 plugs (shielded)

FEATURES

- Friendly field installable 1 Gbs solution
- Enhanced screening and improved EMC
- Factory terminated and 100 % tested solution
- Dense double blade connector with offset jackscrews for latching
- 1.5 to 4 times the port density of 2 x 6 Stacked Mod Jack (RJ-45)
- 24 pair shielded cable with AWG 24 solid conductors



Color: white

Y- -X	Length
0- -5	5 m
1- -0	10 m
1- -5	15 m
2- -0	20 m
2- -5	25 m
3- -0	30 m
3- -5	35 m
4- -0	40 m
5- -0	50 m

ORDERING INFORMATION

Description	Part Number
MRJ21 to 6 RJ-45, 180° back shell; LSZH sheath	Y-1711789-X

MRJ21 Fan-Out cable to multiple RJ-45 plugs (unshielded)

FEATURES

- Factory terminated and tested solution
- MRJ21 to RJ45 hydra cable assemblies are wired so that all 4-pairs of the RJ45 are active for Gigabit Ethernet
- New ergonomic features for easier handling
- Modular, pluggable solution
- Dense CHAMP style double blade design with offset screw fixing
- Contact layout and footprint for differential pairs creates reduced crosstalk and built-in compensation
- 3 times the port density of an RJ-21
- Jackscrews for positive latching and secure cable retention
- Other lengths on request



Y- -X	Length
0- -5	5 m
1- -0	10 m
1- -5	15 m
2- -0	20 m
2- -5	25 m
3- -0	30 m
3- -5	35 m
4- -0	40 m
5- -0	50 m

Color: gray

ORDERING INFORMATION

Description	Part Number
MRJ21 to 6 RJ-45 for 1000Base-T, 180° back shell; CMR sheath	Y-2111370-X

MRJ21 System

MRJ21 Accessories

UCP Patch Panel Angled and Flushmount

Please refer to Chapter 4, page 50



MRJ21 cable guiding shelf

FEATURES

- 19" 4U shelf with 16 vertical slots
- Each slot accepts max. 8 stacks of MRJ21 cable assemblies
- Tie down capability at the back of the shelf

Color: black (RAL 9005)



ORDERING INFORMATION

Description	Part Number
MRJ21 cable guiding shelf	1671175-1

MRJ21 System

MRJ21 Accessories

MRJ21 Back cable manager

FEATURES

- 19", 1U rear cable management bar
- Used for MRJ21 or other high density copper or fiber optic panels
- Simple on site assembly
- Applications include new installation and retrofit
- Rear or front of rack or cabinet mount
- 4 depths available
- Tie-down capability on side brackets and back tie-down bar
- Tie-down bar is adjustable for horizontal or vertical cable strain relief

Color: black (RAL 9005)



ORDERING INFORMATION

Description	Part Number
Back cable manager 6" (150 mm) depth	1933352-1
Back cable manager 9" (230 mm) depth	1933352-2
Back cable manager 12" (300 mm) depth	1933352-3
Back cable manager 16" (400 mm) depth	1933352-4

3. Sigma-Link System

Sigma-Link Quick-Fit Class F _A	38
Sigma-Link Quick-Fit Class E _A	39
Sigma-Link Quick-Fit Class E.....	40
Sigma-Link Quick-Fit Panel.....	41
Sigma-Link Quick-Fit Accessories.....	42

Sigma-Link Quick-Fit System

Sigma-Link Quick-Fit Class F_A

Σ-Link Quick-Fit Cable Assemblies Class F_A - PL

FEATURES

- 24 ports per 1U, 6 port links
- Lengths 2-90m
- Factory assembled and 100% tested
- Bundle of 6 x 4 pair solid Category 7_A S/FTP cable (compliant to IEC 61156-5)
- LSFRZH sheath
- Three different types of far end termination available (housing, loose jacks, open cable ends)
- Housing-to-Housing version features integrated Plastic Optical Fiber (POF) for easy tracing of far end



Termination guidelines for Σ-Link Housing-to-Open end:

Install jacks with tool (AMP PN 1725150-1) according to instruction sheet 411-93013.
Use following jacks: AMP-TWIST 7_AS
(AMP PN 1711437-1 without dustcover or 1711441-1 with dustcover)

Note:

To achieve PL performance cable length should be > 2 m (2 connector model) according to ISO 11801 spec.

Y- -X	Length
0- -2	2 m
0- -5	5 m
1- -0	10 m
1- -5	15 m
2- -0	20 m
2- -5	25 m
3- -0	30 m
3- -5	35 m
4- -0	40 m
5- -0	50 m
6- -0	60 m
7- -0	70 m
8- -0	80 m
9- -0	90 m

ORDERING INFORMATION

Description	Part Number
Sigma-Link Cable Assembly Housing-to-Housing with POF Class F _A STP	Y-2153150-X
Sigma-Link Cable Assembly Housing-to-Jacks Class F _A STP	Y-2153151-X
Sigma-Link Cable Assembly Housing-to-Open End Class F _A STP	Y-2153152-X

Sigma-Link Quick-Fit System

Sigma-Link Quick-Fit Class E_A

Σ-Link Quick-Fit Cable Assemblies Class E_A - PL

FEATURES

- 24 ports per 1U, 6 port links
- Lengths 2-90m
- Factory assembled and 100% tested
- Bundle of 6 x 4 pair solid Category 7 F/FTP cable
- LSZH sheath
- Four different types of far end termination available (housing, loose jacks, open cable ends, loose plugs)
- Housing-to-Housing version features integrated Plastic Optical Fiber (POF) for easy tracing of far end
- Housing-to-Plugs version for service presentation in mobile Data Centers



Termination guidelines for Σ-Link Housing-to-Open end:

Install jacks with tool (AMP PN 1725150-1) according to instruction sheet 411-93016.

Use following jacks: AMP-TWIST 6_AS

(AMP PN 1711716-1 without dustcover or 1711592-1 with dustcover).

Note:

To achieve PL performance cable length should be > 2 m (2 connector model) according to ISO 11801 spec.

Y-	-X	Length
0-	-2	2 m
0-	-5	5 m
1-	-0	10 m
1-	-5	15 m
2-	-0*	20 m
2-	-5*	25 m
3-	-0*	30 m
3-	-5*	35 m
4-	-0*	40 m
5-	-0*	50 m
6-	-0*	60 m
7-	-0*	70 m
8-	-0*	80 m
9-	-0*	90 m

* not applicable for Housing-to-Plugs version

ORDERING INFORMATION

Description	Part Number
Sigma-Link Cable Assembly Housing-to-Housing with PoF Class E _A STP	Y-2153146-X
Sigma-Link Cable Assembly Housing-to-Jacks Class E _A STP	Y-2153147-X
Sigma-Link Cable Assembly Housing-to-Open End Class E _A STP	Y-2153148-X
Sigma-Link Cable Assembly Housing-to-Plugs Class E _A STP (Only available up to 15 m! Shorter lengths between increments on request.)	Y-2153149-X

Sigma-Link Quick-Fit System

Sigma-Link Quick-Fit Class E

Σ-Link Quick-Fit Cable Assemblies Class E - PL

FEATURES

- 24 ports per 1U, 6 port links
- Lengths 2-90m
- Factory assembled and 100% tested
- Bundle of 6 x 4 pair solid Category 6 U/UTP Cable
- LSZH Sheath
- Three different types of far end termination available (housing, loose jacks, open cable ends)
- Housing-to-Housing version features integrated Plastic Optical Fiber (POF) for easy tracing of far end



Termination guidelines for Σ-Link Housing-to-Open end:

Install jacks with tool (AMP PN 0-1725150-1) according to instruction sheet 408-8858
Use following jacks: Cat 6 RJ45 SL 110 connect
(AMP PN 0-1375055-X without dustcover or 0-1375187-X with dustcover)

Note:

To achieve PL performance cable length should be > 2 m (2 connector model) according to ISO 11801 spec.

Y- -X	Length
0- -2	2 m
0- -5	5 m
1- -0	10 m
1- -5	15 m
2- -0	20 m
2- -5	25 m
3- -0	30 m
3- -5	35 m
4- -0	40 m
5- -0	50 m
6- -0	60 m
7- -0	70 m
8- -0	80 m
9- -0	90 m

ORDERING INFORMATION

Description	Part Number
Sigma-Link Cable Assembly Housing-to-Housing with POF Class E UTP	Y-2153140-X
Sigma-Link Cable Assembly Housing-to-Jacks Class E UTP	Y-2153141-X
Sigma-Link Cable Assembly Housing-to-Open End Class E UTP	Y-2153142-X

Sigma-Link Quick-Fit System

Sigma-Link Quick-Fit Panel

UCP Patch Panel Angled and Flushmount

Please refer to Chapter 4, page 50



Sigma-Link Quick-Fit System

Sigma-Link Quick-Fit Accessories

Σ-Link identifier lamp

FEATURES

- Identifies the far end of the installed link
- Easy mounting on the housings



ORDERING INFORMATION

Description	Part Number
Sigma-Link identifier lamp; blue LED	1-1671330-1

4. Mixed Media Platform

NETpodium

Rack & Doors.....	44
Panels & Covers.....	45
Accessories.....	46

In-cabinet Management

Accessories.....	48
------------------	----

Universal Connectivity Platform

Patch Panels.....	50
Mounting Accessories.....	51
FiberGuide Mounting Accessories.....	52

Mixed Media Platform

NETpodium - Rack & Doors

NETpodium Rack

FEATURES

- Dimensions W x D x H = 1000 x 600 x 2200mm
- 45U
- 2 x 45U Cable managers included
- 2 large vertical cable ducts included
- Universal 19" Mounting rails according EIA 310

Color: black (RAL 9005)

ORDERING INFORMATION

Description	Part Number
NETpodium Cross-Connect Rack 1000x600	1-1671405-1



Front Doors

FEATURES

- Pair of non-perforated doors (left and right)
- Aluminium construction, lightweight yet rigid
- Easy mounting/removal from NETpodium frame, allowing agile installation
- Main Front Doors:
 - One pair covers complete front area of rack
 - Each door double-hinged and pivots both ways (for maximum access during MAC's or installation)
 - Supplied with locks, allowing for secure deployment
- Vertical Pathway Doors:
 - Cover the cords inside the lateral vertical patch bays (for increased physical cable protection)
 - Single hinged, pivoting on the outside edge of NETpodium frame

Color: black (RAL 9005)

ORDERING INFORMATION

Description	Part Number
Main Front Doors (Pair)	1-1671545-1
Vertical Pathway Doors (Pair)	2269019-1



Mixed Media Platform

NETpodium - Panels & Covers

Side Panel

FEATURES

- Solid aluminum side panel to cover the sides of the cabinet
- Easy to add and remove

Color: black (RAL 9005)

ORDERING INFORMATION

Description	Part Number
Side Panel Left	1-1671578-1
Side Panel Right	1-1671578-2

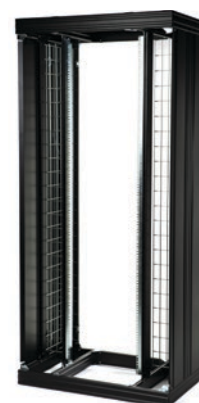

Back Panel

FEATURES

- Solid aluminum back panel to cover the backside of the cabinet
- Easy to remove

Color: black (RAL 9005)

ORDERING INFORMATION

Description	Part Number
Back Panel	1-1671579-1
Back Panel with backstrip	1-1671579-2



Top Cover

FEATURES

- Aluminum top panel with 4 knock-out access ports for optimal cabling access

Color: black (RAL 9005)

ORDERING INFORMATION

Description	Part Number
Top Cover	1-1671555-1



Bottom Cover

FEATURES

- Aluminum bottom panel to block airflow

Color: black (RAL 9005)

ORDERING INFORMATION

Description	Part Number
Bottom Cover	1-1671554-1



Mixed Media Platform

NETpodium - Accessories

Baying Kit

FEATURES

- Kit to be used to attach and secure two NETpodium racks side-by-side or back-to-back

Color: galvanized

ORDERING INFORMATION

Description	Part Number
Baying Kit (12 pcs)	1-1671587-1



Overhead Cabling Pathway

FEATURES

- Overhead cabling pathway, including bend radius control for both balanced copper cabling and fiber optic cabling
- A cost effective way of routing cords from one cabinet to an adjacent cabinet
- Dim holes: 185 x 175mm
- Max capacity = +/- 120 cables with 9mm OD

Color: black (RAL 9005)

ORDERING INFORMATION

Description	Part Number
Overhead Cabling Pathway	1-1671508-1



4U Pass Through Channel

FEATURES

- 4U pass through channel designed to fit at the bottom of a NETpodium rack
- Allows intra-cabinet patching inside the NETpodium rack
- Only fits in NETpodium rack

Color: black (RAL 9005)

ORDERING INFORMATION

Description	Part Number
Pass Through Channel	1671614-1



Mixed Media Platform

NETpodium - Accessories

FO Slack Storage Spools

FEATURES

- Provides overlength capacity for FO cords
- Enables the use of 1 length FO cords in a rack

Color: black (RAL 9005)



ORDERING INFORMATION

Description	Part Number
FO Slack Storage Spools (Left + Right)	1-1671610-1

NETpodium Copper Cable Dividing plate

FEATURES

- Designed for X-Connect patching to divide 2 and 4m length of copper cords

Color: black (RAL 9005)

ORDERING INFORMATION

Description	Part Number
NETpodium Copper Cable Dividing plate	1671933-1



NETpodium bracket for wire basket

FEATURES

- Bracket to be used onto the wire basket
- Accepts additional accessories

Color: galvanized

ORDERING INFORMATION

Description	Part Number
NETpodium bracket for wire basket (4pcs)	1671938-2



End Caps

FEATURES

- Cap to cover the aluminum profile

Color: black (RAL 9005)

ORDERING INFORMATION

Description	Part Number
End Cap (8pcs)	1-1671609-1



High-Density Front-Loading Cable Managers for Cabinets

FEATURES

- Offers bend radius (according to ISO/IES 11801:2002 table 25) and mechanical protection
- Rubber entry/exit retainers ensure cable captivity preventing accidental disturbance of patch cords
- Suitable for Twisted Pair & Fiber Optic patch cords
- Note: To get a left/right pair order the respective part number twice (higher MOQs may apply)!

Color: black (RAL 9005)

ORDERING INFORMATION

Description	Part Number
High-Density Front-Loading Cable Managers 1U	1671495-1
High-Density Front-Loading Cable Managers 2U	1671495-2
High-Density Front-Loading Cable Managers 4U	1671495-4
High-Density Front-Loading Cable Managers 6U	1671495-6
High-Density Front-Loading Cable Managers 15U	1-1671495-5



Horizontal Slack Storage Panel

FEATURES

- 4U storage panel to store copper overlength in a copper X-connect configuration
- Allows left or right cable entry
- Hinged access cover ensures accessibility and security of installed patch cords

Color: black (RAL 9005)

ORDERING INFORMATION

Description	Part Number
Horizontal Slack Storage Panel	1671711-1



2U Pass Through Duct

FEATURES

- 2U pass through duct
- Allows left to right side patching as well as front to back patching and intra-cabinet patching
- Hinged access cover ensures accessibility of installed Patch Cords

Color: black (RAL 9005)

ORDERING INFORMATION

Description	Part Number
2U pass through duct	1-1671080-2



Mixed Media Platform

In-Cabinet Management - Accessories

1U Blanking Plates

FEATURES

- 1U blind panels
- Angled version to fill gaps between angled panels
- Straight version to fill gaps between straight panels or active equipment

Color: black (RAL 9005)



ORDERING INFORMATION

Description	Part Number
1 U blind panel angled	1671113-1
1 U blind panel straight	1671113-2

1 U Cable Management Panels 19"

FEATURES

- Panels mount to the front of 19" racks and provide for the orderly dressing and routing of cable assemblies
- Various ring lengths available
- 1 U high

Note: PN 1859160-1 is optimized to be used with panels incl. Quick-Fit modules



ORDERING INFORMATION

Description	Part Number
4 rings; light gray (RAL 7035); Height: 1 U; Ring length: 60 mm	9-101019-0
5 rings; black (RAL 9005); Height: 1 U; Ring length: 95 mm	558329-1
5 rings black (RAL 9005)	1859160-1

Mounting Hardware

FEATURES

- Hardware to attach panels and equipment to racks and cabinets
- Packaging quantity: 50 and 500

ORDERING INFORMATION

Description	Part Number
Screw set (50 pcs) M6	1671147-1
Screw set (500 pcs) M6	1671147-2
Screw set (500 pcs) M6 + cage nuts	1671147-4
Screw set (50 pcs) M6 + cage nuts	1671147-3



M6



M6 + Cage Nuts

Mixed Media Platform

Universal Connectivity Platform - Patch Panels

UCP Patch Panel Angled and Flushmount

FEATURES

- 19" 1U unloaded modular patch panel with support for 4 Quick-Fit Modules
- Angled and flush style panels available
- Modular, rear cable management for both horizontal Copper and Fiber cables
- Accepts Pre-terminated Cu or FO cassettes or Field-terminated Copper modules
- Including grounding bolt

Color: black (RAL 9005)

ORDERING INFORMATION

Description	Part Number
UCP Patch Panel 1U Angled	1-1671590-1
UCP Patch Panel 1U Flush	1-1671594-1
UCP Patch Panel 1U Angled w/o cable bracket	0-1671590-1
UCP Patch Panel 2U Angled w/o cable bracket	0-1671590-2
UCP Patch Panel 4U Angled w/o cable bracket	0-1671590-4



Xtra-U Fiber Panel with Cable Management

FEATURES

- 3U Bracket to support a single MPOptimate Quick-Fit cassette
- Management rings to store and protect excess MPOptimate trunk cables
- Including grounding bolt

Color: black (RAL 9005)

ORDERING INFORMATION

Description	Part Number
Xtra-U Fiber Panel with Cable Management (for standard racks)	1-1671547-1
Xtra-U Fiber Panel with Cable Management (for NETpodium rack)	1-1671550-1



Xtra-U Copper Panel without Cable Management

FEATURES

- 3U Bracket to support a single Copper Quick-Fit cassette or module
- Including grounding bolt

Color: black (RAL 9005)

ORDERING INFORMATION

Description	Part Number
Xtra-U Copper Panel without Cable Management (for standard racks)	1-1671548-1
Xtra-U Copper Panel without Cable Management (for NETpodium rack)	1-1671551-1



Mixed Media Platform

Universal Connectivity Platform - Mounting Accessories

Xtra-U Vertical Panel Mounting Brackets

FEATURES

- Bracket set to install a 1U 19" panel vertically outside of the 19" area of a cabinet/rack
- Available for 1U

Color: galvanized



ORDERING INFORMATION

Description	Part Number
Xtra-U Vertical Panel Mounting Brackets (2 pcs) (for standard racks)	1-1671549-1
Xtra-U Vertical Panel Mounting Brackets (2 pcs) (for NETpodium rack)	1-1671552-1



Xtra-U Subfloor Panel Holder Kit

FEATURES

- Bracket set to install 19" panels in the false floor area underneath cabinets/racks
- Suitable for Copper and Fiber installations
- Allows up to 630mm gap between support pillars
- Attachable to support pillars with round or square cross-section (diameters from 14 to 30mm)
- Available for 1, 2 or 4U

Color: galvanized



ORDERING INFORMATION

Description	Part Number
Xtra-U Subfloor Panel Holder Kit 1U	1671189-1
Xtra-U Subfloor Panel Holder Kit 2U	1671189-2
Xtra-U Subfloor Panel Holder Kit 4U	1671189-4



Xtra-U Aerial Panel Holder Kit for Wire Mesh Cable Trays

FEATURES

- Universal bracket for installing 19" patch panels above cabinets /racks
- Can be attached to wire mesh cable trays
- 2U and 4U version available

Color: galvanized

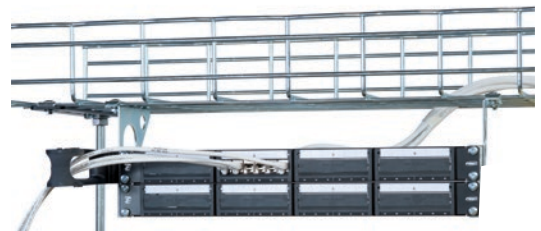

ORDERING INFORMATION

Description	Part Number
Xtra-U Aerial Panel Holder Kit (2U) for Wire Mesh Trays	1-1671603-1
Xtra-U Aerial Panel Holder Kit (4U) for Wire Mesh Trays	1-1671603-2



Mixed Media Platform

Universal Connectivity Platform - FiberGuide Mounting Accessories

Xtra-U FiberGuide System Quick-Fit adaptor

FEATURES:

- Fits to FGS products, s.a. 4" Express Exits, 4 x 4 Downspouts
- Can accommodate up to 2 Quick-Fit MPO cassettes or modules
- Integrated strain relief feature
- Including grounding bolt

Color: galvanized



ORDERING INFORMATION

Description	Part Number
Xtra-U FGS Quick-Fit adaptor	1-1671618-1

Xtra-U Aerial Panel Holder Kit for FiberGuide System

FEATURES

- Universal bracket for installing 19" patch panels above cabinets /racks
- Can be attached to FGS channels (4 x 4, 4 x 6 and 4 x 12)
- 2U and 4U version available

Color: galvanized



ORDERING INFORMATION

Description	Part Number
Xtra-U Aerial Panel Holder Kit (2U) for FGS	1-1671603-3
Xtra-U Aerial Panel Holder Kit (4U) for FGS	1-1671603-4

5. FiberGuide System

2x2 System	54
4x4 System.....	56
2x6 System.....	62
4x6 System.....	65
4x12 System	70
4x24 System.....	72
LighTrax to FGS adaptors.....	79
Express Exit™ Family.....	80
System Support Kits	82

FiberGuide System

2" H x 2" W - Fittings

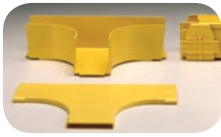

Horizontal T
(FGS-MHTA-C)



Horizontal Cross
(FGS-MHXP-C)

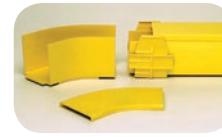

45° Horizontal Elbow
(FGS-MH4A-C)



90° Horizontal Elbow
(FGS-MH9A-C)



90° Extended
Horizontal Elbow
(FGS-MH9A-C-45/2)



45° Up Elbow
(FGS-MU4A-C)

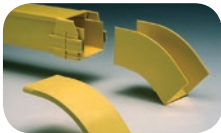

45° Down Elbow
(FGS-MD4A-C)



2x2 to 4x4
Straight Adapter
(FGS-MDSA-AC)



End Cap
(FGS-HMEC-C)

ORDERING INFORMATION

Description	Number of Junctions	Catalog Number
		Yellow System
2x2 fittings		
Horizontal T; <i>cover included</i>	3	FGS-MHTA-C
Horizontal cross; <i>cover and two 2x2 junctions included; two additional 2x2 junctions required (see p. 22)</i>	2+2	FGS-MHXP-C
45° horizontal elbow; <i>cover included</i>	2	FGS-MH4A-C
90° horizontal elbow; <i>cover included</i>	2	FGS-MH9A-C
90° extended horizontal elbow; <i>cover included; similar to two 45° horizontal elbows joined</i>	2	FGS-MH9A-C-45/2
45° up elbow; <i>cover included</i>	2	FGS-MU4A-C
90° up elbow; <i>cover included</i>	2	FGS-MU9A-C
45° down elbow; <i>cover included</i>	2	FGS-MD4A-C
90° down elbow; <i>cover included</i>	2	FGS-MD9A-C
2x2 conversions		
2x2 to 4x4 straight adapter; <i>cover included</i>	(1) 2x2, (1) 4x4	FGS-MDSA-AC
2x2 end cap		
End cap; <i>junction included</i>	--	FGS-HMEC-C

Black versions available

FiberGuide System

2" H x 2" W - Downspouts and Attachments



2x2 Standard Downspout
(FGS-MSDS-C)



2x2 Extended Downspout
(FGS-MDSP-C)

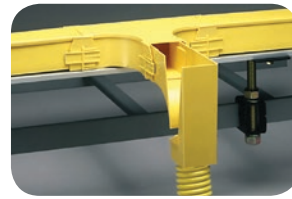

Extended Downspout
(FGS-KDH2-C shown attached to
2x2 FiberGuide system)



**Dual 7/8" Flex Tube
Attachment**
(FGS-KT03-C)

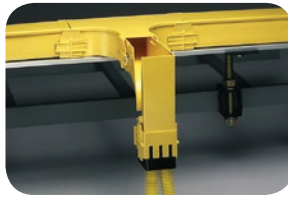

Dual 7/8" Flex Tube Attachment
(FGS-KT03-C shown attached
to downspout)

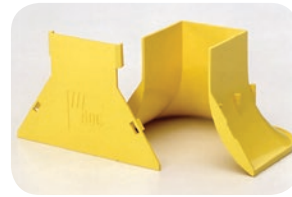

2x2 Trumpet Flare
(FGS-MTRM-C)

ORDERING INFORMATION

Description	Number of Junctions	Catalog Number
		Yellow System
2x2 downspouts		
Standard downspout; <i>cover included</i>	2	FGS-MSDS-C
Extended downspout; <i>cover included</i>	1	FGS-MDSP-C
Extended downspout; <i>cover and 2" flex tube, 2' long, included</i>	1	FGS-KDH2-C
Trumpet flare; <i>2x2 junction included</i>	-	FGS-MTRM-C
2x2 attachments		
2x2 flex tube attachment - 2" flex tube and a 2x2 junction included		
5' length	-	FGS-MEX1-C-5F
10' length	-	FGS-MEX1-C-10F
15' length	-	FGS-MEX1-C-15F
Dual 7/8" flex tube attachment - <i>two lengths of 7/8" flex tube and a 2x2 junction included</i>		
(2) 5' length	-	FGS-KT03-C
(2) 10' length	-	FGS-KT03-C-10F
(2) 15' length	-	FGS-KT03-C-15F
Flex tube clamp kit of 10; attaches 7/8" flex tube to rack	-	FGS-HSHC-10

Black versions available

FiberGuide System

2" H x 2" W - Straight Section and Junction

Straight Section

The 2x2 straight section is a U-shaped trough that provides a protective raceway for optical fibers. Available in 6-foot lengths, the straight section carries fibers horizontally throughout the system. It can also be installed vertically when routing around obstructions. A warning label indicating caution around fiber optic cable is included with each junction kit.



Horizontal Straight Section

ORDERING INFORMATION

Description	Catalog Number Yellow System
2x2 straight section; horizontal straight section; 6' long, cover included	FGS-MSHA-C

Black version available

Junction

The 2x2 junction is used for mechanically joining FiberGuide® sections. No tools are required for assembly.



Junction
(FGS-MJWR-C)

ORDERING INFORMATION

Description	Catalog Number Yellow System
2x2 junction	FGS-MJWR-C

Black version available

FiberGuide System

4" H x 4" W - Fittings

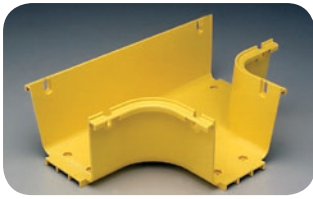

Horizontal T
(FGS-MHRT-A)



Horizontal Cross
(FGS-MHXP-A)



90° Horizontal Elbow
(FGS-MH9E-A)



90° Up Elbow
Metal Cover Included
(FGS-MU9E-A)



90° Down Elbow
(FGS-MD9E-A)



45° Horizontal Elbow
(FGS-MH4E-A)



45° Up Elbow
Metal Cover Included
(FGS-MU4E-A)



45° Down Elbow
(FGS-MD4E-A)



4x4 to 4x6 Straight Adapter
(FGS-MDSA-AB)



Expandable Straight Section
(FGS-MVAR-A)



Cut-in T
(FGS-MHIS-A)



Cut-in T Fixture
shown on straight section
(FGS-MHIS-JIG-A/B/F)



End Cap
(FGS-HMEC-A)

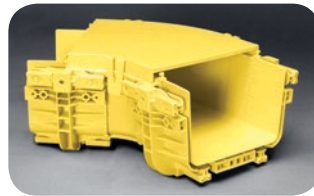

Snap-on Plastic Cover
(FGS-SH4E-A shown attached to 45°
horizontal elbow with junctions)

FiberGuide System

4" H x 4" W - Fittings

ORDERING INFORMATION

Description	Number of Junctions	Part Number	
		Yellow System	Yellow System Snap-on Cover
4x4 fittings			
Horizontal T	3	FGS-MHRT-A	FGS-SHRT-A
Horizontal cross	4	FGS-MHXP-A	FGS-SHXP-A
90° horizontal elbow	2	FGS-MH9E-A	FGS-SH9E-A
90° up elbow metal cover included	2	FGS-MU9E-A	FGS-SU9E-A
90° down elbow	2	FGS-MD9E-A	FGS-SD9E-A
45° horizontal elbow	2	FGS-MH4E-A	FGS-SH4E-A
45° up elbow metal cover included	2	FGS-MU4E-A	FGS-SU4E-A
45° down elbow	2	FGS-MD4E-A	FGS-SD4E-A
4x4 conversions			
4x4 to 4x6 straight adapter	(1) 4x4, (1) 4x6	FGS-MDSA-AB	FGS-SDSA-AB
4x4 expandable straight section	2	FGS-MVAR-A	-
4" Cut-in T assembly hardware included	-	FGS-MHIS-A	-
6" Cut-in T assembly hardware included	-	FGS-MHIS-B	-
12" Cut-in T assembly hardware included	-	FGS-MHIS-F	-
Cut-in T fixture	-	FGS-MHIS-JIG-A/B/F	-
4x4 end cap	-	FGS-HMEC-A	-

Black versions available

FiberGuide System

4" H x 4" W - Downspouts and Attachments



Downspout
(FGS-MDSP-A)



Cover for 4x4 Downspout
(FGS-MCDS-AB)



Extended Downspout
(FGS-MDSP-EX-A)
shown with and without cover)

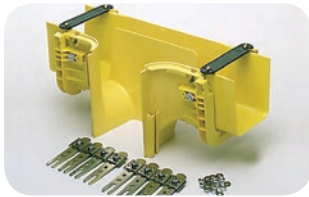

Insertable Downspout
(FGS-MDSP-A/I)



Trumpet Flare
(FGS-MTRM-A)



**Downspout Exit
Junction Kit**
(FGS-MJWR-A)



4x4/4x6 Downspout Insert
(FGS-HDSI-AB)



**4" Square to 2" Round Adapter
with Flex Tube**
(FGS-ASRI
requires FGS-MJWR-A
Junction Kit)



Dual 2" Flex Tube Attachment
(FGS-KT03-A)



Single 2" Flex Tube Attachment
(FGS-KT03-A1)



2" Quad Flex Tube Attachment
(FGS-KT03-A4)

FiberGuide System

4" H x 4" W - Downspouts and Attachments

An array of 4x4 downspout options are available to feed fiber from overhead straight sections into fiber optic equipment below.

ORDERING INFORMATION

Description	Number of Junctions	Part Number
		Yellow System
4x4 downspouts		
Downspout	2**	FGS-MDSP-A
Cover for 4x4 downspout	-	FGS-MCDS-AB
Extended downspout	2*	FGS-MDSP-EX-A
Cover for 4x4 extended downspout	-	FGS-MCDS-EX-AB
Insertable downspout	-	FGS-MDSP-A/I
Trumpet flare used on both 4x4 and 4x6 downspouts; no 4" junction kit required	-	FGS-MTRM-A
Downspout exit junction kit	-	FGS-MJWR-A
4x4/4x6 downspout; insert converts bottom of downspout to 2x2" without using 2" to 4" adapter, saving vertical space	-	FGS-HDSI-AB
4x4 attachments		
Square to 2" round adapter with flex tube; one 4x4 junction kit (FGS-MJWR-A) required to attach to a downspout drop		
5' length	1	FGS-ASRI-5F
10' length	1	FGS-ASRI-10F
15' length	1	FGS-ASRI-15F
Dual 2" flex tube attachment; no 4x4 junction kit required		
(2) 5' length	-	FGS-KT03-A
(2) 10' length	-	FGS-KT03-A10F
(2) 15' length	-	FGS-KT03-A15F
Single 2" flex tube attachment; no 4x4 junction kit required		
5' length	-	FGS-KT03-A1
10' length	-	FGS-KT03-A1-10F
15' length	-	FGS-KT03-A1-15F
Quad 2" flex tube attachment; no 4x4 junction kit required		
(4) 5' length	-	FGS-KT03-A4-5F
(4) 10' length	-	FGS-KT03-A4-10F
(4) 15' length	-	FGS-KT03-A4-15F
4x4 quad 7/8" flex tube attachment; no 4x4 junction kit required		
(4) 5' length	-	FGS-KT07-A4-5F
(4) 10' length	-	FGS-KT07-A4-10F
(4) 15' length	-	FGS-KT07-A4-15F

*A third junction is needed if drop is to a fitting or straight section.

**This drop junction must be a junction type FGS-MJWR-A, FGSB-MJWR-A.

Black versions available

FiberGuide System

4" H x 4" W - Straight Section and Snap-Fit™ Junction

Straight Section

The unique four-channel design of the 4x4 FiberGuide straight section allows the standard system to be attached to the support structure without the need to cut or drill any holes within the trough. This ensures that the patch cords will not come in contact with any screw heads or bolts, an important consideration in 4x4 systems where higher cable counts apply increased pressure on patch cords at the bottom of the trough.



**Horizontal
Straight Section**
(FGS-MSHS-A)



**Expandable
Straight Section**
(FGS-MVAR-A)



**Hinged Cover for
Horizontal Straight Section**
(FGS-MSNC-A)

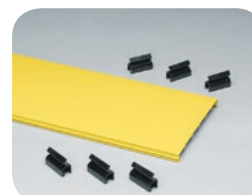

**Snap-On
Cover for Horizontal
Straight Section**
(FGS-MSSC-A)

ORDERING INFORMATION

Description	Part Number
	Yellow System
4x4 straight section	
Horizontal straight section; 6' long, cover sold separately	FGS-MSHS-A
Expandable straight section	FGS-MVAR-A
4x4 accessories	
Hinged cover kit for horizontal straight section; includes three mounting hinges and three clips	FGS-MSNC-A
Snap-on cover kit for horizontal straight section; includes six capture clips with mounting clasps	FGS-MSSC-A
Kit - 10 black capture clips	FGS-DHCP
Kit - 10 black capture clips and 10 hinges	FGS-DHHC (Yellow Hinge)

Black versions available

Snap-Fit™ Junction

The Snap-Fit™ junction assembly is available for the 4-inch FiberGuide system. The Snap-Fit junction is a completely tool-less junction. No additional tools are required for installation or removal. The junction exhibits superior holding force and accommodates support brackets. A warning label indicating caution around fiber optic cable is included with each junction kit.



Snap-Fit Junction
(FGS-MFAW-A)

ORDERING INFORMATION

Description	Part Number
	Yellow System
4x4 Snap-Fit™ junction	FGS-MFAW-A

Black version available

FiberGuide System

2" H x 6" W - Fittings, Downspouts and Attachments



2x6 to 2x2 Downspout
(FGS-MDSP-G)



Horizontal T
(FGS-MHRT-G)



Horizontal Cross
(FGS-MHXP-G)



90° Horizontal Elbow
(FGS-MH9E-G)



90° Down Elbow
(FGS-MD9E-G)



45° Horizontal Elbow
(FGS-MH4E-G)



45° Up Elbow
(FGS-MU4E-G)
(Metal Cover Included)



45° Down Elbow
(FGS-MD4E-G)



2x6 to 4x4 Adapter
(FGS-MDSA-GA)



2x6 to 4x6 Adapter
(FGS-MDSA-GB)



Trumpet Flare
(FGS-MTRM-G)

FiberGuide System

2" H x 6" W – Fittings, Downspouts and Attachments

ORDERING INFORMATION

Description	Number of Junctions	Part Number
		Yellow System
2x6 fittings		
Horizontal T	3	FGS-MHRT-G
Horizontal cross	4	FGS-MHXP-G
90° horizontal elbow	2	FGS-MH9E-G
90° down elbow	2	FGS-MD9E-G
45° horizontal elbow	2	FGS-MH4E-G
45° up elbow, metal cover included	2	FGS-MU4E-G
45° down elbow	2	FGS-MD4E-G
2x6 conversions		
2x6 to 4x4 adapter	(1) 2x6, (1) 4x4	FGS-MDSA-GA
2x6 to 4x6 adapter	(1) 2x6, (1) 4x6	FGS-MDSA-GB
2x6 downspouts		
2x6 to 2x2 downspout	2	FGS-MDSP-G
Trumpet flare	-	FGS-MTRM-G
2x6 attachments		
Dual 2" flex tube attachment	-	FGS-KT03-G-5F
2x6 end cap	-	FGS-HMEC-G

Black versions available

Low-Profile Express Exit™

Designed for low-ceiling or height restricted environments, the Express Exit™ for the 2x6 FiberGuide system extends only two inches above the straight section sidewall. The Express Exit accommodates up to 150 (3 mm) patch cords, includes removable rear cable guides for additional cable management, and features a 2x2 exit opening. It is designed specifically for the 2x6 FiberGuide system and should not be used on any other FiberGuide system.



Express Exit
(FGS-MEXP-LP-G)

ORDERING INFORMATION

Description	Part Number
	Yellow System
Low-Profile Express Exit™ (designed exclusively for the 2x6 system) <i>Base, cover, mounting hardware, and support bracket included</i>	FGS-MEXP-LP-G

Black version available

FiberGuide System

2" H x 6" W – Straight Section and Junction

Straight Section

The unique four-channel design of the 2x6 FiberGuide straight section allows the standard system to be attached to the support structure without the need to cut or drill any holes within the trough. This ensures that the patch cords will not come in contact with any screw heads or bolts.



Straight Section
(FGS-MSHS-G)

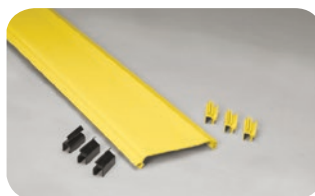

Hinged Cover Kit for Horizontal Straight Section
(FGS-MSNC-B/G)

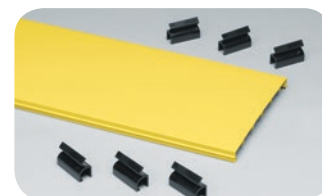

6-inch Snap-on Cover
(FGS-MSSC-B/G)

ORDERING INFORMATION

Description	Part Number
	Yellow System
2x6 straight section; horizontal straight section; 6' long, cover sold separately	FGS-MSHS-G
2x6 accessories	
2x6 hinged cover kit for horizontal straight section; three mounting hinges and three clips included	FGS-MSNC-B/G
6-inch snap-on cover kit for horizontal straight section; six capture clips with mounting clasps included	FGS-MSSC-B/G
Kit-10 black capture clips	FGS-DHCP

Black versions available

Junction

The one-piece junction employs factory-installed set screws to assure strength and durability. No cutting or drilling of the components is required for assembly. A warning label indicating caution around fiber optic cable is included with each junction kit.



2x6 Junction
(FGS-JUNC-G)

ORDERING INFORMATION

Description	Part Number
	Yellow System
2x6 junction	FGS-JUNC-G

Black version available

FiberGuide System

4" H x 6" W - Fittings

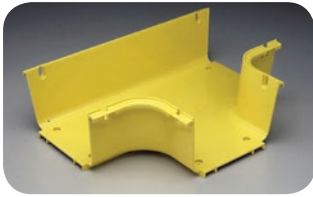

Horizontal T
(FGS-MHRT-B)



Horizontal Cross
(FGS-MHXP-B)



90° Horizontal Elbow
(FGS-MH9E-B)



90° Up Elbow
Cover Included
(FGS-MU9E-B)



90° Down Elbow
(FGS-MD9E-B)



45° Horizontal Elbow
(FGS-MH4E-B)



45° Up Elbow
Cover Included
(FGS-MU4E-B)



45° Down Elbow
(FGS-MD4E-B)



4x4 to 4x6 Straight Adapter
(FGS-MDSA-AB)



Expandable
Straight Section
(FGS-MVAR-B)



6" Cut-in T
(FGS-MHIS-B)



Cut-in T Fixture
(FGS-MHIS-JIG-A/B/F shown on
a straight section)



4x12 to Single 4x6 Adapter
(FGS-MDSA-FB)
(Cover: FGS-SDSA-FB)



End Cap
(FGS-HMEC-B)



Snap-on Plastic Cover
(FGS-SH4E-B shown attached
to 45° horizontal elbow
with junctions)

FiberGuide System

4" H x 6" W - Fittings

ORDERING INFORMATION

Description	Number of Junctions	Part Number	
		Yellow System	Yellow System Snap-on Cover
4x6 fittings			
Horizontal T	3	FGS-MHRT-B	FGS-SHRT-B
Horizontal cross	4	FGS-MHXP-B	FGS-SHXP-B
90° horizontal elbow	2	FGS-MH9E-B	FGS-SH9E-B
90° up elbow metal cover included	2	FGS-MU9E-B	-
90° down elbow	2	FGS-MD9E-B	FGS-SD9E-B
45° horizontal elbow	2	FGS-MH4E-B	FGS-SH4E-B
45° up elbow metal cover included	2	FGS-MU4E-B	FGS-SU4E-B
45° down elbow	2	FGS-MD4E-B	FGS-SD4E-B
4x6 conversions			
4x4 to 4x6 straight adapter	(1) 4x4, (1) 4x6	FGS-MDSA-AB	FGS-SDSA-AB
4x12 to single 4x6 adapter	-	FGS-MDSA-FB	FGS-SDSA-FB
4x6 expandable straight section	2	FGS-MVAR-B	-
4" Cut-in T; assembly hardware included	-	FGS-MHIS-A	-
6" Cut-in T; assembly hardware included	-	FGS-MHIS-B	-
12" Cut-in T; assembly hardware included	-	FGS-MHIS-F	-
Cut-in T fixture	-	FGS-MHIS-JIG-A/B/F	-
4x6 end cap	-	FGS-HMEC-B	-

Black versions available

FiberGuide System

4" H x 6" W - Downspouts and Attachments



Downspout
(FGS-MDSP-B)



Cover for 4x6 Downspout
(FGS-MCDS-AB)



Extended Downspout
(FGS-MDSP-EX-B shown with
and without cover)



Insertable Downspout
(FGS-MDSP-B/I)



Dual Downspout
(FGS-MDSP-2B)

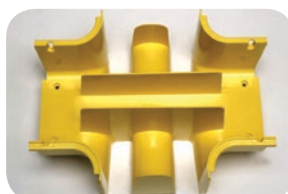

Dual Downspout with Divider
(FGS-MDSP-2B-IMP)



**Trumpet Flare Kit for 4x6
Dual Downspout**
(FGS-MTRM-2B)



**Trumpet Flare Kit for Dual
Downspout with Divider**
(FGS-MTRM-2B-IMP)



**Single 2" Flex Tube
Attachment**
(FGS-KT03-A1)



Trumpet Flare Kit
(FGS-MTRM-A shown attached
to downspout)



4x4/4x6 Downspout Insert
(FGS-HDSI-AB)

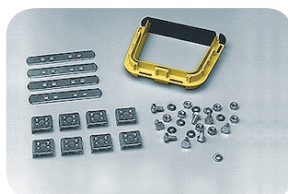

Downspout Exit Junction Kit
(FGS-MJWR-A)



**4" Square to 2" Round
Adapter with Flex Tube**
(FGS-ASRI requires
FGS-MJWR-A junction kit)



Dual 2" Flex Tube Attachment
(FGS-KT03-A)



**2" Quad Flex
Flex Tube Attachment**
(FGS-KT03-A4)

FiberGuide System

4" H x 6" W - Downspouts and Attachments

4x6 downspouts and attachments feed fiber from overhead straight sections into fiber optic equipment below. All 4x6 downspouts feature 4-inch exits and attach to the 4-inch x 4-inch attachments listed below.

ORDERING INFORMATION

Description	Number of Junctions	Part Number
		Yellow System
4x6 downspouts		
Downspout <i>Note: If a trumpet flare is required use a 4x4 flare (FGS-MTRM-A)</i>	2*	FGS-MDSP-B
Cover for 4x6 downspout and dual downspout	-	FGS-MCDS-AB**
Extended downspout	2	FGS-MDSP-EX-B
Cover for 4x6 extended downspout	-	FGS-MCDS-EX-AB
Insertable downspout	-	FGS-MDSP-B/I
Dual drop downspout	2*	FGS-MDSP-2B
Trumpet flare for dual drop downspout (kit of 2 FGS-MTRM-A)	-	FGS-MTRM-2B
Dual drop downspout with divider	2	FGS-MDSP-2B-IMP
Trumpet flare for dual drop downspout with divider (kit of 2)		FGS-MTRM-2B-IMP
Junction for downspout exit		FGS-MJWR-A
4x4/4x6 downspout insert; <i>converts bottom of downspout to 2x2 without using 2" to 4" adapter, saving vertical space</i>		FGS-HDSI-AB
4x4 Trumpet flare; used on exits of 4x4 and 4x6 downspouts — <i>no 4" junction kit required</i>		FGS-MTRM-A
4x6 Trumpet flare		FGS-MTRM-B
4x6 attachments		
4x4 square to 2" round adapter with flex tube; <i>one 4x4 junction kit (FGS-MJWR-A) required to attach to a downspout drop</i>		
5' length	1	FGS-ASRI-5F
10' length	1	FGS-ASRI-10F
15' length	1	FGS-ASRI-15F
4x4 dual 2" flex tube attachment; <i>no 4x4 junction kit required</i>		
(2) 5' length	-	FGS-KT03-A
(2) 10' length	-	FGS-KT03-A10F
(2) 15' length	-	FGS-KT03-A15F
4x4 single 2" flex tube attachment; <i>no 4x4 junction kit required</i>		
5' length	-	FGS-KT03-A1
10' length	-	FGS-KT03-A1-10F
15' length	-	FGS-KT03-A1-15F
4x4 quad 2" flex tube attachment; <i>no 4x4 junction kit required</i>		
(4) 5' length	-	FGS-KT03-A4-5F
(4) 10' length	-	FGS-KT03-A4-10F
(4) 15' length	-	FGS-KT03-A4-15F
4x4 quad 7/8" flex tube attachment; <i>no 4x4 junction kit required</i>		
(4) 5' length	-	FGS-KT07-A4-5F
(4) 10' length	-	FGS-KT07-A4-10F
(4) 15' length	-	FGS-KT07-A4-15F

*A 4x4 junction is needed to drop to a fitting or a straight section.
This drop junction must be a junction type FGS-MJWR-A or FGSB-MJWR-A.
**Dual downspout requires two covers.

Black versions available

FiberGuide System

4" H x 6" W - Straight Section and Junction

Straight Section

The unique four-channel design of the 4x6 FiberGuide straight section allows the standard system to be attached to the support structure without the need to cut or drill any holes within the trough. This ensures that the patch cords will not come in contact with any screw heads or bolts, an important consideration in 4x6 systems where higher cable counts apply increased pressure on patch cords at the bottom of the trough.



Horizontal Straight Section
(FGS-MSHS-B)



Expandable Straight Section
(FGS-MVAR-B)



Hinged Cover Kit
for Horizontal Straight Section
(FGS-MSNC-B/G)

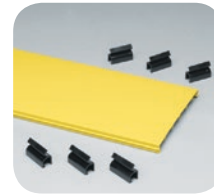

6" Snap-on Cover
for Horizontal Straight Section
(FGS-MSSC-B/G)

ORDERING INFORMATION

Description	Part Number
	Yellow System
4x6 straight sections	
Horizontal straight section; 6' long, cover sold separately	FGS-MSHS-B
Expandable straight section	FGS-MVAR-B
Slack storage straight section	FGS-MSHS-STOR-B
4x6 accessories	
Hinged cover kit for horizontal straight section; includes three mounting hinges and three clips	FGS-MSNC-B/G
6" snap-on cover kit for horizontal straight section; includes six capture clips with mounting clasps	FGS-MSSC-B/G
Kit - 10 black capture clips	FGS-DHCP
Kit - 10 black capture clips and 10 hinges	FGS-DHHC (Yellow Hinge)

Black versions available

Snap-Fit™ Junction

The Snap-Fit™ junction assembly is available for the 6-inch FiberGuide system. The new junction is a completely tool-less junction. No additional tools are required for installation or removal. The Snap-Fit Junction exhibits superior holding force and accommodates support brackets. A warning label indicating caution around fiber optic cable is included with each junction kit.



Snap-Fit Junction
(FGS-MFAW-B)

ORDERING INFORMATION

Description	Part Number
	Yellow System
4x6 Snap-fit junction	FGS-MFAW-B

Black version available

FiberGuide System

4" H x 12" W - Fittings



Horizontal T
(FGS-MHRT-F)

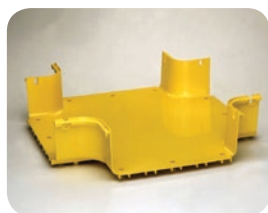

Horizontal Cross
(FGS-MHXP-F)

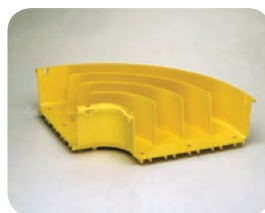

90° Horizontal Elbow
(FGS-MH9E-F)



90° Down Elbow
(FGS-MD9E-F)



45° Horizontal Elbow
(FGS-MH4E-F)



45° Up Elbow
(FGS-MU4E-F)



45° Down Elbow
(FGS-MD4E-F)



Horizontal T with Single 6" Exit
(FGS-MHRT-F/B)



Horizontal Cross with Two 6" Exits
(FGS-MHXP-B/F)



4x12 to Dual 4x6 Adapter
(FGS-MDSA-F2B)



4x12 to Single 4x6 Adapter
(FGS-MDSA-FB)



4x12 to 4x6 Adapter - Right
(FGS-MDSA-FB-R)

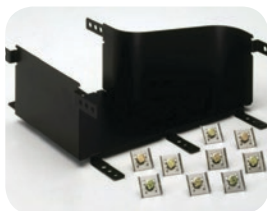

4x12 to 4x6 Adapter - Left
(FGS-MDSA-FB-L)



End Cap
(FGS-HMEC-F)



Expandable Straight Section
(FGS-MVAR-F)



12" Cut-in T
(FGS-MHIS-F)



Cut-in T Fixture
(FGS-MHIS-JIG-A/B/F shown on a straight section)



Snap-on Cover
(FGS-SH4E-F shown separate)



Snap-on Cover Installation



Snap-on Cover
(FGS-SH4E-F shown installed)

FiberGuide System

4" H x 12" W – Fittings

ORDERING INFORMATION

Description	Number of Junctions	Part Number	
		Yellow System	Yellow System Snap-on Cover
4x12 fittings			
Horizontal T	3	FGS-MHRT-F	FGS-SHRT-F
Horizontal cross	4	FGS-MHXP-F	FGS-SHXP-F
90° horizontal elbow	2	FGS-MH9E-F	FGS-SH9E-F
90° down elbow	2	FGS-MD9E-F	FGS-SD9E-F
45° horizontal elbow	2	FGS-MH4E-F	FGS-SH4E-F
45° up elbow, metal cover included	2	FGS-MU4E-F	FGS-SU4E-F
45° down elbow	2	FGS-MD4E-F	FGS-SD4E-F
Horizontal T with single 6" exit	(2) 4x12, (1) 4x6	FGS-MHRT-F/B	FGS-SHRT-F/B
Horizontal cross with two 6" exits	(2) 4x12, (2) 4x6	FGS-MHXP-B/F	FGS-SHXP-B/F
4x12 conversions			
4x12 to dual 4x6 adapter	(1) 4x12, (2) 4x6	FGS-MDSA-F2B	FGS-SDSA-F2B
4x12 to single 4x6 adapter	(1) 4x12, (1) 4x6	FGS-MDSA-FB	FGS-SDSA-FB
4x12 to 4x6 right adapter; <i>includes fastening hardware</i>		FGS-MDSA-FB-R	
Fixed metal cover for right adapter		FGS-VDSA-FB-R	
4x12 to 4x6 left adapter; <i>includes fastening hardware</i>		FGS-MDSA-FB-L	
Fixed metal cover for left adapter		FGS-VDSA-FB-L	
Expandable straight section	2	FGS-MVAR-F	-
4" Cut-in T; <i>assembly hardware included</i>	-	FGS-MHIS-A	-
6" Cut-in T; <i>assembly hardware included</i>	-	FGS-MHIS-B	-
12" Cut-in T; <i>assembly hardware included</i>	-	FGS-MHIS-F	-
Cut-in T fixture	-	FGS-MHIS-JIG-A/B/F	-
4x12 end cap		FGS-HMEC-F	
4x12 variable support locator kits for; <i>Each kit contains all necessary mounting hardware. Fitting sold separately.</i>			
FGS-MDSP-F (downspout)		FGS-MDSP-F-VS	
FGS-MHRT-F (horizontal T)		FGS-MHRT-F-VS	
FGS-MHXP-F (horizontal cross)		FGS-MHXP-F-VS	
FGS-MH9E-F (90° horizontal elbow)		FGS-MH9E-F-VS	
FGS-MHRT-F/B (horizontal T - 6"/12")		FGS-MHRT-F/B-VS	
FGS-MHXP-B/F (horizontal cross- 6"/12")		FGS-MHXP-B/F-VS	

Black versions available

FiberGuide System

4" H x 12" W – Downspouts and Attachments



Downspout
(FGS-MDSP-F)



Cover for 4x12 Downspout
(FGS-SDSP-F)



Trumpet Flare
(FGS-MTRM-F)



Downspout with Rear T
(FGS-MDRT-F)



Island T
(FGS-ISLAND-F)



Island T with Recessed Dividing Spool
(FGS-ISLAND3-F shown with 12" Junction, 90° Down Elbow and Trumpet Flare)



4x6 Dual 2" Flex Tube Attachment
(FGS-KT03-B)



4x6 Trumpet Flare Kit
(FGS-MTRM-B shown alone and attached to 4x12 Downspout)



4x12 to 4x4 Downspout Converter
(FGS-HDSI-F/D)

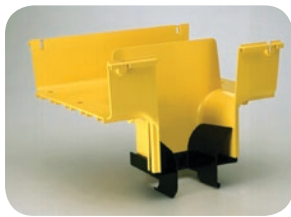

The FGS-HDSI-F/D attached to both the 4x12 downspout and the 4x4 slotted duct without the use of hardware

FiberGuide System

4" H x 12" W – Downspouts and Attachments

An array of 4x12 downspouts and attachments are available to feed fiber from overhead straight sections into fiber optic equipment below. The 4x12 downspout features a 4x6 exit and accepts the 4x6 exit attachments listed below.

ORDERING INFORMATION

Description	Number of Junctions	Yellow System Part Number
4x12 downspouts		
Downspout	2*	FGS-MDSP-F
Cover for 4x12 downspout	-	FGS-SDSP-F
Insertable downspout	-	FGS-MDSP-F/I
Trumpet flare	-	FGS-MTRM-F
Downspout with rear T	3*	FGS-MDRT-F
Island T with spool and factory installed trumpet flare	2	FGS-ISLAND-F
Island T with trumpet and dividing spool; <i>Variable Support Locator Kit included</i>	2	FGS-ISLAND-F-513
Island T with recessed dividing spool	3	FGS-ISLAND3-F
4x12 attachments		
4x6 dual 2" flex tube attachment		
5' length	-	FGS-KT03-B
10' length	-	FGS-KT03-B-10F
15' length	-	FGS-KT03-B-15F
4x6 trumpet flare kit; <i>used on 4x12 downspouts</i>		FGS-MTRM-B
4x12 to 4x4 downspout converter; <i>converts downspout opening to accept 4x4 slotted duct</i>	-	FGS-HDSI-F/D
4x12 to 2x2 downspout converter	-	FGS-HDSI-F/C

*An additional junction is needed if drop is to fitting or straight section. This 4x6 junction must be a junction type FGS-MFAW-B, FGSB-MFAW-B.

Black versions available

FiberGuide System

4" H x 12" W – Straight Section

The unique nine-channel design of the 4x12 FiberGuide straight section provides unmatched strength and allows the attachment of support structure without the need to cut or drill holes within the raceway. This ensures that the patch cords will not come in contact with any screw heads or bolts, an important consideration in 4x4, 4x6, and 4x12 systems where higher cable counts apply increased pressure on the patch cords at the bottom of the raceway.

The 4x12 system covers feature a snap-on design. This allows the cover to be used in environments with limited headroom. Two 3-foot cover sections come with each order, making it easy for one person to remove the covers. Each cover kit includes a tether kit. The straight section covers are designed to be placed over the 4x12 downspouts, speeding installation time by reducing the number of measurements and cuts that need to be made.



Horizontal Straight Section
(FGS-MSHS-F)

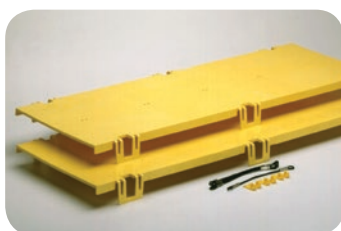

Horizontal Straight Section Cover
(FGS-MSSC-F includes two 3' Lengths and Tethering Hardware)



Expandable Straight Section
(FGS-MVAR-F)



12" Hinged Cover for Horizontal Straight Section
(FGS-MSNC-F)



Straight Section Cover in Tethered Position



Straight Section Cover Attached to Straight Section

ORDERING INFORMATION

Description	Part Number
	Yellow System
4x12 straight section	
Horizontal straight section; 6' long, cover sold separately	FGS-MSHS-F
Expandable straight section	FGS-MVAR-F
Slack storage straight section	FGS-MSHS-STOR-F
4x12 accessories	
Hinged cover kit for horizontal straight section; includes five mounting hinges and three clips	FGS-MSNC-F
Snap-on cover kit for horizontal straight section; includes 3' covers, optional tethering kit	FGS-MSSC-F
Kit - 10 black capture clips	FGS-DHCP
Kit - 10 black capture clips and 10 hinges	FGS-DHHC

Black versions available

FiberGuide System

4" H x 12" W – Snap-Fit™ Junction

The new Snap-Fit™ junction is available for the 12-inch FiberGuide system. The Snap-Fit junction is a completely tool-less junction. No additional tools are required for installation or removal. The Snap-Fit junction exhibits superior holding force and accommodates support brackets.

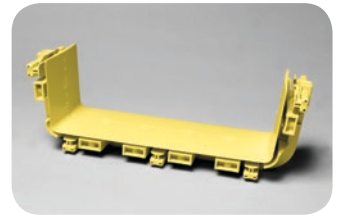

4x12 Snap-Fit Junction
(FGS-MFAW-F)

ORDERING INFORMATION

Description	Part Number
4x12 Snap-Fit™ junction	Yellow System
	FGS-MFAW-F

Black version available

FiberGuide System

4" H x 24" W - Fittings



End Cap
(FGS-HMEC-H)



Horizontal Cross with Dual 12" Exits
(FGS-MHXP-F/H)



Horizontal Cross
(FGS-MHXP-H)



45° Horizontal Elbow
(FGS-MH4E-H)



Horizontal T with Single 12" Exit
(FGS-MHRT-H/F)



12" Cut-in T
(FGS-MHIS-F/H)

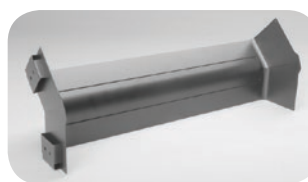

45° Down Elbow
(FGS-MD4E-H)



4x24 to 4x12 Adapter
(FGS-MDSA-HF)

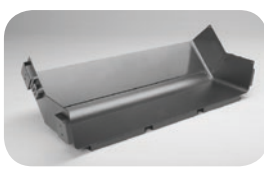

45° Up Elbow
(FGS-MU4E-H)

ORDERING INFORMATION

Description	Part Number
	Yellow System
4x24 fittings	
45° horizontal elbow	FGS-MH4E-H
Horizontal T with single 12" exit	FGS-MHRT-H/F
Horizontal T with three 24" exits	FGS-MHRT-H
Horizontal cross	FGS-MHXP-H
Horizontal cross with dual 12" exits	FGS-MHXP-F/H
45° up elbow	FGS-MU4E-H
45° down elbow	FGS-MD4E-H
4x24 conversions	
12" cut-in T for 4x24*	FGS-MHIS-F/H
6" cut-in T for 4x24*	FGS-MHIS-B/H
4" cut-in T for 4x24*	FGS-MHIS-A/H
4x24 to 4x12 adapter	FGS-MDSA-HF
4x24 end cap	FGS-HMEC-H

*Designed exclusively for the 4x24" system.

Black versions available

FiberGuide System

4" H x 24" W - Downspouts

4x24 downspouts and attachments feed fiber from overhead straight sections into fiber optic equipment below.

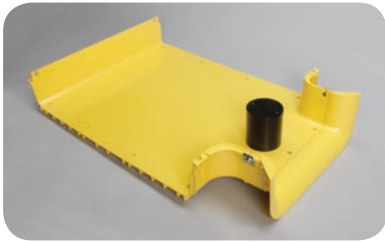

Island T with Single 12" Exit
(FGS-ISLAND-H/F)



Trumpet Flare
(FGS-MTRM-H)

ORDERING INFORMATION

Description	Part Number
	Yellow System
Island T with single 12" exit	FGS-ISLAND-H/F
Trumpet flare	FGS-MTRM-H

Black version available

FiberGuide System

4" H x 24" W - Straight Section, Snap-Fit™ Junctions and covers

Straight Section

The unique double wall channel design of the 4x24 straight section provides exceptional strength and durability for high fiber count applications and allows the standard system to be attached to the support structure without the need to cut or drill any holes within the trough. The six channel design ensures that the patch cords will not come in contact with any screw heads or bolts, an important consideration in 4x24 systems where higher cable counts apply increased pressure on patch cords at the bottom of the trough.

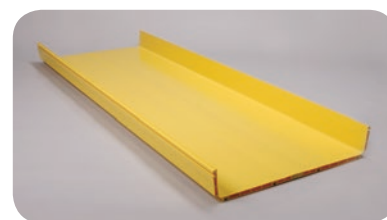

Straight Section
(FGS-MSHS-H)

ORDERING INFORMATION

Description	Part Number
4x24 straight section; horizontal straight section, 6' long	Yellow System FGS-MSHS-H

Black versions available

Snap-Fit Junction

The Snap-Fit™ Junction assembly is available for the 24-inch FiberGuide System. The Snap-Fit junction is a completely tool-less junction. No additional tools are required for installation or removal. The junction exhibits superior holding force and accommodates support brackets. A warning label is included with each junction kit.



Snap-Fit Junction
(FGS-MFAW-H)

ORDERING INFORMATION

Description	Part Number
4x24 Snap-Fit™ junction	Yellow System FGS-MFAW-H

Black versions available

Cover Kits

ORDERING INFORMATION

Description	Part Number
Cover for 4"x24"x6' straight section - FGS-MSHS-H	FGS-FSFC-H
Cover for 4"x24"horizontal tee with single 12" Exit - FGS-MHRT-H/F	FGS-FHRT-H/F
Cover for 4"x24"horizontal cross with dual 12" Exits - FGS-MHXP-F/H	FGS-FHXP-F/H
Cover for 4"x24"horizontal cross - FGS-MHXP-H	FGS-FHXP-H
Cover for 4"x24" 45° horizontal elbow - FGS-MH4E-H	FGS-FH4E-H
Cover for 4"x24"horizontal tee - FGS-MHRT-H	FGS-FHRT-H
Cover for 4"x24" 4° down elbow - FGS-MD4E-H	FGS-FD4E-H
Cover for 4"x24" to 4"x12" reducer - FGS-MDSA-HF	FGS-FDSA-HF

FiberGuide System

LighTrax to FGS adaptors

FiberGuide Adaptation kits

Adaptation kits make it possible to easily migrate from Lightrax to FiberGuide. They are easy to install and offer the opportunity to seamlessly expand your current raceway system.

Adaptation kits are available for the following sizes: 4x4", 4x6/4x8", 4x12/4x8" and 4x12".

ORDERING INFORMATION

Description	Part Number
Adapter Kit 4" to 4" (100 to 100mm)	FGS-FRH-4/4ADP
Adapter Kit FGS 4x6" to Lightrax 4x8" (150 to 200mm)	FGS-FRH-6/8ADP
Adapter Kit FGS 4x12" to Lightrax 4x8" (300 to 200mm)	FGS-FRH-12/8ADP
Adapter Kit 12" to 12" (300 to 300mm)	FGS-FRH-12/12ADP



Adapter Kit 4" to 4"



Adapter Kit FGS 4x6" to Lightrax 4x8"



Adapter Kit FGS 4x12" to Lightrax 4x8"

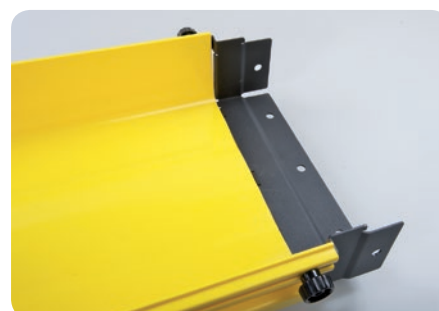

Adapter Kit 12" to 12"

FiberGuide System

Express Exit™ Family for 4x4, 4x6 and 4x12 Systems

ADC's patented* Express Exit™ family accommodates various raceway environments and applications. By simply securing an Express Exit to the sidewall of any 4x4, 4x6, 4x12, or 4x24 FiberGuide straight section, jumpers can be permanently or temporarily routed to fiber optic terminal (FOT) equipment below. No cutting of the FiberGuide system is required. Positioning a drop with a member of the Express Exit family greatly simplifies installation, protects the integrity of fibers already present in the raceway, and increases overall flexibility of the raceway system. All Express Exits guarantee 2-inch bend radius protection.

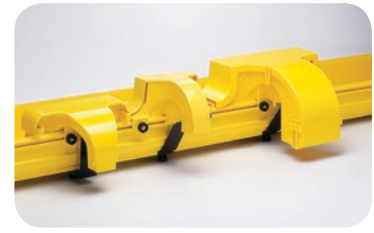

Express Exit Family

Express Exit Style	Height Above Sidewall	Exit Opening	3 mm Patch Cord Capacity	2 mm Patch Cord Capacity	Hinged Rear Cover	Exit Fin Inserts
2-Inch Express Exit	4"	2" x 2" ¹	150	350	No	No
Low-Profile Express Exit	2"	2" x 2" ¹	150	350	No	No
4-Inch Express Exit	4"	4" x 4" ²	300	700	Yes	Yes

¹Accepts all standard 2x2" attachments.

²Accepts all standard 4x4" attachments.

4-Inch Express Exit™

The 4-Inch Express Exit is designed to distribute and manage medium cable counts to FOT or ODF equipment. It features a 4-inch by 4-inch exit opening to accept all standard 4x4 downspout attachments and includes insertable exit fins and removable rear cable guides for additional cable management.

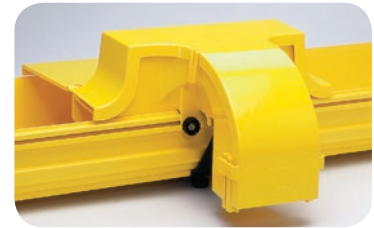

4-Inch Express Exit

ORDERING INFORMATION

Description	Part Number
	Yellow System
4-inch Express Exit™	
Express Exit; base, base cover, mounting hardware, support bracket, and exit inserts included	FGS-MEXP-E-A/B/F
4-inch accessories	
Express Exit rear hinged cover kit; one 4x4, 4x6, 4x12 rear hinged cover	FGS-MEXC-E-A/B/F
Express Exit rear hinged cover for 4x4 raceway	FGS-MEXC-E-A
Express Exit rear hinged cover for 4x6 raceway	FGS-MEXC-E-B
Express Exit rear hinged cover for 4x12 raceway	FGS-MEXC-E-F

*Other patents pending.

Black versions available

FiberGuide System

Express Exit™ Family for 4x4, 4x6 and 4x12 Systems

2-Inch Express Exit™

The 2-Inch Express Exit, ADC's initial offering in the Express Exit product family, accommodates up to 350, 2 mm patch cords. The patch cords are routed from a 4x4, 4x6, 4x12 or 4x24 straight section to FOT equipment below the raceway.

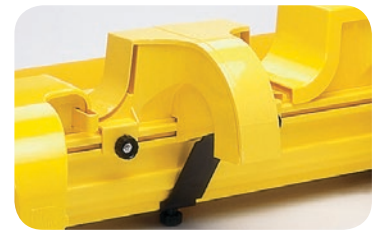

2-Inch Express Exit

ORDERING INFORMATION

Description	Part Number
2-Inch Express Exit™ ; base, base cover, mounting hardware and support bracket included	Yellow System FGS-MEXP-A/B/F

Black version available

Low-Profile Express Exit™

Designed for low-ceiling or height-restricted environments, the Low-Profile Express Exit features a front-removable cover and extends only 2 inches above the FiberGuide straight section sidewall. It also includes removable rear cable guides for additional cable management.

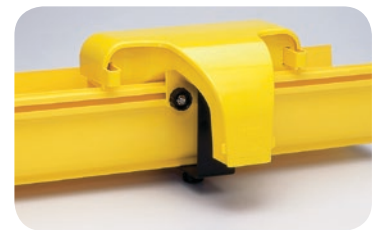

Low-Profile Express Exit

ORDERING INFORMATION

Description	Part Number
Low-Profile Express Exit™ ; base, base cover, mounting hardware and support bracket included	Yellow System FGS-MEXP-LP-A/B/F

Black version available

Attachments for 2-Inch Express Exit™ and Low-Profile Express Exit™

ORDERING INFORMATION

Description	Part Number
2x2 trumpet flare ; junction included	Yellow System FGS-MTRM-C
Single 2" flex tube attachment ; 2" flex tube and a 2x2 junction to attach to Express Exit unit included	
5' length	FGS-MEX1-C-5F
10' length	FGS-MEX1-C-10F
15' length	FGS-MEX1-C-15F
Dual 7/8" flex tube attachment ; two lengths of 7/8" flex tube and a 2" junction to attach to Express Exit unit included	
(2) 5' lengths	FGS-KT03-C
(2) 10' lengths	FGS-KT03-C-10F
(3) 15' lengths	FGS-KT03-C-15F

Black versions available

FiberGuide System

System Support Kits for 2x6, 4x4 and 4x6 Systems

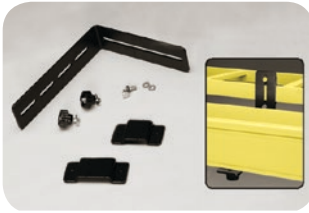

Ladder Rack Cantilever Support Bracket Kit
(FGS-HDLB-4)



L Bay Support Bracket Kit
(FGS-HLBK shown alone and attached to 4x4 FiberGuide)



New Threaded Rod Bracket kit
(FGS-HNTR-XX shown alone and attached to threaded rod)

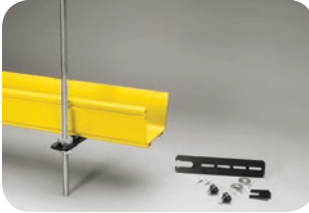

Existing Threaded Rod Bracket Kit
(FGS-HETR-XX shown alone and attached to threaded rod)



Modified New Threaded Rod Bracket Kit (FGS-HNTR-5/8-A shown alone and attached to threaded rod)

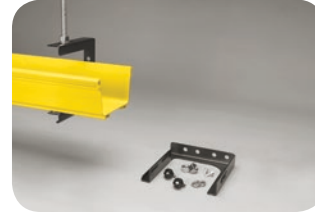

Top Support Low Profile C-bracket Kit
(FGS-HNTS-XX-LP)



Top Support C-Bracket Kit
(FGS-HNTS-XX)



Modified Existing Threaded Rod Bracket Kit
(FGS-HETR-5/8-A shown alone and attached to threaded rod)



Center Support Bracket Kit
(FGS-HTUB-XX)

ORDERING INFORMATION

Description	Part Number
2x6, 4x4, 4x6 system support kits	
Ladder rack cantilever support bracket kit	FGS-HDLB-3
L bay support bracket kit	FGS-HLBK
New threaded rod bracket kit; (XX = size: 1/2", 5/8", 12 mm, 14 mm, 16 mm, 18 mm)	FGS-HNTR-XX
Existing threaded rod bracket kit; (XX = size: 1/2", 5/8", 12 mm, 14 mm, 16 mm)	FGS-HETR-XX
Modified new threaded rod bracket kit; 5/8"	FGS-HNTR-5/8-A
Top support low-profile C-bracket kit; (XX = size: 1/2", 5/8", 12 mm, 14 mm, 16 mm)	FGS-HNTS-XX-LP
Top support C-bracket kit; (XX = size: 1/2", 5/8", 12 mm, 14 mm, 16 mm)	FGS-HNTS-XX
Modified existing threaded rod bracket kit; 5/8"	FGS-HETR-5/8-A
Center support bracket kit; (XX = size: 1/2", 5/8", 12 mm, 14 mm, 16 mm, 20 mm)	FGS-HTUB-XX
Digital cableway bracket kit; 305 mm (12")	FGS-HCBL-12
Digital cableway bracket kit; 381 mm (15")	FGS-HCBL-15
Ladder rack center support bracket kit	FGS-HNLR-AB
OMX frame center support bracket kit; 16 mm (.63")	FGS-HOMX-16MM
Under floor support bracket kit	FGS-HUFB-A

For custom brackets please contact your local Sales Representative

FiberGuide System

System Support Kits for 4x12 Systems



Existing Threaded Rod Trapeze Bracket Kit
(FGS-HETP-F-XX)



Trapeze Bracket Kit
(FGS-HNTP-F-XX)



Center Support Threaded Rod Bracket Kit
(FGS-HTUB-F-XX shown alone and attached to threaded rod)



Top Support Low-Profile Threaded Rod Bracket Kit
(FGS-HNTS-F-XX-LP shown alone and attached to threaded rod)



Top Support Threaded Rod Bracket Kit
(FGS-HNTS-F-XX)



New Threaded Rod Bracket Kit
(FGS-HNTR-F-XX)



Existing Threaded Rod Bracket Kit
(FGS-HETR-F-XX)

ORDERING INFORMATION

Description	Part Number
4x12 system support kits	
New ladder rack center support bracket kit	FGS-HNLR-F
Existing threaded rod trapeze bracket kit; (XX = size: 1/2", 5/8", 12 mm, 14 mm, 16 mm)	FGS-HETP-F-XX
Trapeze bracket kit; (XX = size: 1/2", 5/8", 12 mm, 14 mm, 16 mm)	FGS-HNTP-F-XX
Center support threaded rod bracket kit; (XX = size: 1/2", 5/8", 12 mm, 14 mm, 16 mm, 20 mm)	FGS-HTUB-F-XX
Top support low-profile threaded rod C-bracket kit; (XX = size: 1/2", 5/8", 12 mm, 14 mm, 16 mm)	FGS-HNTS-F-XX-LP
Top support threaded rod C-bracket kit; (XX = size: 1/2", 5/8", 12 mm, 14 mm, 16 mm)	FGS-HNTS-F-XX
New threaded rod bracket kit; (XX = size: 5/8", 14 mm, 16 mm, 18 mm)	FGS-HNTR-F-XX
Existing threaded rod bracket kit; (XX = size: 5/8", 14 mm, 16 mm)	FGS-HETR-F-XX

FiberGuide System

System Support Kits for 4x24 Systems



Variable Fitting Support Locator Kit - Horizontal Elbow
(FGS-MH4E-H-VS)

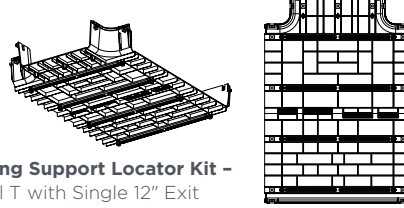

Variable Fitting Support Locator Kit - Horizontal T with Single 12" Exit
(FGS-MHRT-H/F-VS)

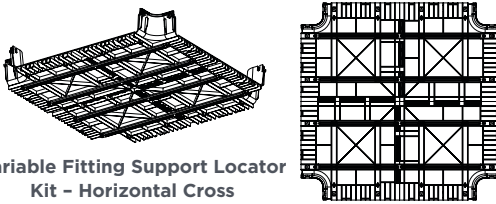

Variable Fitting Support Locator Kit - Horizontal Cross
(FGS-MHXP-H-VS)

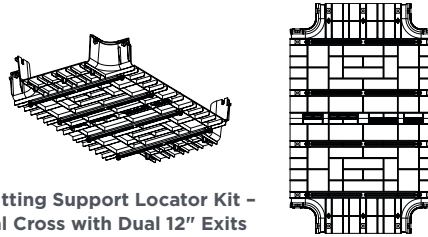

Variable Fitting Support Locator Kit - Horizontal Cross with Dual 12" Exits
(FGS-MHXP-F/H-VS)

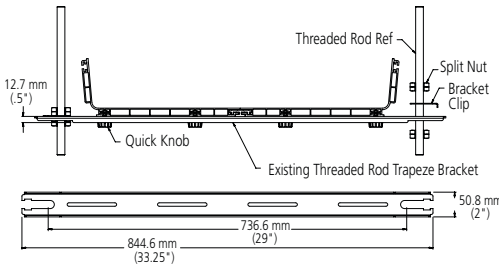

Existing 5/8" Threaded Rod Trapeze Bracket Kit
(FGS-HETP-H-5/8)

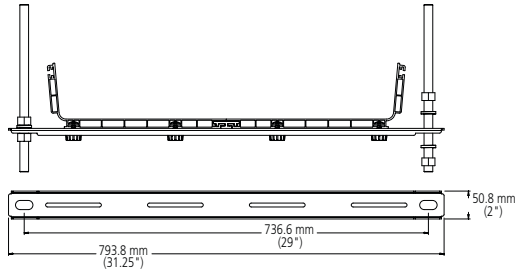

New 5/8" Threaded Rod Trapeze Bracket Kit
(FGS-HNTP-H-5/8)

ORDERING INFORMATION

Description	Part Number
4x24 System Support Kits	
Variable fitting support Locator kit for;	
Horizontal elbow	FGS-MH4E-H-VS
Horizontal T with single 12" exit	FGS-MHRT-H/F-VS
Horizontal cross	FGS-MHXP-H-VS
Horizontal cross with dual 12" exits	FGS-MHXP-F/H-VS
Threaded rod trapeze bracket kit for;	
Existing; 5/8"	FGS-HETP-H-5/8
New; 5/8"	FGS-HNTP-H-5/8

6. Storage Area Management (SAM)

Optical Cable Management, Simplified!	86
Under-chassis Enclosure & Adaptor Plates	87
Hydra Cable Assemblies	88
Far-end Panel Equipment	89
Trunk Cable Assemblies	90

Storage Area Management (SAM)

Optical Cable Management, Simplified!

Your data center is managing more information than ever. This is the driving force behind the need for more efficient and effective storage solutions. The increasing complexity of managing a large quantity of devices and data is escalating the cost of software and services, and is drawing most of the IT community's attention. The physical layer drives much of the complexity associated with installing SAN systems, and many of the impediments associated with these implementations.

There are a number of challenges with SAN cabling at the physical layer. High-density port groupings, the sheer volume of patch cords, moves, adds, and changes, and the ports themselves—installing and tracking the actual devices and cables connecting them, can all prove to be difficult. Plus, space is at a premium in most data centers; many have narrow cabinets or four post racks with inadequate cable management space.

TE's Storage Area Management (SAM) Solution for network infrastructures is designed to reduce the bulkiness of cabling and connectors in the data center by up to 80% and enable high-density deployment with fewer costly cabinet or infrastructure upgrades. SAM can help you save time, reduce costs, maximize efficiency, and open up much needed space in your data center. It takes the complexity out of cable management, and optimizes the performance of your data center floor space, racks and electronics.

De-clutter your racks for a highly organized, eco-friendly network infrastructure. SAM delivers operational efficiency to Storage Area Network (SAN) cabling and can help customers:

- Reduce SAN switch cabling volume by up to 80%
- Implement high-density deployment with fewer cabinet or infrastructure upgrades
- Reduce space requirements by managing up to 768 fiber ports within 2 rack units
- Minimize footprint—no additional front vertical, side, or horizontal cable management devices
- Deploy in narrow cabinets or racks and limited space environments
- Minimize cable mass and slack management using linecard-optimized hydra assemblies
- Easily access ports
- Maintain unobstructed linecard maintenance
- Achieve simplified scalability
- Organize with pre-labeled ports
- Speed up deployment and reduce connection errors with color-coded and keyed connections
- Simplify installation, upgrades and migration with dedicated linecard kits
- Improve operational response time
- Remove and redeploy linecards in several quick "clicks"
- Leverage the high density UCP cable management system with MPOptimate Quick-Fit cassettes
- Can be combined with other MPOptimate products in the channel within budget limits of the application



Storage Area Management (SAM)

Under-chassis Enclosure & Adaptor Plates

SAM Rack Mount Optical Fiber Enclosure

FEATURES

- Accepts 12 SAM adaptor plates
- Angled front face for improved visibility and cable management
- Rugged aluminum construction
- Internal guides to ease installation of trunk assemblies
- Adjustable front and rear mounting brackets included
- Panel labelling on rear to simplify location and documentation
- Pre-loaded with 12 blank plates



ORDERING INFORMATION

Description	Part Number
Rack Mount Patch Enclosure, 2U MPO SECURE	1553761-1

SAM MPO Adaptor Plates

FEATURES

- Adaptor counts match 16, 32, 48 and 64-port blades
- Color-coded keying on adaptors minimize risk of improper mating (keying on hydra side only—trunk side is not keyed)
- Port numbering matches blades
- Robust screw-in mounting system
- Accepts Multi Mode and Single Mode assemblies



ORDERING INFORMATION

Description	Part Number
16-Port blade (2 x MPO secure coupler)	2193050-1
32-Port blade (4 x MPO secure coupler)	2193051-1
48-Port blade (6 x MPO secure coupler)	2193052-1
64-Port blade (8 x MPO secure coupler)	2193016-1
Adaptor Plate Blank with 2 Cable Management rings	2111481-1

Storage Area Management (SAM)

Hydra Cable Assemblies

SAM Hydra Cable Assemblies

FEATURES

- 8-Port/16-fiber assemblies
- Length optimized for minimum slack
- SECURE MPO or MPOptimate connectors feature color coded keying for proper mating
- Overmolded LSZH cables
- Uniboot universal pitch LC connectors
- Individually labelled legs



ORDERING INFORMATION

Description	Port Label	MPO Color	Part Number MPO OS2	Part Number MPOptimate OM4
Hydra Cable Assembly for 16-Port & 32-Port blade	0-7	green	2160323-1	2160322-1
Hydra Cable Assembly for 16-Port & 32-Port blade	8-15	orange	2160325-1	2160324-1
Hydra Cable Assembly for 32-Port blade	16-23	green	2160323-2	2160322-2
Hydra Cable Assembly for 32-Port blade	24-31	orange	2160325-2	2160324-2
Hydra Cable Assembly for 48-Port blade	0-7	red	2160317-1	2160503-1
Hydra Cable Assembly for 48-Port blade	8-15	yellow	2160319-1	2160318-1
Hydra Cable Assembly for 48-Port blade	16-23	blue	2160321-1	2160320-1
Hydra Cable Assembly for 48-Port blade	24-31	red	2160317-2	2160503-2
Hydra Cable Assembly for 48-Port blade	32-39	yellow	2160319-2	2160318-2
Hydra Cable Assembly for 48-Port blade	40-47	blue	2160321-2	2160320-2
Hydra Cable Assembly for 64-Port blade	0-7	orange	2160386-1	2160385-1
Hydra Cable Assembly for 64-Port blade	8-15	slate	2160388-1	2160387-1
Hydra Cable Assembly for 64-Port blade	16-23	aqua	2160390-1	2160389-1
Hydra Cable Assembly for 64-Port blade	24-31	violet	2160392-1	2160391-1
Hydra Cable Assembly for 64-Port blade	32-39	orange	2160386-2	2160385-2
Hydra Cable Assembly for 64-Port blade	40-47	slate	2160388-2	2160387-2
Hydra Cable Assembly for 64-Port blade	48-55	aqua	2160390-2	2160389-2
Hydra Cable Assembly for 64-Port blade	56-63	violet	2160392-2	2160391-2

Storage Area Management (SAM)

Far-End Panel Equipment

SAM Far-End MPO/MPOptimate Quick-Fit cassettes

FEATURES

- 8 port (16 fiber) cassette to replicate 8 SFP ports on director blade
- Rear side: 1 x MPO (to accept one MPO trunk assembly)
Front side: 4 x LC Quad (to accept eight standard LC duplex assemblies)
- Maintains same port identity and labelling scheme as the hydra assemblies (including 8 pre-numbered port labels)
- To be used in UCP panels



ORDERING INFORMATION

Description	Part Number
MPOptimate OM4 Quick-Fit cassette	2160270-3
MPO OS2 Quick-Fit cassette	2160270-2

UCP Patch Panel Angled and Flushmount

Please refer to Chapter 4, page 50



Storage Area Management (SAM)

Trunk Cable Assemblies

SAM MPO/MPOptimate Trunk Cable Assemblies

FEATURES

- 24-fiber assemblies (16 active when mated to hydras) provide an upgrade path to 40 and 100 GbE
- Mate with SAM adaptor plates and SAM Quick-Fit cassettes
- Non-keyed MPO interface
- LSZH rated, indoor outdoor loose tube cable
- Pre-tested and ready to install
- The trunks are equipped with midi fan-out and 3.8mm round cable MPO tails (1.4mtr)
- All tails are protected with transparent protection sleeve



ORDERING INFORMATION

Description	Part Number
MPOptimate OM4	Y-2160301-X
MPO OS2	Y-2160302-X

Y- X	Length	Y- X	Length	Y- X	Length	Y- X	Length	Y- X	Length	Y- X	Length	Y- X	Length	Y- X	Length
0- -2	2 m	1- -3	13 m	2- -4	24 m	3- -5	35 m	4- -6	46 m	5- -7	57 m	6- -8	68 m	7- -9	79 m
0- -3	3 m	1- -4	14 m	2- -5	25 m	3- -6	36 m	4- -7	47 m	5- -8	58 m	6- -9	69 m	8- -0	80 m
0- -4	4 m	1- -5	15 m	2- -6	26 m	3- -7	37 m	4- -8	48 m	5- -9	59 m	7- -0	70 m	8- -1	81 m
0- -5	5 m	1- -6	16 m	2- -7	27 m	3- -8	38 m	4- -9	49 m	6- -0	60 m	7- -1	71 m	8- -2	82 m
0- -6	6 m	1- -7	17 m	2- -8	28 m	3- -9	39 m	5- -0	50 m	6- -1	61 m	7- -2	72 m	8- -3	83 m
0- -7	7 m	1- -8	18 m	2- -9	29 m	4- -0	40 m	5- -1	51 m	6- -2	62 m	7- -3	73 m	8- -4	84 m
0- -8	8 m	1- -9	19 m	3- -0	30 m	4- -1	41 m	5- -2	52 m	6- -3	63 m	7- -4	74 m	8- -5	85 m
0- -9	9 m	2- -0	20 m	3- -1	31 m	4- -2	42 m	5- -3	53 m	6- -4	64 m	7- -5	75 m	8- -6	86 m
1- -0	10 m	2- -1	21 m	3- -2	32 m	4- -3	43 m	5- -4	54 m	6- -5	65 m	7- -6	76 m	8- -7	87 m
1- -1	11 m	2- -2	22 m	3- -3	33 m	4- -4	44 m	5- -5	55 m	6- -6	66 m	7- -7	77 m	8- -8	88 m
1- -2	12 m	2- -3	23 m	3- -4	34 m	4- -5	45 m	5- -6	56 m	6- -7	67 m	7- -8	78 m	8- -9	89 m

7. Core VSM System

Management Panels	92
Copper Solution.....	93
Fiber Solution.....	95

Core VSM

Management Panels

Rack Mount Quick-Fit Panel

FEATURES

- Accepts up to 9 Quick-Fit modules
- 3U
- Including cable support bars with tie down options and Fiber Optic tail over length

Color: Black (RAL 9005) and galvanised finish

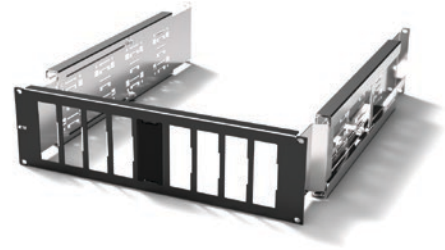

ORDERING INFORMATION

Description	Part Number
Rack Mount Quick-Fit Panel	1671907-1

Cable Management Tray

FEATURES

- Optimized to replace Cisco Nexus 7010 switch cable manager
- Provides vertical patch cord guiding

Color: Black (RAL 9005)



ORDERING INFORMATION

Description	Part Number
Cable Management Tray for Cisco Nexus 7010	1671633-1

RJ-45 to MRJ21 Quick-Fit Cassettes (1 or 10 Gb/s)

For RJ-45 copper management please use our MRJ21 Quick-Fit cassettes:

- for 10 GbE (XG) see page 26



- for 1 GbE see page 28



MRJ21 to MRJ21 shielded cable assemblies (1 or 10 Gb/s)

For RJ-45 copper management please use our MRJ21 trunk cable assemblies:

- for 10 GbE (XG) see page 27



- for 1 GbE see page 30



Category 6_A S/FTP Patch Cord RJ-45

FEATURES

- Exceeds Category 6_A performance suitable for 10 Gb/s data transmission
- Category 7 S/FTP stranded cable
- LSZH sheath
- Color-matched snagless boots
- Universal B-wiring
- Specially engineered patch cord length allows one length for all patch cords in a rack, reducing inventory holding costs and increasing flexibility for MACs



ORDERING INFORMATION

Description	Part Number
Patch Cord RJ45 Cat. 6 _A S/FTP, White	2153188-1

Category 5e F/UTP Patch Cord RJ-45

FEATURES

- Category 5e according to ISO/IEC 11801 and EN-50173-1
- 4 Pair stranded F/UTP cable
- LSZH sheath
- Color-matched snagless boots
- Universal wiring
- Specially engineered patch cord length allows one length for all patch cords in a rack, reducing inventory holding costs and increasing flexibility for MACs



ORDERING INFORMATION

Description	Part Number
Patch Cord RJ45 Cat 5E F/UTP, White	2153190-1

LC to MPO Quick-Fit cassettes or MPO to MPO modules

For LC or MPO fiber management please use our MPOptimate Quick-Fit cassettes and modules

- for MPO to LC Quick-Fit cassettes see page 4



- for MPO Coupler Quick-Fit modules see page 20



MPOptimate pre-terminated trunks

For LC or MPO fiber management please use our MPOptimate pre-terminated trunks on page 3



MPOptimate patch cords

For LC or MPO fiber management please use our MPOptimate pre-terminated patch cords on page 5



MPOptimate System LC patch cords

FEATURES

- Patch cords with optimized LC connectors
- Cable performance: OM4 XG_A or OM3 XG 10 Gb/s; LSZH construction
Optical performance: Attenuation ≤ 0.15 dB; RL ≥ 35 dB
- Specially engineered patch cord length allows one length for all patch cords in a rack, reducing inventory holding costs and increasing flexibility for MACs



ORDERING INFORMATION

Description	Part Number
Patch cord LC Duplex - LC Duplex; OM3 XG 10 Gb/s	2160506-1
Patch cord LC Duplex - LC Duplex; OM4 XG _A 10 Gb/s	2160506-2

MPOptimate Fan-Out cable assemblies

FEATURES

- Low loss transition from MPO to LC tails 2 mm
- Terminated with male MPOptimate connectors
- OM4 cable performance, LSZH construction
- Specially engineered fan-out cable length allows one length for all cable assemblies in a rack, reducing inventory holding costs and increasing flexibility for MACs



ORDERING INFORMATION

Description	Part Number
MPO male - LC Fan-out OM4 XG _A 10 Gb/s for 48 port blade	2160537-1
MPO male - LC Fan-out OM4 XG _A 10 Gb/s for 32 port blade	2160538-1

8. Quareo Physical Layer Management System

	Quareo Introduction.....	98
	Quareo Software.....	99
8A	Q4000 Managed Fiber Platform.....	102
	QHDEP High Density Equipment Panels.....	111
	Q2000 Copper Network Panels.....	122
8B	AMPTRAC Introduction.....	126
	AMPTRAC Analyzer.....	127
	AMPTRAC Scanning Module Cables.....	128
	AMPTRAC Fiber Platform.....	129
	AMPTRAC Fiber Patch Cords.....	130
	AMPTRAC Copper Platform.....	131
	AMPTRAC Copper Patch Cords.....	136
	AMPTRAC Sensor Strips.....	137
	Accessories.....	138

Quareo Physical Layer Management System

Introduction

Understanding Quareo Physical Layer Management

TE's Quareo physical layer management is an end-to-end solution, combining hardware and software elements to provide accurate visibility on the state of the physical network at all times. It enables easier, smarter network management for everyone from cable installers to network managers, strengthening physical security, boosting availability and providing real-time communication with network assets.

The Quareo physical layer management system leverages an innovative technology called connection point identification (CPID) to capture accurate information on the state of the network. This is done by incorporating chips on connectors throughout the network. Factory installed, these chips are programmed with all the pertinent information about a product, starting with the serial number. Once installed in the network, the product becomes fully discoverable, and the information can be accessed by a technician.

The Quareo physical layer management software captures data from the hardware and turns it into information that can be used to more effectively and efficiently manage the network. Field technicians and installers are armed with better, more accurate data, which reduces labor times and errors in service turn up and troubleshooting.

To learn more about Quareo physical layer management solutions, visit: www.te.com/Quareo

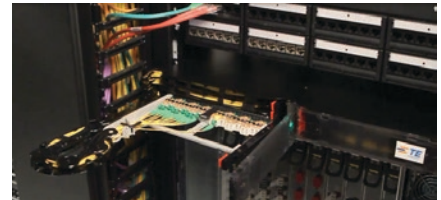

Quareo Physical Layer Management System

Quareo Software

Quareo Software

TE Connectivity's (TE) Quareo Software is a server software application designed to document and administer both passive and active network connectivity infrastructure. Quareo Software enables documentation of various levels of network components from existing brownfield infrastructure to TE's traditional and automated physical layer management solutions.

As part of the Quareo physical layer management system, Quareo Software enables immediate notification and response to changes in connectivity and automatically records the configurations of the physical layer cabling system and its devices with accurate documentation.

BENEFITS

- Accountability of assets by location and date
- Availability of assets and utilization is improved
- Reduced operational costs
- Best practice and regulatory requirements are more easily attained
- Network problems are more easily diagnosed and corrected
- Security is greatly enhanced
- Remote visibility of the physical layer
- DoD/DISA/JITC tested

FEATURES

The advanced system architecture allows full customization of the graphical user interface. Multiple users and multiple screens can be supported enhancing the usefulness of the system. Different color schemes are available that can be applied on a per user basis enhancing the user interface experience.

The graphical user interface supports multiple screens that visualize the network physical infrastructure in a detail not previously available. User access and profiles can be secured and controlled to a granular level based on responsibilities, roles and use cases.

The network infrastructure can be viewed in a classical tree hierarchy with branches nested below. Additionally, multiple drawings of a building can be added to the database and these can be allocated to different parts of the building, floor or room that is documented. These drawings can have network assets 'placed' and these assets remain dynamic within the drawing, allowing for information to be coordinated and viewed with a single click.

The network rack, cabinet or closet can be documented and visualized in full detail that shows the front and rear of any installed assets. Patch cables and their planned routing can be viewed including estimated minimum lengths.

Circuit traces can be viewed showing every element of the circuit path from switch port to end device and all intermediate steps.

Asset details are recorded and displayed in multiple screens and views. These details combine discovered and manually provided information. Asset utilization can be continually monitored* with charts/meters providing instantaneous and real time updates at a glance. All documented information can be searched in real time and items immediately displayed.

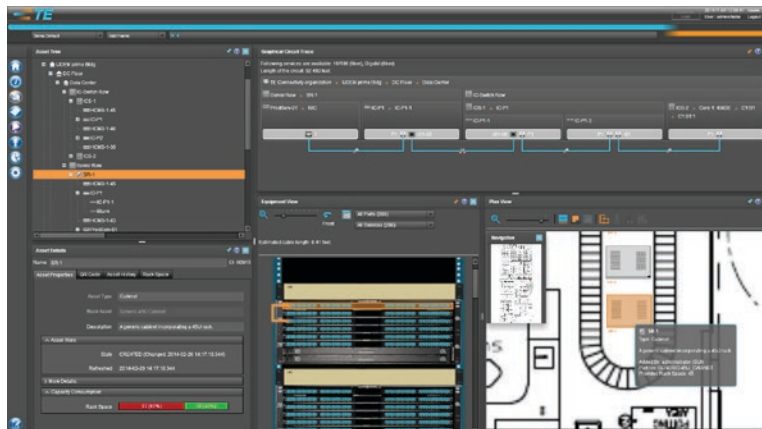

Quareo Physical Layer Management System

Quareo Software

Quareo Mobile

Download the Quareo mobile app for on-the-go physical network management. Use the app in conjunction with an active Quareo software system. Quareo mobile links with your Quareo software server to coordinate planned work orders and provide direct technician messaging and responses while enabling unprecedented management, details and control of the Information Transport System (ITS).

The Quareo mobile app is supported by select Android and Apple devices*. The app is available for download from iTunes* and Google Play* under the name 'ICM Mobile'.

Supported Android Handsets and Versions

- Google Nexus S, 4 and 5
- Samsung Galaxy S3, S4 and S5
- Android v4.3 and above

Supported Apple Devices and iOS Versions

- iPhone 4 and above (Works on iPod, iPad and iPhone devices supporting iOS 6 or greater)
- iOS 6 and above



BENEFITS

- On-screen guidance tips
- Port level details display
- Work order selection listing
- Work order synchronization
- Work order/LED activation controls
- Work order step selector/manager
- Detailed Work order steps:
 - Connect step
 - Disconnect step
 - Photo requirement step
 - GPS location step
 - Single end insertion/extraction steps
 - QRcode scan step
 - General step
- QR code scan and assist processes
- Switch port validation processes
- Auto-detect completion indicators
- Manual completion indicators
- Enhanced work order error messaging
- Response attachment handling
- Automatic status updates whilst performing managed work orders
- Incident response logging
- Events and alarms
- Guided setup and configuration validation
- QR coded asset management

*iTunes is a trademark of Apple Inc.

*Google Play is a service of Google Inc.

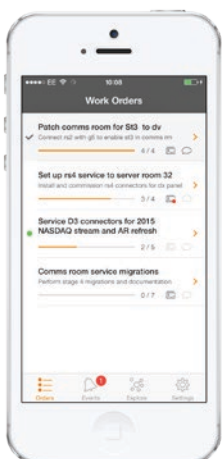

WO List

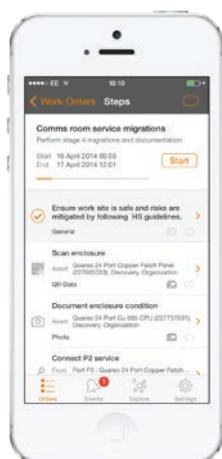

Step List



Step Detail



QR Scan

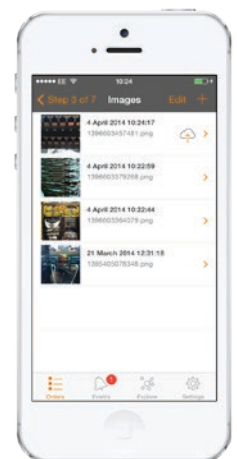

Attachments

Quareo Physical Layer Management System

Quareo Software

Ordering Information

QUAREO SOFTWARE QR CODES

Download the Quareo mobile app for on-the-go physical network management. Use the app in conjunction with an active Quareo software system. Quareo mobile links with your Quareo software server to coordinate planned work orders and provide direct technician messaging and responses while enabling unprecedented management, details and control of the Information Transport System (ITS).

Description	Part Number
Quareo QR Code Label Sheet - 5 sheets of 39 adhesive labels	2286081-1

QUAREO SOFTWARE

	Description	Part Number
Quareo Software is a per server license available in the following license blocks by managed-monitored port counts. Included with the initial license purchase is 1 year of annual maintenance and support as described below.	Quareo Software: Server and Port License: 1-7000 port	QS-SPL-7000
	Quareo Software: Server and Port License: 7001-20000 port	QS-SPL-20000
	Quareo Software: Server and Port License: 20001-50000 port	QS-SPL-50000
	Quareo Software: Server and Port License: 50001-Unlimited port	QS-SPL-UNLTD
Annual Maintenance The Quareo Software MLA covers updates and help desk support on an annual basis based on the port thresholds as shown in the following table. Technical Assistance Center (TAC) access includes patches, bug fixes as well as minor release revisions.	Quareo Software Maintenance: 1 year Maintenance Support 1-7000 port	QSM-1YRMS-7000
	Quareo Software Maintenance: 1 year Maintenance Support 7001-20000 port	QSM-1YRMS-20000
	Quareo Software Maintenance: 1 year Maintenance Support 20001-50000 port	QSM-1YRMS-50000
	Quareo Software Maintenance: 1 year Maintenance Support 50001-Unlimited port	QSM-1YRMS-UNLTD

NOTE: Major release revisions may contain new feature enhancements or modules and are subject to potential upgrade fees to existing licenses.

MINIMUM SERVER HARDWARE REQUIREMENTS:

- **Processor:** Dual core 2 GHz or higher (x64) processor required
- **Memory:** 8 GB
- **Available Disk Space:** 20 GB
- **Network connection:** 1 GB Network card

MICROSOFT® WINDOWS SERVER® 2008 R2

- Microsoft® Windows Server® 2012 R2
- Red Hat® Enterprise Linux® 6 - 64 bit
- CentOS-6 - 64 bit

DATABASE REQUIREMENTS

As part of the installation process, the following database platform will be installed on your server:

- PostgreSQL 9.1
- Apache™ Tomcat™ web server

OTHER REQUIREMENTS

- **Java Runtime Engine 1.6 or higher** (can be installed as part of the software installation)
- **Adobe Flash Player 11.1.102.62 or higher** (client desktop only)
- **Administrator log in privileges on the server for installation**

SUPPORTED WEB BROWSERS

- **IE 8 or higher**
- **Firefox 10.0.2 or higher**

(Although Quareo Software may work in other browsers, they have not been tested, and are not supported at this time)

Microsoft Windows Server, Red Hat Enterprise Linux, Apache Tomcat, Adobe, and Firefox are trademarks.

Quareo Physical Layer Management System

Q4000 Managed Fiber Platform

Q4000 Series Network Chassis

Q4000 Series featuring Quareo Technology allows network personnel to view, manage and audit the physical layer. This means, for the first time, the physical layer is now subject to the same compliance policy as higher layers of the network. With 70% of network outages attributed to errors made in the physical layer, TE introduces a new category of products. Simply put, Quareo enables physical layer management using connection point identification (CPID) technology.

FEATURES

- Support IEEE 802.3ae and IEEE 802.3ba (10-40-100 GB/s)
- Exceeds ANSI/TIA-568-C.3 and ISO 11801 Edition 2 cabling system requirements
- OM3/OM4 and OS1
- 19-Inch rack mountable
- Available in 2, 4, and 8 slot chassis
- 48 Fiber (24 Duplex LC) LC-to-LC or LC to MPOOptimate blade
- 192 Fiber (16 MPO Ports) MPO-to-MPO blade

ORDERING INFORMATION

Description	Part Number
1RU Network Chassis, Accommodates 2 x Q4 series blades	QCH-1RU
2RU Network Chassis, Accommodates 4 x Q4 series blades	QCH-2RU
4RU Network Chassis, Accommodates 8 x Q4 series blades	QCH-4RU



1 RU Chassis
(shown loaded)



2 RU Chassis
(shown loaded)



4RU Chassis
(shown loaded)

SPECIFICATIONS

1RU NETWORK CHASSIS

Rack Mounting:	EIA/ETSI/WECO/IEC 60297 19-inch equipment racks
Height in Rack:	1RU 44.5 mm, (1.75")
Dimensions (HxWxD):	44.5 mm x 483 mm x 338 mm (1.75" x 19" x 13.3")
Grounding:	2-screw grounding location for standard grounding lug

2RU NETWORK CHASSIS

Rack Mounting:	EIA/ETSI/WECO/IEC 60297 19-inch equipment racks
Height in Rack:	2RU 88.9 mm, (3.5")
Dimensions (HxWxD):	87.63 mm x 482.85 mm x 338 mm (3.45" x 19" x 13.3")
Grounding:	2-screw grounding location for standard grounding lug

4RU NETWORK CHASSIS

Rack Mounting:	EIA/ETSI/WECO/IEC 60297 19-inch equipment racks
Height in Rack:	4RU 177.8 mm, (7")
Dimensions (HxWxD):	177.8 mm x 483 mm x 338 mm (7" x 19" x 13.3")
Grounding:	2-screw grounding location for standard grounding lug

ENVIRONMENTAL

Operating Temperature:	-10 °C to +60° C (+14 °F to +140° F)
Storage Temperature:	-40 °C to +85° C (-40°F to +185° F)
Humidity:	5% to 95% non-condensing RoHS Compliant

SAFETY

Flammability:	(UL), c(UL), CE, A-TICK (UL) 94 V-0 UL 1863
----------------------	---

EMC

EMC Directive, 2004/108/EEC

Quareo Physical Layer Management System

Q4000 Managed Fiber Platform

Door Kits

ORDERING INFORMATION

Product Description	Part Number
Quareo 1RU Front Door Kit	QDR-1RU
Quareo 2RU Front Door Kit	QDR-2RU
Quareo 4RU Front Door Kit	QDR-4RU

Blank Chassis Covers

ORDERING INFORMATION

Product Description	Part Number
Front Blank Cover (used to cover up unpopulated chassis positions)	QBCB-HR

Chassis Controller

COMPATIBLE WITH Q4000 NETWORK CHASSIS

FEATURES

- Chassis controller (one per chassis) operates with the Q4000 series
- Designed to fit with the rear of the chassis, does not require additional rack space
- Power can be supplied through IEEE 802.3af compliant switch port (class 0) or auxiliary power supply (can be simultaneous)



ORDERING INFORMATION

Product Description	Part Number
Chassis Controller for Q4000 Network Chassis	QCPU-MCBM-1
ASSY, Power Supply without Cord	QPWRS-NO

SPECIFICATIONS

PHYSICAL:

Dimensions (HxWxD):	25.2 mm x 87.9 mm x 124.7 mm (0.99" x 3.46" x 4.91")
Electrical I/F:	RJ45
Electrical Aux. I/F:	2-Pin Micro-Fit 3.0™

ENVIRONMENTAL:

Operating Temperature:	-10° C to +60° C (+14° F to +140° F)
Storage Temperature:	-40° C to +85° C (-40° F to +185° F)
Humidity:	5% to 95% non-condensing, RoHS compliant

ELECTRICAL:

PoE Power:	IEEE 802.3af Class 0	
Auxiliary Input Power:	+48VDC @ 270mA	
Function	Unit	Notes
Input Voltage:	36 – 56 Volts	PoE 37.5 – 56V
Input Current:	.360 Amps	Max current at 36V input
Output Voltage:	5.0VDC +/- 5% Volts	
Output Current:	2.2 Amps	Max Continuous
Efficiency:	85%	Peak Efficiency @48V input
Transition Time PoE to AUX:	Seamless Sec	
Transition Time AUX to PoE:	<30 Sec	Depends on PoE power supply
PoE Classification:		Class 0

SAFETY: (UL), c(UL), CE, A-TICK, UL 1863

EMC: EMC Directive, 2004/108/EEC

NETWORK: Supports 10Base-T and 100Base-TX

Quareo Physical Layer Management System

Q4000 Managed Fiber Platform

Q4000 Series Network Blades

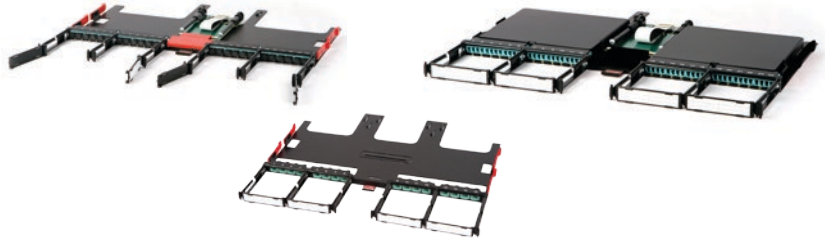

FEATURES

- Available in multimode and singlemode
- Blade controller is hot swappable in blade
- Front cable management with removable designation labels
- Rear cable management tie down points to work with Q4000 Series Network Chassis Rear Cable Management
- Blade remains powered when extended to the first position
- User Indicators blade controller (LED) Power; green alert: yellow/green
- User Indicators blade (LED) duplex ports: yellow/green for user guidance and feedback

ORDERING INFORMATION

Product Description	Polarity	Mode	Part Number
LC-to-LC Q4000 chassis blade; fiber, 24 port duplex LC, 1/2 RU blade	Adapter Only	Multimode (OM3/OM4)	QFB-48FDLCLMMHR
	Adapter Only	Singlemode	QFB-48FDLCLSMHR
LC-to-MPOptimate (12-fiber) Q4000 chassis blade; fiber, 24 port duplex LC, 1.2 RU blade	A-A/B-B (Straight)	Singlemode	QFB-48FDLCMSMHR
	A-A/B-B (Straight)	Multimode - OM3/OM4	QFB-48FDLCMMHR
Multimode: MPOptimate Performance: Factory measured maximum measured 0.35 dB loss maximum per MPO-LC OM4 module Singlemode: (<0.75 dB) @ 1310 nm/1550 nm)	A-B/B-A (Flipped)	Singlemode	QFB-48FDLCM2BSHR
	A-B/B-A (Flipped)	Multimode - OM3/OM4	QFB-48FDLCM2BPHR

Quareo Physical Layer Management System

Q4000 Managed Fiber Platform

10/40/100 Gigabit Blades

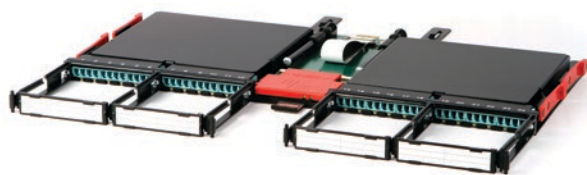

ORDERING INFORMATION

Product Description	Polarity	Mode	Part Number
Q4000 Blades			
LC to MPOptimate (24-Fiber)	A-A/B-B (Straight)	Multimode	QFB-48FDLCM4APHR
	A-A/B-B (Straight)	Singlemode	QFB-48FDLCM4ASHR
	A-B/B-A (Flipped)	Multimode	QFB-48FDLCM4BPHR
	A-B/B-A (Flipped)	Singlemode	QFB-48FDLCM4BSHR
	10G HD	Multimode	QFB-48FDLCM4FPHR
	10G HD	Singlemode	QFB-48FDLCM4FSHR
LC-to-MPOptimate (12-fiber)	10G HD	Multimode	QFB-48FDLCM2FPHR
	10G HD	Singlemode	QFB-48FDLCM2FSHR
MPOptimate (24-Fiber) to MPOptimate (8-Fiber)	A-A/B-B (Straight)	Multimode	QFB-96FMM264APHR
	A-A/B-B (Straight)	Singlemode	QFB-96FMM264ASHR
	A-B/B-A (Flipped)	Multimode	QFB-96FMM264BPHR
	A-B/B-A (Flipped)	Singlemode	QFB-96FMM264BSHR
MPO-to-MPO Q4000 Chassis Blade; fiber, 16 MPO Ports, 1/2 RU blade	MPO Adapters Only	Multimode	QFB-192FMPOMMHR
	MPO Adapters Only	Singlemode	QFB-192FMPOSMHR

BLADE SPECIFICATIONS

PHYSICAL

Dimensions (HxWxD): 19.3 mm x 438.4 mm x 373.1 mm (0.76" x 17.26" x 14.69")

ENVIRONMENTAL

Operating Temperature: -10° C to +60° C (+14° F to +140° F)

Storage Temperature: -40° C to +85° C (-40° F to +185° F)

Humidity: 5% to 95% non-condensing

ELECTRICAL

Input Power: 1.0 W Max.

COMPLIANCE

Safety: RoHS Compliant
(UL), c(UL), CE, A-TICK

Flammability: (UL) 94 V-0
UL 1863

EMC: EMC Directive, 2004/108/EEC

Quareo Physical Layer Management System

Q4000 Managed Fiber Platform

Quareo Managed Fiber Cables

MULTIMODE AND SINGLEMODE - MANAGED FIBER CABLES WITH CPID

FEATURES

- Standard colors: aqua for multimode, yellow for singlemode
- Standard materials:
 - Plenum PVC / LSZH
- Performance specifications: ANSI/TIA-568-C.3 and ISO 11801, Edition 2 for OM3/OM4 multimode, OS1 for singlemode

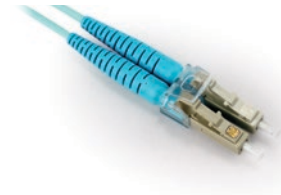

SPECIFICATIONS

Singlemode Ultra Polish Connectors (UPC)	LC
Insertion Loss:	0.3 dB max.
(1310 and 1550 nm):	0.1 dB typical
Return Loss:	-55 dB min.
(1310 and 1550 nm)	
Fiber Recess:	-100 to +50 nm
Apex Offset:	50 µm max
Radius of Curvature:	10-25 mm
Multimode (PC)	LC
Insertion Loss:	0.3 dB max
(850 and 1300 nm):	0.2 dB typical
Return Loss:	-20 dB max
(850 and 1300 nm)	

ENVIRONMENTAL:

Operating Temperature:	-10° C to +60° C (+14° F to +140° F)
Storage Temperature:	-40° C to +85° C (-40° F to +185° F)
Humidity:	5% to 95% non-condensing
RoHS Compliant	

TRANSMISSION PERFORMANCE AND RELILABILITY:

ANSI/TIA 568-C.3
ISO/IEC 11801, Edition 2

SAFETY:

UL/CSA Approved, IEC 60950, A-TICK

ORDERING INFORMATION

Description	Fiber Type		Polarity	Part Number
LC-to-LC LSZH	Multimode	OM3	A-to-A	QFPC-MPPM3ZA-xxxM
			A-to-B	QFPC-MPPM3ZB-xxxM
		OM4	A-to-A	QFPC-MPPM4ZA-xxxM
			A-to-B	QFPC-MPPM4ZB-xxxM
	Singlemode		A-to-A	QFPC-MKKSMZA-xxxM
			A-to-B	QFPC-MKKSMZB-xxxM

Replace xxx with desired length in metres or feet.

Quareo Physical Layer Management System

Q4000 Managed Fiber Platform

Quareo Managed Trunk and Fanout with Array Cables

OM3/OM4 AND SINGLEMODE LSZH

FEATURES

- Round design eliminates preferential bend issues which results in increased density and greater manageability
- Each LC leg clearly labeled and identified
- Standard breakout length 18-inches, which is optimum to connect to active equipment



ORDERING INFORMATION

Description	Fiber Type	Managed		Part Number	
		Cable Type	Connectors		
12 Fiber LSZH	Multimode	OM3	Array	12F MPO (pinned/male)-LC	QFC-1MPPM3ZPxxxMNN
			Trunk	LC-to-LC	QFC-1PPM3ZPxxxMBB
		12F MPO (no pins/female) to 12F MPO (no pins/female)		QFA-1FFM3ZPxxxMNN	
		OM4	Array	MPO (pinned/male)-LC	QFC-1MPPM4ZPxxxMNN
			Trunk	LC-to-LC	QFC-1PPM4ZPxxxMBB
		12F MPO (no pins/female) to 12F MPO (no pins/female)		QFA-1FFM4ZPxxxMNN	
	Singlemode		Array	12F MPO (pinned/male)-LC	QFC-1RKSMZPxxxMNN
			Trunk	LC-to-LC	QFC-1KKSMZPxxxMNN
	12F MPO (no pins/female) to 12F MPO (no pins/female)			QFA-1WWSMZPxxxMNN	
	24 Fiber LSZH	Multimode	OM3	Trunk	LC-to-LC
12F MPO (no pins/female) to 12F MPO (no pins/female)					QFA-2FFM3ZNxxxMBB
OM4			Trunk	LC-to-LC	QFC-2PPM4ZNxxxMBB
				12F MPO (no pins/female) to 12F MPO (no pins/female)	
Singlemode			Trunk	LC-to-LC	QFC-2KKSMZNxxxMBB
				12F MPO (no pins/female) to 12F MPO (no pins/female)	
48 Fiber LSZH	Multimode	OM3	Trunk	LC-to-LC	QFC-4PPM3ZNxxxMBB
				12F MPO (no pins/female) to 12F MPO (no pins/female)	
		OM4	Trunk	LC-to-LC	QFC-4PPM4ZNxxxMBB
				12F MPO (no pins/female) to 12F MPO (no pins/female)	
	Singlemode		Trunk	LC-to-LC	QFC-4KKSMZNxxxMBB
				12F MPO (no pins/female) to 12F MPO (no pins/female)	
96 Fiber LSZH	Multimode	OM3	Trunk	LC-to-LC	QFC-8PPM3ZNxxxMBB
				12F MPO (no pins/female) to 12F MPO (no pins/female)	
		OM4	Trunk	LC-to-LC	QFC-8PPM4ZNxxxMBB
				12F MPO (no pins/female) to 12F MPO (no pins/female)	
	Singlemode		Trunk	LC-to-LC	QFC-8KKSMZNxxxMBB
				12F MPO (no pins/female) to 12F MPO (no pins/female)	

Replace xxx with desired length in meters. Other materials available upon request.

Quareo Physical Layer Management System

Q4000 Managed Fiber Platform

Quareo Managed Trunk and Fanout with Array Cables

MPOPTIMATE OM3/OM4 LSZH

FEATURES

- Round design eliminates preferential bend issues which results in increased density and greater manageability
- Each LC leg clearly labeled and identified
- Standard breakout length 18-inches, which is optimum to connect to active equipment



ORDERING INFORMATION

Description	Fiber Type	Managed Cable Type	Connectors	Part Number	
12 Fiber LSZH	Multimode	OM3	Array	12F MPO (pinned/male)-LC	QFC-128M3ZPxxxMNN
			Trunk	LC-to-LC	QFC-188M3ZPxxxMBB
		12F MPO (no pins/female) to 12F MPO (no pins/female)		QFA-122M3ZPxxxMNN	
		OM4	Array	MPO (pinned/male)-LC	QFC-128M4ZPxxxMNN
			Trunk	LC-to-LC	QFC-188M4ZPxxxMBB
		12F MPO (no pins/female) to 12F MPO (no pins/female)		QFA-122M4ZPxxxMNN	
24 Fiber LSZH	Multimode	OM3	Trunk	LC-to-LC	QFC-288M3ZNxxxMBB
				12F MPO (no pins/female) to 12F MPO (no pins/female)	
		OM4	Trunk	LC-to-LC	QFC-288M4ZNxxxMBB
				12F MPO (no pins/female) to 12F MPO (no pins/female)	
48 Fiber LSZH	Multimode	OM3	Trunk	LC-to-LC	QFC-488M3ZNxxxMBB
				12F MPO (no pins/female) to 12F MPO (no pins/female)	
		OM4	Trunk	LC-to-LC	QFC-488M4ZNxxxMBB
				12F MPO (no pins/female) to 12F MPO (no pins/female)	
96 Fiber LSZH	Multimode	OM3	Trunk	LC-to-LC	QFC-888M3ZNxxxMBB
				12F MPO (no pins/female) to 12F MPO (no pins/female)	
		OM4	Trunk	LC-to-LC	QFC-888M4ZNxxxMBB
				12F MPO (no pins/female) to 12F MPO (no pins/female)	

Replace xxx with desired length in meters. Other materials available upon request.

Quareo Physical Layer Management System

Q4000 Managed Fiber Platform

24-Fiber MPO Trunks for 10/40/100

BENEFITS

- Connectivity and breakouts are optimized for use with 10, 40 and 100 Gigabit fiber management systems
- Small profile – 24-fiber trunks are only 3.8 mm (0.150”) In diameter
- Less clutter at the panel – Each MPO connects 24 pre-terminated fibers at once
- Uniform polarity, pins and path – TE’s 10/40/100 fiber roadmap assures that the components are interoperable and will work without having to configure a fiber map with every MAC
- OM4 fiber – the highest standard for multimode Ethernet transmission
- Assured performance – Each assembly is pre-tested in the factory, and test data is traceable via a bar code to a test database
- Re-usable – can be upgraded by simply changing the components (blades, cassettes, adaptors) at the end
- Color coding – Unique strain relief indicators clearly indicate the fiber count and type
- Field cleaning – using TE products especially designed to work with LC and MPO connectivity, you can always “clean before you connect”, greatly reducing end-face contamination and risk of negative impact on system performance
- Warranted – when deployed by an approved TE Connectivity installer, MPO trunks are covered under our 25 year system warranty (please see our warranty statement for details)



SPECIFICATIONS:

MPOptimate Performance:

Advanced components and assembly techniques, coupled with stringent acceptance criteria, provide low loss and greater system flexibility

Standard Fiber Path:

Compatible with TIA 568-C.0-2 draft standard for polarity Method “A” (for 40 and 100 Gigabit Ethernet)

24-Fiber System Compatible:

Fiber path supports 10, high density 10, 40 and 100 Gigabit deployment

Non-Pinned Trunks:

Pins are resident in the panels, greatly reducing the risk of pin damage during MACs

ORDERING INFORMATION

Description	Connectors	Jacket Type	Part Number
Quareo Trunk Cables			
24-Fiber MPO to 24-Fiber MPO			
Multimode OM4, MPOptimate 24-Fiber Cable 24” Breakouts on each end	24-Fiber MPO (no pins) to 24-Fiber MPO (no pins)	LSZH	QFA-244M4ZNxxxMBB
Singlemode, 24-Fiber Cable 24” Breakouts on each end	24-Fiber MPO (no pins) to 24-Fiber MPO (no pins)	LSZH	QFA-266SMZNxxxMBB
(1) 24-Fiber MPO to (3) 8-Fiber MPO			
Multimode OM4, MPOptimate 24” Breakouts on each end	24-Fiber MPO (no pins) to (3) 8-Fiber MPO (no pins)	LSZH	QFA-242M4ZYxxxMBB
Singlemode 24” Breakouts on each end	4-Fiber MPO (no pins) to (3) 8-Fiber MPO (no pins)	LSZH	QFA-26WSMZyxxxMBB

Note: Additional configurations and lengths are available. Contact TE for assistance.

Quareo Physical Layer Management System

Q4000 Managed Fiber Platform

SPECIFICATIONS FOR ARRAY CABLE: MEASURED THROUGH MPO MATED PAIR TO LC ADAPTER

Multimode (OM3, OM4)

Insertion Loss (dB)	850 nm	1300 nm
Maximum:	0.70 dB	0.70 dB
Typical:	0.25 dB	0.4 dB
Return Loss (dB)		
Maximum:	-20 dB	-20 dB

Singlemode

Insertion Loss (dB)	1310 nm	1550 nm
Maximum:	1.0 dB	1.0 dB
Typical:	0.25 dB	0.35 dB
Return Loss (dB)		
Minimum:	-55 dB	-55 dB

SPECIFICATIONS FOR TRUNK CABLE : MPO-TO-MPO AND LC-TO-LC

Multimode (OM3, OM4)

Insertion Loss (dB)	850 nm	1310 nm
Maximum:	0.70 dB	0.70 dB
Typical:	0.25 dB	0.4 dB
Return Loss (dB)		
Maximum:	-20 dB	-20 dB

Singlemode

Insertion Loss (dB)	1310 nm	1550 nm
Maximum:	1.0 dB	1.0 dB
Typical:	0.25 dB	0.35 dB
Return Loss (dB)		
Minimum:	-55 dB	-55 dB

Quareo Physical Layer Management System

QHDEP High Density Equipment Panels

Overview

HIGH DENSITY EQUIPMENT PANEL FEATURING QUAREO TECHNOLOGY (QHDEP)

The QHDEP is a 1RU (1.75") fiber optic connector panel with six technician-friendly access trays. Each tray features a mounting location for holding one LC or MPO adapter pack, or MPO module or cabled module. A single access tray can serve up to 24 LC fiber connections or 8 MPO fiber connections. At full capacity, the QHDEP panel will hold up to 144 (LC) or 48 (MPO) fiber connections. Each panel includes mounting brackets for 19-inch (48.26cm), 23-inch, or ETSI mounting applications.



CONNECTION POINT IDENTIFICATION (CPID)

TE's CPID technology provides a unique identifier for every Quareo-enabled component in the network – enabling immediate recognition of a patch cord upon installing or removing. CPID gives network operators complete visibility to all connection events in the network and provides detailed information on the network elements being used.

ADAPTER PACKS

Adapter packs are designed to provide easy connector insertion/removal, and clearer adapter port identification. Adapter packs are available in 24-fiber (12 duplex) LC or eight MPO adapter pack configurations. Each tray supports one adapter pack, for a total of up to six packs per chassis.



24 port LC adapter pack



8 port MPO adapter pack

MPO MODULES

MPO modules offer the same craft-friendly interface management as adapter packs, but include a low-loss MPO adapter at the rear for connecting an MPO trunk cable. MPO modules are available in 12-fiber LC-MPO, or 24-fiber LC-MPO configurations. Support for MPOptimate performance.



LC to MPO module

CABLED MODULES

Cabled modules have the same factory tested termination as MPO modules or adapter packs except they have a fiber cable pigtail exiting the rear. These pigtails can be directly terminated or spliced at the other end to eliminate excess cable length. Cabled modules are available in LC (24-fiber) configurations.



24 fiber LC cabled module

Quareo Physical Layer Management System

QHDEP High Density Equipment Panels

High Density Equipment Panel featuring Quareo Technology (QHDEP)

The 1RU QHDEP is part of the end-to-end Quareo physical layer management system utilizing CPID technology. It is designed to hold LC or MPO adapter packs, LC-MPO modules, or LC cabled modules.



- Supports Quareo 1RU Panel Controller
- Quareo user LED indicators
 - Chassis status
 - Tray level / work order (one LED per each access tray)
 - Port level / work order
- Panel doors, mounting ears and vertical cable guides are included with the panel
- Mounting dimensions HxWxD: 1.75 x 19/23 x 20 inches (4.5 x 48.3/58.4 x 50.8 cm)
- Cable clamps and breakout cable management solutions are available for incoming trunk cables
- Maintenance Services available



PANEL CAPACITY

Connector Type	Fibers
LC	144-fiber (72 duplex ports)
MPO	48 ports (576 fibers using 12-fiber MPO or 1152 fibers using 24-fiber MPO)

ORDERING INFORMATION

Description	Part Number
1RU QHDEP Empty Panel	QE-HEP-1000000000
1RU QHDEP Panel with Controller	QE-HEP-10000S0000

SPECIFICATIONS

MECHANICAL

Dimensions DxWxH: 19.64" x 19.09" x 1.7"
(49.9 cm x 48.5 cm x 4.32 cm)

Weight: 14.9 lb (8.1 kg)

ELECTRICAL

Power consumption: 12.95W max
Voltage: 37-57 VDC, 48VDC nominal
Input current: 350mA @ 37VDC

ENVIRONMENTAL

Operating conditions: +14° F to +140° F (-10° C to +60° C)
5% to 95% RH

Storage conditions: -40° F to +158° F (-40° C to +70° C)
10% to 95% RH

COMPONENTS

See following pages for supported adapter packs and modules.

Quareo Physical Layer Management System

QHDEP High Density Equipment Panels

Controller

The controller unit mounts into a slot on the front side of a single high density equipment panel to provide power and functionality for communicating over the network with the Quareo software / middleware.

FEATURES

- Supports a 1RU high density fiber panel
- User Indicators:
 - Power - Green
 - Status - Red/Green
 - Ethernet Jack - Green - Link/Activity
 - Ethernet Jack - Yellow - 100 Base-TX
- Maintenance Services available on this product

SPECIFICATIONS

PHYSICAL

Dimensions (HxWxD): 25.2 mm x 76.2 mm x 113mm
(0.99"x 3"x 4.45")
Electrical I/F: RJ45
Electrical Aux. I/F: 4-Pin pluggable terminal

ENVIRONMENTAL

Operating Temperature: +14° F to +140° F
(-10° C to +60° C)
Storage Temperature: -40° C to +70° C
(-40° F to +158° F)
Humidity: 5% to 95% non-condensing
RoHS Compliant

ELECTRICAL

Power Input (or Aux Supply)
Power Over Ethernet (PoE) Input:
- IEEE 802.3af - class 0 PD - 12.95W max

AUX INPUT

- Dual input, diode or'd
- Input Voltage: 37-57 VDC, 48 VDC nominal
- Input Current: 350mA at 37VDC
- Mating Connector: TE 284506-4 or equivalent

AC POWER SUPPLY

- Input Voltage: 100-240VAC
- Input Current: 0.5A max
- Output Voltage: 48V
- Output Current Max: 0.40A
- Max Watts: 19.2W

AUX CONNECTOR

- 4 Position Terminal Block (TE Part 284506-4)
- Pitch: 3.5mm
- Wire Gauge Range: 30-14
- Current Rating: 11A
- Voltage Rating: 300VAC

COMMUNICATIONS

- 10/100Base-T/TX



ORDERING INFORMATION

Description	Part Number
Controller for 1RU QHDEP panel	QE-HEP-CTR1000000

*Controller can be ordered separately or included with the network chassis

Quareo Physical Layer Management System

QHDEP High Density Equipment Panels

Adapter Packs

Universal adapter packs are designed to accept a variety of connector types, including singlemode and multimode, angled and ultra-polished connections. The flexibility of the universal adapter pack helps service providers reduce ordering SKU's and total inventory requirements. The staggered adapter pack design helps installers access connectors without pinching or moving adjacent connections; it also eliminates the need for installers to use an extraction tool, and helps clearly identify individual fiber ports. One 24-fiber (12 duplex port) LC adapter pack can be installed per tray or one eight-port MPO adapter pack (12- or 24-fiber MPO) per tray; up to six total adapter packs per panel. A specially designed latch window on the rear of the adapter pack allows easy identification of the connector type on the front side of the unit. As a result, technicians will always know the connector type installed on the unit, no matter if they are working from the front or rear side of the panel.

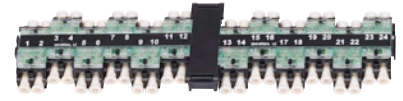

LC adapter pack



MPO adapter pack

ORDERING INFORMATION

Description	Part Number
Managed Adapter Pack, LC-LC Black, 24 fibers (24 simplex ports, managed front and rear)	QE-ADP-24HPLCS000
Managed Adapter Pack, LC-LC Black, 24 fibers (12 duplex ports, managed front and rear)	QE-ADP-24HPLCD000
Managed Adapter Pack, LC-LC Black, 24 fibers (12 duplex ports, managed front only)	QE-ADP-24HPLCE000
Managed Adapter Pack, LC-LC Black, 24 fibers (24 simplex ports, managed front only)	QE-ADP-24HPLCF000
Managed Adapter Pack, MPO-MPO Black, 96 fibers (8, 12F MPO, managed front and rear)	QE-ADP-96HPMPG000
Managed Adapter Pack, MPO-MPO Black, 96 fibers (8, 12F MPO, managed front only)	QE-ADP-96HPMPF000
Managed Adapter Pack, LC-LC Aqua, 24 fibers (12 duplex ports, managed front and rear)	QE-ADP-24HP0CD000
Managed Adapter Pack, LC-LC Blue, 24 fibers (12 duplex ports, managed front and rear)	QE-ADP-24HP0KD000
Managed Adapter Pack, LC-LC Green, 24 fibers (12 duplex ports, managed front and rear)	QE-ADP-24HP0MD000
Managed Adapter Pack, MPO-MPO Aqua, 192 fibers (8, 24F MPO ports, managed front and rear)	QE-ADP-192HPMAG000
Managed Adapter Pack, MPO-MPO Green, 192 fibers (8, 24F MPO ports, managed front and rear)	QE-ADP-192HPMGG000

Quareo Physical Layer Management System

QHDEP High Density Equipment Panels

MPO Modules

The MPO module offers a craft-friendly interface for connecting 24 LC connectors to an MPO adapter – enabling a rapid connection to electronics or a fiber tie panel such as TE’s Rapid Fiber panel solution. Leveraging an MPO architecture, technicians can route and install higher fiber counts faster and easier, while simplifying cable inventory and ordering requirements. Up to 6 MPO modules can be loaded per panel and are available as a dual 12-fiber LC-MPO for singlemode and multimode configurations or a single 24-fiber LC-MPO multimode configurations. Support for MPOptimate performance.



LC-MPO module - right orientation

SPECIFICATIONS

MPOptimate Performance:

- o Multimode 12f MPO – LC: Factory measured 0.35 dB loss maximum per MPO-LC OM4 module
- o Multimode 24f MPO – LC: Factory measured 0.35 dB loss maximum per MPO-LC OM4 module

Singlemode Performance:

(<0.75 dB) @ 1310 nm/1550 nm)

Insertion & Return Loss:

IL <= 0.35dB

RL >= 27dB

Traceable:

Each module is uniquely identified and linked to factory measurement data

Standard Fiber Path:

Compatible with TIA 568-C.0-2 draft standard for Method A

24-Fiber Trunk Compatible:

Fiber path supports 24-fiber deployment

Pinned Cassettes:

MPO alignment pins are maintained inside the module, reducing damage risk

Used in Pairs:

Assures proper fiber map, polarity and location of MPO alignment pins

Quareo Physical Layer Management System

QHDEP High Density Equipment Panels

ORDERING INFORMATION

	Module Orientation	Adapter Color	LC Port Monitoring	Polarity	Part Number	
LC-to-MPOptimate (2x12-fiber MPO) QHDEP Module Multimode MPOptimate (OM4); Loss (<0.35 dB @ 850 nm/1300 nm)	Left	Black	Simplex	A-A/B-B (Straight)	QE-MPM-24HPCUMLA	
	Right				QE-MPM-24HPCUMRA	
	Left		Duplex		QE-MPM-24HPDUMLA	
	Right				QE-MPM-24HPDUMRA	
	Left	Aqua	Duplex	A-A/B-B (Straight)	QE-MPM-24HPFAHLA	
	Right				QE-MPM-24HPFAHRA	
	Left				A-B/B-A (Straight)	QE-MPM-24HPFAHLB
	Right					QE-MPM-24HPFAHRB
LC-to-MPOptimate (1x24-fiber MPO) QHDEP Module Multimode MPOptimate (OM4); Loss (<0.35 dB @ 850 nm/1300 nm)	Left	Aqua		Duplex	A-A/B-B (Straight)	QE-MPM-24HPFAJLA
	Right					QE-MPM-24HPFAJRA
	Left				A-B/B-A (Flipped)	QE-MPM-24HPFAJLB
	Right					QE-MPM-24HPFAJRB
	Left		10G HD	QE-MPM-24HPFAJLG		
	Right			QE-MPM-24HPFAJRG		
MPO (1x24-Fiber) to MPO (3x8-Fiber) QHDEP Multimode MPOptimate (OM4); Loss (<0.35 dB @ 850 nm/1300 nm)	Straight	Black	MPO	A-A/B-B (Straight)	QE-MPM-48GAGUA	
LC-to-MPO(2x12-fiber MPO) QHDEP Module Singlemode; Loss (<0.75 dB @ 1310 nm/1550 nm)	Left	Black	Simplex UPC	A-A/B-B (Straight)	QE-MPM-24HPKUELA	
	Right				QE-MPM-24HPKUERA	
	Left		Simplex APC		QE-MPM-24HPMUELA	
	Right				QE-MPM-24HPMUERA	
	Left	Blue	Duplex UPC	A-A/B-B (Straight)	QE-MPM-24HPNBELA	
	Right				QE-MPM-24HPNBERA	

Order "L" option for mounting MPO module on left side of chassis (LC connectors facing forward)



Order "R" option for mounting MPO module on right side of chassis (LC connectors facing forward)

Quareo Physical Layer Management System

QHDEP High Density Equipment Panels

Multifiber Cable Assemblies

TE's Quareo-enabled multifiber cable assemblies are LSZH, GR 409 compliant, and designed for use in a variety of in-building environments. Built with reduced bend radius technology, each cable assembly provides ideal cable protection and reduces concerns around proper handling, slack storage and attenuation loss from tight bends. The robust microcable design offers maximum space savings, and is available in Singlemode and multimode configurations.

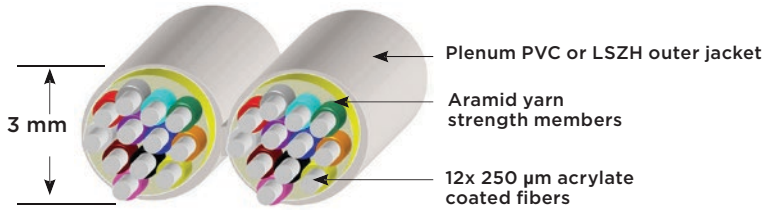

24-fiber dual-zip microcable



MPO Trunk Cable



Cabled Modules

Cabled modules will save operators significant time and cost in their cable deployments. Using the LC cabled module, for example, an installer can route a 24-fiber cable to any access tray in the panel, then rapidly terminate the module's 24-fiber connectors with a single click, rather than installing 24 individual connectors. Cabled modules are available in 24-fiber (12 duplex) LC in Singlemode or multimode configurations. Each module is designed for craft friendliness. Individual adapter ports are labeled for easy identification. Cabled modules are ordered as part of a multifiber cable assembly.



LC cabled module with 24-fiber microcable installed in panel



24-fiber LC cabled module

Quareo Physical Layer Management System

QHDEP High Density Equipment Panels

Cable Specifications for 3 mm 24-Fiber Zip LSZH Rated Microcable

JACKET COLOR

Singlemode Plenum Rated: Yellow
Multimode OM4: Aqua

ENVIRONMENTAL

Storage Temperature: -40° to 70° C (-40° to 158° F)
Operating Temperature: 0° to 70° C (32° to 158° F)
Installation Temperature: 0° to 50° C (32° to 122° F)

MECHANICAL

Number of Fibers: 24
Maximum Tensile Load
Short Term: 660 N (150 lbf)
Long Term: 200 N (45 lbf)
Minimum Bend Radius
Installed: 30mm (1.18")
Loaded: 60mm (2.36")
Maximum Compression: 10 N/mm (57 lbf/in)
Maximum Impact: 2.94 N•m (2.17 lbf•ft)

COMPLIANCES

- Telcordia GR-409-CORE Interconnect Category, Impact and compression compliant to horizontal and vertical backbone cable requirements
 - Tensile compliant to horizontal backbone cable requirements
 - UL 910 plenum flammability rating
 - EIA/TIA FOTPS
EIA/TIA 568-B
NFPA 262, NEC OFNP, FT-6
 - Restriction of the use of hazardous substances. RoHS (2002/95/EC)
 - California Prop 65 for Safe Drinking Water and Toxic Enforcement Act
- ¹Reduced Bend Radius Fiber is compliant to ITU-T G.652.D, ITU-T G.657A&B, and IEC 60793-2-50 Type B.1.3

ORDERING INFORMATION

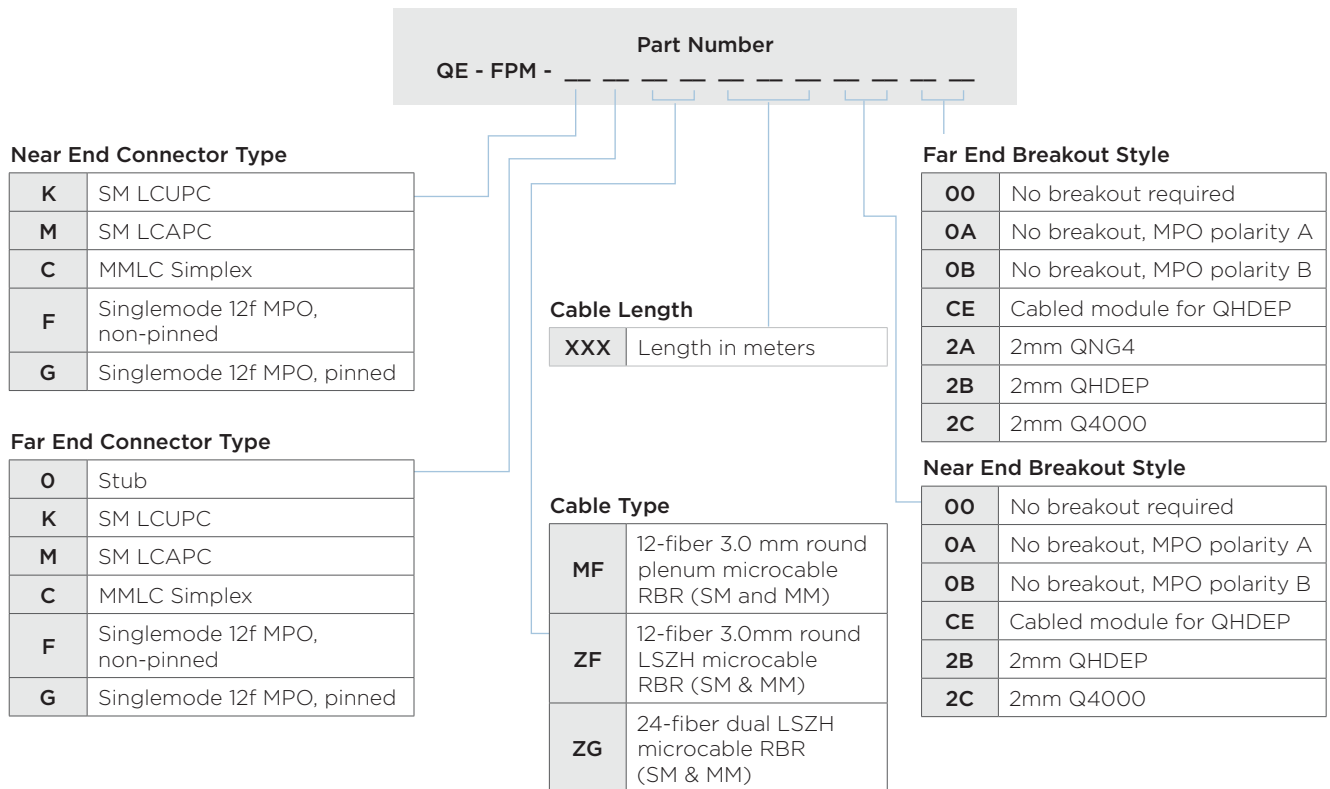

Note: For multimode MPO cable assembly options, see TE document no. 109883AE.

Quareo Physical Layer Management System

QHDEP High Density Equipment Panels

Fiber Patch Cords

As an integral part of the Quareo physical layer management product portfolio, TE's multimode and singlemode fiber patch cords are essential to meet the requirements of today's high-speed data networks. These managed fiber patch cords can be used throughout the network in cross-connect, test, or equipment areas to link optical equipment.



ORDERING INFORMATION SIMPLEX

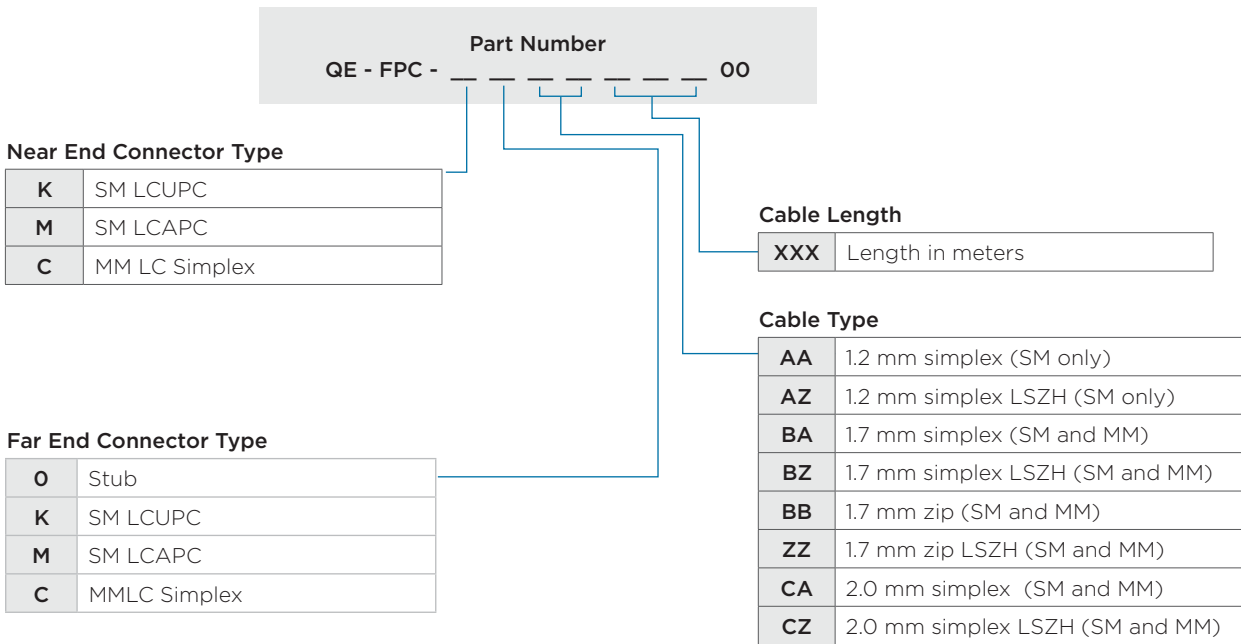

ORDERING INFORMATION DUPLEX

Description	Fiber Type		Polarity	Part Number
LC-to-LC LSZH	Multimode	OM3	A-to-A	QFPC-MPPM3ZA-xxxM
			A-to-B	QFPC-MPPM3ZB-xxxM
		OM4	A-to-A	QFPC-MPPM4ZA-xxxM
			A-to-B	QFPC-MPPM4ZB-xxxM
	Singlemode		A-to-A	QFPC-MKKSMZA-xxxM
			A-to-B	QFPC-MKKSMZB-xxxM

Replace xxx with desired length in meters or feet



Quareo Physical Layer Management System

QHDEP High Density Equipment Panels

Intrafacility Cable

TE's Quareo-enabled intrafacility cable is designed to meet fire resistant characteristics for in-building applications. Fiber counts range from 72 to 144. Standard IFC assemblies are riser rated and meet UL-1666 OFNR. Two types of IFC cable are available: stranded and ribbon.



Preterminated IFC Cable with LC Connectors

ORDERING INFORMATION

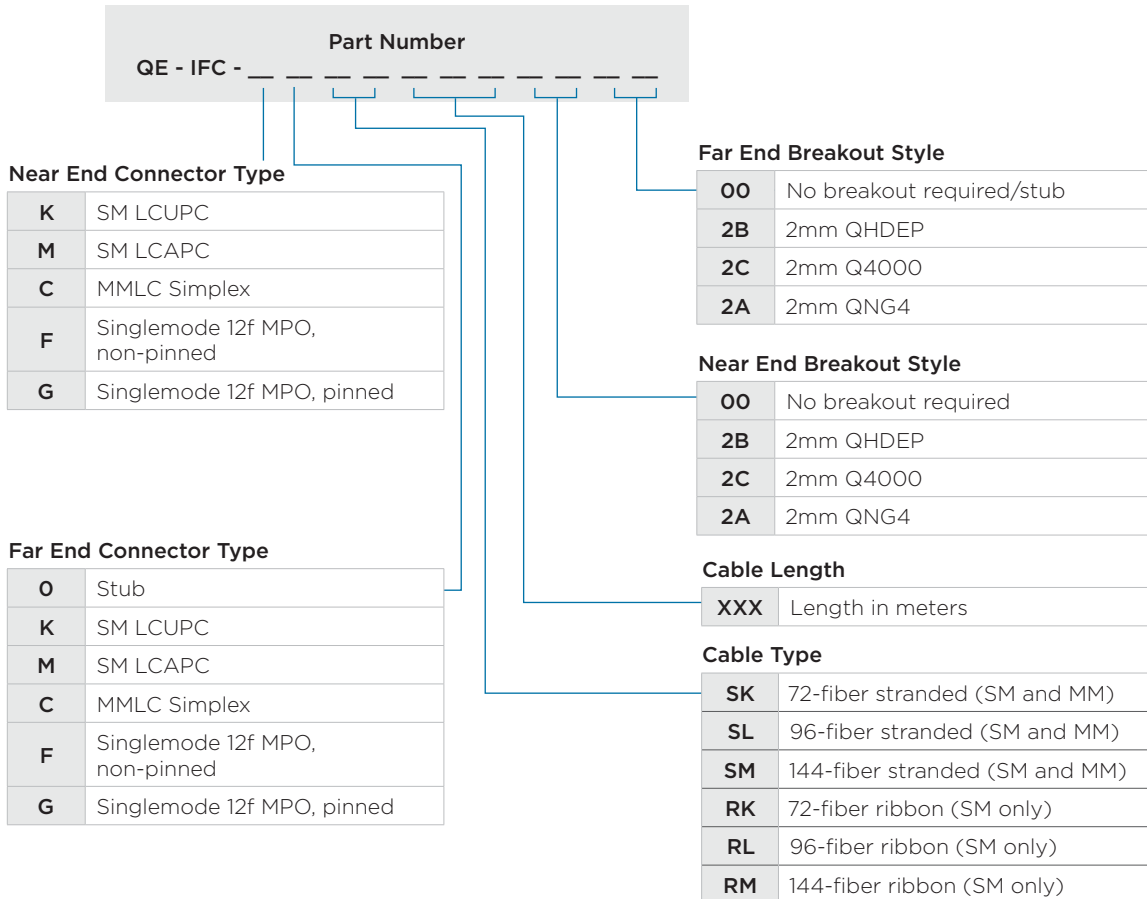

*LSZH cables available upon request

CONNECTOR SPECIFICATIONS

QUAREO FIBER CABLES

SINGLEMODE ULTRA POLISH CONNECTORS (UPC) LC

Insertion Loss:	0.3 dB max
(1310 and 1550nm):	0.1 dB typical
Return Loss:	-55 dB min
(1310 and 1550nm)	
Fiber Recess:	-100 TO +50 nm
Apex Offset:	50 μm max
Radius of Curvature:	10-25 MM

MULTIMODE (PC) LC

Insertion Loss:	0.3 dB max
(850 and 1300nm):	0.2 dB typical
Return Loss:	-20 dB max
(850 and 1300nm)	

SINGLEMODE LOW LOSS MPO CONNECTOR

Insertion Loss:	0.45 dB max
(1310 1490, 1550 and 1625nm)	
Return Loss:	-55 dB min
(1310 1490, 1550 AND 1625NM)	

ENVIRONMENTAL:

Operating Temperature:	-10° C to +60° C (+14° F to +140° F)
Storage Temperature:	-40° C to +85° C (-40° F to +185° F)
Humidity:	5% to 95% non-condensing
RoHS Compliant	

TRANSMISSION PERFORMANCE AND RELIABILITY:

ANSI /TIA 568-C.3, ISO /IEC 11801, Edition 2

Safety:

U L/CSA Approved, IEC 60950, A-TICK

Quareo Physical Layer Management System

QHDEP High Density Equipment Panels

ACCESSORIES FOR THE QHDEP

Cable Clamp Kits

To be used for cable to chassis fixation. Not included with the panel.

ORDERING INFORMATION

Description	Part Number
Cable Clamp Kit - Large For cable diameters 0.81" through 1.10". Includes one bracket with a mounting location and hardware for one cable	QE-HEP-ACCUCCL0000
Cable Clamp Kit - Small Universal cable clamp kit for cable diameters .40" through .80". Includes one bracket with mounting locations and hardware for two cables	QE-HEP-ACCUCCS0000

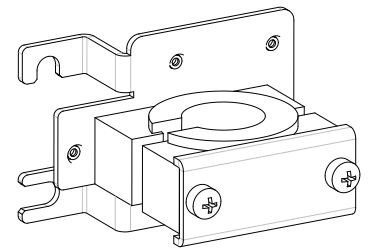

Large Cable Clamp

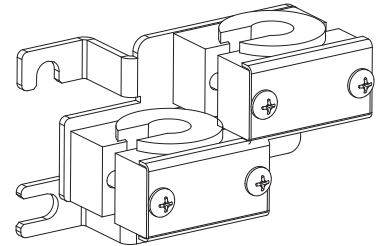

Small Cable Clamp

IFC Breakout Cable Management

To be used for multi-fiber breakout cable installations. Not included with the panel.

ORDERING INFORMATION

Description	Part Number
Fanout Installation kit, 900 μm fibers Secures 900 μm fanout and manages un-reinforced 900 μm fibers installed in the chassis	
Left	QE-HEP-ACCUFKR0000
Right	QE-HEP-ACCUFKL0000

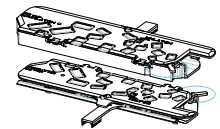

Left and Right Tray Fanout Kit

Cable Cross-Over Manager

To be used for addressing cable exit to one side only, typically cabinet applications.

ORDERING INFORMATION

Description	Part Number
Snap-on bracket to manage cables crossing over or underneath a 1RU chassis	QE-HEP-ACCIDRK0000

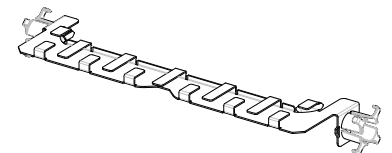

Cable Cross-Over Manager

Power Cable Kit

ORDERING INFORMATION

Description	Part Number
Power Supply with US Cable (Power Supply Optional when not using PoE)	QE-HEP-ACCUPWR0000
Power Supply without Cable	QE-HEP-ACCUPWR0001

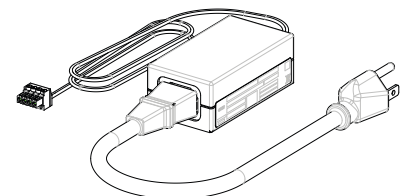

Power Cable Kit

Quareo Physical Layer Management System

Q2000 Copper Network Panels

Q2000 Series Network Panels

Q2000 series network panels featuring Quareo technology allow network personnel to view, manage and audit the physical layer. This means, for the first time, the physical layer is now subject to the same compliance policy as higher layers of the network. With 70% of network outages attributed to errors made in the physical layer, TE introduces a new category of products. Simply put, Quareo enables managed connectivity using connection point identification (CPID) technology.

FEATURES

- Quareo enabled functionality with dual color port illumination (LED)
- Integral cable management bar
- 45° IDC contacts providing secure, gas-tight connections
- Accepts 110 style termination tools
- Universal 568A/B wiring
- Discrete labeling system

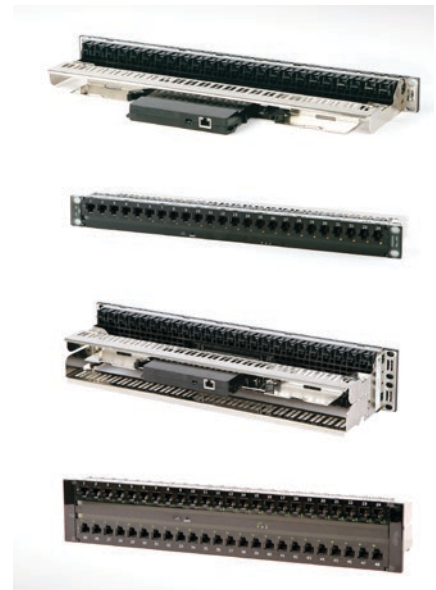

PANEL SPECIFICATIONS

1RU 24-PORT PHYSICAL

Rack Mounting: 44.5 mm x 1.75 mm (19" x 1RU)

2RU 48-PORT PHYSICAL

Rack Mounting: 88.9 mm, x 3.50 mm (19" x 2RU)

ENVIRONMENTAL

Operating Temperature: -40° to 70° C (104 to 158° F)

Number of Plug Insertions: ≥ 750 (IEC/EN 60603-7)

CABLE DIAMETER RANGE

Solid and Stranded Copper Conductors: 26 AWG to 22 AWG (0.4 mm dia to 0.6 mm dia) solid core cable and 24 AWG stranded cable.

Wire Insulation Diameter Range: 1.04 mm to 1.60 mm (0.041" x 0.063")

Insulation Resistance: at 40° C and 93% RH ≥ 500 M Ω

Contact Resistance: ≤ 1 m Ω typical

Jack Contact Re-terminations: ≥ 200

COMPLIANCE :

UL/CSA Approved, CE, A-TICK

UL 94 V-0

UL186

RoHS compliant

Performance to ANSI/TIA-568-C.2 and ISO 11801, Edition 2 for

Category 6/Class E and Category 6a/Class EA.

Independently certified

RJ socket, 8 positions FCC Part (IEC 60603-7)

ORDERING INFORMATION

Product Description	Part Number
24 port (1RU) network panel with jacks	
CAT 6A U/UTP	QCPP-24MC6AU
CAT 6A STP	QCPP-24MC6AS
CAT 6 U/UTP	QCPP-24MC6U
48 port (2RU) network panel with jacks	
CAT 6A U/UTP	QCPP-48MC6AU
CAT 6A STP	QCPP-48MC6AS
CAT 6 U/UTP	QCPP-48MC6U

Quareo Physical Layer Management System

Q2000 Copper Network Panels

Panel Controller for Q2000 Network Panels

FEATURES

- Panel controller operates with the Q2000 family of network panels
- Designed to fit inside the rear cable manager without interfering with panel connectivity, does not require additional rack space
- Power can be supplied through IEEE 802.3af PoE class 0 compliant switch port or additional auxiliary power supply (can be simultaneous)
- Link and activity status LEDs at the rear of unit
- Seamless power transition from PoE to aux supply



CONTROLLER SPECIFICATIONS

Product Dimensions (HxWxD): 21 mm x 143 mm x 105 mm (0.82" x 5.62" x 4.142")

Environmental

Operating Temperature: -10° C to +60° C (+14° F to +140° F)

Compliance

Flammability: (UL) 94 V-0
RoHS Compliant
UL/CSA Approved, CE, C-TICK
Conformance with 8 way modular (RJ45) jack requirements according to IEC-60603-7 series and TIA/EIA-968-A (FCC 68.500)

Alternate Input Power: Alternate power source to comply with AC/DC desktop power supply brick

MINIMUM REQUIREMENTS:

Input Voltage: 100-240VAC, 50-60Hz, 0.5A

Output Voltage: 48VDC, 0.4A

ELECTRICAL

Input Voltage:

Input Current:

Efficiency:

Transition Time PoE to AUX:

Transition Time AUX to PoE:

PoE Classification:

Network

FUNCTION

36 - 56 Volts

.200 Amps

85%

Seamless Sec

<30 Sec

Class 0

Supports 10BASE-T
and 100BASE-TX

NOTES

PoE 37.5 - 56V

Max current at 36V input

Peak Efficiency @48V input

Depends on PoE Power Supply

15.4 Watt max power consumption if using PoE (power consumption based on the switch providing power).

ORDERING INFORMATION

Product Description

Part Number

Panel controller for Q2000 Network Panels

QCPU-MPPM-1

Quareo Physical Layer Management System

Q2000 Copper Network Panels

Copper Cables for Q2000 Network Panels



FEATURES

- Quareo technology with connection point identification
- Connector interface: plug type RJ45 shielded/unshielded that conforms to 8 way modular RJ45 jack in accordance with IEC 60603-7 series and TIA/EIA-968-A
- Latch type: snagless
- Boot: flexible with built in strain relief to maintain proper bend radius
- Wiring configuration: T568A, T568B and T568A - T568B (cross-over)

SPECIFICATIONS

Electrical:	ANSI/TIA-568-C.2 and ISO 11801, Edition 2 for Category 6/Class E and Category 6A/Class Ea Category 5e, 5 and 3 backward compatible
Environmental:	Controlled Environment GR-63, Section 4.1.2
Operating Temperature:	-10° C to +60° C
Storage Temperature:	-0° C to +50° C
Relative Humidity:	5% to 90% non-condensing
Relative Humidity:	5% to 95% non-condensing
Compliance:	UL 94 V-0 TICK N355 C(UL)us 49S3 CE RoHS and IEEE 2002/95/EC Directive on the restriction of the use of certain hazardous substances in electrical and electronic equipment

ORDERING INFORMATION

Product Description	Available Colors Replace XX	Available Lengths Replace YY		LSZH		Part Number
Category 6 U/UTP managed copper cable	BK = Black BL = Blue GN = Green OR = Orange RD = Red GY = Gray VT = Violet WT = White YL = Yellow	04'	15'	LSZH	T568A	QCPC-6RUZA-XXYYM
		07'	25'		T568B	QCPC-6RUZB-XXYYM
		10'	50'		Crossover	QCPC-6RUZX-XXYYM
Category 6A U/UTP managed copper cable	GY = Gray VT = Violet WT = White YL = Yellow	01 m	02 m	LSZH	T568A	QCPC-6ARUZA-XXYYM
		03 m	05 m		T568B	QCPC-6ARUZB-XXYYM
		7.5 m			Crossover	QCPC-6ARUZX-XXYYM
Category 6A S/FTP managed copper cable	BL = Blue GY = Gray WT = White	01 m	02 m	LSZH	T568A	QCPC-6ARSZA-XXYYM
		03 m	05 m		T568B	QCPC-6ARSZB-XXYYM
		7.5 m			Crossover	QCPC-6ARSZC-XXYYM

Quareo Physical Layer Management System

Q2000 Copper Network Panels

Accessories for the Q2000 Network Panels

ORDERING INFORMATION

Product Description	Part Number
Power Supply	
ASSY, Power Supply with US Cord (power supply optional when using PoE)	QPWRS-USA
No ASSY, Power Supply without Cord	QPWRS-NO
Quareo Jacks	
CAT 6 U/UTP Quareo Jack 12 per package	1-1671660-3
CAT 6A U/UTP Quareo Jack 12 per package	1-1671660-2
CAT 6A STP Quareo Jack 12 per package	1-1671660-1
Quareo Jack Punch down Pads	6645 1 180-01

Quareo Physical Layer Management System

AMPTRAC Technology

AMPTRAC introduction

The TE AMPTRAC product series is a physical layer management solution based on the 9th wire technology. The AMPTRAC products can be used with the Quareo software and provide the ability to know, in real time, when & where physical connectivity changes take place in the network

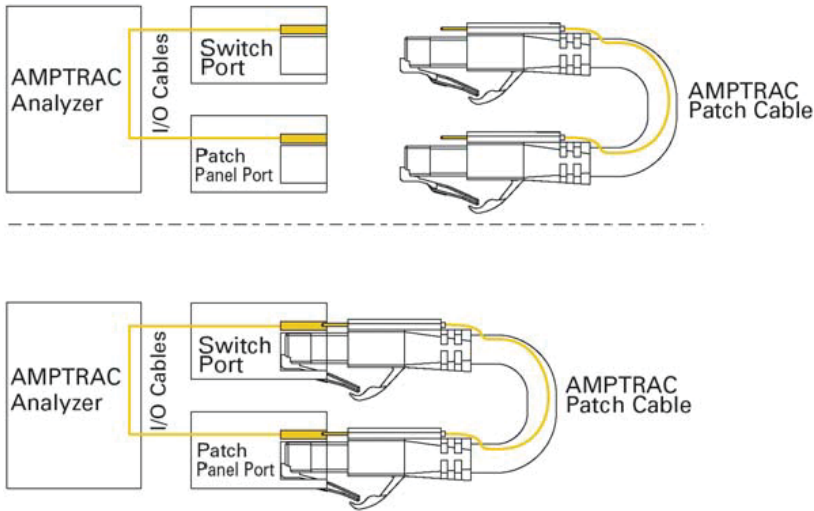

BASIC OPERATING PRINCIPLE

- Robust 9th wire in patch cords establishes open and closed circuits which can be monitored
- Analyzer monitors open/closed circuit and tracks connectivity
- Analyzer sends data to Quareo Software data base

The AMPTRAC Infrastructure Management System discovers connects/disconnects and communicates the port ID information in real-time to the Quareo Software database over a TCP-IP connection via the AMPTRAC Analyzer. When a patch cord is inserted or removed from a port, the AMPTRAC sensory circuit immediately notifies the database software to update and document the change in connectivity. Any change in connectivity can be checked and authorization verified, and if appropriate, action taken if the action is unauthorized.

To gain all this information every port on patch panels and switches is equipped with a sensor pad. All sensor pads are connected to the analyzer

PRODUCT FACTS

- Fully automated documentation system
- Real time monitoring
- Automatic database update on changes
- Self-discovers patch cords

Quareo Physical Layer Management System

AMPTRAC Analyzer

AMPTRAC Analyzers

FEATURES

- Adds the physical layer to your network documentation system
- Universal analyzer design
 - Analyzer can be configured as a master or slave unit
 - Any unit can directly communicate to database server or through another analyzer
 - Virtually unlimited in number of ports/drops which can be monitored
- Very flexible design and implementation allowing for use in office buildings, data centers and remote/branch offices
- Analyzers sold with Quareo Software license
- Available in 384 port, 768 port or 1152 port versions (19", 1U)
- Shallow depth at 6.25" (160 mm)
- Suitable for shelve or 19" rack or cabinet mounting
- Large 4 line LCD display providing interactive communications with the database
- Use of latest and current circuitry design
- Minimum heat dissipation - no concerns over heat management in rack or cabinet
- Low power consumption and long lifetime
- Dual external PSUs supported



Remote Scanning module required

ORDERING INFORMATION

Description	Part Number
AMPTRAC ANALYZER HD 1152 (Quareo Software Included)	1-1591360-1
AMPTRAC ANALYZER HD 768 (Quareo Software Included)	2-1591360-3
AMPTRAC ANALYZER HD 384 (Quareo Software Included)	3-1591360-1
Additional External PSU	1-1591364-0
Scanning Module	1-1591363-0

Quareo Physical Layer Management System

AMPTRAC Scanning Module Cables

AMPTRAC Scanning Module Cable Assemblies

Every patch panel or switch port has a copper sensor pad associated with it. All sensor pads are connected to the AMPTRAC analyzer via a scanning module and scanning module cable. The scanning module has two types of connector, an RJ45 connector, which is used to connect the module to the analyzer via a standard Category 5 or Category 6 patch cable and a 2.0mm AMPMODU connector, which connects the module to the switch or patch panel via the scanning module cable. For monitored devices of less than 24 ports, multiple cables can be inserted into the AMPMODU connector equal to the 24 port total. Each scanning module cable is between 2-4 feet long allowing the scanning module to be located on the left or the right and be secured on the cable support management bar or onto the rack/cabinet.

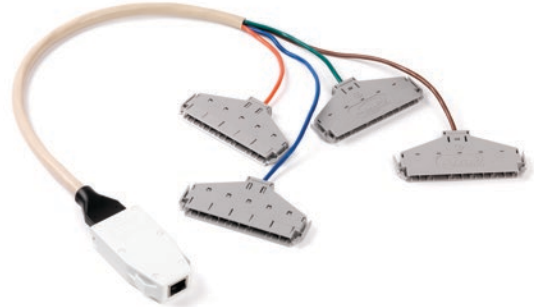

ORDERING INFORMATION

Description	# Positions	Length (ft)	Part Number
AMPTRAC patch panels utilizing the 6-position SL Interface Module, i.e. SL panels, HD Panels, Quick-Fit Panels; 110 Plug-n-Play to 2.0mm MODU Latching	24	2	2111440-2
24-port Sensor Strips for electronics, EMEA AMPTRAC Ready and EMEA 7AS Panels (rear attachment); 2.0 mm MODU to 2.0mm MODU Latching	24	2	2111441-2
	24	4	2111441-4
AMPTRAC MRJ-21 patch panels, EMEA AMPTRAC Ready patch panels (front attachment), ACO; HD-22 to 2.0mm MODU Latching	24	2	2111442-2
AMPTRAC Fiber Optic MPO Cassettes; RJ-11 to 2.0mm MODU Non-Latching	6	1.5	2111443-1
AMPTRAC MRJ21 XG quick fit Cassette	8	2	2153175-2
	2	4	2111444-4
AMPTRAC Sensor Strips for LAN electronics based on # positions; 2.0 mm MODU to 2.0mm MODU Non-Latching	6	4	2111445-4
	8	4	2111446-4
	12	4	2111447-4
	16	4	2111448-4

Quareo Physical Layer Management System

AMPTRAC Fiber Platform

AMPTRAC Optical Fiber Patch Panels

FEATURES

- Available for LC Duplex and SC Duplex systems
- Available in OM3, OM4 and singlemode
- Support field termination or use with MPO cassettes
- Duplex LC SL Series inserts sold separately.

ORDERING INFORMATION

Description	Part Number
Snap-In SC Adaptor Plate, 6 ports (12 fibers); Fiber Type: Multimode (beige)	1435657-1
Snap-In SC Adaptor Plate, 6 ports (12 fibers); Fiber Type: Singlemode (blue)	1435657-2
Snap-In SC Adaptor Plate, 6 ports (12 fibers); Fiber Type: Singlemode APC (green)	1435657-3
MPO/SC Snap-In Cassette, 6 ports (12 fibers); Pairs: straight; Fiber Type: OM3 XG 10 Gb/s	1435688-1
MPO/SC Snap-In Cassette, 6 ports (12 fibers); Pairs: flipped; Fiber Type: OM3 XG 10 Gb/s	1435688-2
MPO/SC Snap-In Cassette, 6 ports (12 fibers); Pairs: straight; Fiber Type: Singlemode	1435689-1
MPO/SC Snap-In Cassette, 6 ports (12 fibers); Pairs: flipped; Fiber Type: Singlemode	1435689-2
MPO/LC Quick-Fit Cassette, 6 ports (12 fibers); Pairs: straight; Fiber Type: OM3 XG 10 Gb/s	1671209-3
MPO/LC Quick-Fit Cassette, 6 ports (12 fibers); Pairs: flipped; Fiber Type: OM3 XG 10 Gb/s	1-1671209-3
MPO/LC Quick-Fit Cassette, 6 ports (12 fibers); Pairs: straight; Fiber Type: Singlemode	1671209-4
MPO/LC Quick-Fit Cassette, 6 ports (12 fibers); Pairs: flipped; Fiber Type: Singlemode	1-1671209-4
MPOOptimate/LC Quick-Fit Cassette, 6 ports (12 fibers); Pairs: straight; Fiber Type: OM4	1671229-5
MPOOptimate/LC Quick-Fit Cassette, 6 ports (12 fibers); Pairs: flipped; Fiber Type: OM4	1-1671229-5
LC AMPTRAC Quick-Fit Module, 6 ports (12 fibers); Fiber Type: OM3 XG 10 Gb/s	1933420-2
LC AMPTRAC Quick-Fit Module, 6 ports (12 fibers); Fiber Type: SM	1933420-3
1U drawer loaded with 24 LC Duplex AMPTRAC Inserts (48 fibers); Fiber Type: Singlemode	1671149-1
1U drawer for loaded with 24 LC Duplex AMPTRAC Inserts (48 fibers); Fiber Type: OM3 XG 10 Gb/s	1671149-3
1U Drawer for 4 MPO AMPTRAC Quick-Fit Cassettes or Quick-Fit modules	1671149-5

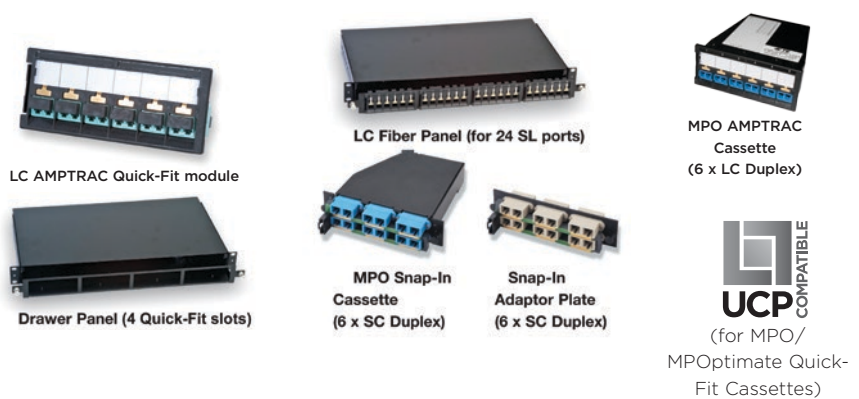

Quareo Physical Layer Management System

AMPTRAC Fiber Patch Cords

AMPTRAC Fiber Optic Patch Cords

FEATURES

- Exceeds optical performance specifications for OM3, OM4 and single mode
- Patch Cord assemblies contain copper conductor connected to external pin
- External pin makes contact with sensor pad on Patch Panel or switch
- Cable is a mini-tri-zip design for flexibility and small size
- Available for LC Duplex and SC Duplex assemblies
- MPOptimate Optical performance:
Attenuation :IL \leq 0.15dB, Return Loss: RL \geq 35dB
- SM Optical performance:
Attenuation: IL \leq 0.5 dB, return Loss: RL \geq 20dB



LC DUPLEX



SC DUPLEX

ORDERING INFORMATION

Description	Part Number	Y- -X	Length
LC Duplex to LC Duplex; MPOptimate OM4	Y-2160052-X	0- -1	1 m
LC Duplex to LC Duplex; OM3 XG 10 Gb/s	Y-2055438-X	0- -2	2 m
LC Duplex to LC Duplex; Singlemode	Y-1435791-X	0- -3	3 m
LC Duplex to SC Duplex; OM3 XG 10 Gb/s	Y-1435796-X	0- -5	5 m
LC Duplex to SC Duplex; Singlemode	Y-1435797-X	0- -7	7 m
SC Duplex to SC Duplex; OM3 XG 10 Gb/s	Y-1435725-X	1- -0	10 m
SC Duplex to SC Duplex; Singlemode	Y-1435726-X		

Quareo Physical Layer Management System

AMPTRAC Copper Platform

MRJ21 XG Quick-Fit AMPTRAC Cassette 8 Port (10 Gb/s)

FEATURES

- Adds AMPTRAC functionality to MRJ21 XG cabling
- Compatible to MRJ21 XG cable assemblies for 10GbE performance

Color: black (RAL 9005)

ORDERING INFORMATION



Description	Part Number
MRJ21 XG Quick-Fit AMPTRAC cassette for 10GBase-T	2153091-1

MRJ21 XG 19" AMPTRAC Patch Panel, 1U, straight

FEATURES

- Adds AMPTRAC functionality to MRJ21 XG cabling
- Factory terminated and tested solution
- Compatible with MRJ21 XG cable assemblies for 10GbE performance
- Straight panel with either 24 or 48 ports on 1U

Color: black (RAL 9005)

ORDERING INFORMATION



Description	Part Number
Straight AMPTRAC panel 1U for 10GbE; MRJ21 Plugs: 6; RJ-45 Ports: 24	2153040-1
Straight AMPTRAC panel 1U for 10GbE; MRJ21 Plugs: 12; RJ-45 Ports: 48	2153049-1

MRJ21 AMPTRAC Patch Panels

FEATURES

- High-density, small form factor connectivity
- Factory terminated and tested
- Modular, pluggable design
- 4 pair MRJ21 Patch Panels for 10Base, 100Base-T and 1000Base-T
- 2 pair MRJ21 Patch Panels for 10Base and 100Base-T

ORDERING INFORMATION

Description	Part Number
Shielded 24 port straight Patch Panel; 4 pair (10/100/1000Base-T)	1711944-2
Unshielded 24 port straight Patch Panel; 4 pair (10/100/1000Base-T)	1777029-2
Unshielded 48 port straight Patch Panel; 4 pair (10/100/1000Base-T)	1777041-1
Unshielded 48 port straight Patch Panel; 2 pair (10/100Base-T)	1777042-1
Unshielded 48 port angled Patch Panel; 4 pair (10/100/1000Base-T)	1777053-1



Quareo Physical Layer Management System

AMPTRAC Copper Platform

Category 6 - AMPTRAC PCB Patch Panel (STP)

FEATURES

- 19", 1U, RJ-45 Patch Panel with 24 ports
- Category 6 Pyramid tested
- LSA-Plus® tool compatible enhanced 110 IDC blocks
- 10 Gigabit Ethernet ready
- Rear cable management
- Cover adapts to different cable diameters via variable snap-in position
- Shield connection separated from strain relief
- Including grounding bolt
- Universal wiring - T568 A or B wiring pattern
- Protected PCB

Color: black (RAL 9005)



ORDERING INFORMATION

Description	Part Number
Shielded Cat. 6 Full AMPTRAC 24 port Patch Panel, Color: black	1644042-1

Category 6 - AMPTRAC PCB Patch Panel (UTP)

FEATURES

- 19", 1U, RJ-45 Patch Panel with 24 ports
- Category 6 Pyramid tested
- LSA-Plus® tool compatible enhanced 110 IDC blocks
- 10 Gigabit Ethernet ready
- Rear cable management
- Including grounding bolt
- Universal wiring - T568 A or B wiring pattern
- Protected PCB

Color: black (RAL 9005)



ORDERING INFORMATION

Description	Part Number
Unshielded Cat. 6 Full AMPTRAC 24 port Patch Panel, Color: black	1711147-1

Quareo Physical Layer Management System

AMPTRAC Copper Platform

STP/UTP SL 110C Jack Patch Panels (w/o Rear Cable Management)

FEATURES

- Available in standard straight version or in angled version for improved cable and space management
- Uses AMP NETCONNECT high-performance SL Series 110C Modular Jacks
- I/O connection made with 110C PlugnPlay Cable Assembly
- Cost-effective AMPTRAC *Ready!* solution: install AMPTRAC Patch Panels now and analyzer and software later
- Category 6 Patch Panels come with Modular Jacks bagged separately (unloaded) for field termination with SL Series Modular Jack Termination Tool.



ORDERING INFORMATION

Description	Part Number
Unshielded Cat. 6, 24 port panel; Type: Straight; Height: 1U	1933327-1
Unshielded Cat. 6, 48 port panel; Type: Straight; Height: 2U	1933328-1
Unshielded Cat. 6, 24 port panel; Type: Angled; Height: 1U	1933329-1
Unshielded Cat. 6, 48 port panel; Type: Angled; Height: 2U	1933330-1
Shielded XG 24 Port Panel; Type: Straight; Height: 1U	1933331-1
Shielded XG 48 Port Panel; Type: Straight; Height: 2U	1933332-1
Shielded XG 24 Port Panel; Type: Angled; Height: 1U	1933333-1
Shielded XG 48 Port Panel; Type: Angled; Height: 2U	1933334-1

Category 3 - AMPTRAC *Ready!* 50 Port Telephone Patch Panel

FEATURES

- 19", 1U, Telephone Panel with 50 ports
- AMPTRAC *Ready!* high-end version
- Active Pin-out: 36,45
- Conductor diameter range from AWG 26-22 (0.4-0.65 mm)
- Easy upgrade to AMPTRAC Infrastructure Management
- Rear cable management for multipair cables
- 110Connect blocks for conductor insulation diameters up to 1.28 mm

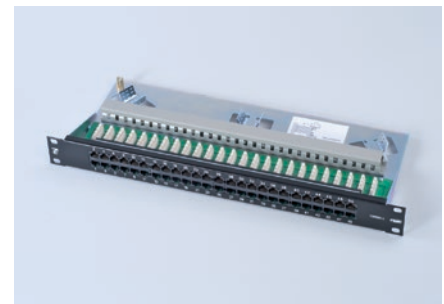

ORDERING INFORMATION

Description	Part Number
AMPTRAC <i>Ready!</i> 50 port panel; Color: light gray (RAL 7035)	1394060-1
AMPTRAC <i>Ready!</i> 50 port panel; Color: black (RAL 9005)	1394060-2
I/O upgrade kit to full AMPTRAC	1435954-1

Quareo Physical Layer Management System

AMPTRAC Copper Platform

STP & UTP Quick-Fit Modules

FEATURES

- Used to add AMPTRAC functionality to AMP-TWIST SL Jack cabling
- STP version has automatic bonding by design
- Labels included
- Set of 4 modules

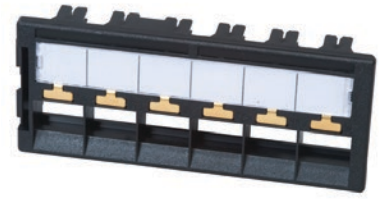

ORDERING INFORMATION

Description	Part Number
STP AMPTRAC ready Quick-Fit module (4 pcs)	1933196-1
UTP AMPTRAC ready Quick-Fit module (4 pcs)	1933197-1

Angled AMPTRAC Modular Quick-Fit Panel (unloaded)

FEATURES

- 19" 1U angled modular Patch Panel to be equipped with different SlimLine jacks without dust cover
- Adjustable & removable rear cable bracket incl. easy to use cable organizing CaRe-clips
- Including grounding bolt



Color: black (RAL 9005)

ORDERING INFORMATION

Description	Part Number
Angled Full AMPTRAC Modular panel for UTP SL Jacks	1-1671136-3
Angled Full AMPTRAC Modular panel for STP SL Jacks	1-1671136-4

Flushmount AMPTRAC Modular Quick-Fit Panel (unloaded)

FEATURES

- 19" 1U unloaded flushmount panel to be equipped with different SlimLine jacks
- Suitable for UTP and STP jacks
- Including grounding bolt



Color: black (RAL 9005)

ORDERING INFORMATION

Description	Part Number
Flushmount Full AMPTRAC Modular Panel	1-1671187-1

Quareo Physical Layer Management System

AMPTRAC Copper Platform

Flushmount AMPTRAC Standard Patch Panel (unloaded)

FEATURES

- 19" unloaded flushmount Patch Panel to be equipped with different SlimLine jacks
- Full AMPTRAC
- Accepts up to 24 SL Jacks without dust cover
- Including grounding bolt



ORDERING INFORMATION

Description	Part Number
Full AMPTRAC unloaded Panel for AMP-TWIST 6 jacks; Color: black (RAL 9005)	1711685-4
Full AMPTRAC unloaded Panel for AMP-TWIST 7 jacks; Color: black (RAL 9005)	1711742-1

AMPTRAC Scanning Module Upgrade Kit for 1U Patch Panels

FEATURES

- Brings AMPTRAC functionality to AMPTRAC *Ready!* Patch Panels
- Front and rear Scanning Module cable connection



ORDERING INFORMATION

Description	Part Number
AMPTRAC Upgrade Kit with front Scanning Module port, Color: black	1711148-1
AMPTRAC Upgrade Kit with rear Scanning Module port, Color: black	1711148-4
AMPTRAC Cat. 7 Δ S Upgrade Kit with rear Scanning Module port; Color: black	1711749-1



Quareo Physical Layer Management System

AMPTRAC Copper Patch Cords

Twisted Pair Patch Cords Assemblies

FEATURES

- Patch Cord assemblies contain 9th conductor that is connected to external probe molded into the modular plug boot
- External probe makes contact with sensor pad on Patch Panel or switch
- Off-center probe designed to accommodate stacked-jack LAN switch configurations
- LSZH jacket
- Over-molded snagless boots

Color: white



ORDERING INFORMATION

Description	Performance	Part Number
4pr AMPTRAC: AMP-TWIST 7 _A S to AMP-TWIST 7 _A S; LSZH S/FTP	Cat. 7 _A / Class F _A	Y-1711755-X
4pr AMPTRAC: AMP-TWIST 7 _A S to RJ-45; LSZH S/FTP	Cat. 6 _A / Class E _A	Y-1711756-X
4pr AMPTRAC: RJ-45 to RJ-45; LSZH S/FTP	Cat. 6/ Class E _A	Y-1711548-X
2pr AMPTRAC: AMP-TWIST 7 _A S to RJ-45, Ethernet pinout 1236; LSZH S/FTP	Cat. 5E/ Class D	Y-1711757-X
2pr AMPTRAC: AMP-TWIST 7 _A S to RJ-45, ISDN pinout 3645; LSZH S/FTP	Cat. 5E/ Class D	Y-1711760-X
4pr AMPTRAC: RJ-45 to RJ-45; LSZH UTP, 1 m	Cat. 6/ Class E _A	1711351-5
4pr AMPTRAC: RJ-45 to RJ-45; LSZH UTP, 2 m	Cat. 6/ Class E _A	1711351-6
4pr AMPTRAC: RJ-45 to RJ-45; LSZH UTP, 3 m	Cat. 6/ Class E _A	1711351-7
4pr AMPTRAC: RJ-45 to RJ-45; LSZH UTP, 5 m	Cat. 6/ Class E _A	1711351-8

Y- X	Length
0- -1	1 m
0- -2	2 m
0- -3	3 m
0- -5	5 m

Quareo Physical Layer Management System

AMPTRAC Sensor Strips

Sensor Strips for LAN Electronics

FEATURES

- Sensor strips are readily available for a number of LAN electronic equipment types
- Easy mounting and installation
- The below Product Parts shows a selection of commonly used switch models
- Custom sensor strips can be designed on request to work with other LAN electronic equipment (LAN equipment manufacturer, model number, and model revision are required in determining the selection of the proper sensor strip)

Important note: Port footprint of LAN electronic model may be changed by manufacturer without notification! To prevent sensor pad mismatch, always double-check your actual LAN electronics model with scaled sensor strip template (PDF). For switch models not listed or additional information ask your local AMP NETCONNECT sales contact.



ORDERING INFORMATION

Description	Part Number
Ports per Strip: 24; Typical Switch: CISCO 4000 and 6000, 48-Port Blades	1435346-1
Ports per Strip: 24; Typical Switch: CISCO 3500 and 4548, 48-Port	1435346-4
Ports per Strip: 26; Typical Switch: CISCO 2950, 24-Port + 2 Uplink Ports	1435827-1
Ports per Strip: 24; Typical Switch: NORTEL BAYSTACK 470-48T, 48-Port	1435939-1
Ports per Strip: 8; Typical Switch: HP Procurve J4111A	1933098-1
Ports per Strip: 24; Typical Switch: HP Procurve J8702A & 3500yl	1933899-1
Ports per Strip: 24; Typical Switch: CISCO 2960	1933241-1

More sensor strips available, contact local sales team for details.

Quareo Physical Layer Management System

Accessories

Cable Management Brackets and Bars

FEATURES

- Brackets and bars provide support for Scanning Module cables or Patch Cords
- Front mount to monitored Patch Panels and switches
- Adjustable universal brackets for use at left or right panel edge



ORDERING INFORMATION

Description	Part Number
Universal Scanning Module cable bracket 40 mm, single-side-mount	1499659-1
Universal Scanning Module cable bracket 100 mm, single-side-mount	1499659-2
Universal Scanning Module cable bracket 448 mm, double-side-mount	1499659-3
1U Cable Management Bar Rack Mounting	1557548-1
1U Cable Management Bar Patch Panel Mounting	1933425-1

9. Optical LAN Solutions

Overview.....	140
---------------	-----

Optical LAN Solution

Overview

As optical fiber moves closer to end users, rapid changes are underway in both the data center and the equipment closet. As a result, new installation and maintenance techniques are being employed within enterprise applications. Passive Optical Network (PON) applications are now being deployed. Fiber is no longer limited to just access equipment. Fiber connectivity to a single user is a reality.

TE Connectivity offers complete, end-to-end PON infrastructure solutions called Optical LAN Solution (OLS). From the data center to the desktop, our customers have tapped the experience and innovation of TE to build their PON networks. TE's suite of end-to-end connectivity solutions is truly comprehensive. This ordering guide highlights the most commonly used components that feature field-proven attributes that can save time, money and help improve customer satisfaction.

The diagram below highlights an example of PON deployment using a TE OLS solution. Each number corresponds to a specific innovative TE product which is described in more details in the OLS System Solution Guide, available on TE website.

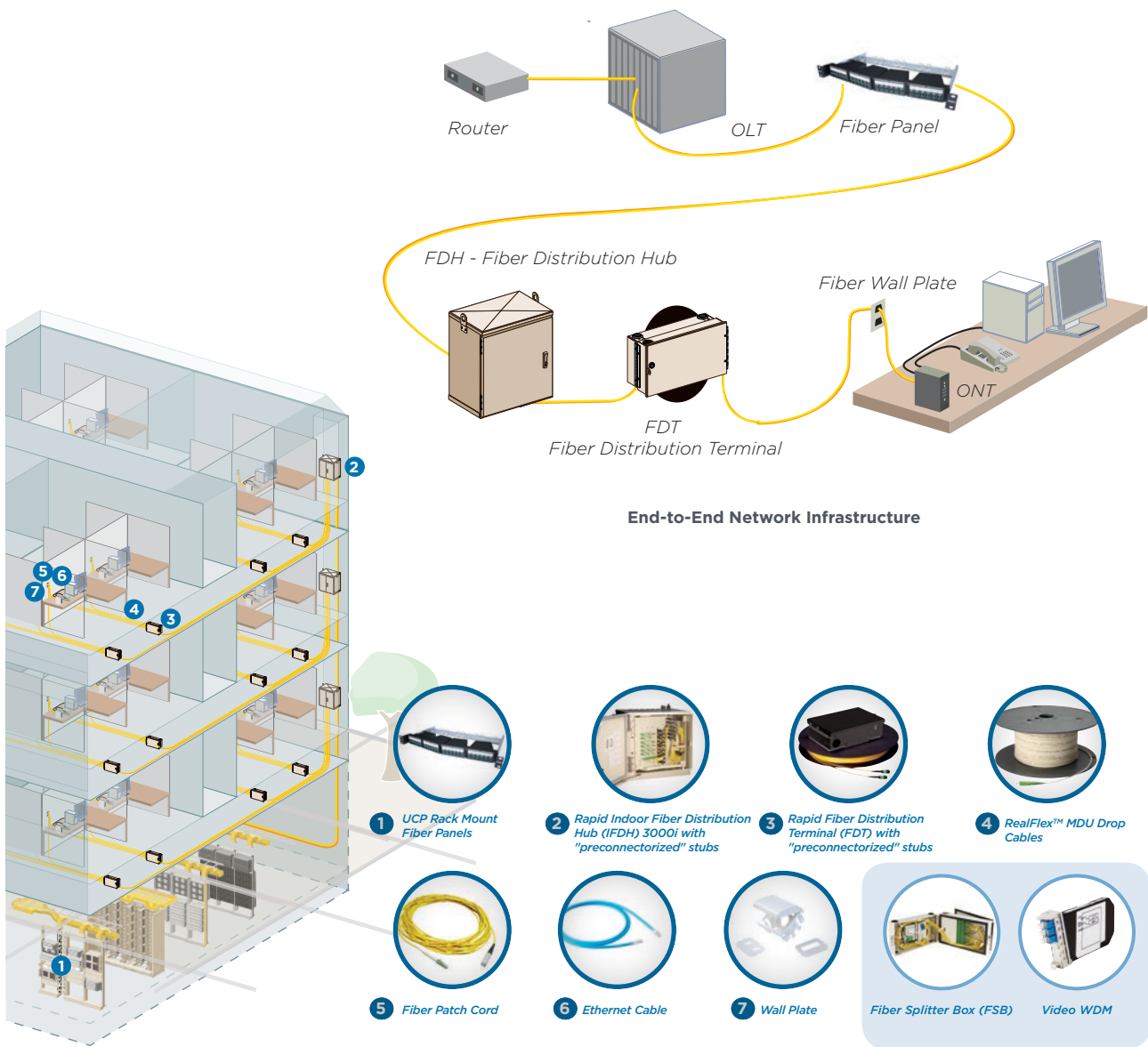

10. AMP CO System

AMP CO Ultra Panels	142
AMP CO Ultra Outlets	145
AMP CO Inserts.....	149
AMP CO Tools & Accessories.....	156

AMP CO Ultra Quick-Fit 8 Port Patch Panel

FEATURES

- 19" 1U patch panel for 8 AMP CO Ultra Inserts
- Fast termination and easy assembly
- Shielded housing with patented automatic shielding clamp
- Straight cable exit plus management bar
- Kit includes 4 AMP CO Ultra Quick-Fit Kits, mounting material and grounding bolt
- Performance up to 2.0 GHz



ORDERING INFORMATION

Description	Color	Part Number
AMP CO Ultra Quick-Fit 8 Port Patch Panel	Light grey (RAL 7035)	2153112-1
	Black (RAL 9005)	2153112-3

AMP CO Ultra Quick-Fit 16 Port Patch Panel

FEATURES

- 19" 2U patch panel for 16 AMP CO Ultra Inserts
- Fast termination and easy assembly
- Shielded housing with patented automatic shielding clamp
- Straight cable exit plus management bar
- Kit includes 8 AMP CO Ultra Quick-Fit Kits, mounting material and grounding bolt
- Performance up to 2.0 GHz



ORDERING INFORMATION

Description	Color	Part Number
AMP CO Ultra Quick-Fit 16 Port Patch Panel	Light Grey (RAL 7035)	2153113-1
	Black (RAL 9005)	2153113-3

AMP CO Ultra 24 Port High Density Patch Panel

FEATURES

- 19" 2U patch panel for 24 AMP CO Ultra Inserts
- Fast termination and easy assembly
- Shielded housing with patented automatic shielding clamp
- Straight cable exit plus management bar
- Kit includes 24 die cast housings, 24 AMP CO Plus Edge Connectors, frames, mounting material and grounding bolt
- Performance up to 2.0 GHz

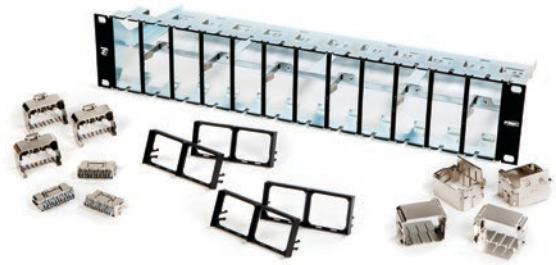

ORDERING INFORMATION

Description	Color	Part Number
AMP CO Ultra 24 Port High Density Patch Panel	Light Grey (RAL 7035)	1711686-1
	Black (RAL 9005)	1711686-3

UCP Patch Panel Angled and Flushmount

Please refer to Chapter 4, page 50

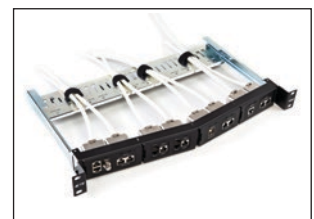

AMP CO System

AMP CO Ultra Panels

AMP CO Ultra Quick-Fit Kit

FEATURES

- Fits in UCP Patch Panel angled and flush mount as well as consolidation point boxes
- Fast termination and easy assembly
- Shielded housing with patented automatic shielding clamp
- Kit includes 2 die-cast housings, 2 shielded edge connectors and frame for labelling
- Performance up to 2.0 GHz



ORDERING INFORMATION

Description	Color	Part Number
AMP CO Ultra Quick-Fit Kit	Black (RAL 9005)	2153014-1

CP Box for Quick-Fit Cassettes & Modules

FEATURES

- Consolidation point box ready for 1 AMP CO Ultra Quick-Fit Kits
- Robust sheet metal construction
- Two separate zones; installation zone and user zone
- Hinged cover with knurled screw
- Dust protection for the full connection
- Grounding bolt included



ORDERING INFORMATION

Description	Color	Part Number
CP Box for Quick-Fit Cassettes & Modules	Black (RAL 9005)	1-1671414-1

AMP CO Ultra Distribution Box

FEATURES

- 1U distribution box for surface mount or raised floor use for 8 AMP CO Ultra Inserts
- Robust sheet metal construction
- Fast termination and easy assembly
- Shielded housing with patented automatic shielding clamp
- Kit includes 4 AMP CO Ultra Quick-Fit Kits, mounting material and grounding bolt
- Performance up to 2.0 GHz



ORDERING INFORMATION

Description	Color	Part Number
AMP CO Ultra Distribution Box	Black (RAL 9005)	2153173-3

AMP CO Ultra Installation Kit DIN 50x50

FEATURES

- Fast termination and easy assembly
- Shielded installation kit flush mount
- DIN faceplate 50 x 50 mm
- Compatible with standard and designer frame series
- Metal frame ready for different footprint or fixation configurations
- Shielded edge connector for AWG 22-24 twisted pair cables
- Shielded housing with tangible screen termination
- Strain relief by cable tie
- Top, left or right cable entry
- 2.0 GHz performance

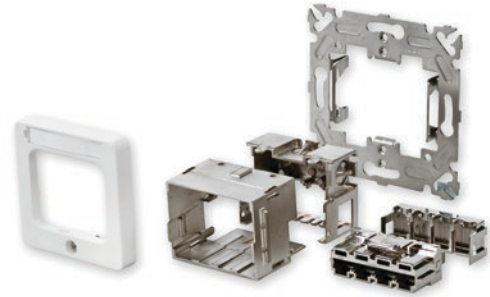

ORDERING INFORMATION

Description	Color	Part Number
AMP CO Ultra Installation Kit DIN 50x50	Almond (RAL 1013)	1711655-1
	Black (RAL 9005)	1711655-3
	Pure White (RAL 9010)	2-1711655-1

AMP CO Ultra Installation Kits DIN 68x68

FEATURES

- Fast termination and easy assembly
- Shielded installation kit flush mount
- Straight or angled versions
- DIN faceplate 68 x 68 mm
- Metal frame ready for different footprint or fixation configurations
- Shielded edge connector for AWG 2-24 twisted pair cables
- Shielded housing with tangible screen termination
- Strain relief by cable tie
- Top, left or right cable entry
- 2.0 GHz performance

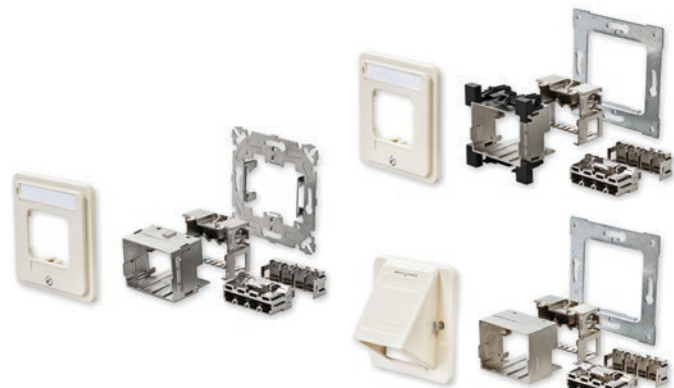

ORDERING INFORMATION

Description	Color	Part Number
AMP CO Ultra Installation Kit DIN 68x68	Almond (RAL 1013)	1711856-1
AMP CO Ultra Installation Kit DIN 68x68	Pure White (RAL 9010)	2-1711856-1
AMP CO Ultra Installation Kit DIN 68x68 Top	Almond (RAL 1013)	1711870-1
AMP CO Ultra Installation Kit DIN 68x68 Top	Pure White (RAL 9010)	2-1711870-1
AMP CO Ultra Installation Kit DIN 68x68 Angled	Almond (RAL 1013)	1711875-1
AMP CO Ultra Installation Kit DIN 68x68 Angled	Pure White (RAL 9010)	2-1711875-1

AMP CO Ultra Installation Kit DIN Floor Box

FEATURES

- Fast termination and easy assembly
- Shielded installation kit floor box
- Shielded edge connector for AWG 22-24 twisted pair cables
- Shielded housing with tangible screen termination
- Strain relief by cable tie
- Bottom cable entry
- 2.0 GHz performance

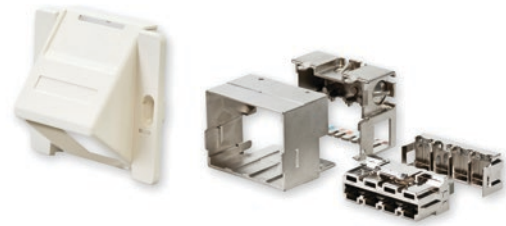

ORDERING INFORMATION

Description	Color	Part Number
AMP CO Ultra Installation Kit DIN 50x50 Floor Box	Almond (RAL 1013)	1711876-1
AMP CO Ultra Installation Kit DIN 70x58 Floor Box	Almond (RAL 1013)	1711855-1

AMP CO Ultra Installation Kit Swiss “EDIZIOdue Compatible”

FEATURES

- Fast termination and easy assembly
- Shielded installation kit flush mount and surface mount
- Faceplate applicable to “EDIZIOdues Compatible” systems
- Shielded edge connector for AWG 22-24 twisted pair cables
- Shielded housing with tangible screen termination
- Strain relief by cable tie
- Top, left or right cable entry
- 2.0 GHz performance



ORDERING INFORMATION

Description	Color	Part Number
AMP CO Ultra Installation Kit Swiss EDIZIOdue Compatible AP	Pure White (RAL 9010)	1711869-1
AMP CO Ultra Installation Kit Swiss EDIZIOdue Compatible UP	Pure White (RAL 9010)	1711859-1
AMP CO Ultra Installation Kit Swiss EDIZIOdue Compatible UP	Black (RAL 9005)	1711859-2
AMP CO Ultra Installation Kit Swiss EDIZIOdue Compatible KNL	Black (RAL 9005)	1711858-3
AMP CO Ultra Installation Kit Swiss EDIZIOdue Compatible KNL	Pure White (RAL 9010)	1711858-4

AMP CO Ultra Installation Kit Swiss “Standard”

FEATURES

- Fast termination and easy assembly
- Shielded installation kit flush mount and surface mount
- Faceplate applicable to “Standard” systems
- Shielded edge connector for AWG 22-24 twisted pair cables
- Shielded housing with tangible screen termination
- Strain relief by cable tie
- Top, left or right cable entry
- 2.0 GHz performance



ORDERING INFORMATION

Description	Color	Part Number
AMP CO Ultra Installation Kit Swiss UP	Pure White (RAL 9010)	1711861-1
AMP CO Ultra Installation Kit Swiss AP	Pure White (RAL 9010)	1711862-1
AMP CO Ultra Installation Kit Swiss KNL	Pure White (RAL 9010)	1711864-1

AMP CO Ultra Installation Kit Swiss “FLF”

FEATURES

- Fast termination and easy assembly
- Shielded installation kit flush mount and surface mount
- Faceplate applicable to “FLF” systems
- Shielded edge connector for AWG 22-24 twisted pair cables
- Shielded housing with tangible screen termination
- Top, left or right cable entry (90°) and rear cable exit (180°)
- 2.0 GHz performance

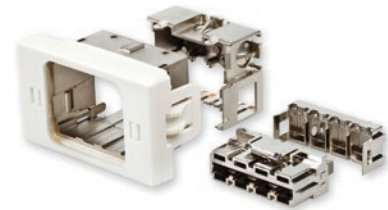

ORDERING INFORMATION

Description	Color	Part Number
AMP CO Ultra Installation Kit Swiss FLF, Cable exit 90°	Pure White (RAL 9010)	1711865-1
AMP CO Ultra Installation Kit Swiss FLF AP, Cable exit 90°	Pure White (RAL 9010)	1711866-1
AMP CO Ultra Installation Kit Swiss FLF, Cable exit 180°	Pure White (RAL 9010)	2153074-1
AMP CO Ultra Installation Kit Swiss FLF AP, Cable exit 180°	Pure White (RAL 9010)	2153075-1

AMP CO System

AMP CO Ultra Outlets

AMP CO Ultra Installation Kit 45 x 45

FEATURES

- Fast termination and easy assembly
- Shielded installation kit flush mount
- Faceplate 45 x 45 mm
- Shielded edge connector for AWG 22-24 twisted pair cables
- Shielded housing with tangible screen termination
- Strain relief by cable tie
- Top, left or right cable entry
- 2.0 GHz performance

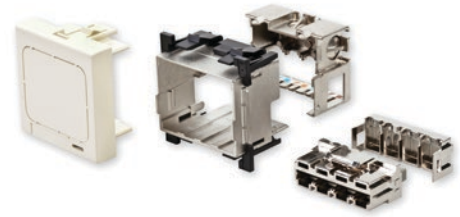

ORDERING INFORMATION

Description	Color	Part Number
AMP CO Ultra Installation Kit 45x45	Almond (RAL 1013)	1711860-1
AMP CO Ultra Installation Kit 45x45	Pure White (RAL 9010)	1711860-2
Adaptor Frame to 50 x 50 mm	Almond (RAL 1013)	1379156-1

AMP CO System

AMP CO Inserts

AMP CO Plus Category 7_A AMP-TWIST 7_{AS} Style Insert

FEATURES

- Exchangeable system insert for 1 x ISO Category 7_A (acc. IEC 61076-3-104)
- Class F_A, supports 1 GHz bandwidth
- Application: All services incl. 10 Gigabit Ethernet (10GBASE-T)

Pin out: EIA/TIA 568A; 8 pins, shielded

ORDERING INFORMATION

Description	Color	Part Number
Insert Cat. 7 _A AMP-TWIST 7 _{AS} Style	Almond (RAL 1013)	1711409-1
	Black (RAL 9005)	1711409-3
	Pure White (RAL 9010)	1711409-5

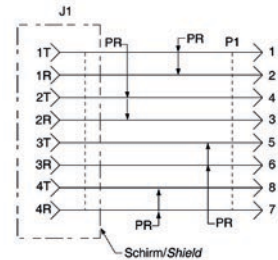

AMP CO Plus Category 7_A ARJ-45 Insert

FEATURES

- Exchangeable system insert for 1 x ISO Category 7_A (compatible with IEC 60603-7-7)
- Class F_A, supports 1 GHz bandwidth
- Application: All Ethernet services incl. 10 Gigabit Ethernet (10GBASE-T)

Pin out: EIA/TIA 568A; 8 pins, shielded

ORDERING INFORMATION

Description	Color	Part Number
Insert Cat. 7 _A ARJ-45	Almond (RAL 1013)	1711609-1
	Black (RAL 9005)	1711609-3
	Pure White (RAL 9010)	1711609-5



AMP CO Plus Category 7 Dual RJ-45 Insert for ATM

FEATURES

- Exchangeable system insert 2 x RJ-45
- Category 7 / Class F
- Application: 2 x ATM 622 MBit/s

Pin out: 12.78 + 12.78; 2 x 4 pins, shielded

ORDERING INFORMATION

Description	Color	Part Number
Insert 2 x RJ-45 Cat. 7	Almond (RAL 1013)	336556-1
	Black (RAL 9005)	336556-3
	Pure White (RAL 9010)	336556-5

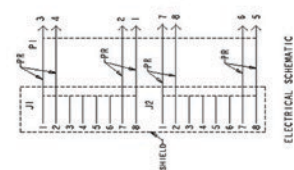

AMP CO System

AMP CO Inserts

AMP CO Plus Broadband Inserts for “Triple Play”

FEATURES

- Exchangeable system insert with F-series connector and 2 x RJ-45
- Application: 1 x CATV + 1 x Fast Ethernet (100BASE-TX) + 1x ISDN

Pin out: Balun 75Ω + 12.36 + 45; shielded



ORDERING INFORMATION

Description	Color	Part Number
Insert F-Series + 2 x RJ-45	Almond (RAL 1013)	1711336-1
	Black (RAL 9005)	1711336-3
	Pure White (RAL 9010)	1711336-5

AMP CO Plus Splitter Insert for Gigabit Ethernet and ISDN

FEATURES

- Exchangeable system insert 2 x RJ-45
- Application: 1 x Gigabit Ethernet (1000BASE-T) + 1x ISDN
- ITU I.430 services
- ISDN port is a 4 wire s-bus basic rate interface (BRI) including power feeding
- Two splitters required for system operation

Pin out: EIA/TIA 568 A: 8 pins, shielded

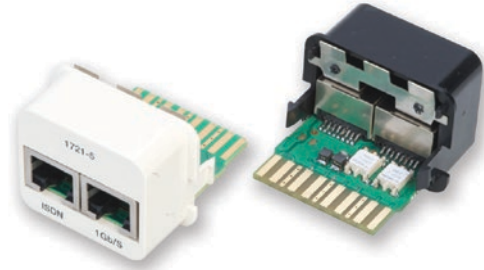

ORDERING INFORMATION

Description	Color	Part Number
Insert 2 x RJ-45 mixed	Almond (RAL 1013)	1591721-1
	Black (RAL 9005)	1591721-3
	Pure White (RAL 9010)	1591721-5

AMP CO Plus Category 6_A RJ-45 Insert for 10 Gigabit Ethernet

FEATURES

- Exchangeable system insert 1 x RJ-45
- Category 6_A / Class E_A
- Application: All Ethernet services incl. 10 Gigabit Ethernet (10GBASE-T) or ATM 1.2 GBit/s

Pin out: EIA/TIA 568A; 8 pins, shielded



ORDERING INFORMATION

Description	Color	Part Number
Insert 1 x RJ-45 Cat. 6 _A	Almond (RAL 1013)	1711796-1
	Black (RAL 9005)	1711796-3
	Pure White (RAL 9010)	1711796-5

AMP CO System

AMP CO Inserts

AMP CO Plus Category 6_A Dual RJ-45 Insert for Fast Ethernet

FEATURES

- Exchangeable system insert 2 x RJ-45
- Category 6_A / Class E_A
- Application: 2 x Fast Ethernet (100BASE-TX)

Pin out: 12.36 + 12.36; 2 x 4 pins, shielded

ORDERING INFORMATION

Description	Color	Part Number
Insert 2 x RJ-45 Cat. 6 _A Ethernet	Almond (RAL 1013)	1711801-1
	Black (RAL 9005)	1711801-3
	Pure White (RAL 9010)	1711801-5



AMP CO Plus Category 6_A Dual RJ-45 Insert for Fast Ethernet + Voice/Data

FEATURES

- Exchangeable system insert 2 x RJ-45
- Category 6_A / Class E_A
- Application: 1 x Fast Ethernet (100BASE-TX) + 1 x ISDN, xDSL or Token Ring

Pin out: 36.45 + 12.36; 2 x 4 pins, shielded

ORDERING INFORMATION

Description	Color	Part Number
Insert 2 x RJ-45 Cat. 6 _A mixed	Almond (RAL 1013)	1711804-1
	Black (RAL 9005)	1711804-3
	Pure White (RAL 9010)	1711804-5



AMP CO Plus Category 6_A Dual RJ-45 Insert for Voice/Data

FEATURES

- Exchangeable system insert 2 x RJ-45
- Category 6_A / Class E_A
- Application: 2 x ISDN, xDSL or Token Ring

Pin out: 36.45 + 36.45; 2 x 4 pins, shielded

ORDERING INFORMATION

Description	Color	Part Number
Insert 2 x RJ-45 Cat. 6 _A ISDN	Almond (RAL 1013)	1711807-1
	Black (RAL 9005)	1711807-3
	Pure White (RAL 9010)	1711807-5



AMP CO System

AMP CO Inserts

AMP CO Plus Category 6 RJ-45 Insert for 1 Gigabit Ethernet

FEATURES

- Exchangeable system insert 1 x RJ-45
- Category 6 / Class E
- Application: 1x Gigabit Ethernet (1000BASE-T), 1 x Fast Ethernet (100BASE-TX) or ATM 1.2 GBit/s

Pin out: EIA/TIA 568A; 8 pins, shielded

ORDERING INFORMATION

Description	Color	Part Number
Insert 1 x RJ-45 Cat. 6	Almond (RAL 1013)	336548-1
	Black (RAL 9005)	336548-3
	Pure White (RAL 9010)	336548-5

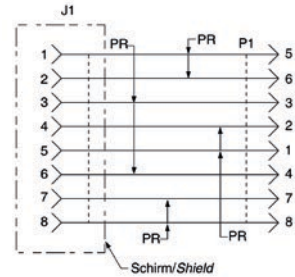

AMP CO Plus Category 5e RJ-45 Insert for Gigabit Ethernet

FEATURES

- Exchangeable system insert 1 x RJ-45
- Category 5e / Class D
- Application: 1x Gigabit Ethernet (1000BASE-T) or 1 x Fast Ethernet (100BASE-TX)

Pin out: EIA/TIA 568 A; 8 pins, shielded

ORDERING INFORMATION

Description	Color	Part Number
Insert 1 x RJ-45 Cat. 5e	Almond (RAL 1013)	284584-1
	Black (RAL 9005)	284584-3
	Pure White (RAL 9010)	284584-5

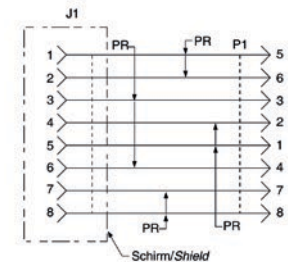

AMP CO Plus Category 5e Dual RJ-45 Insert for Fast Ethernet

FEATURES

- Exchangeable system insert 2 x RJ-45
- Category 5e / Class D
- Application: 2 x Fast Ethernet (100 Base-TX)

Pin out: 12.36 + 12.36; 2 x 4 pins, shielded

ORDERING INFORMATION

Description	Color	Part Number
Insert 2 x RJ-45 Cat. 5e Ethernet	Almond (RAL 1013)	183636-1
	Black (RAL 9005)	183636-3
	Pure White (RAL 9010)	183636-5

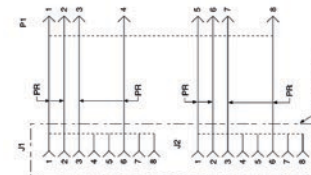

AMP CO System

AMP CO Inserts

AMP CO Plus Category 5e Dual RJ-45 Insert for Fast Ethernet + Voice/Data

FEATURES

- Exchangeable system insert 2 x RJ-45
- Category 5e / Class D
- Application: 1 x Fast Ethernet (100BASE-TX) + 1 x ISDN, xDSL or Token Ring

Pin out: 36.45 + 12.36; 2 x 4 pins, shielded

ORDERING INFORMATION

Description	Color	Part Number
Insert 2 x RJ-45 Cat. 5e mixed	Almond (RAL 1013)	183641-1
	Black (RAL 9005)	183641-3
	Pure White (RAL 9010)	183641-5

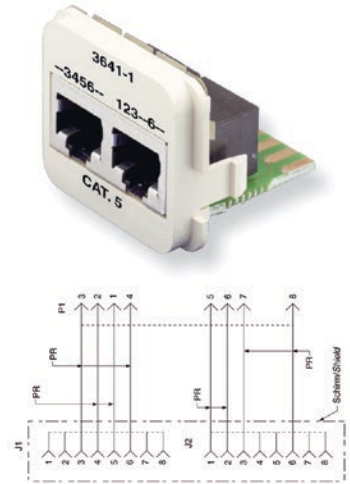

AMP CO Plus Category 5e Dual RJ-45 Insert for Voice/Data

FEATURES

- Exchangeable system insert 2 x RJ-45
- Category 5e / Class D
- Application: 2 x ISDN, xDSL or Token Ring

Pin out: 36.45 + 36.45; 2 x 4 pins, shielded

ORDERING INFORMATION

Description	Color	Part Number
Insert 2 x RJ-45 Cat. 5e ISDN	Almond (RAL 1013)	183635-1
	Black (RAL 9005)	183635-3
	Pure White (RAL 9010)	183635-5

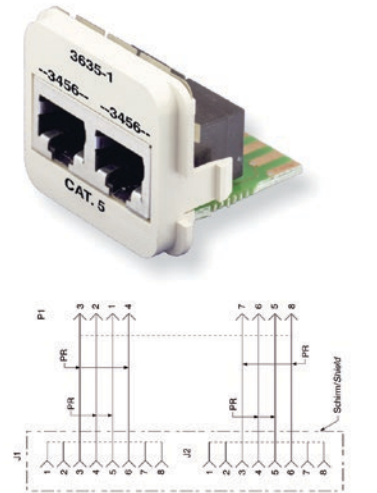

AMP CO Plus Dual Patch Panel Insert PoE Power Conversion

FEATURES

- Exchangeable system insert 2 x RJ-45
- Converts IEEE 802.3af mode B input to mode A output
- Uses Power Mux/Demux Technology
- For use with midspan units providing power over unused pairs
- Application: 2 x PoE (input mode independent), e.g. VoIP, over a 4 pair cable (sheath sharing)

ORDERING INFORMATION

Description	Color	Part Number
Insert 2 x PoE Power Conversion	Almond (RAL 1013)	1711125-1
	Black (RAL 9005)	1711125-3
	Pure White (RAL 9010)	1711125-5

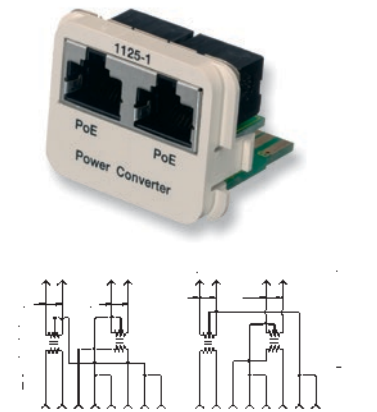

AMP CO System

AMP CO Inserts

AMP CO Plus Dual Insert PoE Mode A

FEATURES

- Exchangeable system insert 2 x RJ-45
- 2 x PoE IEEE 802.3af Mode A
- For use in outlet or with phantom power midspan units
- Application: 2 x PoE, e.g. VoIP, over a 4 pair cable (sheath sharing)

Pin out: 12.36 + 12.36; 2 x 4 pins; shielded

ORDERING INFORMATION

Description	Color	Part Number
Insert 2 x PoE Mode A	Almond (RAL 1013)	1711135-1
	Black (RAL 9005)	1711135-3
	Pure White (RAL 9010)	1711135-5

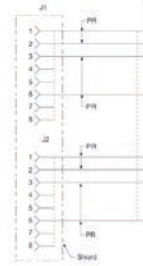

AMP CO Plus 3-Port Insert Standard Phones

FEATURES

- Exchangeable system insert 3 x RJ-45
- 1 x Category 6 / Class E + 2 x Category 3 / Class C
- Application: 1 x Fast Ethernet (100BASE-TX) + 2 x Phones (2 wire use)

Pin out: 12.36 + 45 + 45; 1 x 4 pins shielded and 2 x 2 pins unshielded

ORDERING INFORMATION

Description	Color	Part Number
Insert 3 x RJ-45 for Standard phone	Almond (RAL 1013)	1711100-1
	Black (RAL 9005)	1711100-3
	Pure White (RAL 9010)	1711100-5

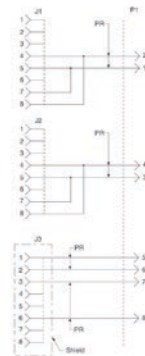

AMP CO Plus 3-Port Insert Shunt Phones

FEATURES

- Exchangeable system insert 3 x RJ-45
- 1 x Category 6 / Class E + 2 x Category 3 / Class C
- Application: 1 x Fast Ethernet (100BASE-TX) + 2 x Phones (parallel use)

Pin out: 12.36 + 36.45 + 36.45; 1 x 4 pins shielded and 2 x 4 pins unshielded

ORDERING INFORMATION

Description	Color	Part Number
Insert 3 x RJ-45 for Shunt phone	Almond (RAL 1013)	1711450-1
	Black (RAL 9005)	1711450-3
	Pure White (RAL 9010)	1711450-5

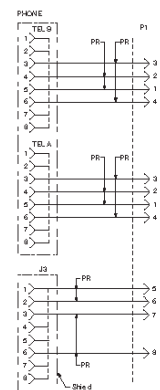

AMP CO System

AMP CO Inserts

AMP CO Plus 4 Pair Sub-D 9pos Insert

FEATURES

- Exchangeable system insert 1 x Sub-D 9pos
- Includes M3 nuts for locking

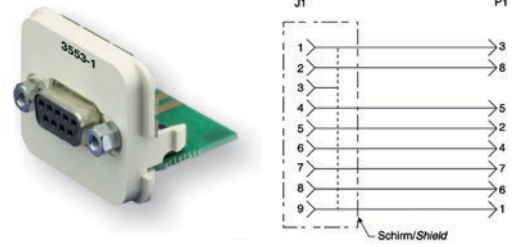

ORDERING INFORMATION

Description	Color	Part Number
Insert Sub-D 9pos	Almond (RAL 1013)	183553-1

AMP CO Inserts for Voice Applications

FEATURES

- Exchangeable system insert 2 x or 4 x RJ-11 or RJ-45
- 2 x or 4 x Category 3 / Class C
- Application: ISDN, So or UpN



ORDERING INFORMATION

Description	Shielded	Terminated	Part Number	-X	Color
Insert 2 x RJ-45; Use at: outlet/panel; Note: French version	Yes	No	183578-1	-1	Almond (RAL 1013)
Insert 2 x RJ11; Use at: outlet; Note: panel side 284584-X	No	No	555614-1	-3	Black (RAL 9005)
Insert 4 x RJ-45; Use at: outlet/panel; Note: French version	No	No	1644016-X	-5	Pure White (RAL 9010)
Insert 4 x RJ-45; Use at: outlet/panel; Note: panel + outlet	No	No	1711000-X		
Insert 4 x RJ-45; Use at: outlet; Note: panel side 183635-X	No	100Ω	1711001-X		
Insert 2 x RJ-45 parallel; Use at: outlet; Note: panel side 284584-X	No	No	1711339-1		

AMP CO Plus Blank Insert

FEATURES

- Blank insert
- Dust protection for unused ports



ORDERING INFORMATION

Description	Color	Part Number
Blank Insert	Almond (RAL 1013)	555644-1
	Black (RAL 9005)	555644-3
	Grey (RAL 7035)	555644-5
	Pure White (RAL 9010)	555644-9

AMP CO System

AMP CO Tools & Accessories

AMP CO Ultra Pistol-Grip Tool

FEATURES

- Pistol grip tool for fast and easy termination of AMP CO Ultra modules
- Ensures repeatable high termination quality
- Considerable reduction of termination time
- Including adapter piece for termination of AMP CO Ultra modules
- AMP CO Ultra Tool Adapter-Gauge and Blade are also available as spare parts



ORDERING INFORMATION

Description	Part Number
AMP CO Ultra Pistol-Grip Tool	1711500-1
AMP CO Ultra Tool Adapter-Gauge	2153264-1
AMP CO Ultra Tool Blade	2153117-1

AMP CO Plus Edge Connector

FEATURES

- Shielded edge connector for AWG 22-24 twisted pair cables
- 2.0 GHz performance
- 110C compatible IDC block
- Universal color code
- Fully shielded

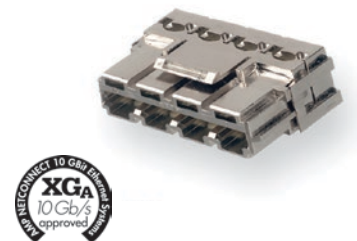

ORDERING INFORMATION

Description	Quantity	Part Number
AMP CO Plus Edge Connector	100 pieces	336455-1
	8 pieces	336455-2
	10 pieces	336455-3

Printer Labels for AMP CO Installation Kits

FEATURES

- Self-adhesive A4 sheets with printer labels for AMP CO Installation Kits
- Uses standard MS Excel sheet

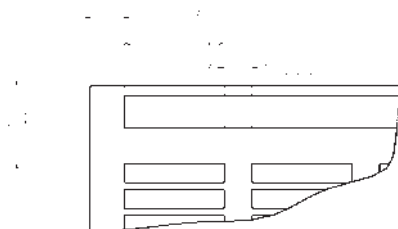

ORDERING INFORMATION

Description	Part Number
Labels (6 x 32 mm, 170 pcs per sheet); Packaging 10 sheets	969704-1

11. Fiber Optic Cabling

System Cable	158
Patch Panels	167
Accessories for Patch Panels	171
Quick-Fit Modules.....	173
Wall Mount Enclosures.....	174
Snap-In Modules.....	176
Pre-assembled LC & SC Trunks.....	178
Patch Cords and Pigtailes.....	179
Outlets.....	187
Adaptors	190
LightCrimp and LightCrimp Plus	193
Epoxy Connectors	197
Splicing Products.....	200
Fiber Optic Tools.....	203
Fiber Cleaning and Inspection.....	216

Fiber Optic Cabling

System Cable

Technical Data

FIRE PERFORMANCE

Sheathing materials for internal cables comply fully with the following standards:

ASPECT

NORM

- Flammability
- Smoke emission
- Acid gas emission
- Toxicity
- IEC 60332 Parts 1 and 3
- IEC 61034 Parts 1 and 2
- IEC 60754 Parts 1 and 2
- NES 713

Drum Ref	Barrel (mm)	Flange (mm)	Traverse (mm)	Weight (kg)
P5	300	500	400	5.5
P6	300	600	400	7
P8	400	800	400	12.5
P10	400	1000	500	20
P12	400	1200	500	32
P14	700	1400	700	65
L (P17)	1000	1700	800	180
M (P20)	1200	2000	800	250
N (P22)	1200	2200	800	420

MULTIMODE FIBERS

ISO/IEC 11801 and EN 50173	Overfill Bandwidth (MHz x km)		Max. Link Length for 1 GBit/s (m)		Max. Link Length for 10 GBit/s (m)		Fiber Attenuation (dB/km)		
	850 nm	1300 nm	850 nm (1000Base-SX)	1300 nm (1000 Base-LX)	850 nm (10GBase-SR) (10GBase-SW)	1300 nm (10GBase-LX4)	850 nm	1300 nm	
OM1	62.5 μm	≥ 200	≥ 600	275	550*	33	360*	≤ 2.9	≤ 0.7
OM1 <i>Plus</i>	62.5 μm	≥ 250	≥ 800	400	1000*	65	450*	≤ 2.9	≤ 0.7
OM2	50 μm	≥ 500	≥ 500	550	550*	83	300*	≤ 2.4	≤ 0.6
OM2 <i>Plus</i>	50 μm	≥ 600	≥ 1200	750	2000*	150	1000*	≤ 2.4	≤ 0.6
OM3 (XG)	50 μm	≥ 1500	≥ 500	1000	600	300	300	≤ 2.4	≤ 0.6
OM4 (XG _A)	50 μm	≥ 3500	≥ 500	1040	600	550**	300	≤ 2.4	≤ 0.6

* Mode conditioning patchcords required

** According to the IEEE 10Gb Ethernet model

SINGLEMODE FIBERS

ISO/IEC 11801 and EN 50173	Chromatic Dispersion (ps/nm x km)		Cut-off Wavelength, cabled	Point Discontinuity	Fiber Attenuation (dB/km)		
	1310 nm	1550 nm	(nm)	(dB)	1310 nm	1380-1386 nm	1550 nm
OS2 (ITU-T G.652D)	≤ 3.5	≤ 18,0	≤ 1260	≤ 0.05	≤ 0.34	≤ 0.34	≤ 0.22

GEOMETRICAL FIBER PROPERTIES

Fiber Type	Core/Mode-field (nm)	Cladding (nm)	Coating (nm)
OM1, OM1 <i>Plus</i>	62.5 ± 3	125 ± 2	245 ± 10
OM2, OM2 <i>Plus</i> , OM3(XG), OM4(XG _A)	50 ± 2.5	125 ± 2	245 ± 5
OS2	9.2 ± 0.4	125 ± 1	245 ± 5



For all OM4 XG_A System Cables

OPTICAL CABLE SPECIFICATIONS

Maximum Attenuation (dB/km)

	Loose Tube/Dry Tube		Tight Buffered	
	850 nm	1300 nm	850 nm	1300 nm
Multimode				
50/125	2.5	0.7	2.5	0.7
62.5/125	2.9	0.9	2.7	0.9
Singlemode				
OS2	1310 nm	1550 nm	1310 nm	1550 nm
	0.4	0.25	0.4	0.25

NOTE: For higher fiber performance please contact our local sales teams.

Fiber Optic Cabling

System Cable

Zip Twin and Mini Zip Twin Cable

FEATURES

- Low Smoke Zero Halogen (LSZH)
- Available buffer designs:
 - Zip Twin: Tight-Buffer (900µm)
 - Mini Zip Twin: Tight-Buffer (600µm)
- Fiber categories: OM1, OM1 **Plus**, OM2, OM2 **Plus**, OM3 **XG**, OM4 **XG_A**, OS2
- Tight buffer versions suitable for TE CONNECTIVITY Quick Termination Products (i.e. LightCrimp or LightCrimp Plus)

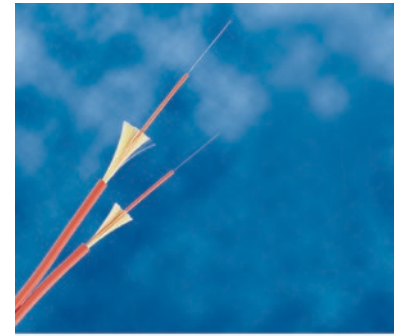
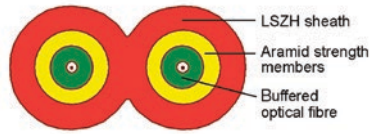

Y-	Reel size	-X	Fiber category
1-	1 Kilometer	-2	OM4 XG_A
2-	2 Kilometer	-3	OM3 XG
3-	3 Kilometer	-4	OS2
4-	4 Kilometer	-5	OM1
		-6	OM2 Plus
		-7	OM2
		-9	OM1 Plus

ORDERING INFORMATION

Description	Part Number
Fiber count: 2; Cable type: Zip Twin TB (Tight Buffered Construction)	Y-599142-X
Fiber count: 2; Cable type: Mini Zip Twin TB (Tight Buffered Construction)	Y-6206650-X

MECHANICAL PERFORMANCE

Fiber count	Overall Ø (mm)	Weight (kg/km)	Installation tension max. during installation (N)	Crush resistance (N)	Minimum bend radius during installation (mm)
ZipTwin	2.5 x 5.0	14	300	1000	40
Mini Zip Twin	1.8 x 3.75	6.6	220	2000	25

TEMPERATURE RANGE

Cable type	Transport/Storage	Installation	Operation
Zip Twin, Mini Zip Twin	- 10 to + 70 °C	- 5 to + 70 °C	- 10 to + 70 °C

PACKAGING

For drum size see page 158

Cable Type	1km	2km	3km	4km
Zip Twin	P5	P5	P6	P6
Mini Zip Twin	P5	P5	P5	P5

Fiber Optic Cabling

System Cable

Internal Microtube Cable

FEATURES

- Compact construction for optimum space utilisation
- Totally non-metallic – light and easy to install
- ULSZH flame retardant outer jacket
- Sub units and fibers color coded according to TIA/EIA-569
- Crush resistance : 1000 N
- Impact resistance : 2J

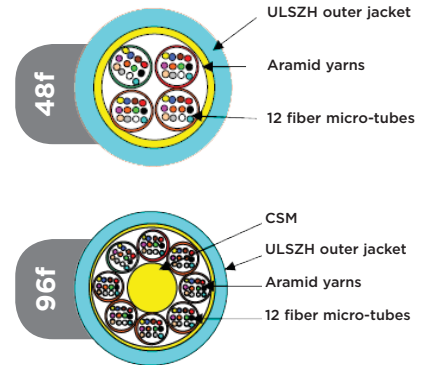
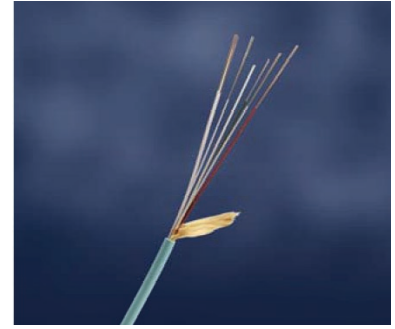

ORDERING INFORMATION

Description	Fiber Type	Y-	Reel size	-X	Fiber category
Fiber count: 8	Y-1716293-X	2-	2 Kilometers	-2	OM4 XG _A
Fiber count: 12	Y-1716294-X			-3	OM3 XG
Fiber count: 24	Y-1716295-X			-4	OS2
Fiber count: 36	Y-1716296-X			-7	OM2
Fiber count: 48	Y-1716297-X				
Fiber count: 60	Y-1716298-X				
Fiber count: 72	Y-1716299-X				
Fiber count: 96	Y-1716300-X				
Fiber count: 144	Y-1716301-X				

MECHANICAL PERFORMANCE

Fiber count	No. of tubes/fillers	Nominal cable diameter (mm)	Nominal weight (kg/km)	Tensile strength (N)	Min. installation bend radius (mm)	Combustion energy (MJ/m)
8/12	1/3	5.0	23	700	60	0.35
24	2/2	5.0	23	700	60	0.35
36	3/1	5.0	23	700	60	0.33
48	4	5.0	23	700	60	0.30
60	5/1	6.1	34	1250	70	0.48
72	6	6.1	34	1250	70	0.45
96	8	6.8	45	1500	70	0.57
144	12	8.6	70	1500	100	0.93

TEMPERATURE RANGE

Cable type	Transport/Storage	Installation	Operation
Internal Microtube Cable	-40°C to 70°C	- 5 to + 60 °C	- 20 to + 70 °C

PACKAGING

Fiber count	2km
8-48	P6
60-72	P8
96	P8
144	P10

Fiber Optic Cabling

System Cable

Internal/External Office Distribution Cable

FEATURES

- Universal Low Smoke Zero Halogen (ULSZH)
- For indoor and outdoor applications
- Suitable for backbone and Fiber-to-the-Desk
- Increased strength and durability
- Tight-Buffer construction
- Suitable for all termination techniques
- Fiber categories: OM1, OM1 *Plus*, OM2, OM2 *Plus*, OM3 XG, OM4 XG_A, OS2
- Aramid strength members

ORDERING INFORMATION

Description	Part Number	Y-	Reel size	-X	Fiber category
Fiber count: 4	Y-599144-X	1-	1 Kilometer	-2	OM4 XG _A
Fiber count: 6	Y-599145-X	2-	2 Kilometers	-3	OM3 XG
Fiber count: 8	Y-599146-X	3-	3 Kilometers	-4	OS2
Fiber count: 12	Y-599148-X	4-	4 Kilometers	-5	OM1
Fiber count: 16	Y-599149-X			-6	OM2 Plus
Fiber count: 24	Y-1716029-X			-7	OM2
Fiber count: 36	Y-599602-X			-9	OM1 Plus
Fiber count: 48	Y-599603-X				

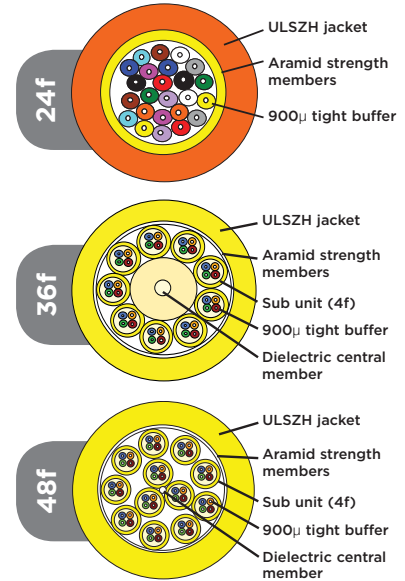
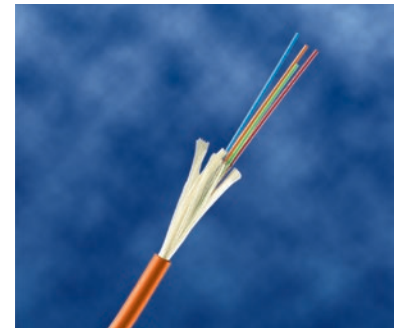

MECHANICAL PERFORMANCE

Fiber count	Overall Ø (mm)	Weight (kg/km)	Installation tension max. during installation (N)	Crush resistance (N)	Combustion Energy (MJ/m)	Minimum bend radius during installation (mm)
4	5	27	650	2000	0.424	75
6	6	33	1000	2000	0.714	90
8	6	35	1000	2000	0.742	90
12	7.5	56	1000	2000	0.953	115
16	8	61	1000	2000	1.175	120
24	9.5	80	1000	2000	1.513	240
36	17	280	2000	2000	6.199	430
48	17.3	230	2000	2000	6.018	430

TEMPERATURE RANGE

Cable type	Transport/Storage	Installation	Operation
Office Distribution Cable	- 20 to + 70 °C	- 5 to + 50 °C	- 10 to + 70 °C

PACKAGING

For drum size see page 158

Fiber count	1km	2km	3km	4km
4	P5	P6	P8	P8
6,8	P6	P8	P8	P10
12	P8	P10	P10	P10
16	P8	P10	P10	P10
24	P10	P10	P12	P12
36,48	P12	P14	P17	P20

Fiber Optic Cabling

System Cable

Internal/External Loose Tube Cable

FEATURES

- Universal Low Smoke Zero Halogen (ULSZH)
- For indoor and outdoor applications
- Loose tube construction
- Dry tube construction also available
- Suitable for all termination techniques
- Fiber categories: OM1, OM1 *Plus*, OM2, OM2 *Plus*, OM3 *XG*, OM4 *XG_A*, OS2
- Aramid strength members

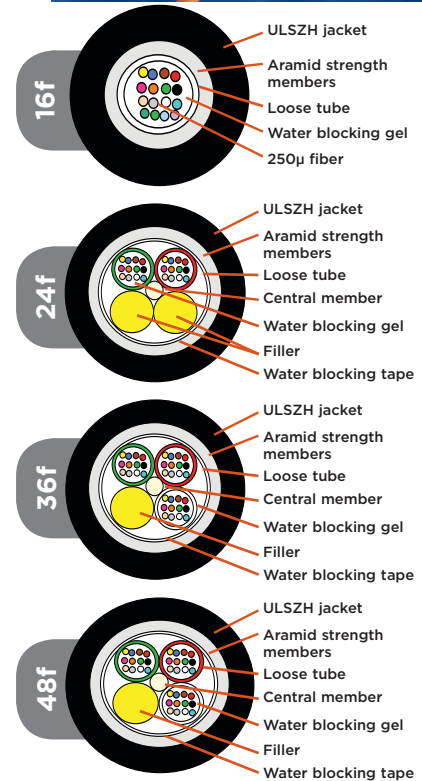
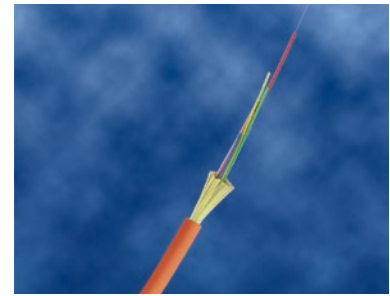

ORDERING INFORMATION

Description	Gel filled tube version Part Number	Dry tube version Part Number	Y-	Reel size
Fiber count: 4	Y-599160-X	Y-599152-X	1-	1 Kilometer
Fiber count: 6	Y-599161-X	Y-599153-X	2-	2 Kilometer
Fiber count: 8	Y-599162-X	Y-599154-X	3-	3 Kilometer
Fiber count: 12	Y-599164-X	Y-599156-X	4-	4 Kilometer
Fiber count: 16	Y-599165-X	Y-599157-X		
Fiber count: 24 (multi-tube)	Y-599167-X	Y-599159-X	-X Fiber category	
Fiber count: 24 (uni-tube)	Y-1716000-X	-	-2	OM4 <i>XG_A</i>
Fiber count: 48	Y-599609-X	Y-599605-X	-3	OM3 <i>XG</i>
Fiber count: 72	Y-599610-X	Y-599606-X	-4	OS2
Fiber count: 96	Y-599611-X	Y-599607-X	-5	OM1
			-6	OM2 <i>Plus</i>
			-7	OM2
			-9	OM1 <i>Plus</i>

MECHANICAL PERFORMANCE

Fiber count	No. of tubes/fillers	Overall Ø (mm)	Weight (kg/km)	Installation tension max. during installation (N)	Crush resistance (N)	Combustion Energy (MJ/m)	Minimum bend radius during installation (mm)
4, 6, 8, 12	1	6.4	33	500	2000	0.886	140
16, 24	1	7.5	44	500	2000	1.65	150
24, 48	4	11.5	125	1000	2000	3.35	170
72	6	12.7	155	2700	2000	4.302	250
96	8	15	210	2700	2000	6.076	300

TEMPERATURE RANGE

Cable type	Transport/Storage	Installation	Operation
Dry, loose tube	- 10 to + 60 °C	- 5 to + 50 °C	- 10 to + 60 °C
Gel filled, loose tube	- 20 to + 60 °C	- 5 to + 50 °C	- 20 to + 60 °C

PACKAGING

For drum size see page 158

Fiber count	1km	2km	3km	3km
4,6,8,12	P8	P8	P10	P10
16, 24 uni	P8	P10	P10	P10
24 multi, 48	P12	P12	P12	P14
72	P12	P12	P14	P17
96	P12	P14	P17	P17

Fiber Optic Cabling

System Cable

Internal/External Loose Tube System Cable with non-metallic rodent resistance

FEATURES

- Universal Low Smoke Zero Halogen (ULSZH)
- LLDPE (Linear Low Density Polyethylene) sheath
- For indoor and outdoor applications
- For use in ducts and direct burial applications
- Non-metallic rodent resistant with peripheral strength members
- Water blocking E-glass yarn (moisture protection)
- Loose tube construction
- Dry tube construction also available
- Suitable for all termination techniques
- Fiber categories:
 - OM1, OM1 Plus, OM2, OM2 Plus, OM3 XG, OM4 XGA, OS2

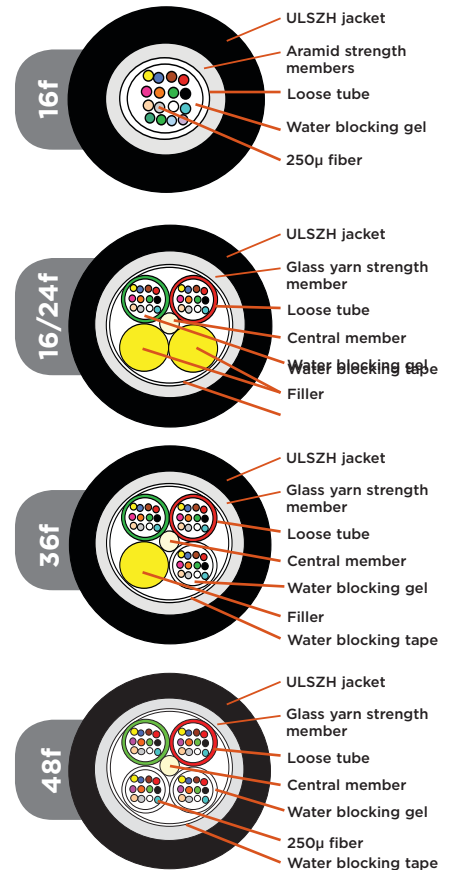

ORDERING INFORMATION

Description	Gel filled tube version Part Number	Dry tube version Part Number
Fiber count: 4	Y-599622-X	Y-599614-X
Fiber count: 6	Y-599623-X	Y-599615-X
Fiber count: 8	Y-599624-X	Y-599616-X
Fiber count: 12	Y-599625-X	Y-599617-X
Fiber count: 16	Y-599626-X	Y-599618-X
Fiber count: 24 (multi-tube)	Y-599627-X	Y-599619-X
Fiber count: 24 (uni-tube)	Y-1716001-X	-
Fiber count: 36	Y-599628-X	Y-599620-X
Fiber count: 48	Y-599629-X	Y-599621-X

Y-	Reel size
1-	1 Kilometer
2-	2 Kilometer
3-	3 Kilometer
4-	4 Kilometer

-X	Fiber category
-2	OM4 XG _A
-3	OM3 XG
-4	OS2
-5	OM1
-6	OM2 <i>Plus</i>
-7	OM2
-9	OM1 <i>Plus</i>

MECHANICAL PERFORMANCE

Fiber count	No. of tubes/fillers	Overall Ø (mm)	Weight (kg/km)	Installation tension max. during installation (N)	Crush resistance (N)	Combustion Energy (MJ/m)	Minimum bend radius during installation (mm)
4, 6, 8, 12	1	6.4	48	1250	1000	0.677	140
16, 24	1	8	74	1250	1000	1.271	160
24, 36, 48	4	11.5	105	2000	2000	3.171	230

TEMPERATURE RANGE

Cable type	Transport/Storage	Installation	Operation
Dry, loose tube	- 10 to + 70 °C	- 5 to + 50 °C	- 10 to + 70 °C
Gel filled, loose tube	- 20 to + 70 °C	- 5 to + 50 °C	- 20 to + 70 °C

PACKAGING

For drum size see page 158

Fiber count	1km	2km	3km	4km
4, 6, 8, 12	P8	P8	P10	P10
16, 24 uni	P8	P10	P10	P10
24 multi, 36, 48	P12	P12	P12	P14

Fiber Optic Cabling

System Cable

External Rodent Resistant Loose Tube System Cable with Non-Metallic Armour

FEATURES

- Universal Low Smoke Zero Halogen (ULSZH)
- LDPE sheath upon request
- For external applications where increased resistance to rodent attack is required
- For use in ducts and direct burial applications
- Longitudinal and lateral water resistance
- High crush resistance and high tensile strength
- Non-metallic rodent resistant Glass Reinforced Plastic armouring
- Gel filled loose tube construction
- Suitable for all termination techniques
- Fiber categories: OM1, OM1 Plus, OM2, OM2 Plus, OM3 XG, OM4 XGA, OS2

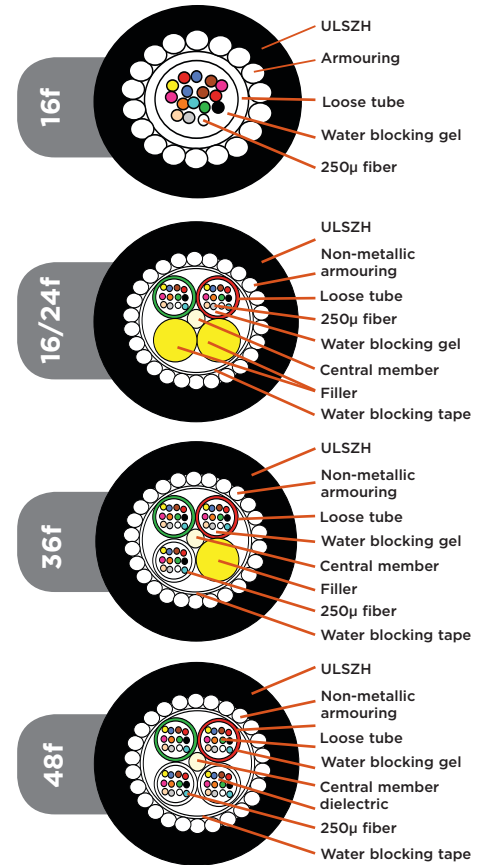
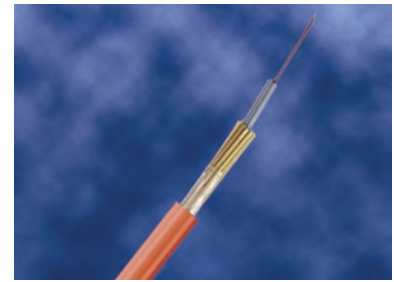

ORDERING INFORMATION

Description	Part Number
Fiber count: 4	Y-599168-X
Fiber count: 6	Y-599169-X
Fiber count: 8	Y-599170-X
Fiber count: 12	Y-599172-X
Fiber count: 16	Y-599173-X
Fiber count: 24	Y-599175-X
Fiber count: 36	Y-599612-X
Fiber count: 48	Y-599613-X

Y-	Reel size
1-	1 Kilometer
2-	2 Kilometer
3-	3 Kilometer
4-	4 Kilometer
-X	Fiber category
-2	OM4 XG_A
-3	OM3 XG
-4	OS2
-5	OM1
-6	OM2 Plus
-7	OM2
-9	OM1 Plus

MECHANICAL PERFORMANCE

Fiber count	No of tubes/fillers	Overall Ø (mm)	Weight (kg/km)	Installation tension max. during installation (N)	Crush resistance (N)	Combustion Energy (MJ/m)	Minimum bend radius during installation (mm)
4, 6, 8, 12	1	9	94	2000	3000	1.973	230
16	1	11	143	3000	3000	3.038	280
24, 36, 48	4	15	236	6000	4000	4.671	465

TEMPERATURE RANGE

Cable type	Transport/Storage	Installation	Operation
Single tube	- 20 to + 70 °C	- 5 to + 50 °C	- 20 to + 70 °C
Multi tube	- 30 to + 70 °C	- 5 to + 50 °C	- 30 to + 70 °C

PACKAGING

For drum size see page 158

Fiber count	1km	2km	3km	4km
4, 6, 8, 12	P8	P10	P10	P12
16	P10	P12	P12	P14
24, 36, 48	P12	P14	P17	P17

Fiber Optic Cabling

System Cable

External Rodent Resistant Loose Tube System Cable with corrugated steel armour

FEATURES

- LLDPE (Linear Low Density Polyethylene)
- Metallic rodent resistant (corrugated steel)
- For use in ducts and in direct burial applications
- Longitudinal and lateral water resistance
- Central gel-filled loose tube construction
- Excellent crush and impact resistance
- Suitable for all termination techniques
- Fiber categories: OM1, OM1 Plus, OM2, OM2 Plus, OM3 XG, OM4 XGA, OS2
- Option: ULSZH sheath for internal and external applications

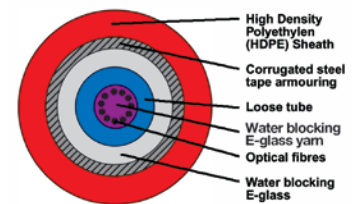
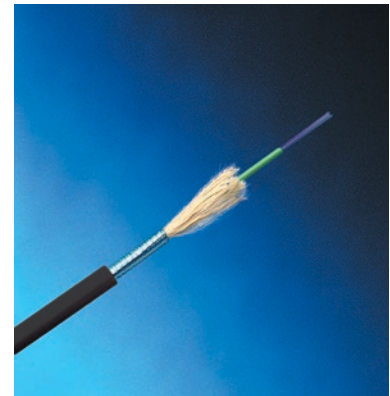

ORDERING INFORMATION

Description	Part Number
Fiber count: 4	Y-599681-X
Fiber count: 6	Y-599682-X
Fiber count: 8	Y-599692-X
Fiber count: 12	Y-599683-X
Fiber count: 24	Y-599690-X

Y-	Reel size	-X	Fiber category
1-	1 Kilometer	-2	OM4 XG _A
2-	2 Kilometer	-3	OM3 XG
3-	3 Kilometer	-4	OS2
4-	4 Kilometer	-5	OM1
		-6	OM2 <i>Plus</i>
		-7	OM2
		-9	OM1 <i>Plus</i>

MECHANICAL PERFORMANCE

Fiber count	No. of tubes/fillers	Overall Ø (mm)	Weight (kg/km)	Installation tension max. during installation (N)	Crush resistance (N)	Minimum bend radius during installation (mm)
4, 6, 8, 12	1	10	104	1250	3000	200
24	1	10.5	120	1250	3000	200

TEMPERATURE RANGE

Cable type	Transport/Storage	Installation	Operation
Gel filled, loose tube	- 20 to + 70 °C	- 5 to + 50 °C	- 20 to + 70 °C

PACKAGING

For drum size see page 158

Fiber count	1km	2km	3km	4km
4, 6, 8, 12	P10	P10	P12	P12
24	P10	P12	P12	P14

Fiber Optic Cabling

System Cable

Internal/External Fire Survival Loose Tube Cable

FEATURES

- Circuit Integrity for 90 minutes at 750°C (following IEC 60331-25)
- Low Smoke Zero Halogen (LSZH)
- For use in ducts and direct burial applications
- Longitudinal and lateral water resistance
- Metallic CST armour between 2 jackets provides excellent crush resistance
- Gel filled loose tube construction
- Suitable for all termination techniques
- Fiber categories: OM1, OM1 Plus, OM2, OM2 Plus, OM3 XG, OM4 XGA, OS2

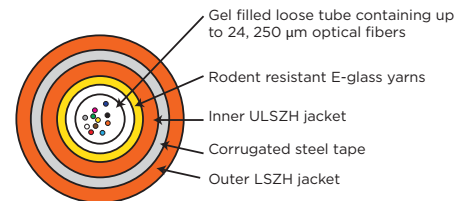
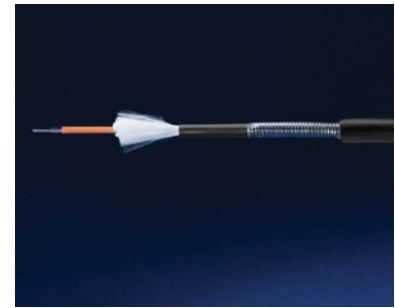

ORDERING INFORMATION

Description	Part Number
Fiber count: 4	Y-1716219-X
Fiber count: 6	Y-1716218-X
Fiber count: 8	Y-1716217-X
Fiber count: 12	Y-1716211-X
Fiber count: 16	Y-1716220-X
Fiber count: 24	Y-1716216-X

Y-	Reel size	-X	Fiber category
1-	1 Kilometer	-2	OM4 XG_A
2-	2 Kilometer	-3	OM3 XG
3-	3 Kilometer	-4	OS2
4-	4 Kilometer	-5	OM1
		-6	OM2 Plus
		-7	OM2
		-9	OM1 Plus

MECHANICAL PERFORMANCE

Fiber count	Overall Ø (mm)	Weight (kg/km)	Installation tension max. during installation (N)	Crush resistance (N)	Combustion Energy (MJ/m)	Minimum bend radius during installation (mm)
4, 6, 8, 12, 16, 24	12.7	216	1400	3000	6.2	255

TEMPERATURE RANGE

Cable type	Transport/Storage	Installation	Operation
Fire Survival Cable	-20 to +70 C	-5 to +50 C	-20 to +70C

PACKAGING

For drum size see page 158

Fiber count	1km	2km	3km	4km
4, 6, 8, 12, 16, 24	P12	P10	P14	P17

Fiber Optic Cabling

Patch Panels

Angled modular fiber optic panel

FEATURES

- Drawer style, 1U, 19"
- Plexi transparent cover
- 4 Quick-Fit cutouts
- One pin splice tray fixation (splice tray NOT included)

Color: black (RAL 9005)



ORDERING INFORMATION

Description	Part Number
Angled modular FO panel	1-1671260-1

1U Modular fiber optic panel flushmount style

FEATURES

- Drawer style, 1U, 19"
- Exchangeable adaptor panels (to be ordered separately)
- Unloaded and half-loaded (12 adaptors) panels available on request
- ST-style loaded adaptor panels available on request
- Plexi transparent cover
- Pull-out labeling strip
- Cable entrance by means of cable termination kit with glands (PN 1671273-1) or cable termination kit with flex tube (PN 1671274-1) in case of limited space in the back see accessories page 190
- Maximum 2 Splice Trays can be stored in the panel (2 x 24 = 48 splices)
- One pin Splice Tray fixation (splice tray NOT included)
- For splicing accessories see page 200 for cable management see page 171



ORDERING INFORMATION

Description	Part Number
Modular fiber panel - drawer; Color: black (RAL 9005)	1-1671262-1
Modular fiber panel - drawer with pre-installed adaptor panel for 4 Quick-Fit modules; color: black (RAL 9005)	1-1671365-1
Adaptor panel with 24 x SC duplex; Color: black (RAL 9005)	2-1671268-X
Adaptor panel with 24 x LC duplex; Color: black (RAL 9005)	2-1671271-X
Adaptor panel for 4 Quick-Fit modules; Color: black (RAL 9005)	1671263-1
Modular fiber panel - drawer; Color: grey (RAL 7035)	1-1671262-2
Adaptor panel with 24 x SC duplex; Color: grey (RAL 7035)	2-1671269-X
Adaptor panel with 24 x LC duplex; Color: grey (RAL 7035)	2-1671272-X
Adaptor panel for 4 Quick-Fit modules; Color: grey (RAL 7035)	1671263-2

-X	Fiber type	Color
-1	OM1	beige
-2	OM2	black
-3	OM3	aqua
-4	OS2	blue

Fiber Optic Cabling

Patch Panels

1U - LC, SC, ST-Style patch panel, international version

FEATURES

- Drawer style, 1U, 19"
- Preinstalled dust covers on unpopulated ports
- Incl. management rings and metric glands
- Available in 300 mm and 220 mm depth
- Available in ST-Style, SC and LC
- Supplied without splicing tray

Color: black (RAL 9005)



ORDERING INFORMATION

Description	220 mm Part Number	300 mm Part Number
24 x ST-Style, Multimode and Singlemode; Unpopulated	1206480-8	1206114-8
24 x ST-Style, Multimode; With 12 adapters	2-1206480-4	2-1206114-4
24 x ST-Style, Multimode; With 24 adapters and pigtails (OM2)	-	4-1206114-0
24 x ST-Style, Multimode; With 24 adapters	4-1206480-4	4-1206114-4
12 x SC Duplex, Multimode and Singlemode; unpopulated	1206505-8	1206138-8
12 x SC Duplex, Multimode; With 6 adapters	2-1206505-4	2-1206138-4
12 x SC Duplex, Multimode; With 12 adapters and 24 pigtails (OM3)	-	4-1206138-0
12 x SC Duplex, Multimode; With 12 adapters	4-1206505-4	4-1206138-4
24 x SC Duplex, Multimode and Singlemode; Unpopulated	-	1206343-4
24 x SC Duplex, Multimode; with 24 adapters	-	4-1206343-4
24 x SC Duplex, Singlemode; with 24 adapters	-	4-1671002-4
12 x SC Duplex, Singlemode; With 6 adapters	2-1671017-4	2-1348960-4
12 x SC Duplex, Singlemode; With 12 adapters and 24 pigtails (OS2)	-	4-1348960-0
12 x SC Duplex, Singlemode; With 12 adapters	4-1671017-4	4-1348960-4
24 x LC Duplex, Multimode and Singlemode; unpopulated	-	1671000-8
24 x LC Duplex, Singlemode; With 12 adapters	-	2-1671000-4
24 x LC Duplex, Multimode; With 12 adapters	-	2-1671000-8
24 x LC Duplex, Singlemode; with 24 adapters	-	4-1671000-4
24 x LC duplex, Multimode, with 12 adaptors AQUA	-	2-1671000-2
24 x LC Duplex, Multimode; With 24 adapters	-	4-1671000-8
24 x LC duplex, Multimode; with 24 adaptors AQUA	-	4-1671000-2

Fiber Optic Cabling

Patch Panels

1U - LC, SC, ST-Style patch panel, German version

FEATURES

- 1U, 19", metal, Supplied with ANT splicing trays
- Pre-installed adapters
- Pre-installed dust covers on unpopulated ports
- Alignment sleeve material: Multimode = Metal;
Singlemode = Ceramic
- 2 rear cable entries
- Incl. 1 blindcover and 1 metric pre-installed cable entry plate (German version)
- Populated fix style versions comes with cable management rings

Color: light grey (RAL 7035)

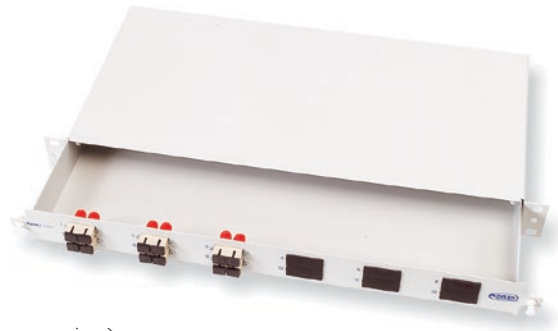

ORDERING INFORMATION

Description	Fix style Part Number	Drawer style Part Number
24 x LC Duplex/LC Duplex, unpopulated	1671121-8	1671130-8
24 x LC Duplex/LC Duplex, Multimode; With 24 adapters	4-1671121-8	4-1671130-8
24 x LC Duplex/LC Duplex, Multimode; With 12 adapters	2-1671121-4	2-1671130-8
24 x LC Duplex/LC Duplex, Singlemode; With 24 adapters	4-1671121-4	4-1671130-4
24 x LC Duplex/LC Duplex, Singlemode; With 12 adapters	2-1671121-4	2-1671130-4
24 x SC Duplex/SC Duplex; Unpopulated	1418734-1	1418735-1
12 x SC Duplex/SC Duplex; Unpopulated	969615-1	969994-1
12 x SC Duplex/SC Duplex, Multimode; With 12 adapters	1-969619-1	969631-1
12 x SC Duplex/SC Duplex, Multimode; With 6 adapters	1-969617-1	969629-1
12 x SC Duplex/SC Duplex, Singlemode; With 12 adapters	1418731-1	1418733-1
12 x SC Duplex/SC Duplex, Singlemode; With 6 adapters	1418730-1	1418732-1
24 x ST Style; Unpopulated	969614-1	969993-1
24 x ST Style Multimode; With 24 adapters	1-969618-1	969630-1
24 x ST Style Multimode; With 12 adapters	1-969616-1	969628-1

1U MT-RJ patch panel, international version

FEATURES

- MT-RJ panel, 1U, 19"
- Holds up to 24 MT-RJ Jacks or up to 24 MT-RJ pigtails
- Drawer style, slide and tilt
- Incl. management rings
- Splice tray not included

Color: black (RAL 9005)



ORDERING INFORMATION

Description	Part Number
24 positions for MT-RJ jacks accepts: MT-RJ panel jack or MT-RJ pigtails with 6 cable entries, incl. 2 metric glands	1206704-4

Fiber Optic Cabling

Patch Panels

Fiber Optic 1U Plastic Fiber Patch Panel

FEATURES

- 1U sliding panel for ease of access and standard deployment into 19 inch racks
- Internal cable management protects splices and pigtails and maintains bend radius
- A PC-ABS construction means that the tray is both lightweight whilst retaining mechanical strength
- UL94V -0 flammability rating, allows usage within a building



ORDERING INFORMATION

Description	Color	Adaptor	Fiber type	Part Number
Fiber patch panel 12 port	grey	6 x SC Duplex	multimode	7033 1 080-12
Fiber patch panel 24 port	grey	12 x SC Duplex	multimode	7033 1 080-24
Fiber Patch Panel 12 Port	black	6 x SC Duplex	multimode	7033 1 180-12
Fiber Patch Panel 24 Port	black	12 x SC duplex	multimode	7033 1 180-24
Fiber Patch Panel 12 Port	grey	12 x ST	multimode	7033 1 082-12
Fiber Patch Panel 24 Port	grey	24 x ST	multimode	7033 1 082-24
Fiber Patch Panel 12 Port	black	12 x ST	multimode	7033 1 182-12
Fiber Patch Panel 24 Port	black	24 x ST	multimode	7033 1 182-24
Fiber patch panel 24 port	grey	12x LC Duplex	multimode	7033 1 103-12
Fiber patch panel 48 port	grey	24 x LC Duplex	multimode	7033 1 103-24
Fiber patch panel 12 port	grey	6 x SC Duplex	singlemode	7033 1 101-12
Fiber patch panel 24 port	grey	12 x SC Duplex	singlemode	7033 1 101-24
Fiber patch panel 24 port	grey	12 x LC Duplex	singlemode	7033 1 084-12
Fiber patch panel 48 port	grey	24 x LC Duplex	singlemode	7033 1 084-24

Fiber Optic Cabling

Accessories for Patch Panels

Accessories for Patch Panels, 1U Modular Fiber Optic Panel Flushmount Style

ORDERING INFORMATION

Description	Part Number
Cable management kit with glands; Packaging: 1; For 1U - Modular Fiber Optic Panel - Flushmount style	1671273-1
Cable termination kit with flex tube; Packaging: 1; For 1U - Modular Fiber Optic Panel - Flushmount style	1671274-1



Accessories for Patch Panels, German Version

ORDERING INFORMATION

Description	Part Number
45° cable entry plate for metric glands (german style panels only); Packing: 1	1418770-1



Fiber Optic Cabling

Patch Panels

Accessories for all Patch Panels

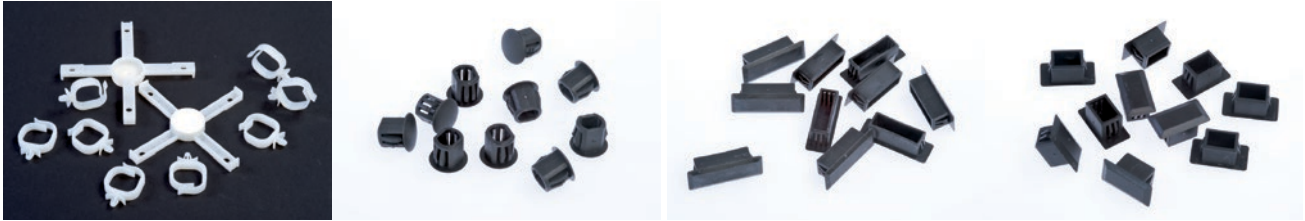

ORDERING INFORMATION

Description	Part Number
Dust cover for SC Duplex Cut-Out; Packaging: 100	1206121-2
Dust cover for ST-Style Cut-Out; Packaging: 100	1206134-1
PG 9 Gland (3.5-8 mm); Packaging: 50	1206144-1
PG 16 Gland (9-14 mm); Packaging: 50	1206145-1
Cable management ring kit (2 rings); Packaging: 1	1206146-1
Dust cover for SC Simplex/LC Simplex Cut-Out; Packaging: 100	1418800-1
M 20; Packaging: 50	1671054-1
M 25; Packaging: 50	1671054-2

Fiber Optic Cabling

Quick-Fit Modules

Quick-Fit Fiber Modules

FEATURES

- Universal Modules with Quick-Fit footprint
- Fit in all TE CONNECTIVITY Patch Panels with Quick-Fit footprint
- Not interchangeable with push pin fixation

Color: black (RAL 9005)

Note: MT-RJ panel jacks NOT include



ORDERING INFORMATION

Description	Color	Part Number
6 x LC duplex; Fiber Type: OM2; Ferrule: Ceramic	Black	1671196-2
6 x LC duplex; Fiber Type: OM3 XG 10 Gb/s; Ferrule: Ceramic	Aqua	1671196-3
6 x LC duplex; Fiber Type: OS2; Ferrule: Ceramic	Blue	1671196-1
6 x LC/APC duplex; Fiber Type: OS2; Ferrule: Ceramic	Green	1671196-4
6 x LC quad; Fiber Type: OM2; Ferrule: Composite	Beige	1671202-2
6 x LC quad; Fiber Type: OM3 XG 10 Gb/s; Ferrule: Ceramic	Aqua	1671202-3
6 x LC quad; Fiber Type: OS2; Ferrule: Ceramic	Blue	1671202-1
6 x LC/APC quad; Fiber Type: OS2; Ferrule: Ceramic	Green	1671202-4
6 x MT-RJ*; Fiber Type: OM2; Ferrule: Composite	Black	1671197-2
6 x MT-RJ*; Fiber Type: OM3 XG 10 Gb/s; Ferrule: Ceramic	Aqua	1671197-3
6 x MT-RJ*; Fiber Type: OS2; Ferrule: Ceramic	Blue	1671197-1
6 x SC duplex; Fiber Type: OM2; Ferrule: Ceramic	Beige	1671201-2
6 x SC duplex; Fiber Type: OM3 XG 10 Gb/s; Ferrule: Ceramic	Aqua	1671201-3
6 x SC duplex; Fiber Type: OS2; Ferrule: Ceramic	Blue	1671201-1
6x SC/APC duplex; Fiber Type: OS2; Ferrule: Ceramic	Green	1671201-4
6 x ST; Fiber Type: Multimode; metallic body; Ferrule: Composite		1671195-2
6 x ST; Fiber Type: Singlemode; metallic body; Ferrule: Ceramic		1671195-1
Blank module		1479698-1

MPO/MPOptimate coupler Quick-Fit module

FEATURES

- Quick-Fit module with 6 x MPO coupler
- Port number labeling and additional label strip included
- MPO coupler always used with on one side MPO male and other side MPO female connector

Color: black (RAL 9005)

ORDERING INFORMATION

Description	Part Number
6 x MPO coupler module	1671200-1
12 x MPO coupler module	1711987-1



Fiber Optic Cabling

Wall Mount Enclosures

Wall Mount Enclosure for 6 Modules, Unloaded, with Side Door

FEATURES

- Accepts 6 Snap-In-Modules (Snap-In Modules)
- Optional lock available (559501-2)
- Optional grommets available
- Splice tray holder available
- Designed for intrabuilding or campus backbone applications
- Reversible cable strain relief bracket
- Recessed, easy-to-use door latches
- Dimensions (for exact dimensions consult customer drawing):
16.5" (40 cm) H x 14" (35.5 cm) D x 5" (13 cm) W

Color: black (RAL 9005)



ORDERING INFORMATION

Description	Part Number
With grommets, cable glands and splice tray holder	1278755-4
Splice tray holder kit	1374526-1
Grommets	559496-2
Lock	559501-2

Wall Mount Enclosure 2F/4F (Plastic)

FEATURES

- Pre-installed adapter
- Size: 125 x 150 x 65 mm (W x H x D)
- IP 53 rated

ORDERING INFORMATION

Description	Part Number
Wall Mount Enclosure 2F, 1 x SC Duplex, MM	1671116-1
Wall Mount Enclosure 2F, 1 x SC Duplex, SM	1671116-2
Wall mount enclosure 4F, 1 x LC quad, MM	1671116-3
Wall mount enclosure 4F, 1 x LC quad, SM	1671116-4



Fiber Optic Cabling

Wall Mount Enclosures

Wall Mount Enclosure 6F/12F (Plastic)

FEATURES

- Pre-installed adapters
- Incl. management ring
- Size: 225 x 280 x 85 mm (W x H x D)
- IP 53 rated

ORDERING INFORMATION

Description	Part Number
Wall Mount Enclosure 6F, 1 x SC Duplex, MM	1671117-1
Wall Mount Enclosure 6F, 1 x SC Duplex, SM	1671117-2
Wall Mount Enclosure 12F, 3 x LC quad, MM	1671117-3
Wall Mount Enclosure 12F, 3 x LC quad, SM	1671117-4



Fiber Optic Cabling

Snap-In Modules

MPO/MPOptimate Snap-In module

FEATURES

- Fits in all TE CONNECTIVITY patch panels for Snap-In modules

Color: black (RAL 9005)



ORDERING INFORMATION

Description	Part Number
MPO coupler 6 x 12 fibers (multimode + singlemode); Packaging: 1	1374598-1

LC Snap-In-Modules

FEATURES

- Fits in all TE CONNECTIVITY patch panels for Snap-In modules

ORDERING INFORMATION

Description	Part Number
LC Duplex, 12 fibers (Singlemode), Packaging: 1	1374463-1
LC Duplex, 12 fibers (Multimode), Packaging: 1	1374463-2



SC Snap-In-Modules

FEATURES

- Fits in all TE CONNECTIVITY Patch Panels for Snap-In-Modules

ORDERING INFORMATION

Description	Part Number
Duplex SC, 6 fibers; Packaging: 1; Fiber type: Multimode	559558-1
Duplex SC, 6 fibers; Packaging: 1; Fiber type: Singlemode	559558-2
Duplex SC, 12 fibers; Packaging: 1; Fiber type: Multimode	559596-1
Duplex SC, 12 fibers; Packaging: 1; Fiber type: Singlemode	559596-2

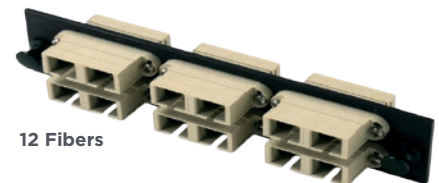

SC to ST-Style Snap-In-Modules

FEATURES

- Fits in all TE CONNECTIVITY Patch Panels for Snap-In-Modules

ORDERING INFORMATION

Description	Part Number
Duplex SC to ST-Style, 12 fibers (Multimode), Packaging: 1	1278368-1
Duplex SC to ST-Style, 6 fibers (Multimode), Packaging: 1	559601-1

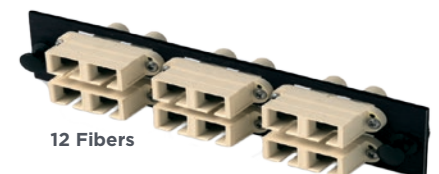

Fiber Optic Cabling

Snap-In Modules

ST-Style Snap-In-Modules

ORDERING INFORMATION

Description	Part Number
ST-Style, 12 fibers (Multimode); Packaging: 1	1278567-1
ST-Style, 12 fibers (Singlemode); Packaging: 1	1278567-2
ST-Style, 6 fibers (Singlemode); Packaging: 1	559515-2
ST-Style, 6 fibers (Multimode); Packaging: 1	559557-1



12 Fibers



6 Fibers

MT-RJ Snap-In-Modules

FEATURES

- Holds up to six MT-RJ Jacks or MT-RJ Jack pigtails
- Individual ports icon-able

ORDERING INFORMATION

Description	Part Number
Snap-In-Module for 6 MT-RJ Jacks or Jack Pigtails	1278328-3



Snap-In-Modules for Micro-Cassettes

FEATURES

- Holds up to two Micro-Cassettes (see page 3)

ORDERING INFORMATION

Description	Part Number
Snap-In-Modules, for up to 2 Micro-Cassettes (box of 6 modules + 6 blanking plates)	2153245-1
Snap-In-Modules, for up to 2 Micro-Cassettes (box of 48 modules + 48 blanking plates)	2153245-2



Part Number

Snap-In-Modules for SL Jacks

FEATURES

- Holds up to six jacks/couplers with SL footprint

ORDERING INFORMATION

Description	Part Number
6 port SL, black	1479506-1
6 port SL, not painted	1671168-1

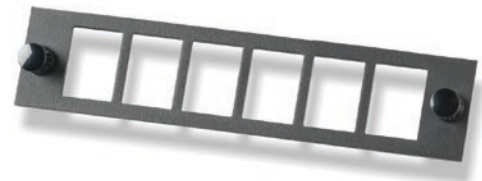

Snap-In blank modules

ORDERING INFORMATION

Description	Part Number
Blank module for panel ≥2 U and wall mount box; Packaging: 1	559523-1
Blank module, Packaging: 1	1671146-1



Fiber Optic Cabling

Pre-assembled LC & SC Trunks

Multi fiber pre-assembled trunk cables

FEATURES:

- Factory pre-assembled 6 or 12 fiber trunks
- Simplex connectors at each end (LC/LC, SC/SC or LC/SC)
- LSZH cable loose tube indoor/outdoor cable
- Staggered tails provide easy cable management
- Tail lengths: 4x40+4x50+4x60 (6x50 for 6 fiber cables)
- Other cable constructions/configurations available on request
- The trunks are equipped with midi fan-out and 2mm round tails protected with transparent protection sleeve
- All cords with protocol, for constant and reliable quality
- Packaging: ≤50 m in box, >50 m on reel
- Re-usable pulling socks can be ordered separately (Part Number 2055567-1, see page 21)



ORDERING INFORMATION

		Fiber type	Part Number	Part Number
			2-99 m table A*	100-500m table B*
12 fiber assembly	SC/SC	OM3	Y-2055665-X	Y-2055666-X
	SC/SC	OM4	Y-2055613-X	Y-2055614-X
	SC/SC	SM	Y-2055687-X	Y-2055688-X
	LC/LC	OM3	Y-2055725-X	Y-2055726-X
	LC/LC	OM4	Y-2055583-X	Y-2055584-X
	LC/LC	SM	Y-2055727-X	Y-2055728-X
	LC/SC	OM3	Y-2055667-X	Y-2055668-X
	LC/SC	SM	Y-2255669-X	Y-2055670-X
6 fiber assembly	LC/LC	OM3	Y-2160142-X	Y-2160143-X
	LC/LC	OM4	Y-2160144-X	Y-2160145-X
	LC/LC	SM	Y-2055740-X	Y-2055741-X

* For length tables A and B please refer to page 2 in the MPO/MPOptimate Chapter.

Fiber Optic Cabling

Patch Cords and Pigtails/Technical Data

Technical Data for Patch Cords & Pigtails

- All assemblies are machine polished providing highest quality.
- Multimode OM3, OM4 and singlemode OS2 assemblies have an ensured performance by Optimized-Physical-Contact (OPC).
- All assemblies are factory tested and come with a test protocol.
- Attenuation and Return Loss values specified against reference connectors.



For all OM4 assemblies



For all OM3, OM4 & OS2 assemblies

PATCH CORDS

Fiber Cable		Connector Ferrule Material		
Cable sheath material	LSZH		LC, SC, ST	ceramic
LC	mini twinzip 1.8mm		MT-RJ, MPO	thermoplastic
SC, ST	twinzip 2.5mm			
LC duplex uniboot	dualan round 2mm			
MT-RJ	mini twinzip 1.8mm			

MULTIMODE	FIBER TYPE	MAX. ATTENUATION [dB]*	MIN. RETURN LOSS [dB]*	TEMP RANGE
LC/PC & SC/PC & ST/PC	OM1, OM2	0.3	20	-10°C / +60°C
LC/PC & SC/PC	OM3	0.3	25	-10°C / +60°C
LC/PC & SC/PC (LOW LOSS)	OM3, OM4	0.15	35	-10°C / +60°C
MT-RJ	OM1, OM2	0.5	20	-10°C / +60°C
MT-RJ	OM3	0.5	25	-10°C / +60°C
MPO	OM1, OM2	0.75	20	-10°C / +60°C
MPO	OM3	0.5	25	-10°C / +60°C
MPOptimate	OM3, OM4	0.35	28	-10°C / +60°C

SINGLEMODE

LC/PC & SC/PC & ST/PC	OS2	0.3	45	-10°C / +60°C
LC/APC & SC/APC	OS2	0.3	65	-10°C / +60°C
MT-RJ	OS2	0.75	35	-10°C / +60°C
MPO, MPO/APC	OS2	0.6	35	-10°C / +60°C

* Attenuation and return loss values against reference connector

PIGTAILS

Fiber Cable	Connector Ferrule Material		
Tight buffer or semi-tight	LC, SC, ST		ceramic
(specified per part number)	MT-RJ		thermoplastic

MULTIMODE	FIBER TYPE	MAX. ATTENUATION [dB]*	MIN. RETURN LOSS [dB]*	TEMP RANGE
LC/PC & SC/PC & ST/PC	OM1, OM2	0.3	20	-10°C / +60°C
LC/PC & SC/PC	OM3	0.3	25	-10°C / +60°C
LC/PC & SC/PC (LOW LOSS)	OM3, OM4	0.15	35	-10°C / +60°C
MT-RJ	OM1, OM2	0.5	20	-10°C / +60°C
MT-RJ	OM3	0.5	25	-10°C / +60°C

SINGLEMODE

LC/PC & SC/PC & ST/PC	OS2	0.3	45	-10°C / +60°C
LC/APC & SC/APC	OS2	0.3	65	-10°C / +60°C
MT-RJ	OS2	0.75	35	-10°C / +60°C

* Attenuation and return loss values against reference connector

Fiber Optic Cabling

Patch Cords and Pigtails

LC Duplex Uniboot - LC Duplex Uniboot

FEATURES

- All assemblies are machine polished providing the highest quality
- Multimode OM3, OM4 and singlemode assemblies have an ensured performance by Optimized-Physical-Contact (OPC)
- All assemblies are factory tested and come with a test protocol



ORDERING INFORMATION

Description	Part Number
OM2	Y-2160404-X
OM3	Y-2160349-X
OM4	Y-2160588-X

Y- -X	Length
0- -1	1 m
0- -2	2 m
0- -3	3 m
0- -5	5 m
1- -0	10 m

LC Duplex / LC Duplex Patch Cords

FEATURES

- All assemblies are machine polished providing highest quality.
- Multimode OM3, OM4 and singlemode OS2 assemblies have an ensured performance by Optimized-Physical-Contact (OPC).
- All assemblies are factory tested and come with a test protocol.

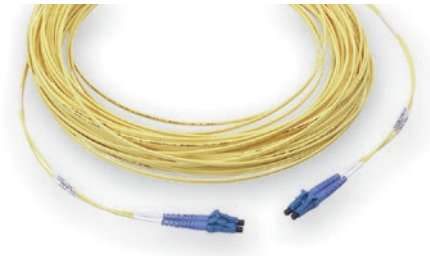

ORDERING INFORMATION

Description	Part Number
OS2	Y-6536501-X
OS2/APC	Y-2160008-X
OM2	Y-6536502-X
OM1	Y-6536503-X
OM3 XG 10 Gb/s	Y-6536969-X
OM4	Y-2160046-X

Y- -X	Length
0- -1	1 m
0- -2	2 m
0- -3	3 m
0- -5	5 m
1- -0	10 m

Fiber Optic Cabling

Patch Cords and Pigtails

LC Duplex / SC Duplex Patch Cords

FEATURES

- All assemblies are machine polished providing highest quality.
- Multimode OM3, OM4 and singlemode OS2 assemblies have an ensured performance by Optimized-Physical-Contact (OPC).
- All assemblies are factory tested and come with a test protocol.



ORDERING INFORMATION

Description	Part Number	Y- -X	Length
OS2	Y-6536508-X	0- -1	1 m
OM2	Y-6536509-X	0- -2	2 m
OM1	Y-6536510-X	0- -3	3 m
OM3 XG 10 Gb/s	Y-6536967-X	0- -5	5 m
OM4	Y-2160048-X	1- -0	10 m

LC Duplex / ST-Style Patch Cords

FEATURES

- All assemblies are machine polished providing highest quality.
- Multimode OM3 and singlemode OS2 assemblies have an ensured performance by Optimized-Physical-Contact (OPC).
- All assemblies are factory tested and come with a test protocol.



ORDERING INFORMATION

Description	Part Number	Y- -X	Length
OS2	Y-6695657-X	0- -1	1 m
OM2	Y-1568757-X	0- -2	2 m
OM1	Y-6695121-X	0- -3	3 m
OM3 XG 10 Gb/s	Y-6695697-X	0- -5	5 m
		1- -0	10 m

Fiber Optic Cabling

Patch Cords and Pigtails

SC Duplex / SC Duplex Patch Cords

FEATURES

- All assemblies are machine polished providing highest quality.
- Multimode OM3, OM4 and singlemode OS2 assemblies have an ensured performance by Optimized-Physical-Contact (OPC).
- All assemblies are factory tested and come with a test protocol.



ORDERING INFORMATION

Description	Part Number	Y- -X	Length
OS2	Y-6348260-X	0- -1	1 m
OS2/APC	Y-6536767-X	0- -2	2 m
OM2	Y-5349565-X	0- -3	3 m
OM1	Y-5349578-X	0- -5	5 m
OM3 XG 10 Gb/s	Y-6536464-X	1- -0	10 m
OM4	Y-2160047-X		

SC Duplex / ST-Style Duplex Patch Cords

FEATURES

- All assemblies are machine polished providing highest quality.
- All assemblies are factory tested and come with a test protocol.

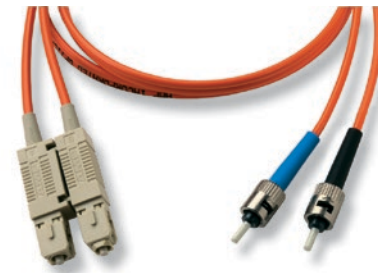

ORDERING INFORMATION

Description	Part Number	Y- -X	Length
OM2	Y-5349567-X	0- -1	1 m
OM1	Y-5349580-X	0- -2	2 m
		0- -3	3 m
		0- -5	5 m
		1- -0	10 m

ST-Style Duplex / ST-Style Duplex Patch Cords

FEATURES

- All assemblies are machine polished providing highest quality.
- Singlemode OS2 assemblies have an ensured performance by Optimized-Physical-Contact (OPC).
- All assemblies are factory tested and come with a test protocol.



ORDERING INFORMATION

Description	Part Number	Y- -X	Length
OS2	Y-6206158-X	0- -1	1 m
OM2	Y-5349561-X	0- -2	2 m
OM1	Y-5349574-X	0- -3	3 m
		0- -5	5 m
		1- -0	10 m

Fiber Optic Cabling

Patch Cords and Pigtails

MT-RJ/MT-RJ Patch Cords

FEATURES

- All assemblies are machine polished providing highest quality.
- Multimode OM3 and singlemode OS2 assemblies have an ensured performance by Optimized-Physical-Contact (OPC).
- All assemblies are factory tested and come with a test protocol.



ORDERING INFORMATION

Description	Part Number	Y- -X	Length
OS2	Y-6206621-X	0- -1	1 m
OM2	Y-6206617-X	0- -2	2 m
OM1	Y-6206613-X	0- -5	5 m
OM3 XG 10 Gb/s	Y-6536462-X	1- -0	10 m

MT-RJ/LC Duplex Patch Cords

FEATURES

- All assemblies are machine polished providing highest quality.
- Multimode OM3 and singlemode OS2 assemblies have an ensured performance by Optimized-Physical-Contact (OPC).
- All assemblies are factory tested and come with a test protocol.



ORDERING INFORMATION

Description	Part Number	Y- -X	Length
OS2	Y-6536511-X	0- -1	1 m
OM2	Y-6536512-X	0- -2	2 m
OM1	Y-6536513-X	0- -3	3 m
OM3 XG 10 Gb/s	Y-6536968-X	0- -5	5 m
		1- -0	10 m

MT-RJ/SC Duplex Patch Cords

FEATURES

- All assemblies are machine polished providing highest quality.
- Multimode OM3 and singlemode OS2 assemblies have an ensured performance by Optimized-Physical-Contact (OPC).
- All assemblies are factory tested and come with a test protocol.

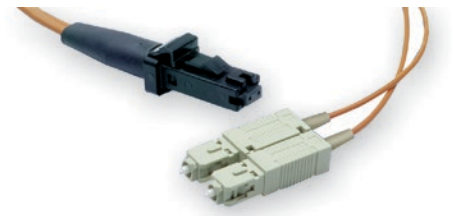

ORDERING INFORMATION

Description	Part Number	Y- -X	Length
OS2	Y-6206623-X	0- -1	1 m
OM2	Y-6206619-X	0- -2	2 m
OM1	Y-6206615-X	0- -3	3 m
OM3 XG 10 Gb/s	Y-6536463-X	0- -5	5 m
		1- -0	10 m

Fiber Optic Cabling

Patch Cords and Pigtails

MT-RJ/ST-Style Duplex Patch Cords

FEATURES

- All assemblies are machine polished providing highest quality.
- Multimode OM3 and singlemode OS2 assemblies have an ensured performance by Optimized-Physical-Contact (OPC).
- All assemblies are factory tested and come with a test protocol.

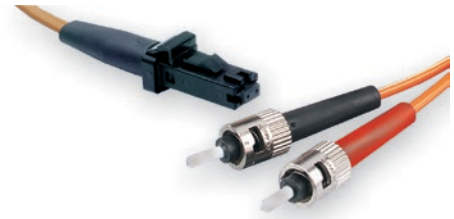

Y- -X	Length
0- -1	1 m
0- -2	2 m
0- -3	3 m
0- -5	5 m
1- -0	10 m

ORDERING INFORMATION

Description	Part Number
OM2	Y-6206620-X
OM1	Y-6206616-X

Mode Conditioning Patch Cords

FEATURES

- Used for the implementation of Gigabit and 10 Gigabit Ethernet laser based transmissions over multimode fiber (MMF)
- For 50 µm and 62,5 µm fibers
- LSZH sheath
- Standard length 3 m

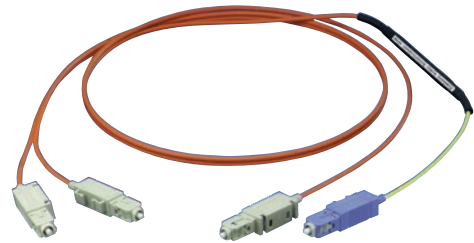

ORDERING INFORMATION

Description	Part Number
LC Duplex (SM) to LC Duplex, OM2; Length: 3 m	6536803-3
LC Duplex (SM) to SC Duplex, OM2; Length: 3 m	6536810-3
LC Duplex (SM) to SC Duplex, OM1; Length: 3 m	6536811-3
LC Duplex (SM) to ST-Style Duplex, OM1; Length: 3 m	6695313-3
SC Duplex to SC Duplex;OM2; Length: 3 m	6206820-3
SC Duplex to SC Duplex; OM2; Length: 3 m	6206821-3
SC Duplex (SM) to ST-Style Duplex; OM2; Length: 3 m	6348269-3
SC Duplex to ST-Style Duplex; OM1; Length: 3 m	6348271-3
SC Duplex (SM) to MT-RJ; OM2; Length: 3 m	6536769-3
SC Duplex (SM) to MT-RJ; OM1; Length: 3 m	6536770-3
MT-RJ (SM) to SC Duplex; OM2; Length: 3 m	6536447-3
MT-RJ (SM) to SC Duplex; OM; Length: 3 m	6536446-3
MT-RJ (SM) to ST-Style Duplex; OM2; Length: 3 m	6536445-3
MT-RJ (SM) to ST-Style Duplex; OM1; Length: 3 m	6536444-3

Fiber Optic Cabling

Patch Cords and Pigtails

LC Pigtails

FEATURES

- All assemblies are machine polished providing highest quality.
- Multimode OM3, OM4 and singlemode OS2 assemblies have an ensured performance by Optimized-Physical-Contact (OPC).
- All assemblies are factory tested and come with a test protocol.

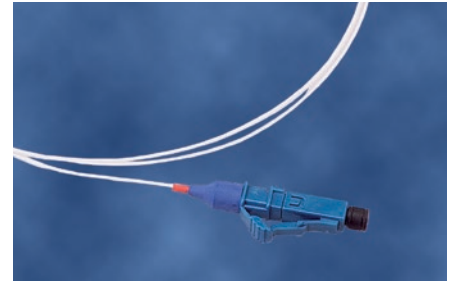

ORDERING INFORMATION

Description	Part Number
LC tuned; OS2; Strip: semi-tight; Length: 2 m	6536880-2
LC tuned; OS2; Strip: tight; Length: 2 m	6695512-2
LC/APC; OS2; Strip: semi-tight; Length: 2 m	2055425-2
LC; OM1; Strip: semi-tight; Length: 2 m	6536974-2
LC; OM1; Strip: tight; Length: 2 m	6695510-2
LC; OM2; Strip: semi-tight; Length: 2 m	6536975-2
LC; OM2; Strip: tight; Length: 2 m	6695509-2
LC; OM3 XG 10 Gb/s; Strip: semi-tight; Length: 2 m	6536966-2
LC; OM3 XG 10 Gb/s; Strip: tight; Length: 2 m	6695511-2
LC; OM4; Strip: semi-tight buffer; Length: 2 m	2160042-2
LC; OM4; Strip: tight buffer; Length: 2 m	2160040-2

SC Pigtails

FEATURES

- All assemblies are machine polished providing highest quality.
- Multimode OM3, OM4 and singlemode OS2 assemblies have an ensured performance by Optimized-Physical-Contact (OPC).
- All assemblies are factory tested and come with a test protocol.

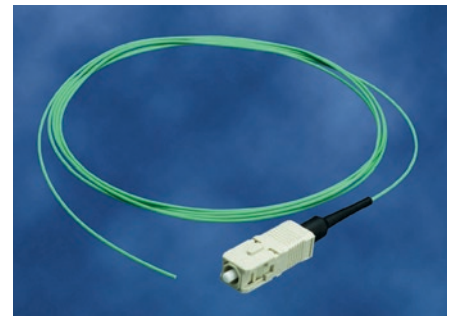

ORDERING INFORMATION

Description	Part Number
SC/PC tuned; OS2; Strip: semi-tight; Length: 2 m	5233582-2
SC/PC tuned; OS2; Strip: tight; Length: 2 m	6695508-2
SC/APC; OS2; Strip: semi-tight; Length: 2 m	5233103-2
SC; OM1; Strip: semi-tight; Length: 2 m	5349584-4
SC; OM1; Strip: tight buffer; Length: 2 m	6695506-2
SC; OM2; Strip: semi-tight; Length: 2 m	5349568-4
SC; OM2; Strip: tight buffer; Length: 2 m	6695505-2
SC OM3 XG 10 Gb/s (Strip length ca. 0.8 m); Strip: semi-tight; Length: 2 m	6536555-2
SC OM3 XG 10 Gb/s; Strip: tight; Length: 2 m	6695507-2
SC; OM4; Strip: semi-tight buffer; Length: 2 m	2160043-2
SC; OM4; Strip: tight buffer; Length: 2 m	2160041-2

Fiber Optic Cabling

Patch Cords and Pigtails

ST-Style Pigtails

FEATURES

- All assemblies are machine polished providing highest quality.
- All assemblies are factory tested and come with a test protocol.

ORDERING INFORMATION

Description	Part Number
ST-Style; OM2; Length: 2 m	5349569-4
ST-Style; OM1; Length: 2 m	5349582-4



MT-RJ Pigtails

FEATURES

- Fits in all TE CONNECTIVITY MT-RJ Patch Panels
- Multimode OM3 and singlemode OS2 assemblies have an ensured performance by Optimized-Physical-Contact (OPC).
- Colored housing optional available

ORDERING INFORMATION

Description	Part Number
MT-RJ SL Series Housing; Color: almond	1374416-1
MT-RJ SL Series Housing; Color: black	1374416-2
MT-RJ SL Series Housing; Color: white	1374416-3
MT-RJ SL Series Housing; Color: grey	1374416-4
MT-RJ SL Series Housing; Color: electrical ivory	1-1374416-1
MT-RJ Jack Pigtail; OM1; Color: black; Length: 3 m;	6348941-1
MT-RJ Jack Pigtail; OM2; Color: black; Length: 3 m;	6348942-1
MT-RJ Jack Pigtail; OS2; Color: blue; Length: 3 m;	6391366-1
MT-RJ Jack Pigtail; OM3 10Gbit XG; Color: black; Length: 3 m;	6536556-1

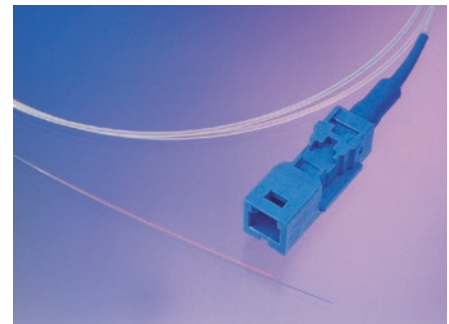

Fiber Optic Cabling

Outlets

Universal Fiber Optic wall outlets

FEATURES

- Unpopulated wall outlets for all Fiber-to-the-Desk applications (Inserts to be ordered separately)

Color: pure white (RAL 9010)



ORDERING INFORMATION

Description	Part Number
"45x45" Outlet 45 x 45 mm for SC-Duplex, ST-Style, SL adaptor or MT-RJ jack; Color: white (RAL 9010)	183931-1
DIN Outlet for SC Duplex or SC/ST-Style Duplex Adaptor; Frame: No; Color: almond (RAL 1013)	966936-2
DIN Outlet for SC Duplex or SC/ST-Style Duplex Adaptor; Frame: No; Color: white (RAL 9010)	2-966936-2

DIN Dual Angled Outlet

FEATURES

- Dual outlet to accept either up to 2 SL Series Jacks
- To be used with single or multiple gang DIN faceplates
- Supplied complete with back plate, adapter plate and shutters
- Individual ports are icon-able



ORDERING INFORMATION

Description	Part Number
DIN Dual Angled Outlet, for 2x Slim Line Jack; Color: almond (RAL 1013)	966936-5
DIN Dual Angled Outlet, for 2x Slim Line Jack; Color: pure white (RAL 9010)	2-966936-5

Fiber Optic Cabling

Outlets

DIN Surface Mount Outlet Back Box

FEATURES

- Back Box for Surface Mounting
- Available individually or as a complete kit with a single faceplate
- Not suitable for use with multiple faceplates

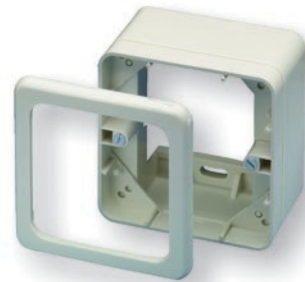

ORDERING INFORMATION

Description	Part Number
Surface Mount Outlet Back Box; almond (RAL 1013); Back box only	966740-1
Surface Mount Outlet Back Box; almond (RAL 1013); Back box + faceplate	966740-2
Surface Mount Outlet Back Box; pure white (RAL 9010); Back box only	2-966740-1
Surface Mount Outlet Back Box; pure white (RAL 9010); Back box + faceplate	2-966740-2
Adaptor DIN RAIL to DIN Surface Mount Outlet Back Box	1671164-1

Cable Management for 2 Port Wall Outlets

FEATURES

- Cable management with strain relief for the cable
- For all DIN style wall outlets

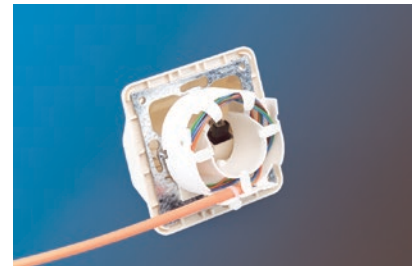

ORDERING INFORMATION

Description	Part Number
Cable management	1534332-1

Fiber Optic Cabling

Outlets

Fiber Optic Wall Outlet

FEATURES

- Designed for modern small-form-factor deployments and into legacy Gigabit Ethernet deployments.
- MT-RJ offers both singlemode and multimode solutions, whilst LC, SC, and ST are available as a multimode solution.
- Integrated cable management allows diverse routing for excess spool management and maintenance of bend radius whilst the Fiber optic cable is housed in the solution.
- The footprint suits standard (BS4660) electrical wall back boxes for deployment in trunking and walls.
- Designed to allow the insertion of heat shrink splice protection holders giving the flexibility to choose between direct termination and splicing.
- Anchor points allow the Fiber optic cable to be tied-off at the point of entry into the base which prevents the cable from slipping back into a wall recess during installation.
- Per port labelling provides easy identification of each subscriber network link.



ORDERING INFORMATION

Description	Part Number
1 x SC duplex outlet	7033106902
2 x SC duplex outlet	7033106904
2 x ST outlet	7033107102
4 x ST outlet	7033107104
1 x LC quad outlet	1350376
2 x LC quad outlet	1350377

Fiber Optic Cabling

Adaptors

LC Duplex/LC Duplex Adaptors

FEATURES

- Suitable for any LC Duplex connector
- Fits in any SC Simplex cut-out
- Available for singlemode and multimode



ORDERING INFORMATION

Description	Part Number
Housing: Plastic; Sleeve: Ceramic; Color: blue; Mounting: Clip/Screw; Application: SM	6457567-4
Housing: Plastic; Sleeve: Ceramic; Color: almond; Mounting: Clip/Screw; Application MM	6457567-5
Housing: Plastic; Sleeve: Ceramic; Color: green; Mounting: Clip/Screw; Application: SM	2125019-2
Housing: Plastic; Sleeve: Metal; Color: almond; Mounting: Clip/Screw; Application: MM	6457567-8
Housing: Plastic; Sleeve: Ceramic; Color: aqua; Mounting: Clip/Screw; Application: OM3 XG 10Gb/s	1-6457567-6

LC Quad/LC Quad Adaptors

FEATURES

- Suitable for any LC Duplex connector
- Fits in any SC Duplex cut-out
- Available for singlemode and multimode



ORDERING INFORMATION

Description	Part Number
Housing: Plastic; Sleeve: Ceramic; Color: blue; Mounting: Clip/Screw; Application: SM	1695790-4
Housing: Plastic; Sleeve: Metal; Color: beige; Mounting: Clip/Screw; Application: MM	1695790-5
Housing: Plastic; Sleeve: Ceramic; Color: aqua; Mounting: Clip/Screw; Application: OM3 XG 10Gb/s	1-1695790-0
Housing: Plastic; Sleeve: Ceramic; Color: green; Mounting: Clip/Screw; Application : SM	1695790-6

SC Duplex/SC Duplex Adaptors

FEATURES

- Suitable for any SC duplex connector
- Available for singlemode and multimode



ORDERING INFORMATION

Description	Part Number
Housing: Plastic; Sleeve: Ceramic; Color: blue; Mounting: Clip/Screw; Application: SM	1-5502776-1
Housing: Plastic; Sleeve: Ceramic; Color: almond; Mounting: Clip/Screw; Application: MM	1-5502776-2
Housing: Plastic; Sleeve: Ceramic; aqua; Mounting: Clip/Screw; Application: OM3 XG 10 Gb/s	2-5502776-6
Housing: Plastic; Sleeve: Metal; Color: almond; Mounting: Clip/Screw; Application: MM	5504640-1
Housing: Plastic; Sleeve: Ceramic; Color: green; Mounting: Clip/Screw; Application SM	2-5502776-3
Housing: Plastic; Sleeve: Ceramic; Color: nickel; Mounting: Clip/Screw; Application: SM/MM	6278049-3

Fiber Optic Cabling

Adaptors

SC Simplex/SC Simplex Adaptors

FEATURES

- Suitable for any SC Simplex connector
- Available for singlemode and multimode

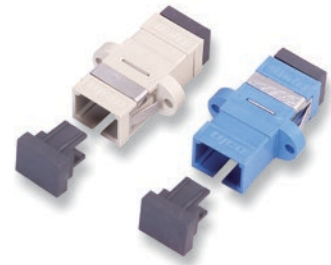

ORDERING INFORMATION

Description	Part Number
Housing: Plastic; Sleeve: Ceramic; Color: blue; Mounting: Clip/Screw; Application: SM	1-5502632-1
Housing: Plastic; Sleeve: Ceramic; Color: almond; Mounting: Clip/Screw; Application: MM	1-5502632-2
Housing: Plastic; Sleeve: Ceramic; Color: aqua; Mounting: Clip/Screw; Application: OM3 XG 10Gb/s	2-5502632-4
Housing: Plastic; Sleeve: Metal; Color: almond; Mounting: Clip/Screw; Application: MM	5504614-1

SC-APC/SC-APC Adaptors

FEATURES

- Suitable for any SC-APC connector



ORDERING INFORMATION

Description	Part Number
Simplex: Housing: Plastic; Sleeve: Ceramic; Color: green; Mounting: Clip/Screw; Application: SM	023826-000
Duplex: Housing: Plastic; Sleeve: Ceramic; Color: green; Mounting: Clip/Screw; Application: SM	2-5502776-3

ST-Style Simplex/ST-Style Simplex 2.5 mm Bayonet Adaptors

FEATURES

- Suitable for any ST-style simplex connector
- Available for singlemode and multimode



ORDERING INFORMATION

Description	Part Number
Housing: Metal; Sleeve: Polymer; Application: MM	501381-1
Housing: Metal; Sleeve: Ceramic; Application: SM	502750-1
Housing: Metal; Sleeve: Metal; Application: MM	504021-1
Housing: Metal; Sleeve: Metal; Application: MM	504021-2

Fiber Optic Cabling

Adaptors

SC Duplex/ST-Style Duplex Adaptors

FEATURES

- Available for singlemode and multimode
- Suitable for any ST-Style and SC connector



ORDERING INFORMATION

Description	Part Number
Housing: Plastic; Sleeve: Ceramic; Color: blue; Mounting: Clip/Screw; Application: SM; Packaging: 10	5503137-5
Housing: Plastic; Sleeve: Ceramic; Color: almond; Mounting: Clip/Screw; Application: MM Standard; Packaging: 10	5503137-6
Housing: Plastic; Sleeve: Metal; Color: almond; Mounting: Clip/Screw; Application: MM Standard; Packaging: 10	5504663-4

SC Simplex/ST-Style Simplex Adaptors

FEATURES

- Suitable for any ST and SC Simplex connector
- Available for singlemode and multimode

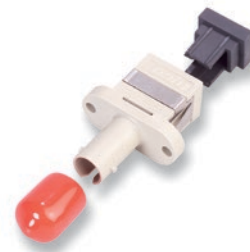

ORDERING INFORMATION

Description	Part Number
Housing: Plastic; Sleeve: Metal; Color: almond; Mounting: Clip/Screw; Application: MM;	5502780-3
Housing: Plastic; Sleeve: Ceramic; Color: blue; Mounting: Clip/Screw; Application: SM;	5502780-5
Housing: Plastic; Sleeve: Ceramic; Color: almond; Mounting: Clip/Screw; Application: MM	5502780-6

MT-RJ/MT-RJ Adaptors

FEATURES

- Suitable for MT-RJ connectors
(1 connector with guide pins, the other without pins)
- Simplex coupler fits in SC simplex cut-out
- Duplex coupler fits in SC duplex cut out
- Available for singlemode and multimode



ORDERING INFORMATION

Description	Part Number
Simplex; Housing: Plastic; Color: almond; Mounting: Clip/Screw; Application: MM/SM	1278017-1
Duplex; Housing: Plastic; Color: almond; Mounting: Clip/Screw; Application: MM	6374906-1
Duplex; Housing: Plastic; Color: blue; Mounting: Clip/Screw; Application: SM	6374906-5

Fiber Optic Cabling

LightCrimp and LightCrimp Plus

AMP LightCrimp Plus Connectors

FEATURES

- Easiest and quickest fiber termination (less than one minute)
- Factory polished for consistent high quality and finish (no paper required)
- No epoxy, curing or UV-light required
- Available for ST-Style, SC and LC
- Complies with the relevant TIA/EIA, IEC, CECC und EN/IS standards
- Durability: 500 cycles



TECHNICAL DATA

- Ferrule: Ceramic
 - Attenuation typical (dB): 0.3 (MM/SM)
 - Temperature range: -10°C to +60°C
- LightCrimp Plus ST-Style; English; Part Number: 408-4457

INSTRUCTION SHEET LIGHTCRIMP PLUS

LightCrimp Plus LC; English; Part Number: 408-8925
 LightCrimp Plus SC; English; Part Number: 408-4471

LightCrimp Plus LC Connectors

FEATURES

- LC connector (simplex or duplex)
- Ceramic ferrule
- With pre-installed and pre-polished fiber



ORDERING INFORMATION

Description	Part Number
Simplex LC OS2 (1.6 to 2.0 mm Jacketed Cable); Housing: Blue; Boot: Blue; Packaging: 10	1918626-1
Simplex LC OM1 (1.6 to 2.0 mm Jacketed Cable); Housing: Beige; Boot: Beige; Packaging: 10	1918627-1
Simplex LC OM2 (1.6 to 2.0 mm Jacketed Cable); Housing: Beige; Boot: Black; Packaging: 10	1918627-2
Simplex LC OM3 XG/OM4 XG _A (1.6 to 2.0 mm Jacketed Cable); Housing: Beige; Boot: Aqua; Packaging: 10	1918627-3
Simplex LC OS2 APC (250 μm + 900 μm only); Housing: green; Boot: blue; Packaging: 10	2064181-1
Simplex LC OS2 (250 μm + 900 μm only); Housing: blue; Boot: blue; Packaging: 10	6754482-1
Simplex LC OM1 (250 μm + 900 μm only); Housing: Beige; Boot: Beige; Packaging: 10	6754483-1
Simplex LC OM2 (250 μm + 900 μm only); Housing: Beige; Boot: black; Packaging: 10	6754483-2
Simplex LC OM3 XG/OM4 XG _A (250 μm + 900 μm only); Housing: Beige; Boot: Aqua; Packaging: 10	6754483-4
Clip to connect two LC simplex to one LC duplex connector; Black (6pc per bag)	1754371-2
Clip to connect two LC simplex to one LC duplex connector; Blue	1754371-4
Clip to connect two LC simplex to one LC duplex connector; Beige	1754371-5

Fiber Optic Cabling

LightCrimp and LightCrimp Plus

LightCrimp Plus SC Connectors

FEATURES

- SC connector (simplex)
- Ceramic ferrule
- With pre-installed and pre-polished fiber

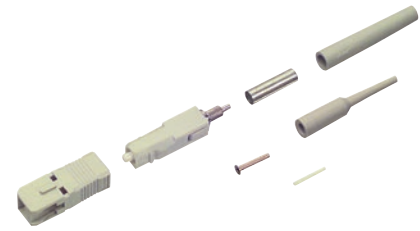

ORDERING INFORMATION

Description	Part Number
Simplex SC OS2 APC; (250 μm + 900 μm only); Body: green; Boot: Blue; Packaging: 10	2064184-1
Simplex SC OM1 (250 μm + 900 μm + 3 mm jacketed cable); Body: Beige; Boot: Beige; Packaging: 10;	5492643-1
Simplex SC OM2 (250 μm + 900 μm + 3 mm jacketed cable); Body: Beige; Boot: black; Packaging: 10;	6278079-2
Simplex SC OM3 XG/OM4 XG _A 10 Gb/s (250 μm + 900 μm + 3 mm jacketed cable); Body: Beige; Boot: Aqua; Packaging: 10;	6588291-2
Simplex SC OS2 (250 μm + 900 μm + 3 mm jacketed cable); Body: blue; Boot: blue; Packaging: 10	6693276-1
Clips to connect two SC simplex connectors to one SC duplex connector (2 clips needed); black	6348522-1
Clips to connect two SC simplex connectors to one SC duplex connector (2 clips needed); green	6348522-2
Clips to connect two SC simplex connectors to one SC duplex connector (2 clips needed); blue	6348522-3
Clips to connect two SC simplex connectors to one SC duplex connector (2 clips needed); beige	6348522-4



LightCrimp Plus ST-Style Connectors

FEATURES

- ST-Style Connectors
- Ceramic ferrule
- With pre-installed and pre-polished fiber



ORDERING INFORMATION

Description	Part Number
Simplex ST OS2 (250 μm + 900 μm + 3 mm jacketed cable); Boot: black; Packaging: 10	1828953-3
Simplex ST OM1 (250 μm + 900 μm + 3 mm jacketed cable); Boot: Beige; Packaging: 10	5492642-2
Simplex ST OM2 (250 μm + 900 μm + 3 mm jacketed cable); Boot: black; Packaging: 10	6278082-1
Simplex ST OM3 XG/OM4 XG _A (250 μm + 900 μm + 3 mm jacketed cable); Boot: Aqua; Packaging: 10	6278082-2



Fiber Optic Cabling

LightCrimp and LightCrimp Plus

LightCrimp Splice

FEATURES

- Terminates 250 micron coated and 900 micron tight buffered and 2.0 mm jacketed fibers
- Use with MM and SM 125 micron fibers
- Use with termination toolkit Part Number 1553212-1
- Typical attenuation 0.1 dB
- Typical return loss >20 dB MM and >35 dB SM
- Instruction sheets LightCrimp Splice: Part Number 408-10193



ORDERING INFORMATION

Description	Part Number
LightCrimp Splice for 250 micron coated and 900 micron tight buffered fibers	1985374-1
LightCrimp Splice for 2.0 mm jacketed fiber cable	1985805-1

AMP LightCrimp Connector

FEATURES

- Cleave, crimp, polish and connect
- High performance pre-radiussed ferrules
- Reduced polishing time
- Durability: 500 cycles
- Each connector comes in a kit containing accessories needed to terminate to 900 μm buffer, 250 μm coating and 3 mm cable
- Compliant with TIA/EIA, IEC, CECC and EN standards
- No epoxy - just polish



TECHNICAL DATA

- Ferrule: Ceramic or stainless steel
- Attenuation (dB): 0.3
- Temperature range: -40 °C (ceramic) or -25 °C (stainless steel) to +65 °C

INSTRUCTION SHEET LIGHTCRIMP

LightCrimp ST-Style; English: Part Number: 408-9860

LightCrimp SC; English; Part Number: 408-4066

Fiber Optic Cabling

LightCrimp and LightCrimp Plus

LightCrimp SC Connector

FEATURES

- SC connector (simplex or duplex)
- Ceramic ferrule
- With strain relief and crimp eyelet

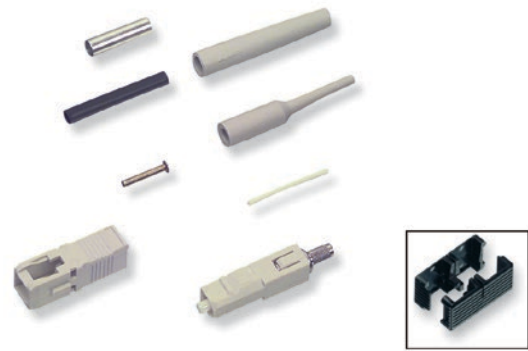

ORDERING INFORMATION

Description	Part Number
Simplex SC MM; Ferrule: Ceramic; Packaging: 10	5503692-1
Duplex SC MM; Ferrule: Ceramic; Packaging: 10	5503693-1
Clip to connect two SC simplex connectors to one SC duplex connector (2 clips needed); black	6348522-1
Clip to connect two SC simplex connectors to one SC duplex connector (2 clips needed); green	6348522-2
Clip to connect two SC simplex connectors to one SC duplex connector (2 clips needed); blue	6348522-3
Clip to connect two SC simplex connectors to one SC duplex connector (2 clips needed); beige	6348522-4

LightCrimp ST-Style Connector

FEATURES

- ST-Style connector
- Multimode and singlemode
- With strain relief and crimp eyelet



ORDERING INFORMATION

Description	Part Number
Singlemode ST-Style; Ferrule: Ceramic; Packaging: 1	5504000-1
Multimode ST-Style; Ferrule: Stainless steel; Packaging: 100	5504034-1
Multimode ST-Style; Ferrule: Ceramic; Packaging: 100	5504600-1

Fiber Optic Cabling

Epoxy Connectors

LC Connector Kits

FEATURES

- Multimode and singlemode (Telcordia GR-326 tested and TIA/EIA 568-B.3 qualified)
- Universal connector body:
 - common body for simplex or duplex
 - common body for jumper or buffer applications
- Field installable duplex clip
- Improved side load strength
- Attenuation typ. < 0.2 dB
- Temperature range -40 °C to +85 °C
- Durability: 0.2 dB change after 500 cycles (MM)

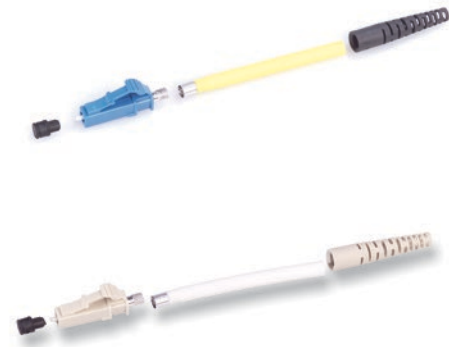

ORDERING INFORMATION

Description	Part Number
Type: Simplex; Ferrule: Ceramic; Boot: 1.6-2.0 mm; Fiber type: SM	1918266-1
Type: Simplex; Ferrule: Ceramic; Boot: 1.6-2.0 mm; Fiber type: MM	1918267-1
Type: Duplex; Ferrule: Ceramic; Boot: 1.6-2.0 mm; Fiber type: SM	1918372-1
Type: Duplex; Ferrule: Ceramic; Boot: 1.6-2.0 mm; Fiber type: MM	1918373-1
Type: Simplex; Ferrule: Ceramic; Boot: 3.0 mm; Fiber type: SM	1918374-1
Type: Simplex; Ferrule: Ceramic; Boot: 3.0 mm; Fiber type: MM	1918375-1
Type: Duplex; Ferrule: Ceramic; Boot: 3.0 mm; Fiber type: SM	1918376-1
Type: Duplex; Ferrule: Ceramic; Boot: 3.0 mm; Fiber type: MM	1918377-1
Type: Simplex; Ferrule: Ceramic; Boot: 0.9 mm; Fiber type: SM	1918384-1
Type: Simplex; Ferrule: Ceramic; Boot: 0.9 mm; Fiber type: MM	1918385-1
Type: Duplex; Ferrule: Ceramic; Boot: 0.9 mm; Fiber type: MM	1918388-1
Clip to connect two LC simplex to one LC duplex connector, Black	1754371-1
Clip to connect two LC simplex to one LC duplex connector, Black (6pc per bag)	1754371-2
Clip to connect two LC simplex to one LC duplex connector, Black (72 pc per bag)	1754371-3
Clip to connect two LC simplex to one LC duplex connector, Blue	1754371-4

Fiber Optic Cabling

Epoxy Connectors

SC Connector Kits

FEATURES

- High performance pre-radiussed ferrules
- SC compatible JIS C-5973
- Multimode or singlemode
- Durability: 0.2 dB change after 1000 cycles (MM)
- Temperature range: -40°C to +85°C
- Attenuation typ. < 0.2 dB
- Available in simplex and duplex

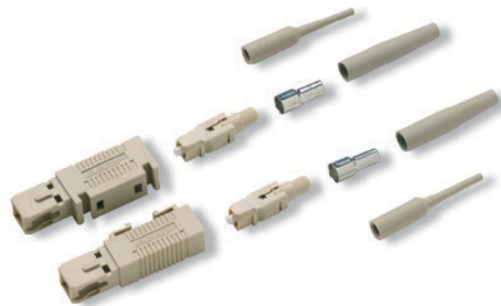

ORDERING INFORMATION

Description	Part Number
Bend limiting buffer boots (100 pcs); 0.9 mm; beige	6457493-9
Bend limiting buffer boots (100 pcs); 0.9 mm; black	6457493-3
Bend limiting cable boots (100 pcs); short; 3 mm; beige	5503971-1
Bend limiting cable boots (100 pcs); short; 3 mm; black	1-5503971-0
Bend limiting cable boots (100 pcs); short; 3 mm; red	1-5503971-1
Duplex; Ferrule: Ceramic; Boot: 3 mm; Crimp eyelet: yes; Fiber type: MM	5504657-1
Duplex; Ferrule: Ceramic; Boot: 3 mm; Crimp eyelet: yes; Fiber type: SM	5504655-1
Simplex; Ferrule: Ceramic; Boot: 0.9 mm; Crimp eyelet: no; Fiber type: MM	5504932-1
Simplex; Ferrule: Ceramic; Boot: 0.9 mm; Crimp eyelet: no; Fiber type: SM	5492123-1
Simplex; Ferrule: Ceramic; Boot: 3 mm; Crimp eyelet: yes; Fiber type: MM	5503948-1
Simplex; Ferrule: Ceramic; Boot: 3 mm; Crimp eyelet: yes; Fiber type: SM	5504646-1
Clip to connect two SC simplex- to one SC duplex connector; black.	6348522-1
Clip to connect two SC simplex- to one SC duplex connector; green.	6348522-2
Clip to connect two SC simplex- to one SC duplex connector; blue.	6348522-3
Clip to connect two SC simplex- to one SC duplex connector; beige.	6348522-4

Fiber Optic Cabling

Epoxy Connectors

ST-Style Connector Kits

FEATURES

- High performance pre-radiussed ferrules
- ST-Style compatible bayonet coupling
- Multimode or singlemode
- Durability: 0,2 dB change after 1000 cycles (MM)
- Temperature range: -20°C to +75°C
- Attenuation typ. < 0,3 dB
- Available in DieCast and overmolded (OVM) version



ORDERING INFORMATION

Description	Part Number
Bend limiting buffer boots (100 pcs); 0.9 mm; black	5503628-2
Bend limiting cable boots (100 pcs); short; 3 mm; black	501457-1
Bend limiting cable boots (100 pcs); short; 3 mm; red	501457-3
Ferrule: Ceramic; Connector body/bayonet: DieCast/Metal; 3 mm boot: no; 0.9 mm boot: yes; Crimp eyelet: yes; Fiber type: SM	502613-2
Ferrule: Ceramic; Connector body/bayonet: DieCast/Metal; 3 mm boot: yes; 0.9 mm boot: no; Crimp eyelet: yes; Fiber type: SM	5502580-2
Ferrule: Ceramic; Connector body/bayonet: OVM/Metal; 3 mm boot: no; 0.9 mm boot: no; Crimp eyelet: yes; Fiber type: MM	503676-1
Ferrule: Ceramic; Connector body/bayonet: OVM/Metal; 3 mm boot: yes; 0.9 mm boot: no; Crimp eyelet: yes; Fiber type: MM	503677-1

Fiber Optic Cabling

Splicing Products

Splice Trays

FEATURES

- Splice trays delivered with cover
- Splice protectors not included in tray

ORDERING INFORMATION

Description	Part Number
For 24 SMOUV (62 mm) splice protectors, picture A	1671281-1
For 24 ANT splice protectors, picture B	1671281-2
For 24 RECORDsplice splices, picture C	1671281-3
ANT splice protector; Packaging: 150	182398-000
SMOUV splice protector (62 mm); Packaging: 100	657054-000

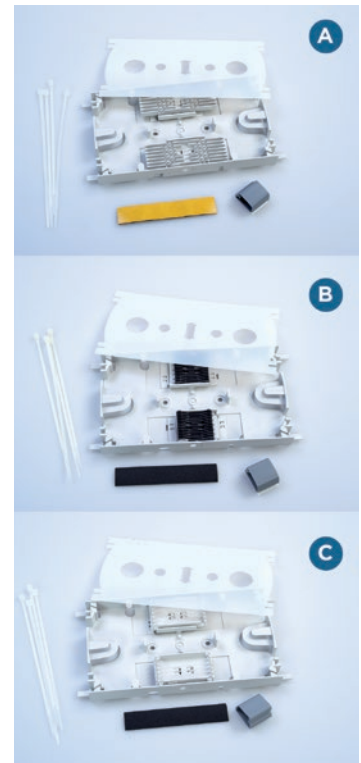

Fiber Optic Cabling

Splicing Products

AMP CORELINK Mechanical Splice

Mechanical Quick Termination

The CORELINK splice is easy to use, high performance mechanical splice for 125 μm singlemode and multimode fibers. Its unique clamping mechanism is activated with a simple key, no other tool is required. The splice is remateable - either fiber can be removed and replaced in the splice at any time.

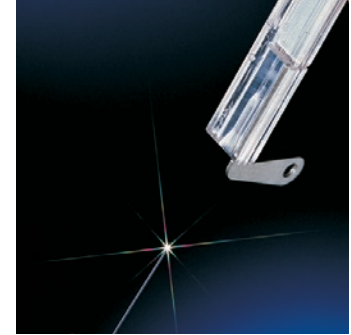

FEATURES

- No fusion splice necessary
- Torsion resistant
- Bellcore TR-765 tested
- For multimode and singlemode
- For tight buffer, semi-tight and loose tube
- For 250 μm coating and 900 μm buffer
- Cleaning Tools
- Light Crimp Universal Cleave Tool
- Fiber Optic Cleave Tool for Field Installations

TECHNICAL DATA:

Singlemode

- Color: transparent
- Attenuation typical (dB): ≤ 0.3
- Return loss typical (dB): -35 dB (min)
- Application: SM
- Temperature range: -10°C to +60°C
- Dimensions: 51 x 7.6 x 3.3 mm

Multimode

- Color: transparent blue
- Attenuation typical (dB): ≤ 0.3
- Return loss typical (dB): -20 dB (min)
- Application: MM
- Temperature range: -10°C to +60°C
- Dimensions: 51 x 7.6 x 3.3 mm

CORELINK Splices

FEATURES

- Mechanical splice
- Re-usable



ORDERING INFORMATION

Description	Part Number
12 CORELINK Splices for single- and multimode	503577-1
2 Replacement keys in key holder	503681-1

Fiber Optic Cabling

Splicing Products

Splice Holder for CORELINK Splices

FEATURES

- 31.8 x 61.0 mm Elastomer holder for 6 or 12 CORELINK splices
- For mount in splice boxes or in distribution boxes

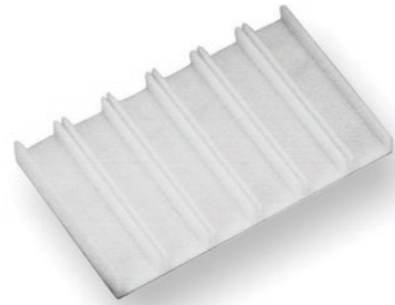

ORDERING INFORMATION

Description	Part Number
Splice holder for 6 CORELINK splices	559066-1
Splice holder for 12 CORELINK splices	559087-1

Workstation for CORELINK Splices

FEATURES

- For easy and safe installation of the CORELINK splices

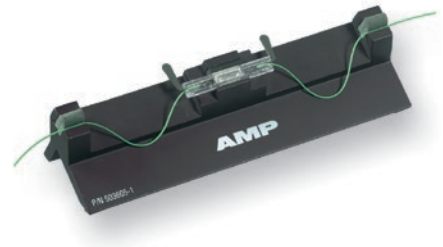

ORDERING INFORMATION

Description	Part Number
CORELINK Cleave tool	1871696-1
CORELINK Workstation	503605-1

Fiber Optic Cabling

Fiber Optic Tools

LightCrimp Plus Termination Tool Kits

FEATURES

- Termination Tool kit includes:
 - Pro-Crimper II Hand Tool and appropriate die set
 - Stripper tools
 - Kevlar scissor
 - Cable holder
 - Cleave tool



ORDERING INFORMATION

Description	Part Number
LightCrimp Plus ST-Style Connector Termination Tool Kit without microscope	492697-1
LightCrimp Plus ST-Style Connector Termination Tool Kit with microscope	492697-2
LightCrimp Plus ST-Style, SC, LC Connectors and MT-RJ Jack Termination Tool Kit without microscope	1278118-4
LightCrimp Plus ST-Style, SC, LC Connectors and MT-RJ Jack Termination Tool Kit with microscope	1278118-5
LightCrimp Plus LC/SC and LightCrimp Splice Termination Tool Kit without microscope	1553212-1
LightCrimp Plus LC + SC Connector Termination Tool Kit without microscope	1754845-1
LightCrimp Plus LC + SC Connector Termination Tool Kit with microscope	1754845-2

LightCrimp Termination Tool Kit

FEATURES

- Termination tool kit includes:
 - PRO-CRIMPER II Hand Tool and appropriate die set
 - Stripper tools
 - Kevlar scissor
 - Template strip
 - Cleave tool
 - Polishing bushings
 - Polishing films
 - Polishing plate
 - Microscope as listed
- Microscope separately available



ORDERING INFORMATION

Description	Part Number
LightCrimp SC and ST-Style; Type: Mini Tool Kit; Microscope: No Microscope	492543-1
LightCrimp ST-Style; Type: Termination Kit; Microscope: No Microscope	503330-1
LightCrimp SC and ST-Style; Type: Termination Kit; Microscope: No Microscope	503957-1
LightCrimp SC and ST-Style; Type: Termination Kit; Microscope: Premium Microscope	503957-2

Fiber Optic Cabling

Fiber Optic Tools

MT-RJ Jack Termination Tool Kit

FEATURES

- Termination tool kit includes:
 - Soft case
 - Kevlar scissors
 - MT-RJ strip length template
 - Miller strip tool
 - Actuator key
 - Cable stripper
 - Alcohol wipes
 - Micro stripper



ORDERING INFORMATION

Description	Part Number
MT-RJ Tool Kit without microscope	1278346-1
MT-RJ Tool Kit with microscope	1278346-2

Pro-Installer Epoxy/Polish Type Connector Termination Tool Kit

FEATURES

- Includes all tools necessary to install the following connectors:
 - ST-Style, TE CONNECTIVITY SC, FSD, FC, D4, FSMA
 - (Epoxy sold separately)
- Tool kits include (except otherwise specified):
 - PRO-CRIMPER II Hand Tool and crimping dies
 - Polishing bushings
 - Polishing film
 - Cable and fiber strippers
 - Scissors
 - Scribe tool
 - Microscope with tripod and power source
 - Epoxy curing oven



ORDERING INFORMATION

Description	Part Number
Tool kit with 240V curing oven and with microscope	501258-8
LC Upgrade Kit	1754462-1

Fiber Optic Cabling

Fiber Optic Tools

Epoxy/Polish Type Connector Termination Tool Kit

FEATURES

- Tool kits include:
 - Carrying case
 - PRO-CRIMPER II Hand Tool and crimping dies
 - Polishing bushings
 - Polishing film
 - Cable and fiber strippers
 - Scissors
 - Scribe tool
- Kits contain polishing materials for approximately 60 connectors (consumables can be purchased separately)
- SC tool kit can also be used to install FC Connectors



ORDERING INFORMATION

Description	Part Number
LC Upgrade Kit	1754603-1
ST-Style	503746-1
SC/FC	503746-7

Universal No Epoxy Termination Tool Kit

FEATURES

- Includes all tools necessary for installing:
 - MT-RJ jacks and MT-RJ Secure jacks
 - LightCrimp Plus ST-Style, SC and LC connectors
 - LightCrimp ST-Style and SC connectors
- Termination Tool kit includes:
 - PRO-CRIMPER II Hand Tool and appropriate die set
 - Stripper tools
 - Kevlar scissor
 - Cable holder
 - Cleave tool
 - LightCrimp Plus Termination Video CD-Rom



ORDERING INFORMATION

Description	Part Number
Universal no epoxy termination tool kit without microscope	1278949-2
Universal no epoxy termination tool kit with microscope	1278949-3

Fiber Optic Cabling

Fiber Optic Tools

LightCrimp Universal Cleave Tool

FEATURES

- Used in both SC and ST-Style LightCrimp connector terminations
- Included in all LightCrimp tool kits



ORDERING INFORMATION

Description	Part Number
LightCrimp Universal Cleave Tool	503705-1

LightCrimp Plus Cable Holder

FEATURES

- Stripping template and cable holder for LightCrimp Plus terminations
- Included in the LightCrimp Plus tool kit



ORDERING INFORMATION

Description	Part Number
LightCrimp splice cable holder	1985771-1
LC and SC	2064540-1
ST-Style	492703-1

Fiber Optic Cleave Tool for Field Installations

FEATURES

- Applicable to LightCrimp Plus Connector, MT-RJ and CORELINK termination:
- Lifespan of blade is approximately 10000 cycles
- Cleaving length: 4, 6, 8, 10, 16 mm
- For 900 μ m and 250 μ m fiber



ORDERING INFORMATION

Description	Part Number
Fiber Optic Cleave Tool	1871696-1

Fiber Optic Cabling

Fiber Optic Tools

Separate Tools

FEATURES

- Stripping tools, Micro-Stripper and Kevlar scissor for easy and save fiber preparation



ORDERING INFORMATION

Description	Part Number
Solid Steel Kevlar Scissor	501014-1
Stripping tool for cable jackets, picture A	1278531-1
Cable Jacket Clamp	1278625-1
Kevlar shears	1278637-1
Miller Stripping tool for buffer, fiber coating and 2-3 mm jackets, picture B	1754708-1
2 mm Cable Jacket Splitter, picture C	1553661-1
Micro-Stripper for 900 µm buffer (mandatory for MT-RJ jack termination), picture D	492109-2
Jacket stripper, picture E	501198-1



Pro Crimper II Hand Tool and Fiber Optic Die Sets

FEATURES

- Hand tool and die sets for fiber optic connectors



ORDERING INFORMATION

Description	Part Number
Die Set: LC Epoxy; Cable Jacket Diameter: 1.6-2.0 & 2.4 & 3.0 mm	1588175-1
Die Set: LightCrimp Plus and LightCrimp ST-Style; Cable Jacket Diameter: 2.0, 2.5 & 3.0 mm	492622-1
Die Set: LightCrimp Plus and LightCrimp SC; Cable Jacket Diameter: 2.5 & 3.0 mm	492783-1
Die Set: LightCrimp Plus LC and SC and LightCrimp Splice; Cable Diameter: 2.0 mm	1985766-1
Die Set: SC; Cable Jacket Diameter: 2.0&2.4 / 2.5 & 3.0 mm	492025-1
Die Set: SC; Cable Jacket Diameter: 3.0 mm	503910-1
Die Set: ST-Style; Cable Jacket Diameter: 3.0 mm	58424-1
Hand Tool and Die Set: LC Epoxy; Cable Jacket Diameter: 1.6 - 2.0 & 2.4 & 3.0 mm	1588176-1
Hand Tool and Die Set: LightCrimp Plus and LightCrimp SC; Cable Jacket Diameter: 2.5 & 3.0 mm	492782-1
Hand Tool and Die Set: LightCrimp Plus and LightCrimp ST-Style; Cable Jacket Diameter: 2.0, 2.5 & 3.0 mm	492623-1
Hand Tool and Die Set: LightCrimp Plus LC and SC and LightCrimp Splice; Cable Jacket Diameter: 2.0 mm	2064603-1
Hand Tool and Die Set: LightCrimp Plus LC; Cable Jacket Diameter: 1.6-2.0 mm	1754137-1
Hand Tool and Die Set: SC; Cable Jacket Diameter: 2.0&2.4/2.5&3.0 mm	492026-1
Hand Tool and Die Set: SC; Cable Jacket Diameter: 3.0 mm	503911-1
Hand Tool and Die Set: ST-Style; Cable Jacket Diameter: 3.0 mm	58433-4
PRO-CRIMPER II Hand Tool only	2064431-1

Fiber Optic Cabling

Fiber Optic Tools

Sapphire Tipped Scribe Tool and Accessories

FEATURES

- Long-lasting sapphire blade
- Pen-type casing
- For epoxy style connectors only



ORDERING INFORMATION

Description	Part Number
Sapphire tipped Scribe Tool	504064-1
Replacement Blades	504290-1

Polishing Bushings, Curing Sleeves and Strip Card Kit

FEATURES

- Polishing bushings for all polishing processes
- Curing sleeves for safe oven application



Polishing Bushing 2.5 mm

ORDERING INFORMATION

Description	Part Number
Curing sleeve; Used with: LC 900 µm; Notes: 12 pcs	1457630-1
Curing sleeve; Used with: LC jacketed cable; Notes: 12 pcs	1457630-2
Strip Card Kit; Used with: LC Connectors; Notes: -	1588756-1
Polishing bushing; Used with: Ceramic LC Connectors; Notes: -	1754074-1
Strip Card Kit; Used with: ST-Style and SC Connectors	501818-1
Alcohol Wipes 200 packet/box	501857-2
Curing sleeve; Used with: Ceramic, stainless steel and Polymer composite ST-Style connectors; Notes: 12 pcs.	502259-1
Polishing bushing; Used with: SC Connectors; Notes: black Polymer	502631-1
Curing sleeve; Used with: SC Connectors; Notes: 1 pc.	502656-1
Polishing bushing; Used with: Ceramic, stainless steel and Polymer composite ST-Style connectors; Notes: black Polymer	503304-1
Polishing bushing; Used with: Ceramic and stainless steel ST-Style connectors; Notes: Metal	503337-1
Polishing bushing; Used with: SC Connectors; Notes: Metal	503787-1



Polishing Bushing SC



SC Curing Sleeve

ST-Style Curing Sleeve
2.5 mm bayonette

Fiber Optic Cabling

Fiber Optic Tools

Polish Pads

FEATURES

- Acryl polishing plate
- Self-adhesive polishing pad

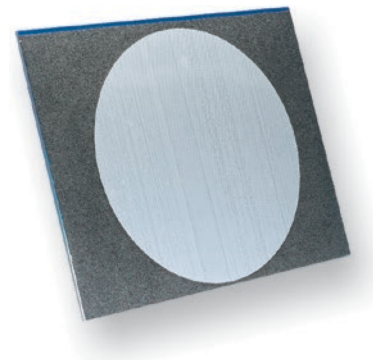

ORDERING INFORMATION

Description	Part Number
Polishing plate 8.5x11 inch	501197-1
Polishing pad for polymer ferrules 21 cm diameter, white, self-adhesive	501523-1
Polishing pad for ceramic ferrules 21 cm diameter, white, self-adhesive	501858-1

Epoxy Curing Oven

FEATURES

- Reduces time required to cure epoxy in fiber optic connectors
- Accepts all TE CONNECTIVITY Fiber Optic Connectors that require epoxy
- Comes equipped to cure up to four duplex connectors and 12 simplex connectors at once
- Optional blocks to allow up to 8 duplex and 24 simplex connectors available
- Variable temperature control (60°C to 125°C)
- Includes thermometer and cable support bracket



ORDERING INFORMATION

Description	Part Number
Adapter block for 1.6, 2.0 and 2.4 mm SC and LC connectors	1457628-1
Adapter block for 24 single connectors	502129-1
Curing oven (220 Volt) incl. adapter block for 16 connectors	502134-2
Adapter block for 8 duplex connectors	502222-1

EPO-TEK 353ND epoxy

FEATURES

- Pre-measured bi-packs for consistent results
- Ideal for bonding fibers and optical components
- Long pot life
- Heat-cured and room-temperature epoxy
- High service temperature
- Supplied in 4-gram packs



ORDERING INFORMATION

Description	Part Number
EPO-TEK 353ND; Cure time/Temp.: 10min @ 115°C; Pot life: +/- 30 min; Color after Curing: red; Viscosity (cps): 2000; Max. Temp.: 200°C; Glass transition-temp: 124°C	504035-1

Fiber Optic Cabling

Fiber Optic Tools

TRA-CON (R) and Hysol (R) Epoxy

FEATURES

- General purpose epoxy for SC and ST-Style epoxy polish connectors
- Long pot life
- Heat-cured and room-temperature epoxy
- High service temperature



ORDERING INFORMATION

Description	Part Number
Application: For manufacturing and field use; Connectors: FDDI, ESCON, ST-Style, FSMA; Cure time and temperature: 24 hr@ 25°C, 2 hr @ 65°C; Pot life: 30 mins; Color: blue; Packaging: 25 x 2 g; Connectors pro package: 250	1918652-1
Application: For manufacturing and field-use; Connectors: all; Cure time and temperature: 30 mins @ 100°C; Pot life: 30 mins; Color: blue; Packaging: 1 x 70.8 g + 1 x 22.6 g; Connectors pro package: 400	502418-1

Adhesive Applicator Syringe and Polishing Films

FEATURES

- 3 ccl capacity
- Ideal for epoxy



ORDERING INFORMATION

Description	Part Number
Hand Polishing Film (Packet of 15); Connector Type: Epoxy-Polish LC; Grit Grade: 0.9 µm	1374484-1
Polishing Consumables; Hand Polishing Film (Packet of 10); Connector Type: Epoxi-Polish SC, Epoxi-Polish Singlemode ST-Style, Epoxi-Polish Multimode ST-Style, LightCrimp SC and ST-Style; Grit Grade: 0.3 µm	228433-5
Polishing Consumables; Hand Polishing Film (Packet of 10); Connector Type: Epoxi-Polish Multimode ST-Style, LightCrimp SC and ST-Style; Grit Grade: 1 µm	228433-7
Polishing Consumables; Hand Polishing Film (Packet of 10); Connector Type: Epoxi-Polish SC, Epoxi-Polish Singlemode ST-Style, Epoxi-Polish Multimode ST-Style, LightCrimp SC and ST-Style; Grit Grade: 5 µm	228433-8
Polishing Consumables; Hand Polishing Film (Packet of 10); Connector Type: LightCrimp SC and ST-Style; Grit Grade: 15 µm	228433-9
Adhesive applicator syringe	501473-3
Mixing cup	502282-2
Polishing Consumables; Hand Polishing Film (Packet of 5); Connector Type: Epoxi-Polish SC, Epoxi-Polish Singlemode ST-Style	502748-2

Fiber Optic Cabling

Fiber Cleaning and Inspection

Optical Fiber Inspection and Cleaning Kits

FEATURES

- Densely woven micro-fiber cloth cleans fiber optic connector tips and reduces static charge
- Reel cleaners that work with FC, SC, ST and MT-RJ connectors, as well as PARA-OPTIX products
- Stick cleaners with perforated handles for customizing length and angle
- High resolution, 200x microscope to visual inspect connectors before mating



ORDERING INFORMATION

Description	Part Number
Optical Fiber and Cleaning Kit A 1x Visual Fault Locator (VFL) with 1.25 mm Adapter 1x 200x Microscope with 2.5 mm Adapter 1x 1.25 mm (LC) Microscope Adapter 1x MT-RJ Microscope Adapter 1x MPOA Microscope Adapter 1x MPO Microscope Adapter 1x Termination Training, CD-ROM 5x 2.5 mm Stick Cleaners (10/Package) 5x 1.25 mm Stick Cleaners (10/Package) 1x One Slot Reel Cleaner 1x MT-RJ w/pins Reel Cleaner 1x SC in Bulkhead Cleaner (IBC) 1x LC IBC 1x MPO IBC 1x Premium Hardcase	2064651-1
Optical Fiber and Cleaning Kit B 1x Visual Fault Locator (VFL) with 1.25 mm Adapter 1x 200x Microscope with 2.5 mm Adapter 1x 1.25 mm (LC) Microscope Adapter 1x MT-RJ Microscope Adapter 1x Termination Training, CD-ROM 5x 2.5 mm Stick Cleaners (10/Package) 5x 1.25 mm Stick Cleaners (10/Package) 1x One Slot Reel Cleaner 1x MT-RJ w/pins Reel Cleaner 1x SC in Bulkhead Cleaner (IBC) 1x LC IBC 1x Premium Hardcase	2064651-2
Optical Fiber and Cleaning Kit C 1x Visual Fault Locator (VFL) with 1.25 mm Adapter 1x 200x Microscope with 2.5 mm Adapter 1x 1.25 mm (LC) Microscope Adapter 1x Termination Training, CD-ROM 5x 2.5 mm Stick Cleaners (10/Package) 5x 1.25 mm Stick Cleaners (10/Package) 1x One Slot Reel Cleaner 1x SC in Bulkhead Cleaner (IBC) 1x LC IBC 1x Premium Hardcase	2064651-3

Fiber Optic Cabling

Fiber Cleaning and Inspection

MPO/LC/SC/MT-RJ Cassette Cleaners

ORDERING INFORMATION

Description	Part Number
MTP/MPO with pins; Packaging: 1	1918802-1
1 Slot Reel Cleaner for MPO/LC/SC and MT-RJ; Packaging: 1	1918803-1
MT-RJ with pins Reel Cleaner; Packaging: 1	1918804-1
2 Slot reel cleaner for LC and SC; Packaging: 1	1918805-1
Cleaner Refill; Packaging: 6 rolls	1918806-1



MPO Coupler Cleaner

ORDERING INFORMATION

Description	Part Number
MPO IBC; Packaging: 1	1918809-1



Card Cleaner

ORDERING INFORMATION

Description	Part Number
Card Cleaner; Packaging: 1	1918810-1
Card Cleaner Refill; Packaging: 100 sheets	1918811-1



Cleaning Sticks for Single Fiber Couplers

ORDERING INFORMATION

Description	Part Number
2.5 mm stick cleaner; Packaging: 25 x 10	1918807-1
1.25 mm stick cleaner; Packaging: 25 x 10	1918808-1

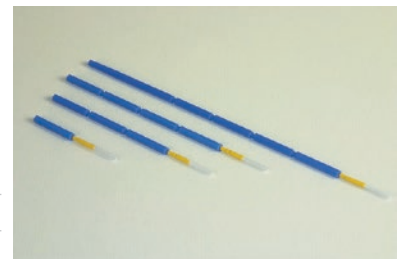

LC/SC bulkhead cleaner

ORDERING INFORMATION

Description	Part Number
SC IBC (In Bulkhead Cleaner)	2064499-1
LC IBC (In Bulkhead Cleaner)	2064500-1
LC duplex IBC (In Bulkhead Cleaner)	0-2111664-1



Fiber Optic Cabling

Fiber Cleaning and Inspection

Inspection Microscope

FEATURES

- Optimal visual examination of terminated ends
 - 500 µm field of view
 - Dual illumination
 - Coaxial for inspecting polish quality
 - Oblique for general conditions
 - Field and laboratory examination for multimode and singlemode fibers
 - Portable
 - Integral infrared filters for safety
 - Do NOT use any microscope to view active fiber signals
 - Disposable, Type LR44 batteries
 - Long-life LED (appr. 100.000 hours of operation)
-
- Each kit contains:
 - 10-power objective microscope with an impact resistant ergonomic rubber shell and high quality glass optics
 - 20-power eyepiece
 - Padded carrying case with an integrated belt loop and internal adapter storage pocket
 - Neck lanyard with safety breakaway feature
 - Universal 2.5 mm ferrule adapter (for SC, ST and FC)



ORDERING INFORMATION

Description	Part Number
1.25 mm universal (LC and MU)	1754765-1
2.50 mm universal (SC, ST-Style and FC)	1754766-1
Inspection Microscope Kit	1754767-1
MT-RJ	1754768-1
SC/APC	1828833-1
MPO Microscope Adapter	1828836-1
MPOA Microscope Adapter	1828837-1
1.25 mm universal LC duplex adapter	2123273-1
1.25 mm LC APC adapter	1553785-1

Fiber Optic Cabling

Fiber Cleaning and Inspection

Visual Fault Locator

FEATURES

- 650 µm (visible) Class 2 1.0 mW max. Diode Laser
- Continuous and flashing (2-3 Hz pulsed) modes
- Uses 1 “AA” style battery for >30 hours of continuous use
- Standard 2.5 mm adaptor for SC, ST, and FC connectors
- Optional 1.25 mm adaptor for LC and MU connectors



ORDERING INFORMATION

Description	Part Number
Hand Held Visual Fault Locator incl. 2.5 mm adaptor	1828352-1
Hand Held Visual Fault Locator incl. 2.5 + 1.25 mm adaptor	1828352-2
Adaptor for Hand Held VFL 1.25 mm	1828353-1

OTDR Launch Lead Kits for Optical Testing and Certification

FEATURES

- Each kit contains:
 - Launch and tail lead
 - Length 400 m (MM) and 500 m (SM)
 - Data sheet of end face geometry
 - Coupling bushings
 - Cleaning aides
 - Instruction manual



Y- -X	Connector Type	Y- -X	Connector Type	Y- -X	Connector Type	Y- -X	Connector Type
0- -1	SC/PC to SC/PC	0- -6	ST/PC to SC/PC	1- -1	LC/PC to SC/PC	1- -6	FC/PC to SC/PC
0- -2	SC/PC to ST/PC	0- -7	ST/PC to ST/PC	1- -2	LC/PC to ST/PC	1- -7	FC/PC to ST/PC
0- -3	SC/PC to LC/PC	0- -8	ST/PC to LC/PC	1- -3	LC/PC to LC/PC	1- -8	FC/PC to LC/PC
0- -4	SC/PC to PC/PC	0- -9	ST/PC to PC/PC	1- -4	LC/PC to PC/PC	1- -9	FC/PC to PC/PC
0- -5	SC/PC to MT-RJ	1- -0	ST/PC to MT-RJ	1- -5	LC/PC to MT-RJ	2- -0	FC/PC to MT-RJ

ORDERING INFORMATION

Description	Part Number
OM2-OM3 and OM4 Launch Lead	Y-6695240-X
OM1 Launch Lead	Y-6695242-X
OS2 Launch Lead	Y-6695244-X

Fiber Optic Cabling

Fiber Cleaning and Inspection

Power meter testlead Kits for Optical Testing and Certification

FEATURES:

- Simplex Test leads
- LSZH cable, Length 3 meter
- Data sheet of end face geometry packed per assembly
- MOQ: 6 per item

ORDERING INFORMATION



Description	Part Number
50 micron test lead for OM2-OM3 and OM4 Attenuation test	
SC/PC to SC/PC	2160547-3
SC/PC to LC/PC	2160548-3
LC/PC to LC/PC	2160549-3
9 micron test lead for SM OS1 and SM OS2 Attenuation test	
SC/PC to SC/PC	2160550-3
SC/PC to LC/PC	2160551-3
LC/PC to LC/PC	2160552-3

12. Modular Twisted Pair Cabling

Category 7_A

Cable	218
Jacks.....	219
Consolidation Point.....	220
Patch Cords.....	221

Category 7

Cable.....	225
------------	-----

Category 6_A

Cable	226
Jacks.....	227
Consolidation Point.....	229
Patch Cords.....	230

Category 6

Cable	231
Jacks.....	232
Patch Panels.....	236
Consolidation Point.....	238
Patch Cords.....	239

Category 5e

Cable	242
Jacks.....	244
Patch Panels.....	246
Consolidation Point.....	249
Patch Cords.....	250

Voice

Backbone Cable.....	253
Jacks	254
Patch Panels.....	256
LSA-PLUS.....	257
Indoor Boxes.....	262

Unloaded Hardware

Patch Panels.....	265
Consolidation Point.....	268
Mini Pods.....	269
Outlets.....	270
Surface Mount Boxes	275

Twisted Pair Tools	286
---------------------------------	-----

Modular Twisted Pair

Category 7_A - Cable

Category 7_A S/FTP Cable AWG 22

FEATURES

- High performance S/FTP cable
- Enables broadband applications like CATV, multimedia etc.
- Qualified against IEC 61156-7 and tested up to 1500MHz
- Individually foiled pairs plus overall copper braid
- AWG 22 solid conductor
- Fire retardant LSZH sheath

Color: white

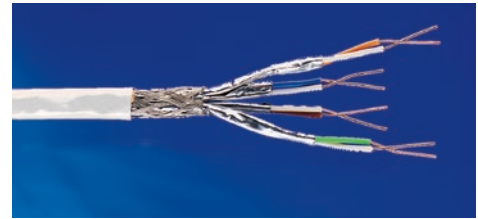

ORDERING INFORMATION

Description	Part Number
AWG 22; Type: Simplex; OD 8.1 mm; Packaging: 1000 m/Reel	1499101-1
AWG 22; Type: Duplex; OD 8.1 x 16.5 mm; Packaging: 500 m/Reel	1711003-1

Category 7_A S/FTP Cable AWG 23

FEATURES

- High performance S/FTP cable
- Qualified against IEC 61156-5 Category 7_A and tested up to 1200MHz
- Individually foiled pairs plus overall copper braid
- AWG 23 solid conductor
- Fire retardant LSZH sheath

Color: white

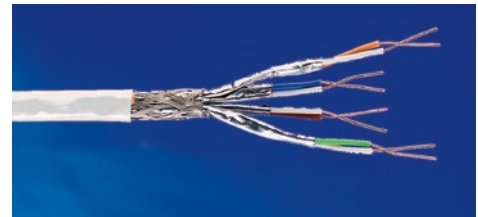

ORDERING INFORMATION

Description	Part Number
AWG 23; Type: Simplex; OD 7.9 mm; Packaging: 1000 m/Reel	1711910-1
AWG 23; Type: Duplex; OD 7.9 x 16.0 mm; Packaging: 500 m/Reel	1711913-1

Modular Twisted Pair

Category 7_A - Jacks

AMP-TWIST 7_AS SL Jack

FEATURES

- 4 chamber connector, fully compatible to IEC 61076-3-104 Ed. 2, 1000 MHz
- Class F_A / Category 7_A as per ISO/IEC 11801 Ed.2 Amd.2
- Termination time less than 1.5 minutes using TE's AWC technique
- Easiest installation with only 2 parts
- Patented shield clamp with integrated strain relief
- Available with or without dust cover
- Optional colored dust covers available

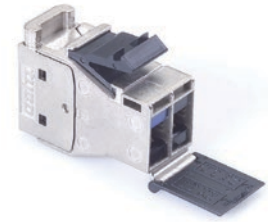

ORDERING INFORMATION

Description	Part Number
Cat. 7 _A die-cast Jack without dust cover, 180° cable exit	1711437-1
Cat. 7 _A die-cast Jack with dust cover, 180° cable exit	1711441-1
Colored dust cover (in bag of 50 pieces); Color: blue	1-1711481-6
Colored dust cover (in bag of 50 pieces); Color: red	1-1711481-7
Colored dust cover (in bag of 50 pieces); Color: yellow	1-1711481-8
Colored dust cover (in bag of 50 pieces); Color: green	1-1711481-9

Modular Twisted Pair

Category 7_A - Consolidation Point

AMP-TWIST 7_AS Consolidation Point Transition Cable Assemblies

FEATURES

- Assembly to connect the work area outlet with the consolidation or transition point
- Saves time and money on moves, adds and changes
- Slim line design for High-Density solutions
- According to ISO/IEC 11801
- Cat. 7_A S/FTP solid cable acc. to IEC 61156-7
- LSFRZH sheath

Color: white

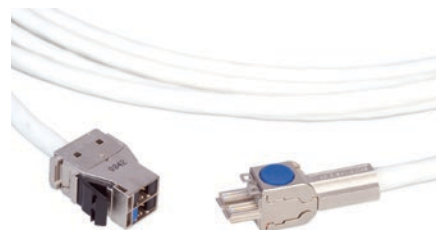

ORDERING INFORMATION

Description	Part Number
AMP-TWIST 7 _A S SL jack w/o dust cover to AMP-TWIST 7 _A S plug; Class F _A	Y-1711579-X
AMP-TWIST 7 _A S SL jack with dust cover to AMP-TWIST 7 _A S plug; Class F _A	Y-1711776-X

Y- -X	Length
0- -5	5.0 m
1- -4	7.5 m
1- -0	10.0 m
1- -5	15.0 m
2- -0	20.0 m
3- -0	30.0 m

Other lengths on request.

Modular Twisted Pair

Category 7_A - Patch Cords

AMP-TWIST 7_AS to AMP-TWIST 7_AS Patch Cord

FEATURES

- Slim line design for High-Density solutions
- Category 7_A S/FTP stranded cable
- LSZH sheath
- Black boot on AMP-TWIST 7_AS plug

Color: white

ORDERING INFORMATION

Description	Part Number
Pairs: 4; Cat. 7 _A	Y-1711637-X

Other lengths on request.



Y- -X	Length
1- -1	0.5 m
0- -1	1.0 m
0- -2	2.0 m
0- -3	3.0 m
0- -5	5.0 m
1- -0	10.0 m

AMP-TWIST 7_AS to RJ-45 Patch Cord

FEATURES

- Slim line design for High-Density solutions
- Category 7 S/FTP stranded cable
- LSZH sheath
- Black boot on AMP-TWIST 7_AS plug

Color: white

ORDERING INFORMATION

Description	Part Number
Pairs: 4; Cat. 6 _A	Y-336488-X

Other lengths on request.



Y- -X	Length
1- -1	0.5 m
0- -1	1.0 m
0- -2	2.0 m
0- -3	3.0 m
0- -5	5.0 m
1- -0	10.0 m

Modular Twisted Pair

Category 7_A - Patch Cords

AMP-TWIST 7_AS (2 Pair) to RJ-45 Patch Cord

FEATURES

- Slim line design for High-Density solutions
- Stranded shielded cable
- LSZH sheath
- Black boot on AMP-TWIST 7_AS plug

Color: white



Y- -X	Length
1- -1	0.5 m
0- -1	1.0 m
0- -2	2.0 m
0- -3	3.0 m
0- -5	5.0 m
1- -0	10.0 m

ORDERING INFORMATION

Description	Part Number
Pairs: 2 (Ethernet 12/36); Cat. 5E	Y-1711613-X
Pairs: 2 (ISDN 36/45); Cat. 5E	Y-1711618-X

Other lengths on request.

AMP-TWIST 7_AS Telephone Patch Cord (1 Pair)

FEATURES

- Slim line design for High-Density solutions
- RJ-11 to 1pair plug acc. to IEC 61076-3-104
- LSZH sheath
- Black boot

Color: black



Y- -X	Length
1- -1	0.5 m
0- -1	1.0 m
0- -2	2.0 m
0- -3	3.0 m
0- -5	5.0 m
1- -0	10.0 m

ORDERING INFORMATION

Description	Part Number
Pairs: 1 (Voice Application); Cat. 3	Y-1711623-X

Other lengths on request.

Modular Twisted Pair

Category 7_A - Patch Cords

AMP-TWIST 7_AS CATV Patch Cord (1 Pair)

FEATURES

- Slim line design for High-Density solutions
- PAL or male F-Series connector with integrated balun to 1 pair plug acc. to IEC 61076-3-104
- Category 7 S/FTP stranded cable
- LSZH sheath
- Black boot

Color: green

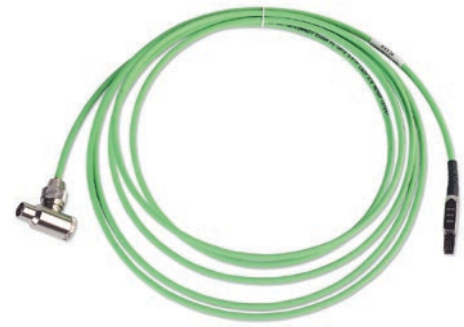

ORDERING INFORMATION

Description	Part Number
Pairs: 1 (F-conn with Balun); CATV	Y-1711624-X
Pairs: 1 (Coax with Balun); CATV	Y-1711659-X

Y- -X	Length
1- -1	0.5 m
0- -1	1.0 m
0- -2	2.0 m
0- -3	3.0 m
0- -5	5.0 m
1- -0	10.0 m

Other lengths on request.

AMP-TWIST 7_AS Single End Patch Cord

FEATURES

- Slim line design for High-Density solutions
- Category 7_A S/FTP cable
- LSZH sheath
- Black boot on AMP-TWIST 7_AS plug

Color: white



ORDERING INFORMATION

Description	Part Number
Pairs: 4; Cat. 7 _A ; Construction: Stranded	Y-1711580-X
Pairs: 4; Cat. 7 _A ; Construction: Solid	Y-1711787-X

Y- -X	Length
0- -5	5.0 m
1- -4	7.5 m
1- -0	10.0 m
1- -5	15.0 m
2- -0	20.0 m
3- -0	30.0 m

Other lengths on request.

Modular Twisted Pair

Category 7_A - Patch Cords

Category 7_A ARJ-45 Patch Cord

FEATURES

- Ideal for installations in combination with AMP CO Plus ARJ-45 Cat. 7_A
- Category 7_A S/FTP stranded cable
- ARJ-45 plug acc. to IEC 60603-7-7
- LSZH sheath

Color: white



ORDERING INFORMATION

Description	Part Number
ARJ-45 to ARJ-45; Cat. 7 _A	Y-1711563-X
ARJ-45 to RJ-45; Cat. 6 _A	Y-1711564-X

Y- -X	Length
0- -1	1.0 m
0- -2	2.0 m
0- -3	3.0 m
0- -5	5.0 m
1- -0	10.0 m

Modular Twisted Pair

Category 7 - Cable

Category 7 S/FTP Cable

FEATURES

- Qualified against IEC 61156-5 Category 7 and EN 50288-4-1
- Individually foiled pairs plus overall copper braid
- AWG 23 solid conductor
- Fire retardant LSZH sheath

Color: white

ORDERING INFORMATION

Description	Part Number
AWG 23; Type: Simplex; OD: 7.3 mm; Packaging: 1000 m/Reel	57893-1
AWG 23; Type: Duplex; OD: 7.6 x 16.0 mm; Packaging: 500 m/Reel	1711005-1

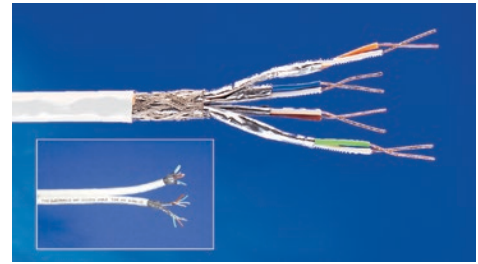

Category 7 F/FTP Cable

FEATURES

- Qualified against IEC 61156-5 Category 7 and EN 50288-4-1
- Individually foiled pairs plus overall foil shield and drain wire
- AWG 23 solid conductor
- LSZH sheath

Color: white

ORDERING INFORMATION

Description	Part Number
AWG 23; Type: Simplex; OD: 7.4 mm; Packaging: 500 m/Reel	1711163-1
AWG 23; Type: Duplex; OD: 7.2 x 15.0 mm; Packaging: 500 m/Reel	1711195-1

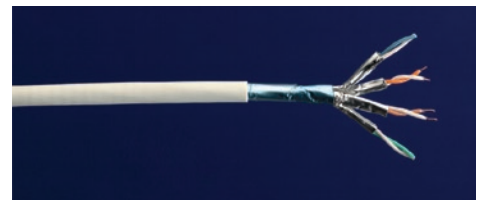

Category 7 S/FTP Outdoor Cable

FEATURES

- Qualified against IEC 61156-5 Category 7 and EN 50288-4-1 and tested up to 600MHz
- Suitable for 10GBase-T applications
- Can be used for direct burial and cable duct installation
- Individually foiled pairs plus overall copper braid
- Double jacketed:
- Inner jacket material: LSZH
- Outer jacket material: PE black, UV resistant
- Moisture barrier (plastic coated aluminum tape) in between jackets
- AWG 23 solid conductor

Color: black

ORDERING INFORMATION

Description	Part Number
AWG 23; Type: Simplex; OD 11.7 mm; Packaging: 1000 m/Reel	2153161-1



Modular Twisted Pair

Category 6_A - Cable

Category 6_A F/FTP Cable AWG 23

FEATURES

- Qualified against IEC 61156-5 Cat. 6_A and EN 50288-10-1
- Suitable for 10GBase-T applications
- Individually foiled pairs plus overall foil shield and drain wire
- AWG 23 solid conductor
- LSZH sheath according to IEC 60332-1 fire rating

Color: white



ORDERING INFORMATION

Description	Part Number
AWG 23; Type: Simplex; OD 7.0mm; Packaging: 500 m/Reel	2153290-2

Category 6_A F/UTP Cable AWG 24

FEATURES

- Qualified against IEC 61156-5 Category 6_A and EN 50288-10-1
- Suitable for 10GBase-T applications
- Overall foil shield, embedded in between synthetic tapes, with drain wire
- AWG 24 solid conductor
- LSZH sheath according to IEC 60332-1 fire rating

Color: white



ORDERING INFORMATION

Description	Part Number
AWG 24; Type: Simplex; OD 7.1mm; Packaging: 500 m/Reel	2153022-3

Category 6_A U/UTP Cable AWG 23

FEATURES

- Supports 10Gigabit Ethernet to a full 100m up to 500MHz
- UTP cable, qualified against IEC 61156-5 Category 6_A
- Patented technology with oblique elliptical offset filler to minimise the effect of alien crosstalk and insertion loss
- AWG 23 solid conductor
- LSZH sheath acc. to IEC 60332-1 fire rating

Color: blue



ORDERING INFORMATION

Description	Part Number
AWG 23; Type: Simplex; OD: 7.62mm - 6.5mm x 8.4mm; Packaging: 305m/Reel	2171014-1

Modular Twisted Pair

Category 6_A - Jacks

AMP-TWIST 6_A S SL Jack

FEATURES

- Class E_A / Category 6_A as per ISO/IEC 11801 Ed.2 Amd.2
- Termination time less than 1 minute using TE's AWC technique
- Easiest installation with only 2 parts
- Patented shield clamp with integrated strain relief
- Available with or without dust cover
- Optional colored dust covers available



ORDERING INFORMATION

Description	Part Number
Cat. 6 _A RJ-45 die-cast Jack without dust cover, 180° cable exit	1711716-1
Cat. 6 _A RJ-45 die-cast Jack with dust cover, 180° cable exit	1711592-1
Colored dust cover (bag of 50 pieces); Color: blue	1-1711691-6
Colored dust cover (bag of 50 pieces); Color: red	1-1711691-7
Colored dust cover (bag of 50 pieces); Color: yellow	1-1711691-8
Colored dust cover (bag of 50 pieces); Color: green	1-1711691-9

Q- Jack (STP)

FEATURES

- Class E_A / Category 6_A as per ISO/IEC 11801 Ed.2 Amd.2
- Suitable for Q-Jack Patch Panels (Page 287)
- Punch down termination onto LSA-PLUS contacts to ensure swift installation
- Shielded cap ensures full 360° bonding and grounding
- Universal wiring - T568 A or B wiring pattern



ORDERING INFORMATION

Description	Part Number
Cat. 6 _A RJ-45 shielded Jack without dust cover (blister pack of 12 units); Color: black (RAL 9005)	300001743975

RJ45 STP KM8 Modular Jacks

FEATURES

- Class E_A / Category 6_A as per ISO/IEC 11801 Ed.2 Amd.2
- Keystone design ensures compatibility with a range of faceplates and adaptors
- KM8 design provide built-in conductor management
- LSA-PLUS quick connection technique with highly reliable wire termination method
- Shielding clamp ensures full 360° bonding and grounding
- Universal wiring - T568 A or B wiring pattern



ORDERING INFORMATION

Description	Part Number
Cat. 6 _A RJ-45 shielded Jack without dust cover; Color: white (RAL 9010)	6830 1 811-01
Cat. 6 _A RJ-45 shielded Jack without dust cover; Color: black (RAL 9005)	6830 1 811-04

Modular Twisted Pair

Category 6_A - Jacks

AMP-TWIST 6_AU SL Jack

FEATURES

- Class E_A as per ISO/IEC 11801 Ed.2 Amd.2
- Termination time less than 1 minute using TE's AWC technique
- Easiest installation with only 2 parts
- Superior technology to reduce alien crosstalk
- Available with or without dust cover
- UL listed
- Universal wiring - T568 A or B wiring pattern
- Several colors available on demand



X	Color
-1	Almond
-2	Black
-4	Gray
-5	Orange
-6	Blue
-7	Red
-8	Yellow
-9	Green

ORDERING INFORMATION

Description	Part Number
Cat. 6 _A RJ-45 unshielded Jack without dust cover, 180° cable exit	1933476-X
Cat. 6 _A RJ-45 unshielded Jack with dust cover, 180° cable exit	2111676-X

Q- Jack (UTP)

FEATURES

- Class E_A / Category 6_A as per ISO/IEC 11801 Ed.2 Amd.2
- Suitable for Q-Jack Patch Panels (Page 287)
- Punch down termination onto LSA-PLUS contacts to ensure swift installation
- Universal wiring - T568 A or B wiring pattern



ORDERING INFORMATION

Description	Part Number
Cat. 6 _A RJ-45 unshielded Jack without dust cover (blister pack of 12 units); Color: black (RAL 9005)	300001743978

RJ45 UTP Modular Jack

FEATURES

- Class E_A / Category 6_A as per ISO/IEC 11801 Ed.2 Amd.2
- Keystone design ensures compatibility with a range of faceplates and adaptors
- Punch down termination onto LSA-PLUS contacts to ensure swift installation
- Cap with metallic particles to mitigate alien crosstalk
- Universal wiring - T568 A or B wiring pattern

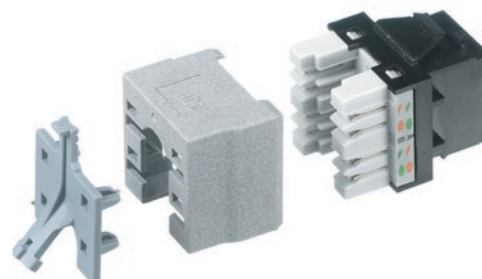

ORDERING INFORMATION

Description	Part Number
Cat. 6 _A RJ-45 unshielded Jack without dust cover; Color: white (RAL 9010)	6830 1 885-01
Cat. 6 _A RJ-45 unshielded Jack without dust cover; Color: black (RAL 9005)	6830 1 885-04

Modular Twisted Pair

Category 6_A - Consolidation Point

AMP-TWIST 6_AS Consolidation Point Transition Cable Assemblies

FEATURES

- Assembly to connect the work area outlet with the consolidation or transition point
- Saves time and money on moves, adds and changes
- According to ISO/IEC 11801
- Category 7 F/FTP solid cable according to IEC 61156-5 and EN 50288-4-1
- LSZH sheath
- Universal wiring



Color: white



ORDERING INFORMATION

Description	Part Number
AMP-TWIST 6 _A S SL jack w/o dust cover to RJ-45 plug; Class E _A	Y-1711825-X
AMP-TWIST 6 _A S SL jack with dust cover to RJ-45 plug; Class E _A	Y-1711851-X

Y- -X	Length
0- -5	5.0 m
1- -4	7.5 m
1- -0	10.0 m
1- -5	15.0 m
2- -0	20.0 m
3- -0	30.0 m

Modular Twisted Pair

Category 6_A - Patch Cords

Category 6_A S/FTP Patch Cord RJ-45 LSZH

FEATURES

- Category 7 S/FTP stranded cable
- LSZH sheath
- Color-matched snagless boots



ORDERING INFORMATION

Description	Part Number	Y- -X	Length
Color: white	Y-1711815-X	1- -1	0.5 m
Color: blue	Y-1711816-X	0- -1	1.0 m
Color: gray	Y-1711817-X	0- -2	2.0 m
Color: yellow	Y-1711818-X	0- -3	3.0 m
Color: red	Y-1711819-X	0- -5	5.0 m
Color: green	Y-1711820-X	1- -0	10.0 m

Other colors and lengths are available upon request.

Category 6_A UTP Patch Cord RJ-45 LSZH

FEATURES

- Supports 10 Gigabit Ethernet to a full 100m
- Exceeds the requirements of IEEE 802.3an (10GBASE-T) and ISO/IEC 11801:2002 amendment/channel requirements
- Superior cable flexibility from stranded cores
- Boot maintains correct bend radius to ensure maximum performance



ORDERING INFORMATION

Description	Cable Color	Cable Type	Part Number	-XX	Length
Augmented Category 6 LSZH Patch Cord RJ45 plug to RJ45 plug, T568B	Blue	LSZH UTP	6645-2-827-XX	-04	1.0 m
				-07	2.0 m
				-10	3.0 m
				-15	5.0 m
				-25	7.5 m
				-33	10.0 m

Other colors and lengths are available upon request.

Category 6_A F/FTP Solid Patch Cord RJ-45

FEATURES

- Performance exceeding Category 6_A specifications
- 4 Pair solid F/FTP cable
- LSZH sheath according to IEC 60332-1 fire rating
- Slim-line plug
- White, short boot
- Wired to T568-B

Y- -X	Length
1- -0	10.0 m
1- -5	15.0 m
2- -0	20.0 m
3- -0	30.0 m
4- -0	40.0 m
5- -0	50.0 m



ORDERING INFORMATION

Description	Part Number
Patch Cord, Solid, Category 6 _A F/FTP, LSZH, white	Y-1711826-X

Modular Twisted Pair

Category 6 - Cable

Category 6 F/FTP Cable

FEATURES

- Qualified against IEC 61156-5 Category 6 and EN 50288-5-1
- Individually foiled pairs plus overall foil shield
- AWG 23 solid conductor
- LSZH sheath

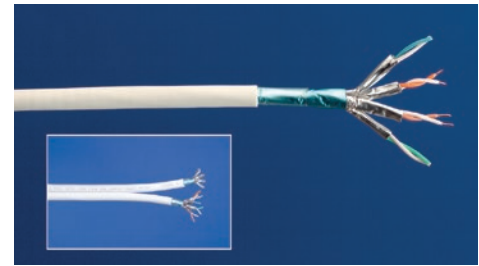

ORDERING INFORMATION

Description	Color	Part Number
AWG 23; Type: Simplex; OD: 7.3 mm; Packaging: 500 m/Reel	White	1711007-1
AWG 23; Type: Duplex; OD: 7.6 x 15.5 mm; Packaging: 500 m/Reel	White	1711008-1

Category 6 U/UTP Cable

FEATURES

- 250 MHz Category 6 U/UTP Cable
- Qualified against IEC 61156-5 Category 6 and EN 50288-6-1
- AWG 24 solid conductor (except for LSFRZH : AWG 23)
- Cross web filler to separate the pairs

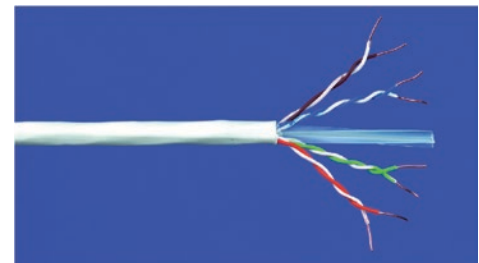

ORDERING INFORMATION

Description	Color	Part Number
Sheathing: PVC; Type: Simplex; OD 6.0 mm; Packaging: 305 m/Reel-In-A-Box	White	219584-2
Sheathing: PVC; Type: Simplex; OD 6.0 mm; Packaging: 1000 m/Reel	White	219584-3
Sheathing: LSZH; Type: Simplex; OD 6.0 mm; Packaging: 305 m/Reel-In-A-Box	White	219585-2
Sheathing: LSZH; Type: Simplex; OD 6.0 mm; Packaging: 1000 m/Reel	White	219585-3
Sheathing: LSZH; Type: Duplex; OD 6.2 x 13.0 mm; Packaging: 500 m/Reel	White	1711053-1
Sheathing: LSFRZH; Type: Simplex; OD: 6.3 mm; Packaging: 500 m/Reel	White	4-1859345-2

Category 6 U/UTP Outdoor Cable

FEATURES

- 250 MHz Category. 6 U/UTP Cable
- Double jacketed:
 - inner jacket material: LSZH
 - outer jacket material: PE
- AWG 24
- For aerial use
- Suitable in an IP65 environment

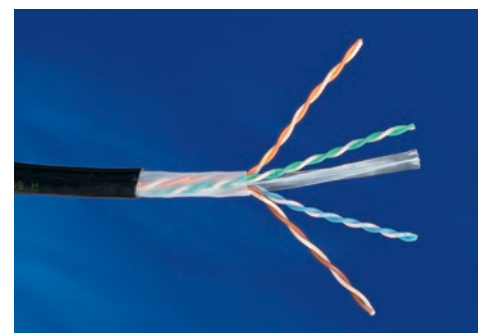

ORDERING INFORMATION

Description	Part Number
Sheathing: LSZH; OD: 7.2 mm; Packaging: 500 m/Reel	1711006-1

Modular Twisted Pair

Category 6 - Jacks

AMP-TWIST 6S SL Jack

FEATURES

- Category 6 as per ISO/IEC 11801 Ed.2 Amd.2
- Class E_A as per ISO/IEC 11801 Ed.2 Amd.1
- Termination time less than 1 minute using TE's AWC technique
- Easiest installation with only 2 parts
- Patented shield clamp with integrated strain relief
- Available with or without dust cover
- Available with rear (180°) or side (90°) cable exit
- Available DIN Rail Kit
- Optional colored dust covers available

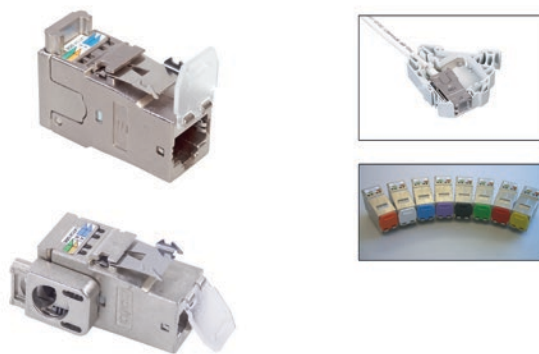

ORDERING INFORMATION

Description	Part Number
Cat. 6 RJ-45 die-cast Jack without dust cover, 180° cable exit	1711342-1
Cat. 6 RJ-45 die-cast Jack without dust cover, 90° cable exit	1711343-1
Cat. 6 RJ-45 die-cast Jack with dust cover, 180° cable exit	1711160-1
Cat. 6 RJ-45 die-cast Jack with dust cover, 90° cable exit	1711295-1
Colored dust cover (bag of 50 pieces); Color: blue	1-1711691-6
Colored dust cover (bag of 50 pieces); Color: red	1-1711691-7
Colored dust cover (bag of 50 pieces); Color: yellow	1-1711691-8
Colored dust cover (bag of 50 pieces); Color: green	1-1711691-9

RJ45 STP KM8 Modular Jack

FEATURES

- Class E / Category 6 as per ISO/IEC 11801 Ed.2 Amd.2
- Keystone design ensures compatibility with a range of faceplates and adaptors
- KM8 design provide built-in conductor management
- LSA-PLUS quick connection technique with highly reliable wire termination method
- Shielding clamp ensures full 360° bonding and grounding
- Universal wiring - T568 A or B wiring pattern



ORDERING INFORMATION

Description	Part Number
Cat. 6 RJ-45 Shielded Jack without dust cover; Color: white (RAL 9010)	6830 1 810-01
Cat. 6 RJ-45 Shielded Jack without dust cover; Color: black (RAL 9005)	6830 1 810-04

Modular Twisted Pair

Category 6 - Jacks

SL Series 110Connect Jacks (STP)

FEATURES

- Category 6 Pyramid Tested
- Universal wiring - T568 A or B wiring pattern



ORDERING INFORMATION

Description	Part Number
Cat. 6 RJ-45 shielded Jack without dust cover, 180° cable exit	1375188-1

SL Series 110Connect Jacks (UTP)

FEATURES

- SlimLine (SL) Series: Thin profile improves outlet density
- Category 6 Pyramid Tested
- Available with or without dust cover
- 90° or 180° cable dress for easy termination
- Bend-limiting strain relief included
- UL listed
- Universal wiring - T568 A or B wiring pattern
- Several colors available on demand

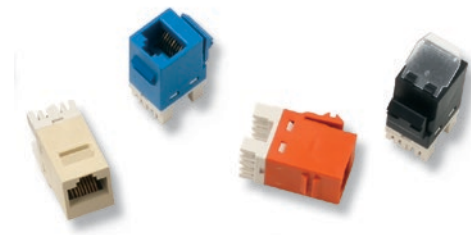

ORDERING INFORMATION

Description	Part Number
Cat. 6 RJ-45 unshielded Jack without dust cover	Y-1375055-X
Cat. 6 RJ-45 unshielded Jack with dust cover	Y-1375187-X

Y- -X	Color
0- -1	Beige
0- -2	Black
0- -3	White
0- -6	Blue
0- -7	Red

Modular Twisted Pair

Category 6 - Jacks

RJ45 UTP KM8 Modular Jack

FEATURES

- Class E / Category 6 as per ISO/IEC 11801 Ed.2 Amd.2
- Keystone design ensures compatibility with a range of faceplates and adaptors
- KM8 design provide built-in conductor management
- LSA-PLUS quick connection technique with highly reliable wire termination method
- Universal wiring - T568 A or B wiring pattern
- Several colors available on demand

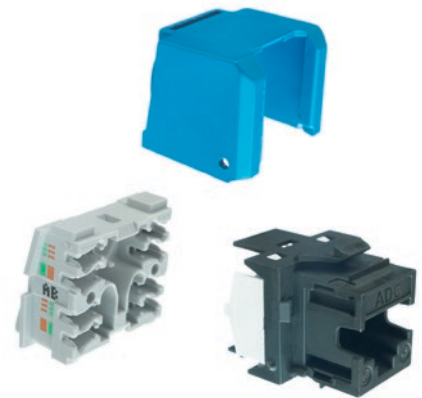

ORDERING INFORMATION

Description	Part Number
Cat. 6 RJ-45 Unshielded Jack without dust cover; Color: white (RAL 9010)	6830 1 800-01
Cat. 6 RJ-45 Unshielded Jack without dust cover; Color: black (RAL 9005)	6830 1 800-04

Modular Twisted Pair

Category 6 - Jacks

SL Series Modular Coupler

FEATURES

- Straight Category 6 coupler
- Compact coupler for two modular plugs
- SL Series: Thin profile improves outlet density

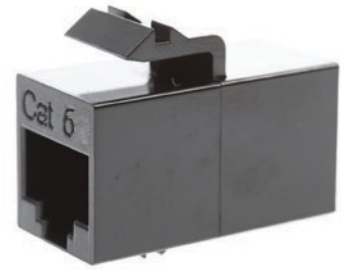

ORDERING INFORMATION

Description	Part Number
Cat. 6 RJ-45 unshielded Coupler	2111123-1
Cat. 6 RJ-45 shielded Coupler	2111124-1

Modular Twisted Pair

Category 6 - Patch Panels

Category 6 24 Ports Shielded Patch Panel

FEATURES

- 19", 1U, RJ-45 Patch Panel with 24 ports
- Class E_A Permanent Link and Category 6 Pyramid Tested
- Prepared for AMPTRAC upgrade
- Enhanced 110 IDC blocks compatible with 110C Impact or LSA-PLUS Insertion tool
- Rear cable management
- Cover adapts to different cable diameters via variable snap-in position
- Shield connection separated from strain relief
- Universal wiring - T568 A or B wiring pattern
- Including grounding bolt
- Protected PCB

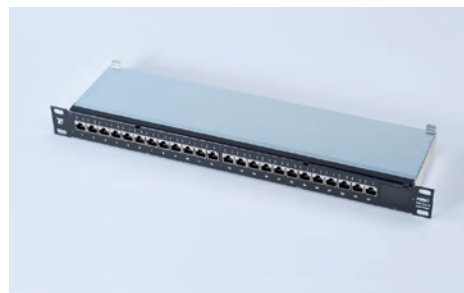

ORDERING INFORMATION

Description	Part Number
Cat. 6 24 Ports Shielded Patch Panel; Color: black (RAL 9005)	1644042-2
Cat. 6 24 Ports Shielded Patch Panel; Color: light grey (RAL 7035)	1644042-3

Category 6 24 Ports Unshielded Patch Panel

FEATURES

- 19", 1U, RJ-45 Patch Panel with 24 ports
- Category 6 Pyramid Tested
- Prepared for AMPTRAC upgrade
- Enhanced 110 IDC blocks compatible with 110C Impact or LSA-PLUS Insertion tool
- Rear cable management
- Universal wiring - T568 A or B wiring pattern
- Including grounding bolt
- Protected PCB

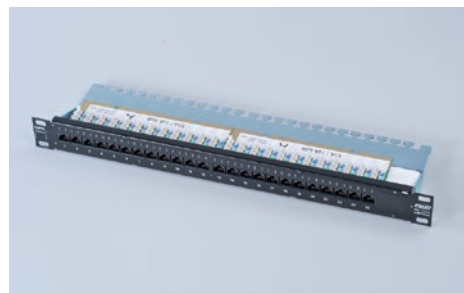

ORDERING INFORMATION

Description	Part Number
Cat. 6 24 Ports Unshielded Patch Panel; Color: black (RAL 9005)	1711147-2

Modular Twisted Pair

Category 6 - Patch Panels

MiniPods

FEATURES

- External mounting points
- Can be passed through standard floor grommets
- Incorporated dust protection on each port
- Pre-loaded with modular connectivity (including CL jacks)
- 3, 4 and 6 port versions available



ORDERING INFORMATION

Description	Part Number
MiniPod Cat. 6 CL UTP 3 port	6540 1 684-03
MiniPod Cat. 6 CL UTP 4port	6540 1 678-04
MiniPod Cat. 6 CL UTP 6 port	6540 1 678-06



Modular Twisted Pair

Category 6 - Consolidation Point

AMP-TWIST 6S to AMP-TWIST 7_AS Consolidation Point Transition Cable Assembly

FEATURES

- Assembly to connect the work area outlet with the consolidation or transition point
- Saves time and money on moves, adds and changes
- According to ISO/IEC 11801
- Category 7 S/FTP solid cable acc. to IEC 61156-5 and EN 50288-4-1
- LSFRZH sheath
- Universal wiring

Color: white

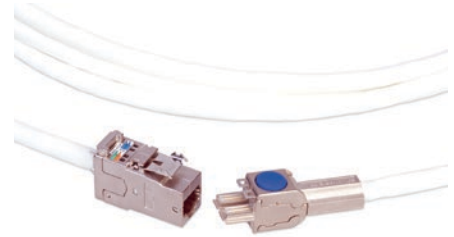

ORDERING INFORMATION

Description	Part Number
AMP-TWIST 6S SL jack w/o dust cover to AMP-TWIST 7 _A S plug; Class E _A	Y-1711666-X
AMP-TWIST 6S SL jack with dust cover to AMP-TWIST 7 _A S plug; Class E _A	Y-1711777-X

Y- -X	Length
0- -5	5.0 m
1- -4	7.5 m
1- -0	10.0 m
1- -5	15.0 m
2- -0	20.0 m
3- -0	30.0 m

Unshielded Consolidation Point Transition Cable Assemblies

FEATURES

- Assembly to connect the work area outlet with the consolidation or transition point (SL 110C Jack to modular plug)
- Meets ISO/IEC 11801 and EN 50173-1
- 4 pair solid U/UTP cable
- LSZH sheath
- Universal wiring

Color: white



ORDERING INFORMATION

Description	Part Number
Cat. 6; Class E	Y-1711027-X

Y- -X	Length
0- -5	5.0 m
1- -4	7.5 m
1- -0	10.0 m
1- -5	15.0 m
2- -0	20.0 m

Modular Twisted Pair

Category 6 - Patch Cords

Modular Solid Core Patch Cords

FEATURES

- Performance exceeding Category 6 specifications up to 250MHz
- Wired to T568-B
- Complete with integrated strain relief to protect terminations within the plug
- Fully interoperable and backwards compatible
- Maximum throughput, reliability and performance in your IT network
- Covered by the System Warranty



ORDERING INFORMATION

Description	Length	Part Number
Modular White LSZH UTP	20m	2-1711171-0
	30m	3-1711171-0
	40m	4-1711171-0
	50m	5-1711171-0

Other colors and lengths are available upon request

Modular Twisted Pair

Category 6 - Patch Cords

Category 6 S/FTP Patch Cord RJ-45 LSZH

FEATURES

- Category 7 S/FTP stranded cable
- LSZH sheath
- Color-matched snagless boots
- Universal B-wiring



ORDERING INFORMATION

Description	Part Number
Color: white	Y-959385-X
Color: gray	Y-1711076-X
Color: green	Y-1711077-X
Color: yellow	Y-1711078-X
Color: blue	Y-1711079-X

Other colors and lengths are available upon request.

Category 6 U/UTP Patch Cord RJ-45

FEATURES

- Support of POE and POE+
- Slim-line plug
- Transparent, short boot
- Universal wiring scheme (B-wiring)
- 4 pairs of AWG 24 stranded copper wires
- Jacket material complies to LSZH overall diameter: 5,4 mm ($\pm 0,3\text{mm}$)



ORDERING INFORMATION

Description	Cable Color	Part Number	Y-	-X	Length
Category 6 UTP Patch Cord RJ-45	White	Y-1711990-X	0-	-1	1.0m
	Blue	Y-1711991-X	0-	-2	2.0m
	Grey	Y-1711992-X	0-	-3	3.0m
	Yellow	Y-1711993-X	0-	-5	5.0m
	Red	Y-1711994-X	1-	-0	10m
	Green	Y-1711995-X			
	Black	Y-1711996-X			
	Orange	Y-2153217-X			

Other lengths on request.

Modular Twisted Pair

Category 6 - Patch Cords

Category 6 U/UTP Patch Cord RJ-45 LSZH

FEATURES

- Category 6 according to ISO/IEC 11801 and EN-50173-1
- 4 Pair stranded U/UTP cable
- LSZH sheath
- Color-matched snagless boots
- Universal wiring



ORDERING INFORMATION

Description	Part Number	Y- -X	Length
Color: white	Y-1711091-X	1- -1	0.5 m
Color: gray	Y-1711093-X	0- -1	1.0 m
Color: blue	Y-1711094-X	0- -2	2.0 m
Color: green	Y-1711095-X	0- -3	3.0 m
Color: red	Y-1711096-X	0- -5	5.0 m
		1- -0	10.0 m

Other colors and lengths are available upon request.

Modular Twisted Pair

Category 5e - Cables

Category 5e SF/UTP Cable

FEATURES

- Qualified against IEC 61156-5 Category 5e and EN 50288-2-1
- Overall copper braid plus foil shield
- Very low delay skew, suitable for 1000Base-T
- AWG 24 solid conductor

Color: white

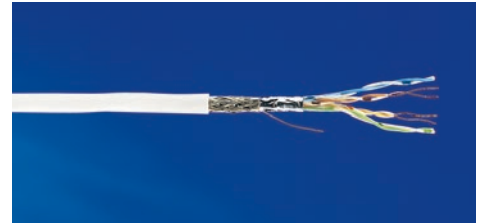

ORDERING INFORMATION

Description	Part Number
Sheathing: LSZH; Type: Simplex; OD 6.5 mm; Packaging: 500 m/Reel	219484-2

Category 5e F/UTP Cable

FEATURES

- Qualified against IEC 61156-5 Category 5e and EN 50288-2-1
- Overall foil shield with drain wire
- Very low delay skew, suitable for 1000Base-T
- AWG 24 solid conductor

Color: white

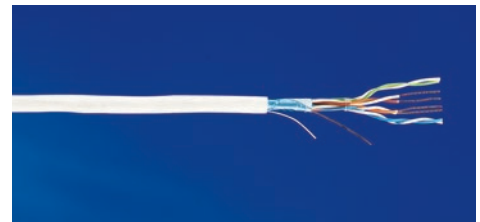

ORDERING INFORMATION

Description	Part Number
Sheathing: PVC; Type: Simplex; OD 6.2 mm; Packaging: 305 m, Pull-box	219413-2
Sheathing: PVC; Type: Simplex; OD 6.2 mm; Packaging: 1000 m/Reel	219413-3
Sheathing: LSZH; Type: Simplex; OD 6.2 mm; Packaging: 305 m, Pull-box	219420-2
Sheathing: LSZH; Type: Simplex; OD 6.2 mm; Packaging: 1000 m/Reel	219420-3
Sheathing: LSZH; Type: Duplex; OD 5.9 x 12.2 mm; Packaging: 500 m/Reel	136816-1

Modular Twisted Pair

Category 5e - Cables

Category 5e U/UTP Cable

FEATURES

- 100 MHz Category 5e UTP Cable
- AWG 24

Color: white

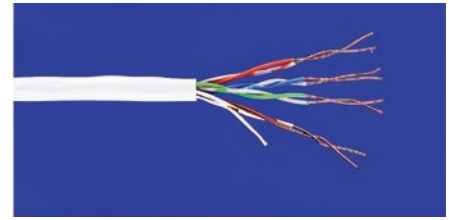

ORDERING INFORMATION

Description	Part Number
Sheathing: PVC; Type: Simplex; OD 5.1 mm; Packaging: 305 m, Pull-Box	57535-2
Sheathing: PVC; Type: Simplex; OD 5.1 mm; Packaging: 1000 m/Reel	57535-3
Sheathing: LSZH; Type: Simplex; OD 5.1 mm; Packaging: 305 m, Pull-Box	57538-2
Sheathing: LSZH; Type: Simplex; OD 5.1 mm; Packaging: 1000 m/Reel	57538-3
Sheathing: LSZH; Type: Duplex; OD 5.5 x 11.5 mm; Packaging: 500 m/Reel	1711043-1

25 Pair Category 5e PowerSum Backbone Cable

FEATURES

- Category 5e UTP Backbone Cable
- 25 Pair Construction
- AWG 24
- UL listed

Color: white



ORDERING INFORMATION

Description	Part Number
Sheathing: CMR; OD: 13.0 mm; Packaging: 305 m/Reel	1499418-1

Modular Twisted Pair

Category 5e - Jacks

SL Series 110Connect Jacks (STP)

FEATURES

- Universal wiring-T568 A or B wiring pattern
- Category 5e

ORDERING INFORMATION

Description	Part Number
Cat. 5e RJ-45 shielded Jack without dust cover, 180° cable exit	1375189-1



SL Series 110Connect Jacks (UTP)

FEATURES

- SlimLine (SL) Series: Thin profile improves outlet density
- Category 5e
- Available with or without dust cover
- 90° or 180° cable dress for easy termination
- Bend-limiting strain relief included
- UL listed
- Universal wiring - T568 A or B wiring pattern
- Several colors available on demand

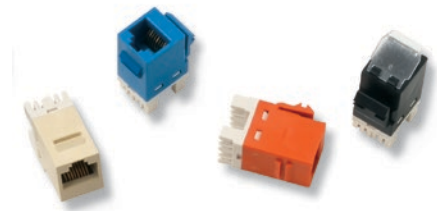

ORDERING INFORMATION

Description	Part Number
Cat. 5e RJ-45 unshielded Jack without dust cover	Y-1375191-X
Cat. 5e RJ-45 unshielded Jack with dust cover	Y-1375190-X

Y- -X	Color
0- -1	Beige
0- -2	Black
0- -3	White
0- -6	Blue
0- -7	Red

Modular Twisted Pair

Category 5e - Jacks

SL Series Modular Coupler

FEATURES

- Straight Category 5e coupler
- Compact coupler for two modular plugs
- SL Series: Thin profile improves outlet density

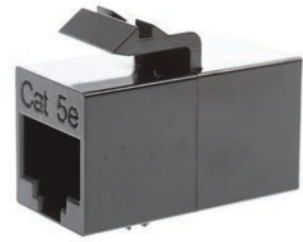

ORDERING INFORMATION

Description	Part Number
Cat. 5e RJ-45 unshielded Coupler	2111121-1
Cat. 5e RJ-45 shielded Coupler	2111122-1

Modular Twisted Pair

Category 5e - Patch Panels

Category 5e 24 Ports Shielded Patch Panel

FEATURES

- 19", 1U, RJ-45 Patch Panel with 24 ports
- Category 5e
- Available as LSA-PLUS and 110Connect Version
 - LSA-PLUS Version: Enhanced LSA-PLUS IDC blocks compatible with LSA-PLUS Insertion tool
 - 110Connect Version: Enhanced 110C IDC blocks compatible with 110C Impact tool and LSA-PLUS Insertion tool
- Rear cable management
- Shield connection separated from strain relief
- Universal wiring - T568 A or B wiring pattern
- Including grounding bolt
- Protected PCB

Color: black (RAL 9005)



ORDERING INFORMATION

Description	Part Number
Cat. 5e 24 Ports Shielded Patch Panel with 110C IDC blocks	336671-2
Cat. 5e 24 Ports Shielded Patch Panel with LSA-PLUS IDC blocks	7022 1 015-24

Modular Twisted Pair

Category 5e - Patch Panels

Category 5e 6Block Unshielded Patch Panel

FEATURES

- 19", RJ-45 Patch Panel with 24 (1U) or 48 (2U) ports
- Category 5e
- Enhanced 110 IDC blocks compatible with 110C Impact or LSA-PLUS Insertion tool
- Universal wiring - T568 A or B wiring pattern

Color: black (RAL 9005)



ORDERING INFORMATION

Description	Part Number
Cat. 5e 6Block Unshielded Patch Panel; N° of Ports: 24	406330-1
Cat. 5e 6Block Unshielded Patch Panel; N° of Ports: 48	406331-1

Category 5e 24 Ports Unshielded Patch Panel

FEATURES

- 19", 1U, RJ-45 Patch Panel with 24 ports
- Category 5e
- Enhanced LSA-PLUS IDC blocks compatible with LSA-PLUS Insertion tool
- Rear cable management
- Universal wiring - T568 A or B wiring pattern
- Including grounding bolt
- Protected PCB

Color: black (RAL 9005)

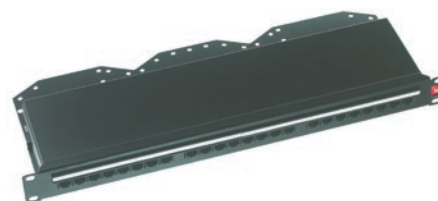

ORDERING INFORMATION

Description	Part Number
Cat. 5e 24 Ports Unshielded Patch Panel	6527 1 607-24

Modular Twisted Pair

Category 5e - Patch Panels

MiniPods

FEATURES

- External mounting points
- Can be passed through standard floor grommets
- Incorporated dust protection on each port
- Pre-loaded with modular connectivity (including CL jacks)
- 4 and 6 port versions available



ORDERING INFORMATION

Description	Part Number
MiniPod Cat. 5e CL UTP 4 port	6540 1 677-04
MiniPod Cat. 5e CL UTP 6 port	6540 1 677-06

Modular Twisted Pair

Category 5e - Consolidation Point

Unshielded Consolidation Point Transition Cable Assemblies

FEATURES

- Assembly to connect the work area outlet with the consolidation or transition point (SL 110C Jack to modular plug)
- Meets ISO/IEC 11801 and EN 50173-1
- 4 pair solid U/UTP cable
- LSZH sheath
- Universal wiring

Color: white



ORDERING INFORMATION

Description	Part Number
Cat. 5e; Class D	Y-1711040-X

Y- -X	Length
0- -5	5.0 m
1- -4	7.5 m
1- -0	10.0 m
1- -5	15.0 m
2- -0	20.0 m

Modular Twisted Pair

Category 5e - Patch Cords

Category 5e F/UTP Stranded Patch Cord RJ-45

FEATURES

- Category 5e according to ISO/IEC 11801 and EN-50173-1
- 4 Pair stranded F/UTP cable
- LSZH sheath
- Color-matched snagless boots
- Universal wiring

ORDERING INFORMATION

Description	Part Number
F/UTP; Color: gray	Y-959305-X
F/UTP; Color: green	Y-959306-X
F/UTP; Color: yellow	Y-959307-X
F/UTP; Color: blue	Y-959308-X
F/UTP; Color: red	Y-959309-X
F/UTP; Color: white	Y-1644077-X



Y- -X	Length
1- -1	0.5 m
0- -1	1.0 m
0- -2	2.0 m
0- -3	3.0 m
0- -5	5.0 m
1- -0	10.0 m

Other colors and lengths are available upon request

Modular Twisted Pair

Category 5e - Patch Cords

Category 5e UTP Stranded Patch Cord RJ-45

FEATURES

- Support of POE and POE+
- Slim-line plug
- Transparent, short boot
- Universal wiring scheme (B-wiring)
- 4 pairs of AWG 24 stranded copper wires
- Available with LSZH jacket material
overall diameter: 5,2 mm (± 0,3mm)

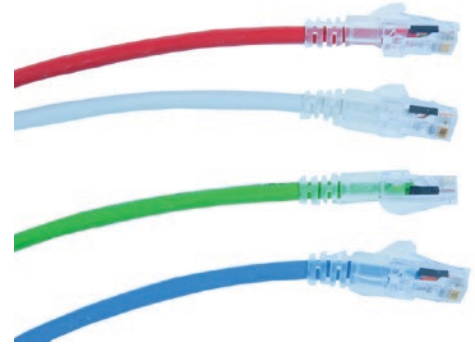

ORDERING INFORMATION

Description	Color	Part Number (LSZH jacket)	Y-	-X	Length
Category 5e UTP Stranded Patch Cord RJ-45	White	Y-2153241-X	0-	-1	1.0m
	Blue	Y-2153275-X	0-	-2	2.0m
	Grey	Y-2153278-X	0-	-3	3.0m
	Yellow	Y-2153277-X	0-	-5	5.0m
	Red	Y-2153273-X	1-	-0	10m
	Green	Y-2153274-X			
	Black	Y-2153279-X			
	Orange	Y-2153276-X			

Other lengths on request.

Modular Twisted Pair

Category 5e - Patch Cords

Category 5e UTP Solid Patch Cord RJ-45

FEATURES

- Support of POE and POE+
- Slim-line plug
- Transparent, short boot
- Universal wiring scheme (B-wiring)
- 4 pairs of AWG 24 solid copper wires
- LSZH jacket material overall diameter: 5,0 mm (\pm 0,3mm)

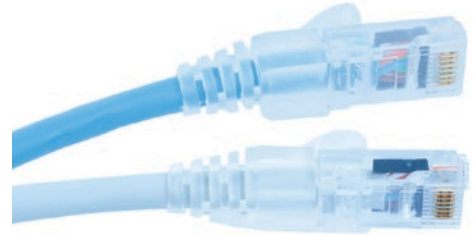

ORDERING INFORMATION

Description	Color	Part Number
Category 5e UTP Solid Patch Cord RJ-45	White	Y-2153240-X
	Blue	Y-2153285-X
	Orange	Y-2153286-X

Other lengths on request.

Y-	-X	Length
0-	-1	1,0m
0-	-5	5,0m
1-	-0	10,0m
2-	-0	20,0m
3-	-0	30,0m

Modular Twisted Pair

Voice - Backbone Cable

25 Pair Category 5e PowerSum Backbone Cable

FEATURES

- Category 5e UTP Backbone Cable
- 25 Pair Construction
- AWG 24
- UL listed

Color: white

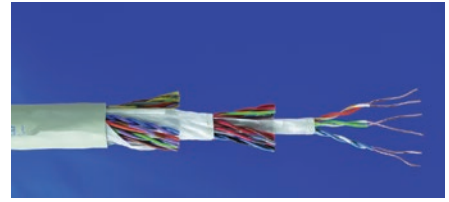

ORDERING INFORMATION

Description	Part Number
Sheathing: CMR; OD: 13.0 mm; Packaging: 305 m/Reel	1499418-1

Multi-Pair Category 3 Backbone Cable

FEATURES

- Category 3 Telephone Backbone Cable
- AWG 24
- LSZH Jacket

Color: white

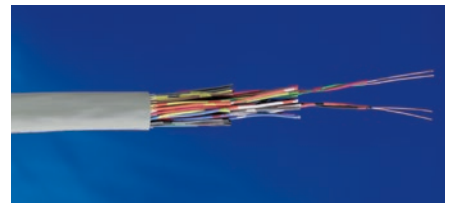

ORDERING INFORMATION

Description	Part Number
25 Pairs; OD: 13.0 mm; Packaging: 500 m/Reel	1711494-1
50 Pairs; OD: 16.0 x 29.0 mm; Packaging: 500 m/Reel	1711495-1
100 Pairs; OD: 35.0 mm; Packaging: 500 m/Reel	1711496-1

Modular Twisted Pair

Voice - Jacks

SL Series Modular Jack (UTP)

FEATURES

- SlimLine (SL) Series: Thin profile improves outlet density
- Category 3
- 90° or 180° cable dress for easy termination
- Bend-limiting strain relief included
- UL listed
- Universal wiring - T568 A or B wiring pattern
- Several colors available on demand

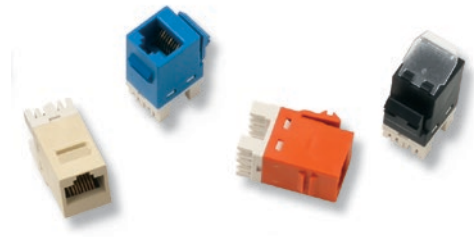

ORDERING INFORMATION

Description	Part Number
Cat. 3 RJ-11 unshielded Jack without dust cover	Y-1375192-X

Y- -X	Color
0- -1	Beige
0- -2	Black
0- -6	Blue
1- -3	Alpine White

Modular Coupler

FEATURES

- Straight Category 3 telephone coupler
- Compact coupler for two modular plugs

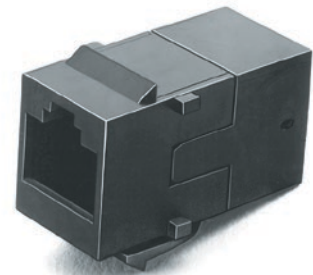

ORDERING INFORMATION

Description	Part Number
Cat. 3 RJ-11 (6 pos) unshielded Coupler	555050-1
Cat. 3 RJ-45 (8 pos) unshielded Coupler	555052-1

Modular Twisted Pair

Voice - Jacks

SL Series Multimedia Inserts

Y- -X	Color
0- -1	Light Almond
0- -2	Black
1- -3	Alpine White

FEATURES

- The inserts offer flexibility and density at the work area outlet
- Can be installed in any faceplate or outlet designed to the SL series jack footprint
- Some couplers may not be available in all colors

ORDERING INFORMATION

Description	Part Number
ST Coupler; Fiber Type: Multimode	Y-1339123-X
ST Coupler; Fiber Type: Singlemode	Y-1479181-X
BNC Coupler Insert; Figure B	Y-2111615-X
MT-RJ SL Series Housing	Y-1374416-X
RCA Coupler, Red Dielectric	Y-1375361-X
RCA Coupler, White Dielectric	Y-1375362-X
RCA Coupler, Yellow Dielectric	Y-1375363-X
RCA Solder Termination, Red Dielectric	Y-1375364-X
RCA Solder Termination, White Dielectric	Y-1375365-X
RCA Solder Termination, Yellow Dielectric	Y-1375366-X
RCA Coupler, Green Dielectric	Y-1933192-X
RCA Coupler, Blue Dielectric	Y-1933193-X
RCA Coupler, Orange Dielectric	Y-1933194-X
RCA to F-Connector; Figure I	Y-1933096-X
F-Connector Coupler, 2 GHz; Figure E	Y-1499855-X
3.5 mm Stereo Mini-Headphone, Screw Terminal, Figure F	Y-1933582-X
Speaker Post, Black Stripe	Y-1479190-X
Speaker Post, Red Stripe; Figure G	Y-1479191-X
SC Simplex Coupler; Fiber Type: Multimode or Singlemode	Y-1499836-X
LC Coupler; Fiber Type: Singlemode APC; LC Coupler and Housing, Green	1933286-3
LC Coupler; Fiber Type: Singlemode; LC Coupler and Housing, Blue	1933286-4
LC Coupler; Fiber Type: XG LO 850 nm 50/125µm; LC Coupler and Housing, Aqua, OM3 & OM4	1933286-6
LC Coupler; Fiber Type: 50/125µm; LC Coupler and Housing, Black, OM2	1-1933286-1
LC Coupler; Fiber Type: 62.5/125µm; LC Coupler and Housing, Beige, OM1	1-1933286-2
USB A-A Coupler; Figure J	Y-1933659-X
USB B-A Coupler; Figure K	Y-1933661-X
HDMI Coupler Figure H	2111500-2
Blank Insert Figure A	Y-1116412-X

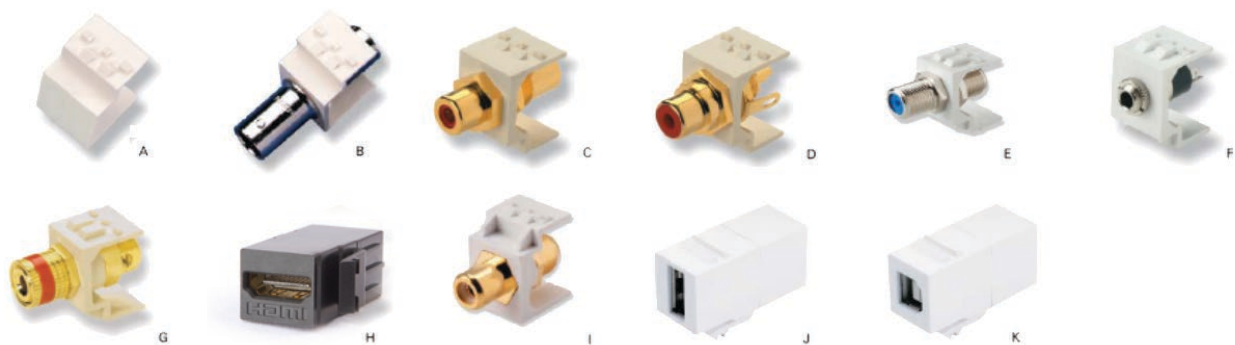

Modular Twisted Pair

Voice - Patch Panels

Category 3 Telephone Patch Panel - fixed

FEATURES

- 19", 1U, Telephone Panel with 50 ports
- Prepared for AMPTRAC upgrade
- Active Pin-out: 36,45
- Enhanced 110 IDC blocks compatible with 110C Impact or LSA-PLUS Insertion tool
- Conductor diameter range from AWG 26-22 (0.4-0.65 mm)
- Rear cable management for multipair cables
- 110 IDC blocks for conductor insulation diameters up to 1.28 mm

Color: black (RAL 9005)

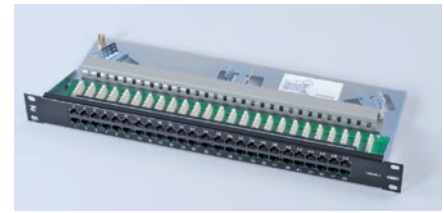

ORDERING INFORMATION

Description	Part Number
Cat. 3; 50 Ports Telephone Patch Panel - fixed; 110C IDC blocks	1394060-2

Category 3 Telephone Patch Panel - sliding

FEATURES

- 19", 1U, Telephone Panel with 25 or 50 ports
- Active Pin-out: 36,45
- Enhanced LSA-PLUS IDC blocks compatible with LSA-PLUS Insertion tool
- Expansive cable management for maximum cable protection
- Innovative sliding panel mechanism for improved ease of installation

Color: black (RAL 9005)

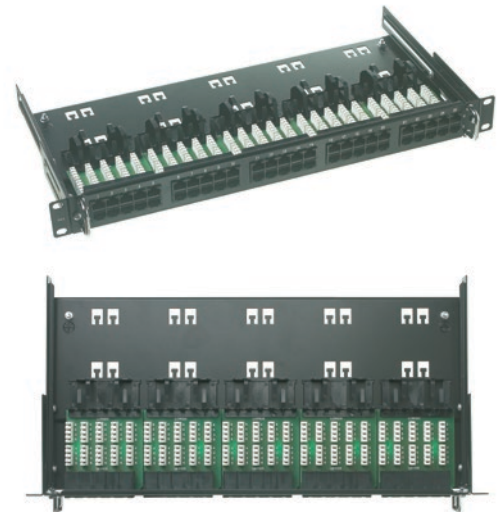

ORDERING INFORMATION

Description	Part Number
Cat. 3; 25 Ports Telephone Patch Panel - sliding; LSA-PLUS blocks	7022 4 001-25
Cat. 3; 50 Ports Telephone Patch Panel - sliding; LSA-PLUS blocks	7022 4 001-50

Modular Twisted Pair

Voice - LSA-PLUS

LSA-PLUS Series 2 Backmount Disconnection Module

10 pair LSA-PLUS modules which contain two piece contacts normally closed. Has advantage of individual pair disconnection and four wire test access.



ORDERING INFORMATION

Description	Part Number
LSA-PLUS Backmount Disconnection Module, White, Pack of 10	6089 1 102-02
LSA-PLUS Backmount Disconnection Module, Cream, Pack of 10	6089 1 810-00

10 Pair Label Holder and Labels

Easy identification of terminations and groups of modules. Label holders are available for mounting on 10 pair LSA-PLUS modules and for mounting directly onto the backmount frame. Labels can be ordered separately.



ORDERING INFORMATION

Description	Quantity	Part Number
Double Sided Hinged Label Holder Grey	Pack of 10	6092 1 810-00
Label Holder Complete with Label, fits on one position on backmount frame	Pack of 10 Strips	6092 1 820-00
Blank white labels for use with label holders 6092 1 810-00 & 6092 1 840-00	Pack of 100	6534 1 001-00

PROFIL Module Label Holder

Designed for universal use with backmount frame and PROFIL rod systems. For vertical identification

Label size: 95 x 18 mm for 2/10

Requires the space of one connection module in the backmount frame / PROFIL rod system.



ORDERING INFORMATION

Description	Part Number
PROFIL Module Label Holder	6753 2 009-00

Modular Twisted Pair

Voice - LSA-PLUS

LSA-PLUS Series 2 Connection Cord

Equipped with a plug at each end of the cord. Primarily used for interconnecting separate circuits either on the same or between different LSA-PLUS modules.



ORDERING INFORMATION

Description	Quantity	Part Number
2 Pole. For use with LSA-PLUS connection and disconnection modules, cord length 1.5m	Pack of 10	6529 1 022-01
4 Pole. For use with LSA-PLUS switching and disconnection modules, cord length 1.5m	Pack of 10	6529 1 042-01

ComProtect Series B

Compact plug-in single pair overvoltage protection for LSA-PLUS series. ComProtect Series B protects from damage caused by overvoltage with a 3-pole GDT with failsafe (primary circuit) and transient secondary elements (Diodes) for quick responding fine protection. Additional overcurrent protection is realised with reversible thermistors (PTCs) that complete the 5 point protective circuitry. These devices are designed for use in exchanges and terminal equipment in both analogue and ISDN (<2MBps) systems. All include earthing rail.



ORDERING INFORMATION

Description	Quantity	Part Number
CP BI12A1 - 5 point and transient protection, max. operating voltage is 12V, GDT with failsafe	10	5909 1 084-00
CP BI24A1 - as above, max. operating voltage is 24V	10	5909 1 083-00
CP BI70A1 - as above, max. operating voltage is 70V	10	5909 1 082-00
CP BI180A1 - as above, max. operating voltage is 180V	10	5909 1 076-00
CP BOD180A2 - high GDT clamping voltage (>250V)	10	5909 1 078-10

Modular Twisted Pair Voice - LSA-PLUS

Backmount Frames

Backmount frames in a variety of sizes, suitable for LSA-PLUS Series 2 Modules.

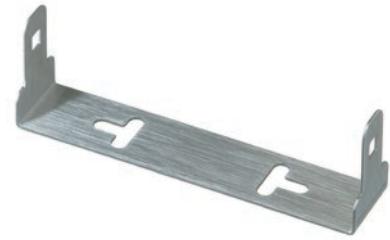

ORDERING INFORMATION

Description	Quantity	Part Number
11mm Deep, 1 Module	1	6424 3 005-01
11mm Deep, 2 Modules	1	6424 3 005-02
11mm Deep, 7 Modules	1	6424 3 005-07
30mm Deep, 10 Modules	1	6424 3 007-10
50mm Deep, 30 Modules	1	6424 3 009-30
60mm Deep, 34 Modules	1	6424 3 010-34

PROFIL Frame 95/46

For installation in already set-up distribution frames and distribution cabinets.

- The frame consists of:
 - 2 PROFIL rods, 12mm in diameter (stainless steel)
 - An adequate number of PROFIL holders with a depth of 46mm
- Completely assembled PROFIL frame:
 - PROFIL frame 95 for accommodation of LSA PROFIL modules 2/10, 2/8-95, LS 10 pairs and HighBand*

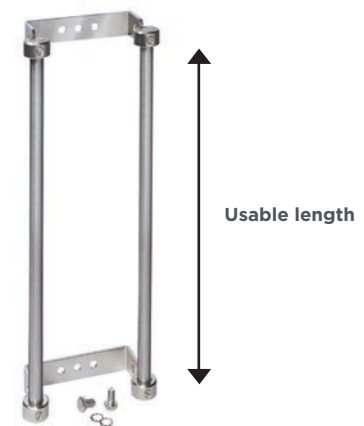

ORDERING INFORMATION

Description	Part Number
PROFIL Frame 95/46, length of rods 299mm	6577 2 812-01
PROFIL Frame 95/46, length of rods 574mm	6577 2 812-02
PROFIL Frame 95/46, length of rods 861mm	6577 2 812-03
PROFIL Frame 95/46, length of rods 1136mm	6577 2 812-04
PROFIL Frame 95/46, length of rods 1423mm	6577 2 812-05
PROFIL Frame 95/46, length of rods 1698mm	6577 2 812-06

Modular Twisted Pair

Voice - LSA-PLUS

LSA-PROFIL Series HD180 Disconnection module

Space saving module for 10 copper pairs. The cable side is to be permanent connected to to back side. The front side is for test access and jumper wires. Mounting pitch on PROFIL rods is 13.5 mm.

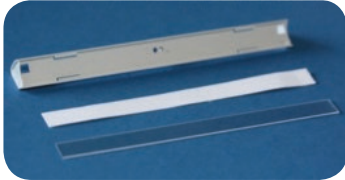

Hinged label holder for LSA-PLUS HD180 modules
(LSA-7014 2 058-00)



LSA-PLUS HD180 Label holder for backmount-frames and Profile rods
(LSA-7014 2 065-00)

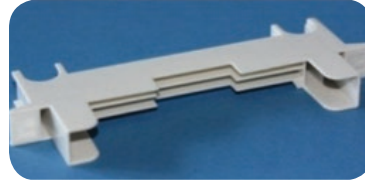

Mounting aid for LSA-PROFIL HD180 disconnection modules
(LSA-7014 3 252-00)



LSA-PLUS HD180 test cord
(7014 2 003-00)



LSA-PLUS HD180 test cord
(7014 2 004-00)

ORDERING INFORMATION

Description	Part Number
LSA-PROFIL HD180 Disconnection Module, 10 pairs	LSA-7014 2 250-00
Hinged label holder for LSA-PLUS HD180 modules, with clear cover and blank paper label. Label size: 98.5 x 8.2 mm. Fits directly on a HD180 module and covers it	LSA-7014 2 058-00
LSA-PLUS HD180 Label holder for backmount-frames and PROFIL rods. Label Size: 98,5 x 8,2 mm. Does not cover a module; needs a mounting position on backmount-frames or PROFIL rods (10.5 mm)	LSA-7014 2 065-00
Mounting aid for LSA-PROFIL HD180 disconnection modules. Helps to hold the module in place during back side cable termination	LSA-7014 3 252-00
LSA-PLUS HD180 test cord, 2-pin Length: 0.2 m Suitable for LSA-PLUS HD180 connection and disconnection modules Parallel test access	7014 2 003-00
LSA-PLUS HD180 test cord, 4-lead parallel tap for individual testing in both directions. Interrupts the line. Length: 0.2 m Suitable for LSA-PLUS HD180 disconnection modules	7014 2 004-00

Modular Twisted Pair

Voice - LSA-PLUS

NTP OD180A2

Recommended for protection of distribution and terminal equipment in analog, ISDN, HDSL and ADSL telecommunication systems. Designed for the partial or complete equipping of HD180 disconnection or switching modules in conjunction with a 10-pair earth bar (Order No.: PRO-7019 3 237-00).

The protection circuit consists of a 3-pole overvoltage arrestor, fail-safe contact, reversible overcurrent protection components and diodes for secondary overvoltage protection. The overcurrent protection functions as a reversible line fuse.



ORDERING INFORMATION

Description	Part Number
NTP OD180A2	7019 1 214-00

Modular Twisted Pair

Voice - Indoor Boxes

Connection Box 201D

Low profile plastic box accommodates up to 20 pairs or 2 LSA-PLUS modules.

Dimensions: 170(H) x 120(W) x 43(D)mm

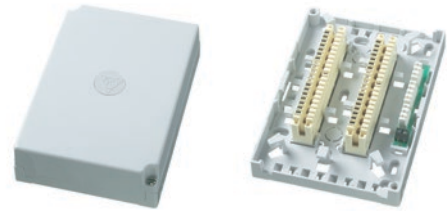

ORDERING INFORMATION

Description	Part Number
Connection Box 201D, 20 Pair	6429 1 076-00
Connection Box 201D, 10 Pair	6429 1 078-00

Connection Box 301A

Plastic modular box, for 100 pairs designed to accommodate 10 LSA-PLUS 10 pair modules.

Dimensions: 320(H) x 210(W) x 120(D)mm

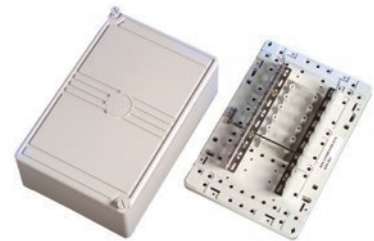

ORDERING INFORMATION

Description	Part Number
Connection Box 301A (Includes 1 backmount frame 5/30/10A equivalent and earthing)	6530 1 017-00

Modular Twisted Pair

Voice - Indoor Boxes

KRONECTION Boxes

FEATURES

- Plastic Distribution Box for Surface- and flush-mounted applications
- KRONECTION boxes with back-mount frames are designed for installation of overvoltage protection elements (additional wall attachment frame required)
- Protection class: IP 30 according to DIN 40050. These distribution boxes are designed for indoor use.
- Flammability class: UL 94V-0

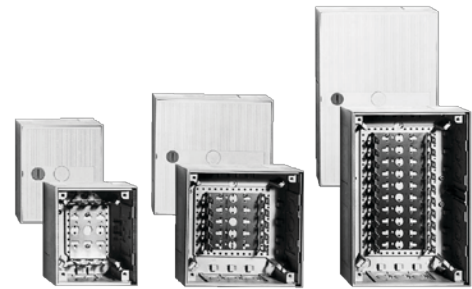

Color: RAL 7035 (polystyrene-compatible paintings possible).

ORDERING INFORMATION

Description	H x W x D (mm)	Part Number
KRONECTION-Box I (outfitted with 1 back-mount frame for 3 LSA-PLUS modules 2/10)	170 x 140 x 75	6436 1 013-xx
KRONECTION-Box II (outfitted with 1 back-mount frame for 5 LSA-PLUS modules 2/10)	215 x 215 x 75	6406 1 015-xx
KRONECTION-Box III (outfitted with 1 back-mount frame for 10 LSA-PLUS modules 2/10)	320 x 215 x 75	6437 1 020-xx

xx = 20 for door with turnbuckle

xx = 21 for door with cylinder lock and one key

Accessories for KRONECTION-Box I, II, III

FEATURES

- Mounting frames available as flush-mount or for attachment
- Attachment frames for increasing the installation depth by 37 mm for overvoltage protection applications

ORDERING INFORMATION

Description	Part Number
Flush-mounting frame for KRONECTION-Box I	6436 2 004-20
Attachment frame for KRONECTION-Box I	6436 3 003-20
Flush-mounting frame for KRONECTION-Box II	6406 2 004-20
Attachment frame for KRONECTION-Box II	6406 3 003-20
Flush-mounting frame for KRONECTION-Box III	6437 2 004-20
Attachment frame for for KRONECTION-Box III	6437 3 003-20
Cylinder lock for replacing the turnbuckle incl. one key	6437 2 010-00
Jumper pin as wire guide (6 pieces)	6406 2 013-00



Flush-mounting frame

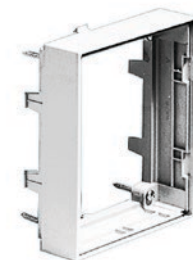

Attachment frame

Modular Twisted Pair Voice - Indoor Boxes

LSA Connection Boxes

FEATURES

- Manufactured from lightweight 1mm mild steel
- Removable top and bottom gland plates and internal jumper rings
- Quick release hinges
- Doors can be hinged either left or right
- Strong, robust and durable solution
- Tidy cable management
- Quick release hinges aid and simplify installations
- Increased flexibility



ORDERING INFORMATION

Description	Pairs Capacity	Backmount Frames	Dimensions (mm) WxHxD	Weight (Kg)	Jumper rings	Pack Qty	Part Number.
Connection Box 500 Series	100	1 x 10 way	235x350x115	3.2	4	1	6428 2 421-00
Connection Box 500 Series	200	1 x 20 way	235x700x115	5.2	6	1	6428 2 420-00
Connection Box 500 Series	200	2 x 10 way	425x350x115	5.4	6	1	6428 2 418-00
Connection Box 500 Series	400	2 x 20 way	425x700x115	8.6	9	1	6428 2 419-00
Connection Box 510	340	1 x 34 way	300x1000x140	11	8	1	6428 2 423-00
Connection Box 520	680	2 x 34 way	500x1000x140	17	12	1	6428 2 424-00
Connection Box 530	1020	3 x 34 way	750x1000x140	25	16	1	6428 2 425-00
Connection Box 540	1340	4 x 34 way	1000x1000x140	32	20	1	6428 2 422-00

Modular Twisted Pair

Unloaded Hardware - Patch Panels

UCP Patch Panel Angled and Flushmount

FEATURES

- 19" 1U unloaded modular patch panel with support for 4 Quick-Fit Modules
- Angled and flush style panels available
- Modular, rear cable management for both horizontal Copper and Fiber cables
- Accepts Pre-terminated Cu or FO cassettes or Field-terminated Copper modules
- Including grounding bolt

Color: black (RAL 9005)

ORDERING INFORMATION

Description	Part Number
UCP Patch Panel 1U Angled	1-1671590-1
UCP Patch Panel 1U Flush	1-1671594-1
UCP Patch Panel 1U Angled w/o cable bracket	0-1671590-1
UCP Patch Panel 2U Angled w/o cable bracket	0-1671590-2
UCP Patch Panel 4U Angled w/o cable bracket	0-1671590-4



Angled 1U Modular Panel (unloaded)

FEATURES

- 19" 1U angled modular Patch Panel to be equipped with different Slim Line jacks
- Adjustable & removable rear cable bracket incl. easy to use cable organizing CaRe-clips
- Including grounding bolt

Color: black (RAL 9005)

ORDERING INFORMATION

Description	Part Number
Angled modular panel UTP	1-1671157-1
Angled modular panel STP	1-1671157-2



Modular Twisted Pair

Unloaded Hardware - Patch Panels

Flushmount AMPTRAC *Ready!* Patch Panel (unloaded)

FEATURES

- 19" 1U unloaded flushmount panel to be equipped with different SlimLine jacks
- AMPTRAC *Ready!* version: prepared for AMPTRAC upgrade
- Holds up to 24 SL jacks

Color: black (RAL 9005)

ORDERING INFORMATION

Description	Part Number
AMPTRAC <i>Ready!</i> unloaded panels for all SL jacks; Color: black (RAL 9005)	1711685-1
AMPTRAC <i>Ready!</i> unloaded panels for all SL jacks; Color: light gray (RAL 7035)	1711685-2



Flushmount Modular Patch Panel (unloaded)

FEATURES

- 19" 1U unloaded flushmount panel to be equipped with different SlimLine jacks
- Suitable for UTP and STP SL Series jacks
- Including grounding bolt

Color: black (RAL 9005)

ORDERING INFORMATION

Description	Part Number
Flushmount Modular Panel	1-1671183-1



Flushmount Standard Patch Panels (unloaded)

FEATURES

- 19" Standard unloaded flushmount panel to be equipped with different SlimLine jacks
- Accepts up to 24 SL jacks
- Including grounding bolt

ORDERING INFORMATION

Description	Part Number
24 port panel; Height: 1U; Color: black (RAL 9005)	336526-1
24 port panel; Height: 1U; Color: light gray (RAL 7035)	336526-4



Modular Twisted Pair

Unloaded Hardware - Patch Panels

Modular Q-Jack Patch Panel (unloaded)

FEATURES

- 19" unloaded 1U flushmount patch panel to be used with Q-Jacks (see page 268)
- UTP and STP configuration possible
- Integral cable management bar
- 45° IDC contacts providing secure, gas-tight connections
- Accepts 110 style termination tools
- Universal 568A/B wiring
- Discrete labelling system



ORDERING INFORMATION

Description	Part Number
24 port Q-Jack Patch Panel (unloaded)	300001739943
48 port Q-Jack Patch Panel (unloaded)	300001739995
Blank plugs 12 per pack	300001741753

Modular KM8 Jack Patch Panel (unloaded)

FEATURES

- 19" unloaded 1U flushmount patch panel to be used with KM8 Jacks (see pages 267, 272 and 274)
- UTP and STP configuration possible
- Integral cable management bar
- KM8 termination tool
- Discrete labelling system



ORDERING INFORMATION

Description	Part Number
24 port KM8 Patch Panel (unloaded)	7022 2 155-24
32 port KM8 Patch Panel (unloaded)	7022 2 155-32

Modular Twisted Pair

Unloaded Hardware - Consolidation Box

Quick-Fit Consolidation Point Box

FEATURES

- Wall mount or raised floor use
- Hinged cover with knurled screw
- Low profile (H = 56mm)
- High flexibility, accepts copper and fiber Quick-Fit modules and/or cassettes
- Installer friendly
- Dust resistant
- Easy access for cleaning fiber optic connectors
- Robust construction
- Integrated strain relief feature
- Including grounding bolt

Color: Black (RAL 9005)



ORDERING INFORMATION

Description	Part Number
Quick-Fit Consolidation Point Box	1-1671414-1

Unloaded Copper Quick-Fit Modules

- To be equipped with six SL Jacks
- Available for STP and UTP
- Automatic bonding by design
- Labels included



ORDERING INFORMATION

Description	Part Number
STP Quick-Fit module	2111093-1
UTP Quick-Fit module	2111117-1
Blank Quick-Fit module	1479698-1



Modular Twisted Pair

Unloaded Hardware - Mini-Pods

MiniPods

FEATURES

- External mounting points
- Can be passed through standard floor grommets
- Incorporated dust protection on each port
- 3, 4 and 6 port versions available
- Unloaded version for AMP-TWIST jacks (STP & UTP) and SL Series 110C Jacks



ORDERING INFORMATION

Description	Part Number
MiniPod Unloaded 3 port w/angled adaptor for AMP-TWIST & SL jacks	2153216-3
MiniPod Unloaded 4 port w/angled adaptor for AMP-TWIST & SL jacks	2153216-4
MiniPod Unloaded 6 port w/angled adaptor for AMP-TWIST & SL jacks	2153216-6

Modular Twisted Pair

Unloaded Hardware - Outlets 80 x 80 mm (DIN)

DIN Flushmount 3 Port Angled Outlet

FEATURES

- 3 port outlet to accept up to 3 SL Series Jacks
- Compatible with standard and designer 50 x 50 faceplates and 80 x 80 frames
- Ports are iconable Links to labeling in by name



ORDERING INFORMATION

Description	Part Number
DIN flushmount 3 port angled outlet (incl. 50 x 50 faceplate); Color: almond (RAL 1013)	1711485-1
DIN flushmount 3 port angled outlet (incl. 50 x 50 faceplate); Color: pure white (RAL 9010)	1711485-2
DIN flushmount 3 port angled outlet UP0 (mounting frame only)	1711490-1
DIN flushmount 3 port angled outlet (incl. 50 x 50 faceplate & 80 x 80 frame); Color: almond (RAL 1013)	1711537-1
DIN flushmount 3 port angled outlet (incl. 50 x 50 faceplate & 80 x 80 frame); Color: pure white (RAL 9010)	1711537-2

DIN 3 Port Angled Outlet

FEATURES

- 3 Port outlet to accept up to 3 SL Series Jacks
- 50 x 50 mm footprint
- Supplied complete with 2 removable / replaceable blanking plates



ORDERING INFORMATION

Description	Part Number
50 x 50 mm DIN 3 port angled outlet without plastic frame; Color: almond (RAL 1013)	336613-1
50 x 50 mm DIN 3 port angled outlet without plastic frame; Color: pure white (RAL 9010)	2-336613-1
50 x 50 mm DIN 3 port angled outlet with 80 x 80 mm plastic frame; Color: almond (RAL 1013)	336614-1
50 x 50 mm DIN 3 port angled outlet with 80 x 80 mm plastic frame; Color: pure white (RAL 9010)	2-336614-1

Modular Twisted Pair

Unloaded Hardware - Outlets 80 x 80 mm (DIN)

DIN Dual Angled Outlet

FEATURES

- Dual outlet to accept either up to 2 SL Series Jacks
- To be used with single or multiple gang DIN faceplates
- Supplied complete with back plate, adapter plate and shutters
- Individual ports are icon-able



ORDERING INFORMATION

Description	Part Number
DIN Dual Angled Outlet, for 2x Slim Line Jack; Color: almond (RAL 1013)	966936-5
DIN Dual Angled Outlet, for 2x Slim Line Jack; Color: pure white (RAL 9010)	2-966936-5

DIN Standard Outlet for Recessed Mounting

FEATURES

- Outlet for recessed mounting
- To be used with single or multiple gang DIN faceplates
- Supplied complete with spring loaded shutter

ORDERING INFORMATION

Description	Part Number
DIN standard outlet; almond (RAL 1013)	966223-1
DIN standard outlet; pure white (RAL 9010)	2-966223-1
DIN dual straight outlet; almond (RAL 1013)	966224-1
DIN dual straight outlet; pure white (RAL 9010)	2-966224-1

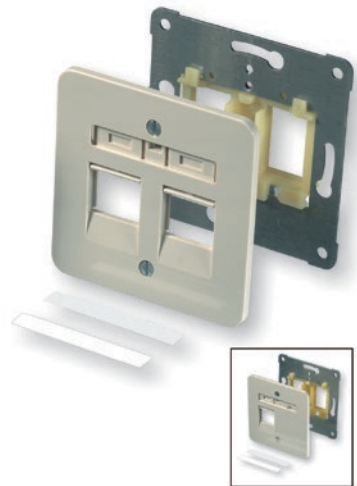

European Keystone Faceplate for HK and KM8

FEATURES

- Two port faceplate, 50x50
- For use with Cat5e HK and Cat6 KM8 jacks
- Complete with integrated dust protection
- Removable corners for installation in areas with restricted space



ORDERING INFORMATION

Description	Part Number
Unloaded Keystone Faceplate, 50x50, White	6690 2 675-01
Faceplate, 80x80, White	6690 3 725-05

Note: Unloaded faceplates compatible with HK jacks:

Cat 5e HK UTP Pure White (6540 1 130-01)

Cat 5e HK UTP Black (6540 1 130-04)

Cat 5e HK STP Metal (6540 1 154-02)

Modular Twisted Pair

Unloaded Hardware - Outlets 80 x 80 mm (DIN)

DIN 50 x 50 mm Faceplate Frame

FEATURES

- Faceplate suitable for all outlets with a 50 x 50 mm footprint
- External Dimensions 80 x 80 mm

ORDERING INFORMATION

Description	Part Number
80 x 80 mm Faceplate Frame for 50 x 50 mm outlets; pure white (RAL 9010)	5-336608-1
80 x 80 mm Faceplate Frame for 50 x 50 mm outlets; Color: almond (RAL 1013)	5-336608-2
80 x 80 mm Faceplate Frame for 50 x 50 mm outlets; Color: black (RAL 9005)	5-336608-3



Single and Multiple DIN Faceplate Frames

FEATURES

- Faceplate for suitable for all outlets with a 75 x 75 mm footprint
- External Dimensions 80 x 80 mm

ORDERING INFORMATION

Description	Part Number
Single Faceplate Frame; almond (RAL 1013)	964830-1
Single Faceplate Frame; pure white (RAL 9010)	2-964830-1
Dual Faceplate Frame; almond (RAL 1013)	964361-2
Dual Faceplate Frame; pure white (RAL 9010)	2-964361-2
Triple Faceplate Frame; almond (RAL 1013)	964361-3
Triple Faceplate Frame; pure white (RAL 9010)	2-964361-3



DIN Surface Mount Outlet Back Box

FEATURES

- Back Box for Surface Mounting
- Available individually or as a complete kit with a single faceplate
- Not suitable for use with multiple faceplates

ORDERING INFORMATION

Description	Part Number
Surface Mount Outlet Back Box; almond (RAL 1013); Back box only	966740-1
Surface Mount Outlet Back Box; almond (RAL 1013); Back box + faceplate	966740-2
Surface Mount Outlet Back Box; pure white (RAL 9010); Back box only	2-966740-1
Surface Mount Outlet Back Box; pure white (RAL 9010); Back box + faceplate	2-966740-2
Adaptor DIN RAIL to DIN Surface Mount Outlet Back Box;	1671164-1

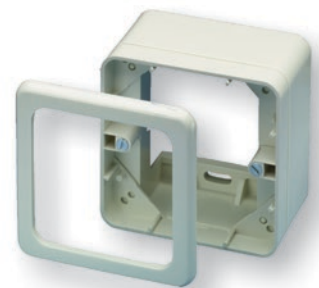

Modular Twisted Pair

Unloaded Hardware - Outlets 80 x 80 mm (DIN)

Universal Mounting Bracket

FEATURES

- Universal Mounting Bracket for installations into trunking
- Available in two sizes:
 - for installation into trunking with a small "C-Profile"
 - for installation into trunking with a big "C-Profile"

ORDERING INFORMATION

Description	Part Number
Universal Mounting Bracket for small C-profile	966498-1
Universal mounting bracket for big C-profile	1671925-1

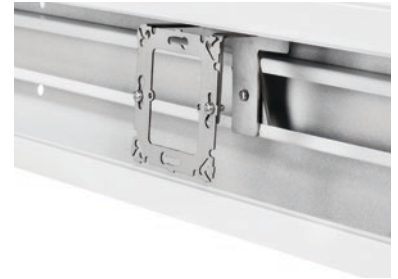

Modular Twisted Pair

Unloaded Hardware - Outlets 80 x 80 mm (DIN)

Floor box Bracket for OBO Bettermann GESR 7/10

FEATURES

- Mounting Bracket for installations into Ackerman floor boxes
- Supplied complete with fixing screws
- Stainless Steel bracket
- Complete with strain relief handle
- 2 lengths available - with or without cable management
- Blanking Plate available separately



ORDERING INFORMATION

Description	Part Number
Blanking Plate (Pearl white)	964719-1
Floor box Bracket; 3 Gang without Management	1394294-1
Floor box Bracket; 2 Gang without Management	1394294-3

SL Jack Mounting Frame for Bettermann Floor Boxes

FEATURES

- High density SL applications in floor box environments
- Angled geometry for easy cable management
- Frame is iconable and provides labeling space
- May be modified to suit almost any floor box application
- SL Jacks with dust covers recommended for use within these frames
- Patent pending
- Available unpainted or in black
- Unpainted parts are equipped with VDE grounding bolt



Color: black

ORDERING INFORMATION

Description	Part Number
SL Jack mounting frame; 6 Ports black (short version)	1711255-1
SL Jack mounting frame; 9 Ports black (long version)	1711255-2
SL Jack mounting frame; 6 Ports unpainted (short version)	1711255-3
SL Jack mounting frame; 9 Ports unpainted (long version)	1711255-4

Modular Twisted Pair

Unloaded Hardware - Outlets Swiss Installation

“EDIZIOdue” 2 Port Straight

FEATURES

- “EDIZIOdue” 2 port faceplates suitable for trunking, recessed or surface mounting
- Accepts all SL Series Jacks
- Individual ports are icon-able



ORDERING INFORMATION

Description	Part Number
AP; Color: pure white (RAL 9010)	5-101016-7
UP; Color: pure white (RAL 9010)	1711168-1
UP; Color: black (RAL 9005)	1711168-4
KNL; Color: pure white (RAL 9010)	1711169-1
KNL; Color: black (RAL 9005)	1711169-4

Kallysto 2 Port Angled with Adaptor Plate

FEATURES

- Kallysto 2 port angled faceplate suitable for trunking, recessed or surfaced mounting
- Accepts all SL Series Jacks
- Large labeling field



ORDERING INFORMATION

Description	Part Number
UP; Color: pure white (RAL 9010)	1711604-1
UP; Color: black (RAL 9005)	1711604-4
KNL; Color: pure white (RAL 9010)	1711632-1
KNL; Color: black (RAL 9005)	1711632-4
AP; Color: pure white (RAL 9010)	1711633-1
AP; Color: black (RAL 9005)	1711633-4

“FLF” 2 Port with Adaptor Plate

FEATURES

- Dual faceplate suitable for floor box mounting
- Accepts all SL Series Jacks

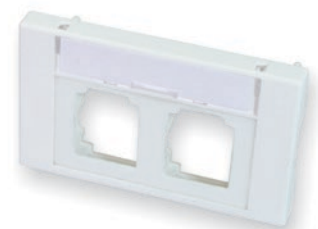

ORDERING INFORMATION

Description	Part Number
FLF; Color: pure white	1711606-1
FLF; Color: black	1711606-2

Modular Twisted Pair

Unloaded Hardware - Outlets Swiss Installation

“EDIZIOdue Compatible” 3 Port DIN Flushmount Angled

FEATURES

- “EDIZIOdue compatible” 3 port angled faceplates suitable for trunking or recessed mounting
- Accepts all SL Series Jacks (except AMP-TWIST 7_AS)
- Self-adhesive labels are available
- Individual ports are icon-able

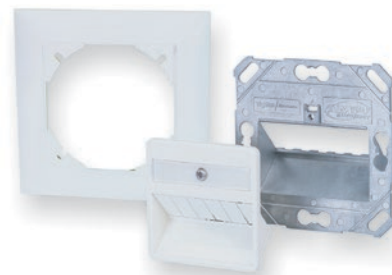

ORDERING INFORMATION

Description	Part Number
UP, 3 port; Color: pure white (RAL 9010)	1711625-1
KNL, 3 port; Color: pure white (RAL 9010)	1711626-1

“EDIZIOdue Compatible” 3 Port DIN Angled

FEATURES

- “EDIZIOdue compatible” 3 port DIN angled faceplates suitable for trunking or recessed mounting
- Accepts all SL Series Jacks
- Self-adhesive labels are available
- Individual ports are icon-able



ORDERING INFORMATION

Description	Part Number
UP, 3 port; Color: pure white (RAL 9010)	1711082-1
KNL, 3 port; Color: pure white (RAL 9010)	1711083-1

“EDIZIOdue Compatible” 4 Port Straight

FEATURES

- “EDIZIOdue compatible” 4 port straight faceplates
- Accepts all SL Series Jacks
- Self-adhesive labels are available
- Individual ports are icon-able



ORDERING INFORMATION

Description	Part Number
KNL, 4 Port; Color: pure white	1711282-1
KNL, 4 port; Color: black	1711282-2

Modular Twisted Pair

Unloaded Hardware - Outlets Swiss Installation

“Standard” 2 Port Straight

FEATURES

- “Standard” Style 2 port faceplates suitable for trunking or recessed mounting
- Accepts all SL Series Jacks
- Individual ports are icon-able



ORDERING INFORMATION

Description	Part Number
UP; Color: pure white (RAL 9010)	7-101016-3
KNL; Color: pure white (RAL 9010)	7-101016-5

Basico 2 Port Angled with Adaptor Plate

FEATURES

- Basico 2 port angled faceplates suitable for trunking, recessed or surface mounting
- Accepts all SL series jacks
- Large labeling field



ORDERING INFORMATION

Description	Part Number
UP; Color: pure white (RAL 9010)	1711605-1
AP; Color: pure white (RAL 9010)	1711634-1
KNL; Color: pure white (RAL 9010)	1711644-1

Blanking plate

FEATURES

- Blanking plate to be inserted from frontside



ORDERING INFORMATION

Description	Part Number
Blanking Plate for EDIZIOdue 2port + 4port and Standard Outlets; Color: pure white	1711283-1
Blanking Plate for EDIZIOdue 2port + 4port and Standard Outlets; Color: black	1711283-2
Blanking Plate for Kallysto, Basico and FLF; Color: pure white	1711937-1
Blanking Plate for Kallysto, Basico and FLF; Color: black	1711937-2

Modular Twisted Pair

Unloaded Hardware - Outlets UK Style (BS)

BS 50 mm Unloaded Faceplates and Shuttered Modules

FEATURES

- Unloaded faceplate accepts either 2 or 4 BS 50 mm shuttered modules
- Single shuttered 50 mm module (spring loaded shutter)
- Dimensions module: 25 x 50 mm

Color: signal white (RAL 9003)



ORDERING INFORMATION

Description	Part Number
Single shuttered 25 x 50 mm angled module	1711275-1
Single gang faceplate (for 2 shuttered modules)	1711399-1
Dual gang faceplates (for 4 shuttered modules)	1711400-1
Triple gang faceplate (for 3 shuttered modules)	1711963-1
Blanking plate 25 x 50 mm	1711403-1
Blanking plate 12.5 x 50 mm	1711404-1

UK Style Faceplates & Adaptors

FEATURES

- For use with CL keystone jacks
- In-line and angled options available
- Single and Double gang faceplates



ORDERING INFORMATION

Description	Part Number
RJ-K CL Standard 25x50 adaptor white (pack of 20)	6540 1 801-00
RJ-K CL Angled 25x50 adaptor white (pack of 20)	6540 1 802-00
Keystone Angled 25x50 adaptor white (pack of 1)	6538 4 111-05
Unloaded Deep Faceplate, UK style, 50x50 (single-gang), White (Pack of 10)	6540 1 812-04
Unloaded Deep Faceplate, UK style, 50x100 (double-gang), White (Pack of 10)	6540 1 812-05

Note: Unloaded adaptors compatible with jacks:
 Cat 5e CL UTP White shutter RJ45 (6540 1 200-01)
 Cat 6 CL UTP White RJ45 (6537 1 010-00)

Modular Twisted Pair

Unloaded Hardware - Outlets UK Style (BS)

BS LJ6C Unloaded Faceplates and Shuttered Modules

FEATURES

- Unloaded faceplate accepts either 1 or 2 LJ6C shuttered modules
- Dimensions faceplate: 86 x 86 mm (single and dual port)
- Single shuttered LJ6C module (spring loaded shutter)
- Dimensions module 25 x 39 mm

Color: signal white (RAL 9003)



ORDERING INFORMATION

Description	Part Number
Single port LJ6C unloaded faceplate	1711301-1
Dual port LJ6C unloaded faceplate	1711302-1
Quad port LJ6C unloaded faceplate	2153004-1
Single shuttered LJ6C module	1711348-1
Blanking plate	1711491-1
Single unshuttered angled LJ6C module	1711775-1
Single shuttered angled LJ6C module	1859096-1



LJ6C UK Style Faceplates & Adaptors

FEATURES

- Adaptors for use with CL keystone jacks
- In-line and angled options available

ORDERING INFORMATION

Description	Part Number
CL Standard LJ6C Adaptor (pack of 20)	6540 1 810-00
CL Angled LJ6C Adaptor (pack of 20)	6540 1 813-00
Keystone Standard LJ6C Adaptor (pack of 1)	6830 2 402-00
Keystone Angled LJ6C Adaptor (pack of 1)	6540 1 814-01

Note: Unloaded adaptors compatible with jacks:
Cat 5e CL UTP White shutter RJ45 (6540 1 200-01)
Cat 6 CL UTP White RJ45 (6537 1 010-00)



Modular Twisted Pair

Unloaded Hardware - Outlets UK Style (BS)

Keystone UK Style Faceplate

FEATURES

- UK style faceplate with integrated dust protection
- For accommodating Category 5e HK and Category 6 KM8 and keystone jacks
- Dimensions: 85 x 85mm



ORDERING INFORMATION

Description	Part Number
Unloaded Faceplate, Keystone, UK Style, White, Single	6538 3 111-03
Unloaded Faceplate, Keystone, UK Style, White, Double	6538 3 111-04

Note: Unloaded faceplates compatible with HK jacks:
Cat 5e HK UTP Pure White (6540 1 130-01)
Cat 5e HK UTP Black (6540 1 130-04)
Cat 5e HK STP Metal (6540 1 154-02)

Back Boxes for UK Style Outlets

FEATURES

- Designed for surface installations
- Dimensions: 86 x 86 x 27mm



ORDERING INFORMATION

Description	Part Number
Back Box, Single Gang White	6536 1 005-00
Back Box, Double Gang White	6536 3 044-00

Modular Twisted Pair

Unloaded Hardware - Outlets 45 x 45 mm ("Mosaic")

Single and Dual Outlets 45 x 45 mm in Angled and Flat versions

FEATURES

- Unloaded Single Port half width shuttered module (spring loaded) with 22.5 x 45 mm footprint
- Unloaded Dual and Single Port full width shuttered module (spring loaded) with 45 x 45 mm footprint
- Frame outer dimension 86 x 86 mm
- Frame mounting dimension 60 mm

Color: pure white (RAL 9010)

ORDERING INFORMATION

Description	Part Number
Dual/Single Port angled outlet for 2 SL jacks or 1 AMP-TWIST Jack; Size: 45 x 45 mm; Picture: A	336793-1
Dual Port shuttered angled outlet for 2 AMP-TWIST Jacks; Size: 45 x 45 mm; Picture: B	1711797-1
Single Port shuttered angled outlet for 1 SL jack or 1 AMP-TWIST Jack; Size: 22.5 x 45 mm; Picture: C	1711664-1
Single Port shuttered angled outlet for 2 AMP-TWIST Jacks; Size: 45 x 45 mm;	1711653-1
Single Port shuttered flat outlet for 1 SL jack or 1 AMP-TWIST Jack; Size: 22.5 x 45 mm, Picture: D	1711349-1
Single Port shuttered flat outlet for 1 SL jack or 1 AMP-TWIST Jack; Size: 45 x 45 mm; Picture: E	1711277-1
Dual Port shuttered flat outlet 2 SL jacks; Size: 45 x 45 mm	1711276-1
"45x45" Outlet 45 x 45 mm for SC-Duplex, ST-Style, SL adaptor or MT-RJ jack; Picture: F	183931-1
Frame for 1x 45 x45 module or 2x 22.5x45 modules; Size: 45 x 45 mm; Picture: G	1-1711307-1
Blind cover; Size: 22.5 x 45 mm	1711306-1
Adapter Frame to 50 x 50 mm; Color: almond (RAL 1013); Picture: H	1379156-1
Adapter Frame 50 x 50 mm to Legrand Valena™ frames	1859130-1
85 x 85 Surface mount box; accepts frame 1-1711307-1; 45 mm deep	185705-1



Modular Twisted Pair

Unloaded Hardware - Outlets 45 x 45 mm ("Mosaic")

45x45 Adaptors and Faceplate

FEATURES

- For use with Category 5e HK and Category 6 RJ45 Keystone jacks
- Adaptors come complete with integrated dust protection

ORDERING INFORMATION

Description	Part Number
Adaptor 22,5x45mm, Single, White	6690 1 825-10
Adaptor 45x45mm, Single,White	6690 1 825-00
Unloaded Faceplate,45x45mm, White	6690 3 745-01

Note: Unloaded adaptors compatible with HK jacks:
Cat 5e HK UTP Pure White (6540 1 130-01)
Cat 5e HK UTP Black (6540 1 130-04)
Cat 5e HK STP Metal (6540 1 154-02)



Modular Twisted Pair

Unloaded Hardware - Outlets Single/Double Gang (US Installation)

Standard USA Faceplates

FEATURES

- Accepts all AMP-TWIST jacks, SL Series jacks, MT-RJ outlet jacks and SL Series inserts
- Faceplate dimensions:
2.75 in (69.85 mm) x 4.5 in (114.30 mm) x 0.22 in (5.59 mm)
- Label viewing area with
integrated label covers that flip down and Snap-in place
- Extender kits are used to add 0.5 inches of space between the mounting surface and the faceplate

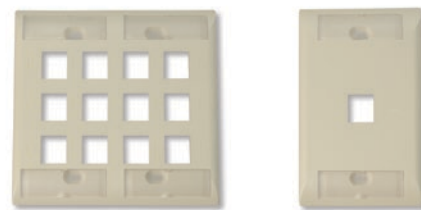

ORDERING INFORMATION

Description	Part Number
Port Count: 1; Single Gang; Orientation: Vertical	2111008-1
Port Count: 2; Single Gang; Orientation: Vertical	2111009-1
Port Count: 3; Single Gang; Orientation: Vertical	2111010-1
Port Count: 4; Single Gang; Orientation: Vertical	2111011-1
Port Count: 6; Single Gang; Orientation: Vertical	2111012-1
Port Count: 6; Double Gang; Orientation: Vertical	2111013-1
Port Count: 8; Double Gang; Orientation: Vertical	2111014-1
Port Count: 12; Double Gang; Orientation: Vertical	2111015-1
Extender Kit	2111201-1
Port Count: 4; Single Gang; Orientation: Horizontal	2111203-1

Y- -X	Color
0- -1	Almond
0- -2	Black
0- -3	White
0- -4	Gray
1- -1	Electrical Ivory

Surface Boxes

FEATURES

- Back Box for Surface Mounting
- 44.5 mm depth and one piece construction simplifies installation

ORDERING INFORMATION

Description	Part Number
Single Gang; almond	558251-1
Single Gang; pure white	558251-3



Modular Twisted Pair

Unloaded Hardware - Surface Mount Boxes

Surface Mount Modules and Accessories

FEATURES

- Accept AMP-TWIST modular jacks and all SL Series modular jacks and inserts
- Can accommodate fiber cable and connectors (MT-RJ, LC, simplex SC, and ST) and includes fiber loop management
- Allows access to jacks and inserts while module is mounted
- Cable exits located on rear, bottom and both sides of modules Features cable entry strain relief
- Provided with label and clear label cover, squares of double-sided foam tape, self-tapping screws, and cable ties

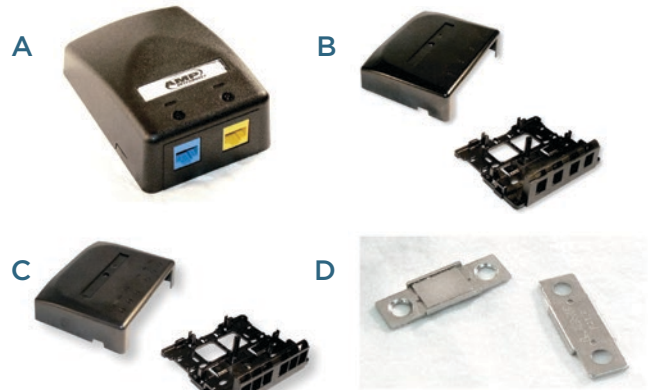

Y- -X	Color
0- -1	Almond
0- -2	Black
0- -3	White
0- -4	Gray
1- -1	Electrical Ivory

ORDERING INFORMATION

Description	Part Number
Surface Mount Module; 2-Port; Figure A	Y-1933668-X
Surface Mount Module; 4-Port; Figure B	Y-1933671-X
Surface Mount Module; 6-Port; Figure C	Y-1933674-X
Magnet for Metal Surface Mounting; Figure D	1933677-1

Modular Jack Boxes

FEATURES

- Accepts unshielded Standard 110Connect, any SL Series Jacks and MT-RJ
- Very compact
- Individual outlets are icon-able
- Patented invisible icon holes remain invisible when not used

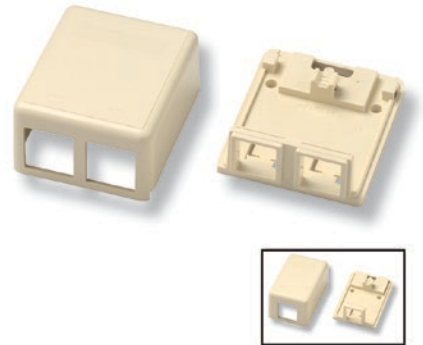

ORDERING INFORMATION

Description	Part Number
1 Port; almond	1-1116697-1
1 Port; pure white	1-1116697-3
2 Port; almond	1-1116698-1
2 Port; pure white	1-1116698-3

Modular Twisted Pair

Unloaded Hardware - Surface Mount Boxes

AMP-TWIST SL Jack Office Boxes

FEATURES

- Accepts AMP-TWIST jacks and all SL series jacks
- Compatible with most trunking
- High density
- Individual outlets are icon-able
- Patented invisible icon holes remain invisible when not used



ORDERING INFORMATION

Description	Part Number
2 Port; Color: almond	1933287-1
2 Port; Color: black	1933287-2
2 Port; Color: pure white	1933287-3
4 Port; Color: almond	1933288-1
4 Port; Color: black	1933288-2
4 Port; Color: pure white	1933288-3

Surface Mount Boxes

FEATURES

- Dimensions enable it to be used in restricted spaces
- Flammability class: UL94 V0



ORDERING INFORMATION

Description	Part Number
Surface Mount, unloaded for KM8, 1port	7080 2 064-10
Surface Mount, unloaded for KM8, 2port	7080 2 065-10



RJ-45 Dust Cap

FEATURES

- Re-usable rubber dust caps
- Fits in all RJ 45 Jacks
- Available in 7 colors



ORDERING INFORMATION

Description	Part Number
RJ-45 dust cap	Y-969556-X

Y- -X	Color
0- -1	Red
0- -2	Yellow
0- -3	Green
0- -4	Blue
0- -5	Black
0- -6	Gray
0- -7	White

Modular Twisted Pair

Twisted Pair Tools

AMP-TWIST & SL Series Modular Jack Termination Tool Kit

FEATURES

- Terminates all AMP-TWIST and SL Series Modular Jacks
- Strips cable, marks foil, terminates and cuts 8 conductors at once
- Maintains twisted pair integrity
- Reliable connections every time
- Time and cost saving simplifying lacing process and speeding up the termination
- Lacing fixture assures simple and efficient use (not used for AMP-TWIST Jacks)



ORDERING INFORMATION

Description	Part Number
Handheld termination tool kit with lacing fixture	1725150-1
Handheld termination tool kit without lacing fixture (for AMP-TWIST jacks)	1725150-3
Lacing fixture - Spare Part	1673956-1

110C Impact Tools

FEATURES

- Industry standard termination tools for SL Modular, 110Connect, AMP CO Ultra and other LSA-PLUS compatible IDC blocks
- Available as impact tool (premium or standard version) or as non-impact tool
- Tools are delivered with blade
- Extended-life blades have a lifetime three times longer than standard blades

ORDERING INFORMATION

Description	Part Number
Premium Impact Tool with Extended-Life Blade	1375308-1
Standard Impact Tool with Standard Blade	1583608-1
Non-Impact Tool with Standard Blade	1583236-1
Replacement Blade (Extended-Life)	1375309-1
Replacement Blade (Standard)	1375310-1



Modular Twisted Pair

Twisted Pair Tools

Cable Preparation Tools

FEATURES

- Easy, safe and fast cable preparation
- Diagonal Cutter for precise cutting of wire
- JackKnack cuts the cable sheath
- LightKnack is designed to provide light anywhere



ORDERING INFORMATION

Description	Part Number
Diagonal Cutter	1116571-1
JackKnack	2119000-1
LightKnack	2119700-1



Q-Jack Punchdown Pad

FEATURES

- Q-Jack Punchdown Pad helps the termination process
- Q-Jack Punchdown Pad also support RJ45 UTP Modular Jacks

ORDERING INFORMATION

Description	Part Number
Q-Jack Punchdown Pad (Pack of 10)	6537 1 610-00



LSA-PLUS Insertion Tool

FEATURES

- For termination of wires with the conductor diameter range 0.35 - 0.9mm and overall diameter range 0.7 - 2.6mm
- Insert and cut wires simultaneously
- Insertion sensor ensures the conductor is fully inserted into the block contacts before allowing any excess wire to be cut off
- An inhibitor lock prevents the scissors from operating, particularly useful in applications in which conductors are daisy-chained through several contacts
- Specially designed wire hook removes terminated conductors
- Blade helps to remove blocks easily from back mount frames



ORDERING INFORMATION

Description	Part Number
LSA-PLUS Insertion Tool	6417 2 055-01

Modular Twisted Pair

Twisted Pair Tools

KM8 Termination Tool

FEATURES

- Tool for swift terminating KM8 style jacks
- Hundreds of KM8 jack terminations from one tool



ORDERING INFORMATION

Description	Part Number
KM8 Termination Tool	6830 1 490-00

Multimate termination Tool

FEATURES

- Terminates RJ45 UTP Modular Jack ensuring a significant saving of installation time
- Inserts and crops wire simultaneously in one single handed easy action
- Replacement blade units can be purchased and replaced without the need for special tooling
- Carry pouch with belt loop helps conveniently store and protect the tool and its contents



ORDERING INFORMATION

Description	Part Number
Multimate Termination Tool Pack	6467 1 140-00
Replacement Head, C6A Keystone (White)	6467 2 142-00
Replacement Blade Unit	6467 2 149-00

13. Home Networks Residential Cabling

Enclosures & Panels.....	290
Modules.....	291
Connectivity.....	292
Accessories.....	294

Home Net-Works Residential Cabling

Enclosures & Panels

Home Net-Works Enclosures Surface Mount

FEATURES

- Aesthetic surface mount enclosure
- Solid steel construction with hingeable cover
- Knockout ports for cable entry on top and bottom
- 1" x 1" mounting grid for maximum versatility
- Accommodates multiple 18-Port connectivity panels
- Including grounding bolt



ORDERING INFORMATION

Description	Color	Part Number
Home Net-Works Enclosure Small	White (RAL 9003)	1-1671331-1
Home Net-Works Enclosure Large	White (RAL 9003)	1-1671331-2

Home Net-Works Enclosures Flush Mount

FEATURES

- Aesthetic flush mount enclosure with cover (all AWG 20 steel)
- Multiple double knockouts for cable entry on all surfaces
- Multiple cable tie tabs for cable management
- 1" x 1" mounting grid for maximum versatility
- Recess or surface option
- Dual knockouts for electrical j-box
- Accommodates multiple 18-Port connectivity panels

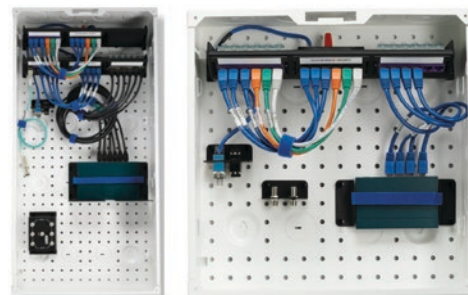

ORDERING INFORMATION

Description	Color	Part Number
14" Enclosure with Cover	White	1933691-1
28" Enclosure with Cover	White	1933692-1

Connectivity Panels

FEATURES

- Inclined panel accepting up to 3 x 6-port modules
- Available for UTP and STP
- STP version including a PEC and grounding point

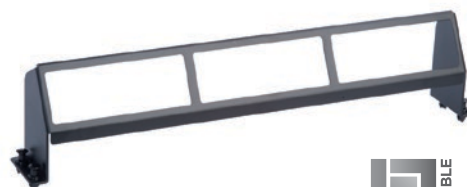

ORDERING INFORMATION

Description	Color	Part Number
Angled Bracket STP	Black (RAL 9005)	1933776-1
Angled Bracket UTP	Black (RAL 9005)	1933693-1

Home Net-Works Residential Cabling

Modules

AMP CO Ultra Quick-Fit Kit

FEATURES

- Fast termination and easy assembly
- Shielded housing with patented automatic shielding clamp
- Kit includes 2 die-cast housings, 2 AMP CO Plus Edge Connectors and frame for labeling. (AMP CO Inserts to be ordered separately)
- Performance up to 2.0 GHz



ORDERING INFORMATION

Description	Color	Part Number
AMP CO Ultra Quick-Fit Kit; (RAL 9005)	Black	2153014-1

Standard Telecom Bridge

FEATURES

- 6 Ports - 4 lines per port
- For basic telephone, fax and dial-op modem service
- Bridge for incoming lines to six output ports

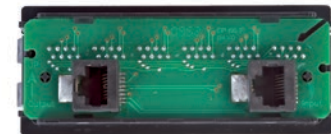

ORDERING INFORMATION

Description	Part Number
Front-Loadable Standard Telecom Bridge	1479701-1

Unloaded Connectivity Module

FEATURES

- 6 port module, accepts all SL series jacks
- Available for UTP and STP



ORDERING INFORMATION

Description	Part Number
Connectivity Module STP	2111093-1
Connectivity Module UTP	2111117-1
Blank module	1479698-1

Home Net-Works Residential Cabling

Connectivity

SL Series Multimedia Inserts

FEATURES

- The inserts offer flexibility and density at the work area outlet
- Can be installed in any faceplate or outlet designed to the SL series jack footprint
- Some couplers may not be available in all colors

Y- -X	Color
0- -1	Light Almond
0- -2	Black
1- -3	Alpine White

ORDERING INFORMATION

Description	Part Number
ST Coupler; Fiber Type: Multimode	Y-1339123-X
ST Coupler; Fiber Type: Singlemode	Y-1479181-X
BNC Coupler Insert; Figure B	Y-2111615-X
MT-RJ SL Series Housing	Y-1374416-X
RCA Coupler, Red Dielectric	Y-1375361-X
RCA Coupler, White Dielectric	Y-1375362-X
RCA Coupler, Yellow Dielectric	Y-1375363-X
RCA Solder Termination, Red Dielectric	Y-1375364-X
RCA Solder Termination, White Dielectric	Y-1375365-X
RCA Solder Termination, Yellow Dielectric	Y-1375366-X
RCA Coupler, Green Dielectric	Y-1933192-X
RCA Coupler, Blue Dielectric	Y-1933193-X
RCA Coupler, Orange Dielectric	Y-1933194-X
RCA to F-Connector; Figure I	Y-1933096-X
F-Connector Coupler, 2 GHz; Figure E	Y-1499855-X
3.5 mm Stereo Mini-Headphone, Screw Terminal, Figure F	Y-1933582-X
Speaker Post, Black Stripe	Y-1479190-X
Speaker Post, Red Stripe; Figure G	Y-1479191-X
SC Simplex Coupler; Fiber Type: Multimode or Singlemode	Y-1499836-X
LC Coupler; Fiber Type: Singlemode APC; LC Coupler and Housing, Green	1933286-3
LC Coupler; Fiber Type: Singlemode; LC Coupler and Housing, Blue	1933286-4
LC Coupler; Fiber Type: XG LO 850 nm 50/125µm; LC Coupler and Housing, Aqua, OM3 & OM4	1933286-6
LC Coupler; Fiber Type: 50/125µm; LC Coupler and Housing, Black, OM2	1-1933286-1
LC Coupler; Fiber Type: 62.5/125µm; LC Coupler and Housing, Beige, OM1	1-1933286-2
USB A-A Coupler; Figure J	Y-1933659-X
USB B-A Coupler; Figure K	Y-1933661-X
HDMI Coupler Figure H	2111500-2
Blank Insert Figure A	Y-1116412-X

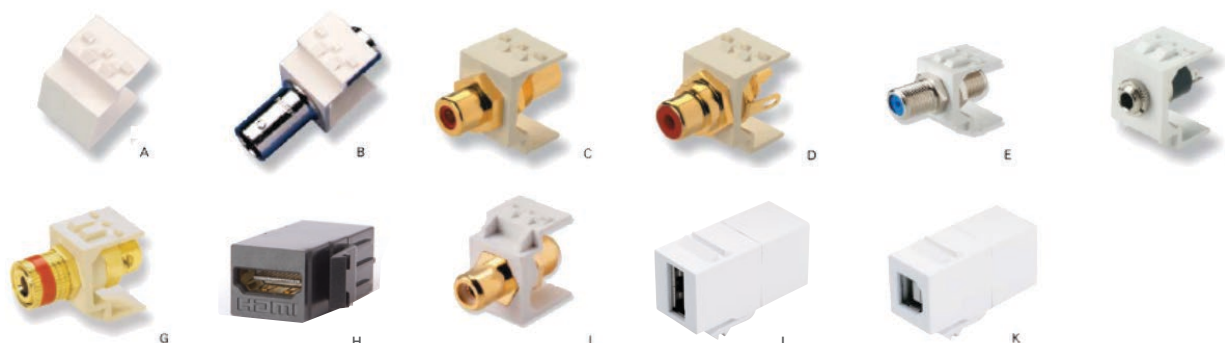

Home Net-Works Residential Cabling

Connectivity

SL Series Multimedia Jacks

FEATURES

- For use when distances are less than 130 ft.
- Uses Standard 110 Termination and will accept 26-22 AWG conductors
- RCA Multimedia Jack
 - For audio and visual signals
 - Uses one pair of twisted-pair-cable white,red or yellow dielectrics to match home theater equipment
- S-Video Multimedia Jack
 - For S-Video Y/C (Luminance/Chrominance black and white/Color) signals
 - Uses two pairs of a standard twisted-pair cable



ORDERING INFORMATION

Description	Part Number
S-Video	1375149-2
RCA to 110 Punch Down, Red Dielectric	Y-1479230-X
RCA to 110 Punch Down, White Dielectric	Y-1479231-X
RCA to 110 Punch Down, Yellow Dielectric	Y-1479232-X

Y- -X	Color
0- -1	Light Almond
1- -3	Alpine White

Home Net-Works Residential Cabling

Accessories

Hook & Loop Cable Ties

FEATURES

- Hook and loop ties
- No risk of damaging cables
- Releasable and reusable
- An order quantity of one equals one roll of 10 ties



ORDERING INFORMATION

Description	Part Number
Hook & Loop Tie 1" x 8" (10pcs.)	1375253-2
Hook & Loop Tie 1" x 12" (10pcs.)	1375254-2

Accessories

FEATURES

- Demarcation bracket: SL Series bracket accepts 2 SL Series jacks for incoming data service demarcation
- Hook & Loop Hold-Down Bracket: Used to secure network electronics such as cable/DSL routers
- Network Shelf: Accommodates network electronics such as DSL modems, routers and switches



ORDERING INFORMATION

Description	Part Number
Dual Demarcation Bracket	1479441-1
Hook & Loop Hold-Down Bracket	1479440-1
Network Shelf	1479437-1

14. Commercial and Industrial Ethernet LAN

Power-over-Ethernet	296
LAN Media Converters.....	297
Industrial Media Converters.....	299
Industrial Switches	300
SFP Transceiver.....	302

Commercial and Industrial Ethernet LAN

Power-over-Ethernet

8 Port Modular PoE Gigabit Midspan Unit

FEATURES

- 8 Port PoE Midspan Unit
- 19" rack mountable (with mounting frame)
- Universal 110/220V (50/60Hz) power supply
- Full power on every port (15.4 W)
- Up to 3 devices can be mounted into a 19", 1U mounting frame



ORDERING INFORMATION

Description	Part Number
19", mounting frame 1U for 3 Midspans units	1591185-0
8 Port PoE Midspan unit; Power Cord for Europe	1591188-2
8 Port PoE Midspan unit; Power Cord for UK/Ireland	1591188-7

Commercial and Industrial Ethernet LAN

LAN Media Converters

Ethernet Media Converter

FEATURES

- 10 Slot 19" Rack Mount Chassis System
- Supports up to 10 Media Converters
- Different Media Converter types can be mixed
- Hot-Swappable Converters
- A second power supply can be fitted
- Exceptionally reliable dual redundant power system can be Hot-Swapped
- Dimensions: 440 x 226 x 133 mm (W x D x H)
- Internal cooling fan
- Includes kit for mounting in 19" racking



ORDERING INFORMATION

Description	Part Number
10 Slot Chassis System with 1 Power Unit; Europe	1591032-2
10 Slot Chassis System with 1 Power Unit; UK/Ireland	1591032-7
Spare/Redundant AC Power Unit for Chassis	1591034-0

10/100 MBit/s Ethernet Media Converter

FEATURES

- 10/100 MBit/s RJ-45 Copper port
- Auto-MDI/MDI-X detection
- 100Base-FX fiber port
- Dimensions: 85 x 120 x 26 mm (W x D x H)



ORDERING INFORMATION

Description	Part Number
10/100M Multimode SC Media Converter; Europe	1591024-2
10/100M Multimode SC Media Converter; UK/Ireland	1591024-7
10/100M Multimode ST-Style Media Converter; Europe	1591026-2
10/100M Multimode ST-Style Media Converter; UK/Ireland	1591026-7
10/100M Singlemode - Single Fiber WDM 1550 nm Converter; Europe	1591029-2
10/100M Singlemode - Single Fiber WDM 1550 nm Converter;UK/Ireland	1591029-7
10/100M Singlemode SC Media Converter; Europe	1591030-2
10/100M Singlemode SC Media Converter; UK/Ireland	1591030-7
10/100M Singlemode - Single Fiber WDM 1310 nm Converter; Europe	1591031-2
10/100M Singlemode - Single Fiber WDM 1310 nm Converter; UK/Ireland	1591031-7

Commercial and Industrial Ethernet LAN

LAN Media Converters

Gigabit Ethernet Media Converter

FEATURES

- 10/100/1000 MBit/s RJ-45 Copper port
- Auto-MDI/MDI-X detection
- 1000Base-SX or 1000Base-LX fiber port
- Dimensions: 85 x 120 x 26 mm (W x D x H)



ORDERING INFORMATION

Description	Part Number
1000Base-SX (multimode) Media Converter; Europe	1591020-2
1000Base-SX (multimode) Media Converter; UK/Ireland	1591020-7
1000Base-LX (singlemode) Media Converter; Europe	1591022-2
1000Base-LX (singlemode) Media Converter; UK/Ireland	1591022-7

Commercial and Industrial Ethernet LAN

Industrial Media Converters

Industrial Copper-to-Fibre Media Converter

FEATURES

- Suitable for plant rooms, factory floor, oil and gas terminal rail and marine and many more harsh environments
- Provides High / low temperature range with rugged construction Compact housing, 140 x 30 x 95 mm
- IP30 protection
- Store-and-Forward Switching Architecture
- RJ-45 port support MDI/MDI-X auto-crossover
- Autonegotiation Speed, Half/Full Duplex
- Signal indicating LEDs
- Built-In Link Lose Forwarding (LLF) & Link Fault Pass-Through (LFP) Technology
- Redundant wide range power input +12 to +48 V DC
- Flexible mounting: DIN-rail and panel mounting
- Operating Temperatures -40°C up to +75 °C



ORDERING INFORMATION

Description	Part Number
10/100 Multimode Ethernet Media converter- TEC-100-MM-XE	1987152-2

Commercial and Industrial Ethernet LAN

Industrial Switches

Fast Ethernet Industrial Switches (Unmanaged)

FEATURES

- Suitable for factories, rail and road side deployment
- Compact housing, 140 x 30 x 95 mm
- IP30 protection
- Relay output
- Store-and-Forward Switching Architecture
- RJ-45 port support MDI/MDI-X
- Broadcast storm protection
- Embedded switch controller
- supports auto negotiation
- Signal indicating LEDs
- Network Cable Redundant wide range power input +12 to +48 V DC
- Flexible mounting: DIN-rail and panel mounting
- Operating Temperatures -40°C up to +75 °C



ORDERING INFORMATION

Description	Part Number
4 Port 10/100 Ethernet Switch with single MM SC Uplink Port - TES-401-MM-XE	1987033-2
5 Port 10/100 Ethernet Switch --TES-500-XE	1987031-2
8 Port 10/100 Ethernet Switch - TES 800-XE	1987032-2

Gigabit Ethernet Industrial Switches (Unmanaged)

FEATURES

- Suitable for factories, rail and road side deployment
- Compact housing, 140 x 30 x 95 mm
- IP30 protection
- Relay output
- Store-and-Forward Switching Architecture
- RJ-45 port support MDI/MDI-X
- Broadcast storm protection
- Embedded switch controller
- Supports auto negotiation
- Signal indicating LEDs
- Network Cable Redundant wide range power input +12 to +48 V DC
- Flexible mounting: DIN-rail and panel mounting
- Operating Temperatures -40°C up to +75 °C



ORDERING INFORMATION

Description	Part Number
4 Port 10/100/1000 Ethernet Switch with single SFP Uplink Port - TES-4001-SFP-XE	1987155-2
8 Port 10/100/1000 Ethernet Switch - TES 8000-XE	1987154-2

Commercial and Industrial Ethernet LAN

Industrial Switches

10/100 Managed Industrial Switches (with Gigabit Uplink)

FEATURES

- Layer 2
- Gigabit Uplink: 2 Ports RJ-45 / SFP fiber
- Combo function (SFP or Gigabit Copper)
- Robust housing, 152 x 72 x 106 mm
- IP30 protection
- Relay output
- Store-and-Forward Switching Architecture
- RJ-45 port support MDI/MDI-X
- Signal indicating LEDs



ORDERING INFORMATION

Description	Part Number
16 Port Unmanaged 10/100 Ethernet With Dual SFP Uplink Combo ports - TES 162M-GU-SFP-COMBO	1987256-2
8 Port 10/100 Ethernet Switch with Dual SFP Uplink Combo ports - TES-802M-GU-SFP-CO	1987257-2

Commercial and Industrial Ethernet LAN

SFP Transceivers

SFP (Small Form Factor Pluggable) Transceiver



ORDERING INFORMATION

Description	Part Number
SFP Transceiver SFP-100-FX-MM	1987195-1
SFP Transceiver SFP-1000-SX-MM	3-1987195-3
SFP Transceiver SFP-100-FX-SM	1591530-1
SFP Transceiver SFP-1000-LX-SM	1591313-1

15. Administration & Labeling

Icons.....	304
Printer Labels.....	305
Quick-Fit Port Labels.....	306

Administration & Labeling

Icons

Icons

FEATURES

- Icons for port identification applicable to various faceplates of 110Connect and AMP CO series
- Different colors and different symbols available



Y- X	Color
0- -1	Almond
0- -2	Red
0- -3	Green
0- -4	Blue
0- -5	Yellow
0- -6	Black
0- -7	Orange
0- -8	White
0- -9	Violet
1- -0	Gray

ORDERING INFORMATION

Description	Part Number
16 x data	Y-558198-X
16 x phone	Y-558199-X
16x neutral; available in -1, -6, -8 and 1- -0	Y-558821-X
4x neutral, 2x Cat. 5E, 2x Cat. 6 and 1x V1, V2, V3, V4, D1, D2, D3, D4	Y-1375092-X

Printer Labels for AMP CO Installation Kits

FEATURES

- Self-adhesive A4 sheets with printer labels for AMP CO Installation Kits
- Uses standard MS Excel sheet

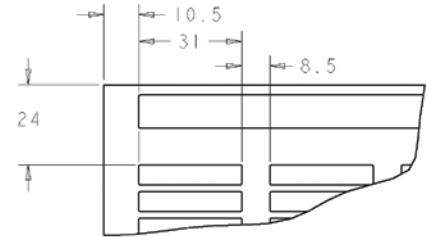

ORDERING INFORMATION

Description	Part Number
Labels (6 x 32 mm, 170 pcs per sheet); Packaging 10 sheets	969704-1

Administration & Labeling

Printer Labels

Patch Panel Labels

FEATURES

- Labels are designed to fit AMP NETCONNECT and similar patch panels
- Card stock labels are perforated and compatible with inkjet and laser printers
- Self-adhesive polyester labels are pre-cut and compatible with laser printers
- Labels are supplied on 8.5" x 11" (21,6 x 27,9 cm) sheets
- Special 0.25" (6,4 mm) high label is provided for use when icons are also desired
- For use with 110Connect and SL-style panels

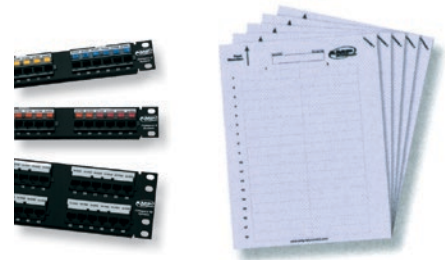

ORDERING INFORMATION

Description	Part Number
Self-adhesive Polyester; Label Size (w x h): 3.10" x 0.50" (7.9 x 1.3 cm); Labels per Sheet: 36; Standard Package: 5 sheets (180 labels)	1375352-1
Self-adhesive Polyester (also for use with 110Connect Office Box, 2 Port und 4 Port); Label Size (w x h): 3.30" x 0.25" (8.4 x 0.6 cm); Labels per Sheet: 72; 5 Sheets (360 labels)	1375353-1

Labels for Cable and Cable-Assemblies

FEATURES

- Labels are designed for use on cable and cable assemblies
- Labels are pre-cut and compatible with laser printers



ORDERING INFORMATION

Description	Part Number
4-Pair Cable; Label size (w x h): 0.984" x 1.496" (2.5 x 3.8 cm); Labels per Sheet: 48; Standard Package: 5 sheets (240 labels)	1479002-1
Self-adhesive Polyester 25-Pair Cable; Label size (w x h): 0.984" x 2.480" (2.5 x 6.3 cm); Labels per Sheet: 24; Standard Package: 5 sheets (120 labels)	1479003-1

Administration & Labeling

Quick-Fit Port Labels

Port ID labels for Quick-Fit modules and cassettes

FEATURES

- Number identification of ports
- MOQ = 100 pcs



ORDERING INFORMATION

Description	Part number
Port ID label 1...6	1933140-1
Port ID label 7...12	1933140-2
Port ID label 13...18	1933140-3
Port ID label 19...24	1933140-4
Port ID label 1/2...11/12	1671415-1
Port ID label 13/14...23/24	1671415-2
Port ID label 25/26...35/36	1671415-3
Port ID label 37/38...47/48	1671415-4
Port ID label MRJ21 XG, 1-4	2153093-1
Port ID label MRJ21 XG, 5-8	2153093-2
Port ID label MRJ21 XG, 9-12	2153093-3
Port ID label MRJ21 XG, 13-16	2153093-4
Port ID label MRJ21 XG, 17-20	2153093-5
Port ID label MRJ21 XG, 21-24	2153093-6
Port ID label MRJ21 XG, 25-28	2153093-7
Port ID label MRJ21 XG, 29-32	2153093-8

Index

Part Number Index.....	308
Reliable Performance.....	318

Index

Part Number Index

Part Number	Page	Part Number	Page	Part Number	Page
0					
023826	191	1375192	254	1499418	243, 253
1		1375253	23, 294	1499659	138
101016	275, 277	1375254	294	1499836	255, 292
101019	49	1375308	286	1499855	255, 292
136816	242	1375309	286	1534332	188
182398	200	1375310	286	1553212	203
183553	155	1375352	305	1553661	207
183578	155	1375353	305	1553761	87
183635	153	1375361	255, 292	1553785	213
183636	152	1375362	255, 292	1557548	138
183641	153	1375363	255, 292	1568757	181
183931	187, 281	1375364	255, 292	1583236	286
185705	281	1375365	255, 292	1583608	286
969704	304	1375366	255, 292	1588175	207
1116412	255, 292	1379156	148, 281	1588176	207
1116571	287	1394060	133, 256	1588756	208
1116697	284	1394294	274	1591020	298
1116698	284	1418730	169	1591022	298
1206114	168	1418731	169	1591024	297
1206121	172	1418732	169	1591026	297
1206134	172	1418733	169	1591029	297
1206138	168	1418734	169	1591030	297
1206144	172	1418735	169	1591031	297
1206145	172	1418770	171	1591032	297
1206146	172	1418800	172	1591034	297
1206343	168	1435346	137	1591185	296
1206480	168	1435657	129	1591188	296
1206505	168	1435688	129	1591313	302
1206704	169	1435689	129	1591360	127
1278017	192	1435725	130	1591363	127
1278118	203	1435726	130	1591364	127
1278328	177	1435791	130	1591530	302
1278346	204	1435796	130	1591721	150
1278368	176	1435797	130	1644016	155
1278531	207	1435827	137	1644042	132, 236
1278625	207	1435939	137	1644077	250
1278637	207	1435954	133	1671000	168
1278755	174	1435965	31	1671002	168
1278949	205	1435971	31	1671017	168
1339123	255, 292	1457628	209	1671054	172
1348960	168	1457630	208	1671080	48
1350376	189	1479002	305	1671113	49
1350377	189	1479003	305	1671116	174
1374416	186, 255, 292	1479181	255, 292	1671117	175
1374463	176	1479190	255, 292	1671121	169
1374484	210	1479191	255, 292	1671130	169
1374526	174	1479230	293	1671136	134
1374598	176	1479231	293	1671143	30
1375055	233	1479232	293	1671146	177
1375092	304	1479437	294	1671147	49
1375149	293	1479440	294	1671149	129
1375187	233	1479441	294	1671157	265
1375189	244	1479506	177	1671164	188, 272
1375190	244	1479698	173, 291	1671168	177
1375191	244	1479701	291	1671175	35
		1499101	218	1671183	266

Index

Part Number Index

Part Number	Page	Part Number	Page	Part Number	Page
1671187	134	1671660	125	1711342	232
1671189	51	1671711	48	1711343	232
1671195	173	1671907	92	1711348	279
1671196	173	1671925	273	1711349	281
1671197	173	1671933	47	1711351	136
1671200	22, 173	1671938	47	1711399	278
1671201	173	1671961	23	1711400	278
1671202	173	1673956	286	1711403	278
1671205	09	1695790	190	1711404	278
1671206	09	1711000	155	1711409	149
1671207	09	1711001	155	1711437	219
1671209	129	1711003	218	1711441	219
1671226	04	1711005	225	1711450	154
1671227	04, 05	1711006	231	1711481	219
1671228	04	1711007	231	1711485	270
1671229	129	1711008	231	1711490	270
1671262	167	1711027	238	1711491	279
1671263	167	1711040	249	1711494	253
1671268	167	1711043	243	1711495	253
1671269	167	1711053	231	1711496	253
1671271	167	1711076	240	1711500	156
1671272	167	1711077	240	1711537	270
1671273	171	1711078	240	1711548	136
1671274	171	1711079	240	1711563	224
1671281	200	1711082	276	1711564	224
1671330	42	1711083	276	1711579	220
1671331	290	1711091	241	1711580	223
1671365	167	1711093	241	1711592	227
1671373	22	1711094	241	1711604	275
1671405	44	1711095	241	1711605	277
1671414	144, 268	1711096	241	1711606	275
1671415	306	1711100	154	1711609	149
1671436	21	1711125	153	1711613	222
1671437	21	1711135	154	1711618	222
1671495	48	1711147	132, 236	1711623	222
1671508	46	1711148	135	1711624	223
1671545	44	1711160	232	1711625	276
1671547	50	1711163	225	1711626	276
1671548	50	1711168	275	1711632	275
1671549	51	1711169	275	1711633	275
1671550	50	1711171	239	1711634	277
1671551	50	1711195	225	1711637	221
1671552	51	1711255	274	1711644	277
1671554	45	1711275	278	1711653	281
1671555	45	1711276	281	1711655	145
1671578	45	1711277	281	1711659	223
1671579	45	1711282	276	1711664	281
1671587	46	1711283	277	1711666	238
1671590	265	1711295	232	1711685	135, 266
1671594	265	1711301	279	1711686	143
1671603	51, 52	1711302	279	1711691	227, 232
1671609	47	1711306	281	1711716	227
1671610	47	1711307	281	1711742	135
1671614	46	1711314	22	1711749	135
1671618	52	1711336	150	1711755	136
1671633	92	1711339	155	1711756	136

Index

Part Number Index

Part Number	Page	Part Number	Page	Part Number	Page
1711757	136	1716217	166	1918802	26, 212
1711758	32	1716218	166	1918803	26, 212
1711760	136	1716219	166	1918804	212
1711774	32	1716220	166	1918805	26, 212
1711775	279	1716293	160	1918806	26, 212
1711776	220	1716294	160	1918807	212
1711777	238	1716295	160	1918808	212
1711787	223	1716296	160	1918809	26, 212
1711789	34	1716297	160	1918810	212
1711796	150	1716298	160	1918811	212
1711797	281	1716299	160	1920743	08
1711801	151	1716300	160	1933096	255, 292
1711804	151	1716301	160	1933098	137
1711807	151	1725150	286	1933140	306
1711815	230	1754074	208	1933192	255, 292
1711816	230	1754137	207	1933193	255, 292
1711817	230	1754371	193, 197	1933194	255, 292
1711818	230	1754462	204	1933196	134
1711819	230	1754603	205	1933197	134
1711820	230	1754708	207	1933241	137
1711825	229	1754765	213	1933286	255, 292
1711826	230	1754766	213	1933287	285
1711851	229	1754767	213	1933288	285
1711855	146	1754768	213	1933327	133
1711856	145	1754845	203	1933328	133
1711858	146	1777029	31, 131	1933329	133
1711860	148	1777041	131	1933330	133
1711861	147	1777042	131	1933331	133
1711862	147	1777053	131	1933332	133
1711864	147	1777098	31	1933333	133
1711865	147	1828352	214	1933334	133
1711866	147	1828353	214	1933352	36
1711869	146	1828833	213	1933420	129
1711870	145	1828836	213	1933425	138
1711875	145	1828837	213	1933476	228
1711876	146	1828953	194	1933582	255, 292
1711910	218	1859096	279	1933659	255, 292
1711913	218	1859130	281	1933661	255, 292
1711937	277	1859160	49	1933668	284
1711944	31, 131	1859345	231	1933671	284
1711963	278	1871696	202, 206	1933674	284
1711970	30	1918266	197	1933677	284
1711987	22, 173	1918267	197	1933691	290
1711990	240	1918372	197	1933692	290
1711991	240	1918373	197	1933693	290
1711992	240	1918374	197	1933776	290
1711993	240	1918375	197	1933899	137
1711994	240	1918376	197	1985374	195
1711995	240	1918377	197	1985766	207
1711996	240	1918384	197	1985771	206
1716000	162	1918385	197	1985805	195
1716001	163	1918388	197	1987031	300
1716029	161	1918626	193	1987032	300
1716211	166	1918627	193	1987033	300
1716216	166	1918652	210	1987152	299

Index

Part Number Index

Part Number	Page	Part Number	Page	Part Number	Page
1987154	300	2055727	178	2153040	131
1987155	300	2055728	178	2153041	28
1987195	302	2055740	178	2153046	28
1987256	301	2055741	178	2153049	131
1987257	301	2064181	193	2153052	29
2		2064184	194	2153074	147
216056	05	2064431	207	2153075	147
219413	242	2064499	26, 212	2153078	29
219420	242	2064500	26, 212	2153091	131
219484	242	2064540	206	2153093	306
219584	231	2064603	207	2153112	142
219585	231	2064651	211	2153113	142
228433	210	2111008	283	2153115	28
284584	152	2111009	283	2153117	156
2055108	08	2111010	283	2153140	40
2055109	08	2111011	283	2153141	40
2055425	185	2111012	283	2153142	40
2055438	130	2111013	283	2153146	39
2055567	23	2111014	283	2153147	39
2055576	03	2111015	283	2153148	39
2055577	03	2111093	291	2153149	39
2055578	03	2111117	291	2153150	38
2055579	03	2111121	245	2153151	38
2055580	06	2111122	245	2153152	38
2055581	06	2111123	235	2153161	225
2055583	178	2111124	235	2153173	144
2055584	178	2111201	283	2153175	128
2055600	06	2111203	283	2153188	94
2055611	03	2111366	32	2153190	94
2055612	03	2111367	33	2153211	03
2055613	178	2111370	34	2153216	269
2055614	178	2111371	32	2153217	240
2055623	06	2111440	128	2153230	29
2055624	06	2111441	128	2153240	252
2055665	178	2111442	128	2153241	251
2055666	178	2111443	128	2153244	03
2055667	178	2111444	128	2153245	177
2055668	178	2111445	128	2153264	156
2055670	178	2111446	128	2153273	251
2055687	178	2111447	128	2153274	251
2055688	178	2111448	128	2153275	251
2055691	07	2111481	87	2153276	251
2055704	06	2111500	255, 292	2153277	251
2055707	08	2111521	29	2153278	251
2055708	08	2111522	29	2153279	251
2055709	08	2111615	255, 292	2153285	252
2055710	08	2111664	26, 212	2153286	252
2055711	08	2111676	228	2153290	226
2055712	08	2119000	287	2160008	180
2055713	08	2119700	287	2160012	11
2055714	08	2123273	213	2160013	11
2055715	03	2125019	190	2160040	185
2055716	03	2153004	279	2160041	185
2055725	178	2153014	144, 291	2160042	185
2055726	178	2153022	226	2160043	185

Index

Part Number Index

Part Number	Page	Part Number	Page	Part Number	Page
2160046	08	2160199	10	2160729	03
2160047	08	2160266	16	2160730	03
2160048	08	2160270	89	2160738	18
2160052	130	2160301	90	2171014	226
2160067	07	2160302	90	2193016	87
2160069	07	2160304	18	2193050	87
2160071	08	2160305	18	2193051	87
2160072	08	2160307	18	2193052	87
2160073	03	2160317	88	2255669	178
2160074	03	2160318	88	2269019	44
2160075	03	2160319	88	2286081	101
2160076	03	2160320	88	3	
2160077	08	2160321	88	336455	156
2160078	08	2160322	88	336488	221
2160106	11	2160323	88	336526	266
2160107	11	2160324	88	336548	152
2160108	11	2160325	88	336556	149
2160109	11	2160349	180	336608	272
2160110	11	2160385	88	336613	270
2160111	11	2160386	88	336614	270
2160112	06	2160387	88	336671	246
2160113	06	2160388	88	336793	281
2160114	06	2160389	88	300001739943	267
2160115	06	2160390	88	300001739995	267
2160116	11	2160391	88	300001741753	267
2160117	11	2160392	88	300001743975	227
2160122	11	2160404	180	300001743978	228
2160123	11	2160503	88	4	
2160124	11	2160506	96	406330	247
2160125	11	2160510	19	406331	247
2160126	06	2160537	96	492025	207
2160127	06	2160538	96	492026	207
2160128	11	2160546	07	492109	207
2160129	11	2160547	215	492543	203
2160134	10	2160548	215	492622	207
2160135	05	2160549	215	492623	207
2160136	05	2160550	215	492697	203
2160137	10	2160551	215	492703	206
2160138	10	2160552	215	492782	207
2160139	05	2160588	180	492783	207
2160140	05	2160608	15	5	
2160141	10	2160609	15	5909 1 076	258
2160142	178	2160627	20	5909 1 078	258
2160143	178	2160639	16	5909 1 082	258
2160144	178	2160640	16	5909 1 083	258
2160145	178	2160649	17	5909 1 084	258
2160146	06	2160650	17	57535	243
2160147	06	2160651	17	57538	243
2160192	10	2160654	18	57893	225
2160193	05	2160658	03	58424	207
2160194	05	2160659	03	58433	207
2160195	10	2160663	15	501014	207
2160196	10	2160664	15	501197	209
2160197	05	2160693	07	501198	207
2160198	05	2160694	18	501258	204

Index

Part Number Index

Part Number	Page	Part Number	Page	Part Number	Page
501381	191	599145	161	5349561	182
501457	199	599146	161	5349565	182
501473	210	599148	161	5349567	182
501523	209	599149	161	5349568	185
501818	208	599152	162	5349569	186
501857	208	599153	162	5349574	182
501858	209	599154	162	5349578	182
502129	209	599156	162	5349580	182
502134	209	599157	162	5349582	186
502222	209	599159	162	5349584	185
502259	208	599160	162	5492123	198
502282	210	599161	162	5492642	194
502418	210	599162	162	5492643	194
502613	199	599164	162	5502580	199
502631	208	599165	162	5502632	191
502656	208	599167	162	5502776	190, 191
502748	210	599168	164	5502780	192
502750	191	599169	164	5503137	192
503304	208	599170	164	5503628	199
503330	203	599172	164	5503692	196
503337	208	599173	164	5503693	196
503577	201	599175	164	5503948	198
503605	202	599602	161	5503971	198
503676	199	599603	161	5504000	196
503677	199	599605	162	5504034	196
503681	201	599606	162	5504600	196
503705	206	599607	162	5504614	191
503746	205	599609	162	5504640	190
503787	208	599610	162	5504646	198
503910	207	599611	162	5504655	198
503911	207	599612	164	5504657	198
503957	203	599613	164	5504663	192
504021	191	599614	163	5504932	198
504035	209	599615	163		
504064	208	599616	163	6	
504290	208	599617	163	6089 1 102	257
555050	254	599618	163	6089 1 810	257
555052	254	599619	163	6092 1 810	257
555614	155	599620	163	6092 1 820	257
555644	155	599621	163	6406 1 015	263
558198	304	599622	163	6406 2 004	263
558199	304	599623	163	6406 2 013	263
558251	283	599624	163	6406 3 003	263
558329	49	599625	163	6417 2 055	287
558821	304	599626	163	6424 3 005	259
559066	202	599627	163	6424 3 007	259
559087	202	599628	163	6424 3 009	259
559496	174	599628	163	6424 3 010	259
559501	174	599629	163	6428 2 418	264
559523	177	599681	165	6428 2 419	264
559558	176	599682	165	6428 2 420	264
559596	176	599683	165	6428 2 421	264
559601	176	599690	165	6428 2 422	264
599142	159	599692	165	6428 2 423	264
599144	161	5233103	185	6428 2 424	264
		5233582	185	6428 2 425	264

Index

Part Number Index

Part Number	Page	Part Number	Page	Part Number	Page
6429 1 076	262	6206650	159	6695506	185
6429 1 078	262	6206820	184	6695507	185
6436 1 013	263	6206821	184	6695508	185
6436 2 004	263	6278049	190	6695509	185
6436 3 003	263	6278079	194	6695510	185
6437 1 020	263	6278082	194	6695511	185
6437 2 004	263	6348260	13, 182	6695512	185
6437 2 010	263	6348269	184	6695657	181
6437 3 003	263	6348271	184	6695697	181
6467 1 140	288	6348522	194, 196, 198	6754482	193
6467 2 142	288	6348941	186	6754483	193
6467 2 149	288	6348942	186	7	
6527 1 607	247	6374906	192	7014 2 003	260
6529 1 022	258	6391366	186	7014 2 004	260
6529 1 042	258	6457493	198	7014 2 058	260
6530 1 017	262	6457567	190	7014 2 065	260
6534 1 001	257	6536444	184	7014 2 250	260
6536 1 005	280	6536445	184	7014 3 252	260
6536 3 044	280	6536446	184	7019 1 214	261
6537 1 610	287	6536447	184	7022 1 015	246
6538 3 111	280	6536462	183	7022 2 155	267
6538 4 111	278	6536463	183	7022 4 001	256
6540 1 677	248	6536464	13, 182	7033 1 080	170
6540 1 678	237	6536501	12, 180	7033 1 082	170
6540 1 684	237	6536502	180	7033 1 084	170
6540 1 801	278	6536503	180	7033 1 101	170
6540 1 802	278	6536508	13, 181	7033 1 103	170
6540 1 810	279	6536509	181	7033 1 180	170
6540 1 812	278	6536510	181	7033 1 182	170
6540 1 813	279	6536511	183	7080 2 064	285
6540 1 814	279	6536512	183	7080 2 065	285
6577 2 812	259	6536513	183	7033106902	189
6645 1 180	125	6536555	185	7033106904	189
6645-2-827	230	6536556	186	7033107102	189
6690 1 825	282	6536767	182	7033107104	189
6690 2 675	271	6536769	184	9	
6690 3 725	271	6536770	184	959305	250
6690 3 745	282	6536803	184	959306	250
6753 2 009	257	6536810	184	959307	250
6830 1 490	288	6536811	184	959308	250
6830 1 800	234	6536880	185	959309	250
6830 1 810	232	6536966	185	959385	240
6830 1 811	227	6536967	13, 181	964361	272
6830 1 885	228	6536968	183	964719	274
6830 2 402	279	6536969	12, 180	964830	272
657054	200	6536974	185	966223	271
6206158	182	6536975	185	966224	271
6206613	183	6588291	194	966498	273
6206615	183	6693276	194	966740	188, 272
6206616	184	6695121	181	966936	187, 271
6206617	183	6695240	214	969556	285
6206619	183	6695242	214	969614	169
6206620	184	6695244	214	969615	169
6206621	183	6695313	184	969616	169
6206623	183	6695505	185	969617	169

Index

Part Number Index

Part Number	Page	Part Number	Page	Part Number	Page
969618	169	FGS-HSHC-10	55	FGS-MFAW-A	61
969619	169	FGS-HTUB-F-XX	83	FGS-MFAW-F	75
969628	169	FGS-HTUB-XX	82	FGS-MFAW-H	78
969629	169	FGS-HUFB-A	82	FGS-MH4A-C	54
969630	169	FGS-ISLAND3-F	73	FGS-MH4E-A	58
969631	169	FGS-ISLAND-F	73	FGS-MH4E-B	66
969704	156	FGS-ISLAND-F-513	73	FGS-MH4E-F	71
969993	169	FGS-ISLAND-H/F	77	FGS-MH4E-G	63
969994	169	FGS-JUNC-G	64	FGS-MH4E-H	76
		FGS-KDH2-C	55	FGS-MH4E-H-VS	84
F		FGS-KT03-	55, 60, 63, 68, 73, 81	FGS-MH9A-C	54
		FGS-KT07-	60, 68	FGS-MH9A-C-45/2	54
F		FGS-MCDS-AB	60	FGS-MH9E-A	58
FGS-ASRI-	60, 68	FGS-MCDS-AB**	68	FGS-MH9E-B	66
FGS-DHCP	61, 64, 69, 74	FGS-MCDS-EX-AB	60, 68	FGS-MH9E-F	71
FGS-DHHC	61, 69, 74	FGS-MD4A-C	54	FGS-MH9E-F-VS	71
FGS-FD4E-H	78	FGS-MD4E-A	58	FGS-MH9E-G	63
FGS-FDSA-HF	78	FGS-MD4E-B	66	FGS-MHIS-A	58, 66, 71
FGS-FH4E-H	78	FGS-MD4E-F	71	FGS-MHIS-A/H	76
FGS-FHRT-H	78	FGS-MD4E-G	63	FGS-MHIS-B	58, 66, 71
FGS-FHRT-H/F	78	FGS-MD4E-H	76	FGS-MHIS-B/H	76
FGS-FHXP-F/H	78	FGS-MD9A-C	54	FGS-MHIS-F	58, 66, 71
FGS-FHXP-H	78	FGS-MD9E-A	58	FGS-MHIS-F/H	76
FGS-FRH-	79	FGS-MD9E-B	66	FGS-MHIS-JIG-A/B/F	58, 66, 71
FGS-FSFC-H	78	FGS-MD9E-F	71	FGS-MHRT-A	58
FGS-HCBL-12	82	FGS-MD9E-G	63	FGS-MHRT-B	66
FGS-HCBL-15	82	FGS-MDRT-F	73	FGS-MHRT-F	71
FGS-HDLB-3	82	FGS-MDSA-AB	58, 66	FGS-MHRT-F/B	71
FGS-HDSI-AB	60, 68	FGS-MDSA-AC	54	FGS-MHRT-F/B-VS	71
FGS-HDSI-F/C	73	FGS-MDSA-F2B	71	FGS-MHRT-F-VS	71
FGS-HDSI-F/D	73	FGS-MDSA-FB	66, 71	FGS-MHRT-G	63
FGS-HETP-F-XX	83	FGS-MDSA-FB-L	71	FGS-MHRT-H	76
FGS-HETP-H-5/8	84	FGS-MDSA-FB-R	71	FGS-MHRT-H/F	76
FGS-HETR-5/8-A	82	FGS-MDSA-GA	63	FGS-MHRT-H/F-VS	84
FGS-HETR-F-XX	83	FGS-MDSA-GB	63	FGS-MHTA-C	54
FGS-HETR-XX	82	FGS-MDSA-HF	76	FGS-MHXP-A	58
FGS-HLBK	82	FGS-MDSP-2B	68	FGS-MHXP-B	66
FGS-HMEC-A	58	FGS-MDSP-2B-IMP	68	FGS-MHXP-B/F	71
FGS-HMEC-B	66	FGS-MDSP-A	60	FGS-MHXP-B/F-VS	71
FGS-HMEC-C	54	FGS-MDSP-A/I	60	FGS-MHXP-C	54
FGS-HMEC-F	71	FGS-MDSP-B	68	FGS-MHXP-F	71
FGS-HMEC-G	63	FGS-MDSP-B/I	68	FGS-MHXP-F/H	76
FGS-HMEC-H	76	FGS-MDSP-C	55	FGS-MHXP-F/H-VS	84
FGS-HNLR-AB	82	FGS-MDSP-EX-A	60	FGS-MHXP-F-VS	71
FGS-HNLR-F	83	FGS-MDSP-EX-B	68	FGS-MHXP-G	63
FGS-HNTP-F-XX	83	FGS-MDSP-F	73	FGS-MHXP-H	76
FGS-HNTP-H-5/8	84	FGS-MDSP-F/I	73	FGS-MHXP-H-VS	84
FGS-HNTR-5/8-A	82	FGS-MDSP-F-VS	71	FGS-MJWR-A	60, 68
FGS-HNTR-F-XX	83	FGS-MDSP-G	63	FGS-MJWR-C	56
FGS-HNTR-XX	82	FGS-MEX1-C-	55, 81	FGS-MSDS-C	55
FGS-HNTS-F-XX	83	FGS-MEXC-	80	FGS-MSHA-C	56
FGS-HNTS-F-XX-LP	83	FGS-MEXP-A/B/F	81	FGS-MSHS-A	61
FGS-HNTS-XX	82	FGS-MEXP-E-A/B/F	80	FGS-MSHS-B	69
FGS-HNTS-XX-LP	82	FGS-MEXP-LP-A/B/F	81	FGS-MSHS-F	74
FGS-HOMX-16MM	82	FGS-MEXP-LP-G	63	FGS-MSHS-G	64

Index

Part Number Index

Part Number	Page	Part Number	Page	Part Number	Page
FGS-MSHS-H	78	FGS-SU4E-F	71	QFB-48FDLCLM2BPHR	104
FGS-MSHS-STOR-B	69	FGS-SU9E-A	58	QFB-48FDLCLM2BSHR	104
FGS-MSHS-STOR-F	74	FGS-VDSA-FB-L	71	QFB-48FDLCLM2FPHR	105
FGS-MSNC-A	61	FGS-VDSA-FB-R	71	QFB-48FDLCLM2FSHR	105
FGS-MSNC-B/G	64, 69			QFB-48FDLCLM4APHR	105
FGS-MSNC-F	74			QFB-48FDLCLM4ASHR	105
FGS-MSSC-A	61	Q		QFB-48FDLCLM4BPHR	105
FGS-MSSC-B/G	64, 69	Q		QFB-48FDLCLM4BSHR	105
FGS-MSSC-F	74	QCH-	102	QFB-48FDLCLM4FPHR	105
FGS-MTRM-2B	68	QCPC-	124	QFB-48FDLCLM4FSHR	105
FGS-MTRM-2B-IMP	68	QCPP-	122	QFB-48FDLCLM4FSHR	105
FGS-MTRM-A	60, 68	QCPU-MCBM-1	103	QFB-48FDLCLM4FPHR	105
FGS-MTRM-B	68, 73	QCPU-MPPM-1	123	QFB-48FDLCLM4FPHR	105
FGS-MTRM-C	55, 81	QDR-	25, 103	QFB-48FDLCLM4FPHR	105
FGS-MTRM-F	73	QE-ADP-	114	QFB-48FDLCLM4FPHR	105
FGS-MTRM-G	63	QE-FPC-	119	QFB-48FDLCLM4FPHR	105
FGS-MTRM-H	77	QE-FPM-	118	QFB-48FDLCLM4FPHR	105
FGS-MU4A-C	54	QE-HEP-10000S0000	112	QFB-48FDLCLM4FPHR	105
FGS-MU4E-A	58	QE-HEP-1000000000	112	QFB-48FDLCLM4FPHR	105
FGS-MU4E-B	66	QE-HEP-ACC1DRK0000	121	QFB-48FDLCLM4FPHR	105
FGS-MU4E-F	71	QE-HEP-ACCUCCL0000	121	QFB-48FDLCLM4FPHR	105
FGS-MU4E-G	63	QE-HEP-ACCUCCS0000	121	QFB-48FDLCLM4FPHR	105
FGS-MU4E-H	76	QE-HEP-ACCUFKL0000	121	QFB-48FDLCLM4FPHR	105
FGS-MU9A-C	54	QE-HEP-ACCUFKR0000	121	QFB-48FDLCLM4FPHR	105
FGS-MU9E-A	58	QE-HEP-ACCUPWR0000	121	QFB-48FDLCLM4FPHR	105
FGS-MU9E-B	66	QE-HEP-ACCUPWR0001	121	QFB-48FDLCLM4FPHR	105
FGS-MVAR-A	58, 61	QE-HEP-CTR1000000	113	QFB-48FDLCLM4FPHR	105
FGS-MVAR-B	66, 69	QE-IFC-	120	QFB-48FDLCLM4FPHR	105
FGS-MVAR-F	71, 74	QE-MPM-	116	QFB-48FDLCLM4FPHR	105
FGS-SD4E-A	58	QFA-1FFM3ZPxxxMNN	107	QFB-48FDLCLM4FPHR	105
FGS-SD4E-B	66	QFA-1FFM4ZPxxxMNN	107	QFB-48FDLCLM4FPHR	105
FGS-SD4E-F	71	QFA-1WWSMZPxxxMNN	107	QFB-48FDLCLM4FPHR	105
FGS-SD9E-A	58	QFA-2FFM3ZNxxxMBB	107	QFB-48FDLCLM4FPHR	105
FGS-SD9E-B	66	QFA-2FFM4ZNxxxMBB	107	QFB-48FDLCLM4FPHR	105
FGS-SD9E-F	71	QFA-2WWSMZNxxxMBB	107	QFB-48FDLCLM4FPHR	105
FGS-SDSA-AB	58, 66	QFA-4FFM3ZNxxxMBB	107	QFB-48FDLCLM4FPHR	105
FGS-SDSA-F2B	71	QFA-4FFM4ZNxxxMBB	107	QFB-48FDLCLM4FPHR	105
FGS-SDSA-FB	66, 71	QFA-4WWSMZNxxxMBB	107	QFB-48FDLCLM4FPHR	105
FGS-SDSP-F	73	QFA-8FFM3ZNxxxMBB	107	QFB-48FDLCLM4FPHR	105
FGS-SH4E-A	58	QFA-8FFM4ZNxxxMBB	107	QFB-48FDLCLM4FPHR	105
FGS-SH4E-B	66	QFA-8WWSMZNxxxMBB	107	QFB-48FDLCLM4FPHR	105
FGS-SH4E-F	71	QFA-26WSMZyxxxMBB	109	QFB-48FDLCLM4FPHR	105
FGS-SH9E-A	58	QFA-122M3ZPxxxMNN	108	QFB-48FDLCLM4FPHR	105
FGS-SH9E-B	66	QFA-122M4ZPxxxMNN	108	QFB-48FDLCLM4FPHR	105
FGS-SH9E-F	71	QFA-222M3ZNxxxMBB	108	QFB-48FDLCLM4FPHR	105
FGS-SHRT-A	58	QFA-222M4ZNxxxMBB	108	QFB-48FDLCLM4FPHR	105
FGS-SHRT-B	66	QFA-242M4ZYxxxMBB	109	QFB-48FDLCLM4FPHR	105
FGS-SHRT-F	71	QFA-244M4ZNxxxMBB	109	QFB-48FDLCLM4FPHR	105
FGS-SHRT-F/B	71	QFA-266SMZNxxxMBB	109	QFB-48FDLCLM4FPHR	105
FGS-SHXP-A	58	QFA-422M3ZNxxxMBB	108	QFB-48FDLCLM4FPHR	105
FGS-SHXP-B	66	QFA-422M4ZNxxxMBB	108	QFB-48FDLCLM4FPHR	105
FGS-SHXP-B/F	71	QFA-822M3ZNxxxMBB	108	QFB-48FDLCLM4FPHR	105
FGS-SHXP-F	71	QFA-822M4ZNxxxMBB	108	QFB-48FDLCLM4FPHR	105
FGS-SU4E-A	58	QFB-48FDLCLM4FPHR	104	QFB-48FDLCLM4FPHR	105
FGS-SU4E-B	66	QFB-48FDLCLM4FPHR	104	QFB-48FDLCLM4FPHR	105

XG_A 10 Gb/s Approved

High-speed 10 Gigabit Ethernet over Twisted Pair and Fiber Optic Cabling

The AMP NETCONNECT XG Systems, comprising Cat. 6 Copper and OM3 Fiber products have become firmly established industry-leading portfolios with excellent 10 Gb/s performance.

As transmission and connectivity technologies have progressed, TE has developed products which exploit these technological advantages: our AMP NETCONNECT XG_A Systems include our Cat. 6_A Copper and OM4 Fiber portfolios to become an end-to-end 10 Gb/s infrastructure solutions. They are fully compliant with the latest ISO/IEC 11801 Amendment 2 specifications.

The **XG_A 10 Gb/s approved** seal is an indicator for all products of the XG_A family.



ISO Cat. 6_A

An augmented Category 6 specification

All products in this catalog that feature the **ISO Cat. 6_A** seal are compliant with the global cabling standard ISO/IEC 11801 Amendment 2.

This amendment defines specifications for Cat. 6_A components and Class E_A permanent links. These global Cat. 6_A / Class E_A specifications require a generation of connecting hardware offering far superior performance compared to the existing products which are based on the American TIA standard.

Benefits of this higher standard include more headroom, "mix & match" capability, enabling short links, and removing the requirement for ANEXT testing.



Ensured Performance

Optimized Physical Contact (OPC) enhances your link parameters

Why do you require a controlled ferrule end face? Enhanced services such as Gigabit, 10 Gigabit and soon 40/100 Gigabit Ethernet require a high quality cabling system. Therefore, IEC 608749 specifies the dimensional details of fiber optic connectors in order to ensure interoperability and performance within an ISO 11801 specified application. These dimensional requirements are directly related to the endface characteristics of a polished ferrule, namely its **radius, dome offset** and **fiber position**.

If these ferrule characteristics are optimal, an **Optimized Physical Contact (OPC)** between the two connectors is guaranteed. This will enhance data transmission parameters like **optical performance, Attenuation, Return Loss** and **data link stability**.

Also, the optical **interoperability** between connectors of different suppliers can be ensured by controlled endfaces. As a result of **OPC** a stable physical contact between the endfaces is achieved. This provides a very low Insertion Loss as well as a high Return Loss in order to run high speed applications like 10/40/100 Gigabit Ethernet. All products in this catalog that feature the **Ensured Performance** logo provide **OPC** at all time. AMP NETCONNECT guarantees a controlled endface for all OM3, OM4 and OS2 assemblies and field installable products (MT-RJ and LightCrimp Plus).



Universal Connectivity Platform

Rack efficiency and multiple media deployment

The Universal Connectivity Platform (UCP) is designed to deliver rack efficiency and multiple media deployment. It comprises a versatile range of components that include patch panels, subfloor panel and overhead panel mounts, pre-terminated links and adaptor modules. One common patch panel, either angled or flat, is used to accommodate both copper and fiber, and the units can be installed within or outside the 19-inch envelope. Side mounting brackets maximize usable space along the vertical posts of the rack system, while adaptive mounting brackets can be used strategically above and below the racks.

The UCP accepts pre-terminated copper assemblies, fiber cassettes and MRJ21 high density copper connectivity cassettes, for faster deployment and high reliability. It is also fully compatible with TE Connectivity's AMPTRAC managed connectivity solution.

Products which can be used inside the Universal Connectivity Platform are marked with the **UCP Compatible** seal.



RoHS Ready

Restriction on the Use of Hazardous Substances

TE Connectivity will support your RoHS requirements. We've assessed more than 1.5 million end items/components for RoHS compliance, and issued new part numbers where required in the process of eliminating the restricted materials. All part numbers in this catalog are RoHS compliant. These products comply with European Union Directive 2002/95/EC as amended 1 January 2006 that restricts the use of lead, mercury, cadmium, hexavalent chromium, PBB, and PBDE in certain electrical and electronic products sold into the EU as of 1 July 2006.

NOTE: For purposes of this catalog, included within the definition of RoHS Compliant are:

- Products that are clearly "Out of Scope" of the RoHS Directive such as hand tools and other non-electrical accessories.
- Products that contain lead in solderable interfaces (they do not contain any of the other five restricted substances above allowable limits). However, these products are covered by an application-based exception for lead in solders, such as the server, storage, or networking infrastructure exemption of the same directive.

NOTE: Information regarding RoHS compliance is provided based on reasonable inquiry of our suppliers and represents our current actual knowledge based on the information provided by our suppliers. This information is subject to change.



Wiring Diagrams for Modular Plugs and Jacks

T568A Wiring

T568B Wiring

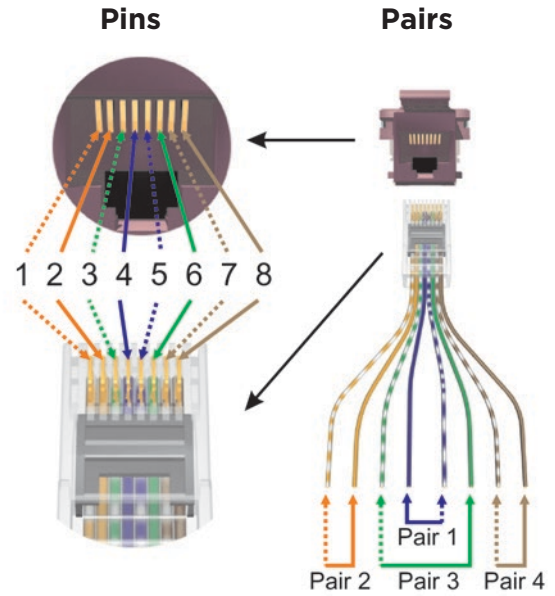
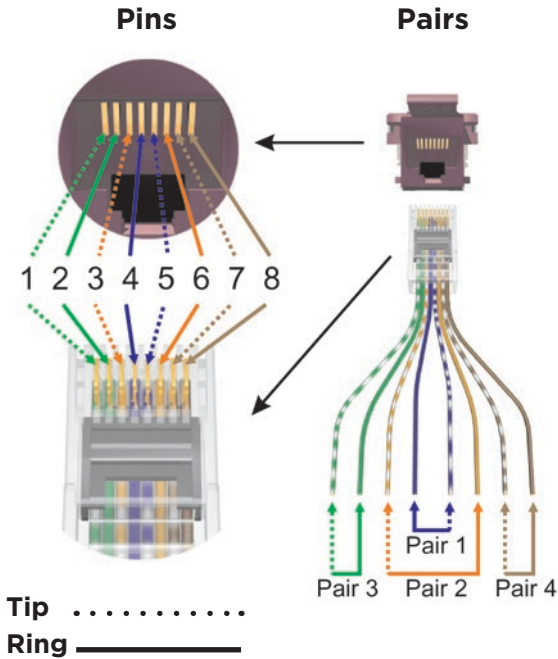

Application Wiring Diagrams for Modular Jacks

- 10Base-T
- 100Base-TX

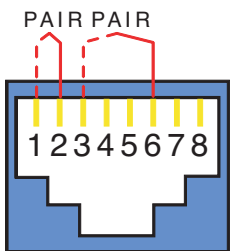

Tip
Ring _____

- 1000Base-T
- 10GBase-T

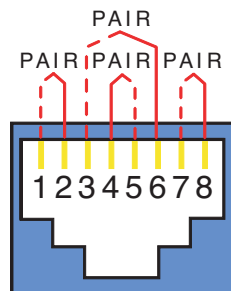

- Token Ring
- ISDN, xDSL

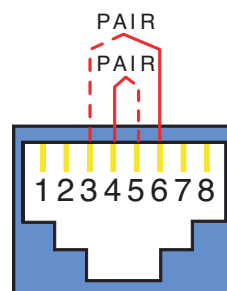

- ATM/TP-PMD
- 1000Base-TX2

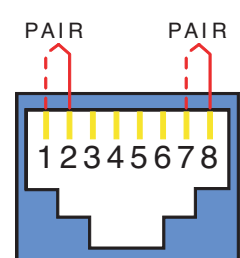

Note: All of the applications listed above (as well as most other communications applications) can be implemented on both T568A and T568B jacks.

EVERY CONNECTION COUNTS



THE WORLD LEADER IN FIBER CONNECTIVITY

DELIVERING FIBER CONNECTIVITY FROM ORIGINATION TO DESTINATION

Fiber is the backbone of the world's information infrastructure, enabling society's ever-increasing reliance on high-speed, media-rich communications. TE builds the critical connections that make fiber deployment faster, capacity greater, installation simpler and network reliability better. From design to delivery to what comes next, we make sure every connection counts.

TE BROADBAND NETWORK SOLUTIONS REGIONAL SALES HEADQUARTERS:

North America Greensboro, NC, USA Ph: +1-800-553-0938 Fx: +1-717-986-7406	Latin America Buenos Aires, Argentina Ph: +54-11-4733-2200 Fx: +54-11-4733-2282	EMEA Kessel-Lo, Belgium Ph: +32-16-35-1321 Fx: +32-16-35-2188	SAARC Bangalore, India Ph: +91-80-4011-5000 Fx: +91-80-4011-5030	Asia Hong Kong, China Ph: +852-2735-1628 Fx: +852-2735-1625	Pacific Sydney, Australia Ph: +61-2-8748-9500 Fx: +61-2-9748-8487
---	---	---	--	---	---

TE BROADBAND NETWORK SOLUTIONS IN EUROPE, MIDDLE EAST AND NORTH AFRICA:

Austria Vienna Ph: +43-1-90560-1204 Fx: +43-1-90560-1270	Denmark Glostrup Ph: +45-70-15-52-00 Fx: +45-43-44-14-14	Hungary Budapest Ph: +36-1-289-1007 Fx: +36-1-289-1010	Norway Nesbru Ph: +47-99-66-77-50 Fx: +47-66-77-88-98	Spain Montcada (Barcelona) Ph: +34-93-291-0330 Fx: +34-93-291-0608	UK Tewkesbury, Glos Ph: +44-1684-857966 Fx: +44-1684-857988
Belarus Minsk Ph: +375-17-237-47-94 Fx: +375-17-237-47-94	Egypt Cairo Ph: +20-2-2419-2334 Fx: +20-2-2417-7647	Italy Collegno (Torino) Ph: +39-011-4012-111 Fx: +39-011-4012-268	Poland Warsaw Ph: +48-22-4576-700 Fx: +48-22-4576-720	Sweden Upplands Väsby Ph: +46-8-5072-5000 Fx: +46-8-5072-5001	Ukraine Kiev Ph: +380-44-206-2265 Fx: +380-44-206-2264
Belgium Kessel-Lo Ph: +32-16-35-2326 Fx: +32-16-35-2353	Finland Helsinki Ph: +358-95-12-34-20 Fx: +358-95-12-34-250	Kazakhstan Almaty Ph: +7-327-244-5875 Fx: +7-327-244-5877	Portugal Evora Ph: +351-961-377-331 Fx: +351-211-454-506	Switzerland Steinach Ph: +41-71-447-0-447 Fx: +41-71-447-0-423	
Bulgaria Sofia Ph: +359-2-971-2152 Fx: +359-2-971-2153	France Cergy-Pontoise Ph: +33-1-3420-2122 Fx: +33-1-3420-2268	Lithuania Vilnius Ph: +370-5-213-1402 Fx: +370-5-213-1403	Romania Bucharest Ph: +40-31-860-2113	Turkey Istanbul Ph: +90-212-339-92-00 Fx: +90-212-339-92-02	
Czech Rep. & Slovakia Brno Ph: +420-541-162-112 Fx: +420-541-162-223	Germany Darmstadt Ph: +49-6151-607-1547 Fx: +49-6151-607-1219	Netherlands Den Bosch Ph: +31-73-6246-246 Fx: +31-73-6246-958	Russia Moscow Ph: +7-495-790-7902 Fx: +7-495-721-1894	U.A.E. Dubai Ph: +971 4 2117000 Fx: +971 4 2117001	

te.com

TE Connectivity, TE connectivity (logo), TE (logo), AMP CO, AMP NETCONNECT, AMPMODU, CORELINK, Every Connection Counts, FiberGuide, KRONE, KRONECTION, LightCrimp, LSA-PLUS, LSA PROFIL, MPOptimate, MRJ21, NETpodium, Quareo, QUICK FIT, Rapid Fiber, Sigma Link are trademarks. All other logos, products and/or company names referred to herein might be trademarks of their respective owners.

The information given herein, including drawings, illustrations and schematics which are intended for illustration purposes only, is believed to be reliable. However, TE Connectivity makes no warranties as to its accuracy or completeness and disclaims any liability in connection with its use. TE Connectivity's obligations shall only be as set forth in TE Connectivity's Standard Terms and Conditions of Sale for this product and in no case will TE Connectivity be liable for any incidental, indirect or consequential damages arising out of the sale, resale, use or misuse of the product. Users of TE Connectivity products should make their own evaluation to determine the suitability of each such product for the specific application.

© 2015 TE Connectivity Ltd. family of companies All Rights Reserved.

313956AE 02/15 Revision 5

EMEA PRODUCT CATALOG

TE Connectivity Broadband Network Solutions - EMEA

Please contact us at one of the regional offices shown above.

www.te.com/enterprise-eu
www.te.com/bns

Tyco Electronics Raychem bvba,
 a TE connectivity company.

X-ON Electronics

Largest Supplier of Electrical and Electronic Components

Click to view similar products for [Fibre Optic Connectors](#) category:

Click to view products by [TE Connectivity](#) manufacturer:

Other Similar products are found below :

[0004700001](#) [6100-R](#) [6313](#) [F709034706](#) [F709722200](#) [F709730000](#) [F718183204](#) [F727403500](#) [F727752800](#) [8119](#) [9440F20-27S-190](#) [944-120-6001](#) [9441F10SL-3S](#) [9444W28-21S](#) [9444W36-10S](#) [9446F10SL-4S](#) [9446W20-16S](#) [953-101-5310-P](#) [954-101-57202B](#) [A0270169](#) [12-9122](#) [12-5702](#) [AX101713](#) [AX102420](#) [AX103923](#) [AX104024](#) [AX104193](#) [AX104230](#) [AX104498](#) [AX104562](#) [AX105203-B25](#) [AX105205-S1](#) [EHSC2M](#) [181-011-126](#) [181-011-S](#) [181-057-126](#) [HRFC-R2\(40\)](#) [NKSOPBUY](#) [20500002116](#) [2064996-1](#) [20800001065](#) [2170](#) [9132](#) [2612](#) [2620](#) [9291](#) [9440F16-10S](#) [9440F20-18S](#) [9442W14S-10P](#) [9446F16-10S-190](#)