



Wire & Cable > Twisted Pair Cable



Cable Type: **Spec 55**

Voltage Rating: **600 VAC**

Insulation Material: **Modified Radiation Cross-linked ETFE Polymer**

Conductor Material: **Tin-Coated Copper**

Wire Size: **26 AWG**

Features

Product Type Features

Cable Type	Spec 55
------------	---------

Electrical Characteristics

Voltage Rating	600 VAC
----------------	---------

Body Features

Insulation Material	Modified Radiation Cross-linked ETFE Polymer
---------------------	--

Conductor Material	Tin-Coated Copper
--------------------	-------------------

Dimensions

Wire Size	26 AWG
-----------	--------

Usage Conditions

Operating Temperature Range	-65 – 150 °C[-85 – 302 °F]
-----------------------------	----------------------------

Product Compliance

[For compliance documentation, visit the product page on TE.com>](#)

EU RoHS Directive 2011/65/EU	Compliant
------------------------------	-----------

EU ELV Directive 2000/53/EC	Compliant
-----------------------------	-----------

China RoHS 2 Directive MIIT Order No 32, 2016	No Restricted Materials Above Threshold
---	---

EU REACH Regulation (EC) No. 1907/2006	
--	--



Current ECHA Candidate List: JUN 2020
(209)
Candidate List Declared Against: JUN 2020
(209)
Does not contain REACH SVHC

Halogen Content
Out of Scope - excluded from Halogen requirements

Solder Process Capability
Not applicable for solder process capability

Product Compliance Disclaimer

This information is provided based on reasonable inquiry of our suppliers and represents our current actual knowledge based on the information they provided. This information is subject to change. The part numbers that TE has identified as EU RoHS compliant have a maximum concentration of 0.1% by weight in homogenous materials for lead, hexavalent chromium, mercury, PBB, PBDE, DBP, BBP, DEHP, DIBP, and 0.01% for cadmium, or qualify for an exemption to these limits as defined in the Annexes of Directive 2011/65/EU (RoHS2). Finished electrical and electronic equipment products will be CE marked as required by Directive 2011/65/EU. Components may not be CE marked. Additionally, the part numbers that TE has identified as EU ELV compliant have a maximum concentration of 0.1% by weight in homogenous materials for lead, hexavalent chromium, and mercury, and 0.01% for cadmium, or qualify for an exemption to these limits as defined in the Annexes of Directive 2000/53/EC (ELV). Regarding the REACH Regulation, the information TE provides on SVHC in articles for this part number is based on the latest European Chemicals Agency (ECHA) 'Guidance on requirements for substances in articles' posted at this URL: <https://echa.europa.eu/guidance-documents/guidance-on-reach>

Compatible Parts

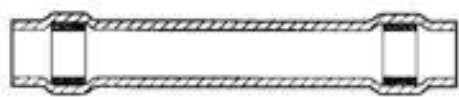

TE Model / Part # 650074-000
D-436-36

Customers Also Bought



TE Model / Part #228311-000
HEX40-AC-00-21-A9-1-DS



TE Model / Part #A01393-000
55PC0111-28-9

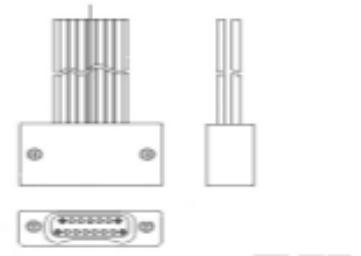

TE Model / Part #9-1589476-1
STM015SC2DX010N = WDUALOBE



TE Model / Part #BTH1-15-08-1-ZN
BTH1-15-08-1-ZN

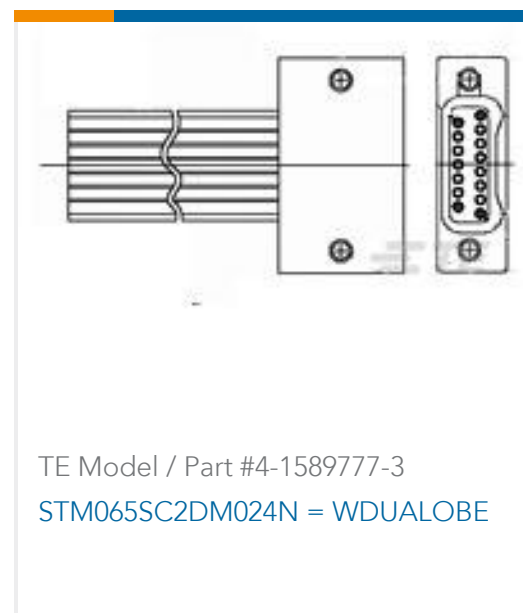
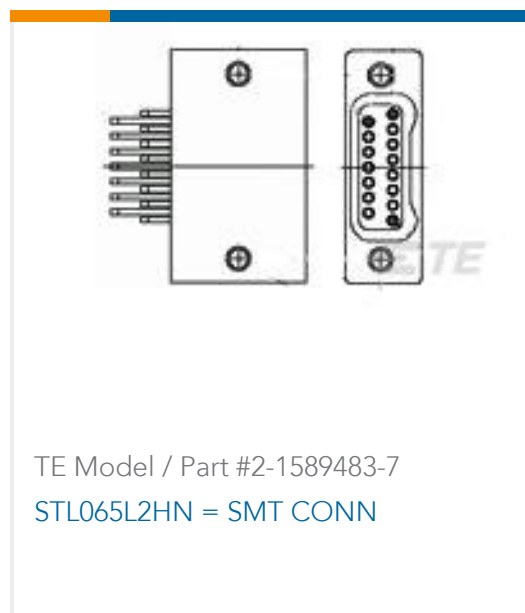
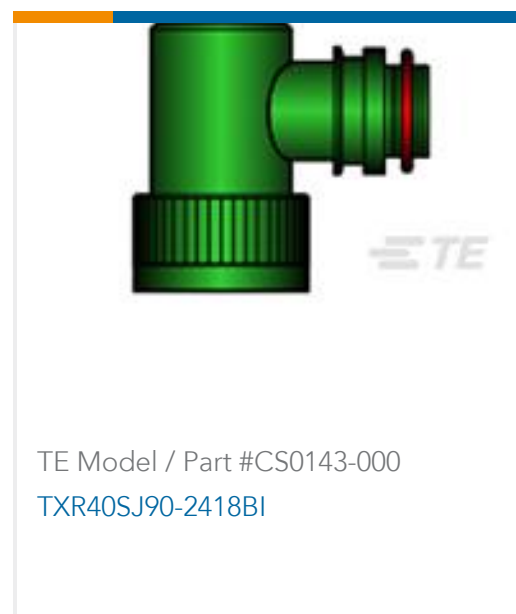
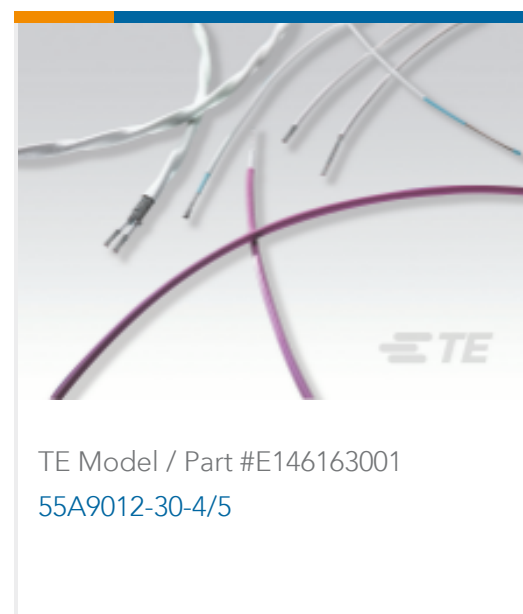
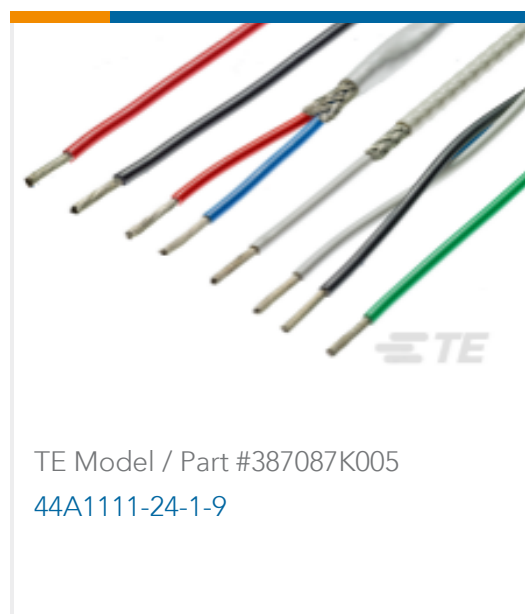

Documents

Product Drawings

[55A0131-26-0/2/6](#)

English

Datasheets & Catalog Pages

[1654025_Sec9_SPEC55](#)

English

Raychem Wire and Cable Quick Reference Guide

English

X-ON Electronics

Largest Supplier of Electrical and Electronic Components

Click to view similar products for [Multi-Conductor Cables](#) category:

Click to view products by [TE Connectivity](#) manufacturer:

Other Similar products are found below :

[8916-GRY-100](#) [8918-GRN/YEL-100](#) [8920-BRN-1000](#) [8920-RED-1000](#) [89907-LT-DEC/GRY-500](#) [CR3909-000](#) [CR3927-000](#) [01342.35T.01](#)
[01364.35T.01](#) [003201-000](#) [CS2885-000](#) [CS8782-000](#) [CS9912-000](#) [6200UE-NAT-U1000](#) [CTC-0062-20-9/5-9](#) [CTC-0062-22-9/5-9](#) [6304FE-](#)
[877-U500](#) [6309UE-877-1000](#) [6320UE-NAT-U1000](#) [644833-000](#) [6502FE 8771000](#) [6504UE-877-U1000](#) [CW9530-000](#) [CX6543-000](#) [CXA-](#)
[0066-20-4-9CS2973](#) [CXA-0078-16-1-9CS2405](#) [CXA-0078-22-4-9CS2405](#) [CXA-0078-24-4-9CS2405](#) [CXA-0140-16-6/9-9CS2405](#) [CY0660-](#)
[000](#) [706/2R-BLACK-EACH](#) [720451-000](#) [730859-000](#) [MCC-USB-4-250](#) [752687-000](#) [768146-000](#) [773159-000](#) [7934A-BLK-1000](#) [8125-](#)
[CHR-100](#) [8164-CHR-1000](#) [820457-000](#) [8205-CHR-1000](#) [8240-BLK-U1000](#) [82723-NAT-1000](#) [82907-NAT-500](#) [83003-YEL-500](#) [83005-](#)
[WHT-500](#) [83006-DK-GRN-100](#) [83008-WHT-1000](#) [83009-BLK-100](#)