

THIS DRAWING IS UNPUBLISHED. RELEASED FOR PUBLICATION
 © COPYRIGHT BY TYCO ELECTRONICS CORPORATION. ALL RIGHTS RESERVED.

LOC	DIST	REVISIONS					
FT	0	P	LTR	DESCRIPTION	DATE	DWN	APVD
			D	REVISED PER ECO-10-013614	13OCT10	HMR	CR

MATERIAL:
 HOUSING: THERMOPLASTIC, UL94V-0, BLACK.
 TERMINALS: BRIGHT TIN OVER COPPER ALLOY.
 SCREWS: #6-32 STEEL, ZINC PLATING W/ CLEAR CHROMATE.

ELECTRICAL:
 RATED CURRENT UL/CSA:
 CLASS C: 20A, 300V
 CLASS D: 5A, 600V
 WIRE RANGE: 12-22 AWG

MECHANICAL:
 RECOMMENDED TORQUE: 7 IN-LB.
 OPERATING TEMP.: 105°C MAX.

1 MARK WITH PERMANENT INK.

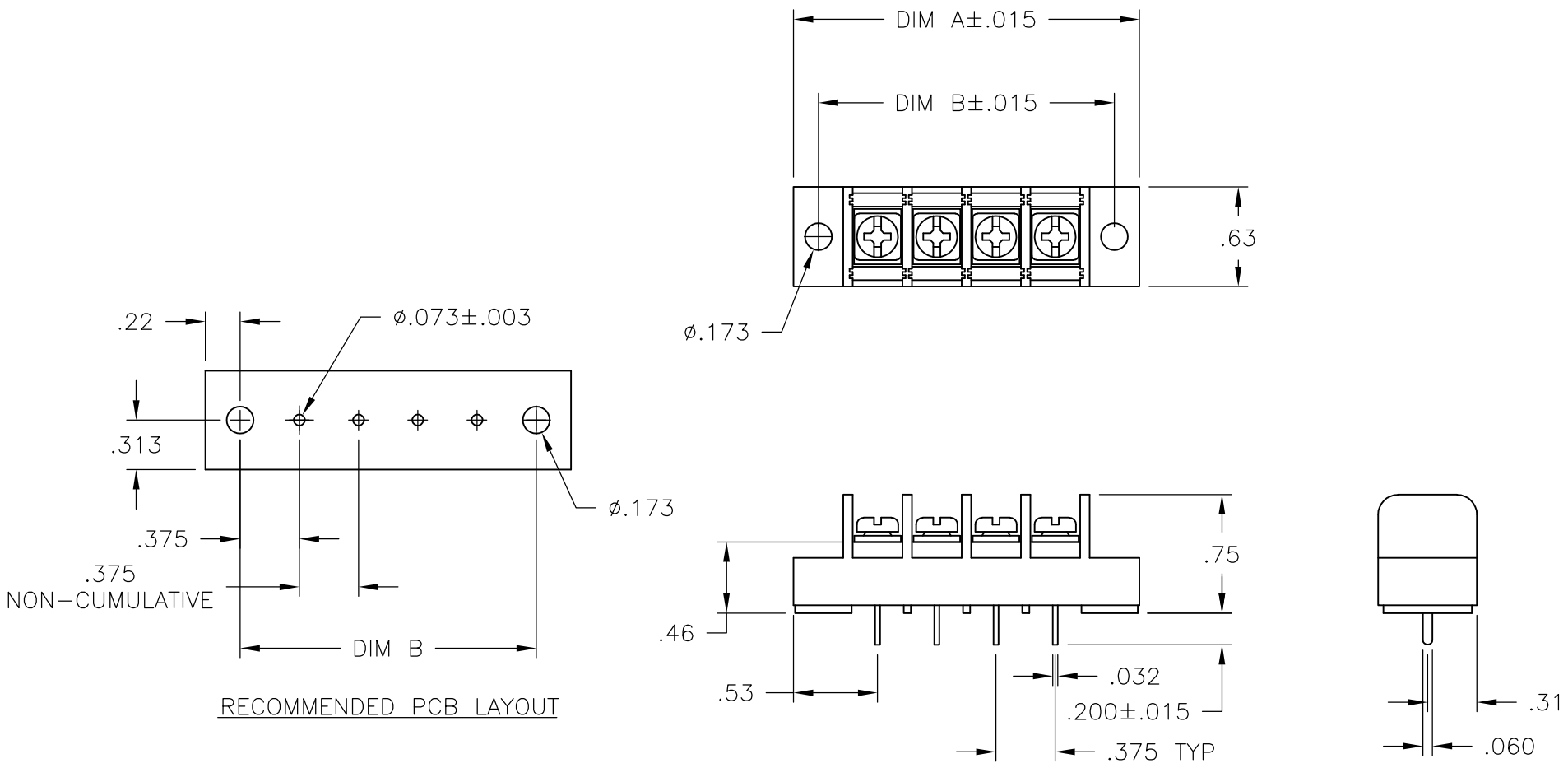

SEE FIGURE	9.000	9.314	23	JC6-P208-23	6-796985-5
	8.625	8.939	22	JC6-P208-22-224	1776344-1
SEE FIGURE	8.625	8.939	22	JC6-P208-22	6-796985-4
	8.250	8.564	21	JC6-P208-21	6-796985-3
SEE FIGURE	7.875	8.189	20	JC6-P208-20	6-796985-2
	7.500	7.814	19	JC6-P208-19	6-796985-1
SEE FIGURE	7.125	7.439	18	JC6-P208-18	2-796985-0
	6.750	7.064	17	JC6-P208-17	6-796985-0
SEE FIGURE	6.375	6.689	16	JC6-P208-16	5-796985-9
	6.000	6.314	15	JC6-P208-15	1-796985-9
SEE FIGURE	5.625	5.939	14	JC6-P208-14	5-796985-8
	5.250	5.564	13	JC6-P208-13	5-796985-7
SEE FIGURE	4.875	5.189	12	JC6-P208-12	5-796985-6
	4.500	4.814	11	JC6-P208-11	5-796985-5
SEE FIGURE	4.125	4.439	10	JC6-P208-10	5-796985-4
	3.750	4.064	9	JC6-P208-09	4-1437665-6
SEE FIGURE	3.375	3.689	8	JC6-P208-08	5-796985-3
	3.000	3.314	7	JC6-P208-07	5-796985-2
SEE FIGURE	2.625	2.939	6	JC6-P208-06	4-1437665-5
	2.250	2.564	5	JC6-P208-05	4-1437665-4
SEE FIGURE	1.875	2.189	4	JC6-P208-04-505	1776344-3
	1.875	2.189	4	JC6-P208-04-504	1776344-2
SEE FIGURE	1.875	2.189	4	JC6-P208-04-503	9-796985-7
	1.875	2.189	4	JC6-P208-04-500	9-796985-6
SEE FIGURE	1.875	2.189	4	JC6-P208-04	4-1437665-3
	1.500	1.814	3	JC6-P208-03-172	1-796985-8
SEE FIGURE	1.500	1.814	3	JC6-P208-03	4-1437665-2
	1.125	1.439	2	JC6-P208-02	4-1437665-1
	DIM. "B"	DIM. "A"	NO. OF POS.	CATALOG PART NO.	PART NUMBER

THIS DRAWING IS A CONTROLLED DOCUMENT.		DWN S. SCHLEGEL 5/7/03	Tyco Electronics Corporation Harrisburg, PA 17105	
DIMENSIONS: INCHES		CHK S. YODER 5/7/03	NAME JC6-P208-XX ASSEMBLY	
TOLERANCES UNLESS OTHERWISE SPECIFIED:		APVD S. YODER 5/7/03	PRODUCT SPEC -	
0 PLC ± - 1 PLC ± - 2 PLC ± .01 3 PLC ± - 4 PLC ± - ANGLES ± -		APPLICATION SPEC -	SIZE A3	CAGE CODE 00779
MATERIAL -		FINISH -	DRAWING NO G-4-1437665-1	
		WEIGHT -	RESTRICTED TO -	
		CUSTOMER DRAWING		SCALE NTS
		SHEET 1 OF 2		REV D

4

3

2

1

THIS DRAWING IS UNPUBLISHED. RELEASED FOR PUBLICATION
 © COPYRIGHT BY TYCO ELECTRONICS CORPORATION. ALL RIGHTS RESERVED.

LOC FT DIST 0

REVISIONS				
P	LTR	DESCRIPTION	DATE	APVD
-	-	SEE SHEET 1	-	-

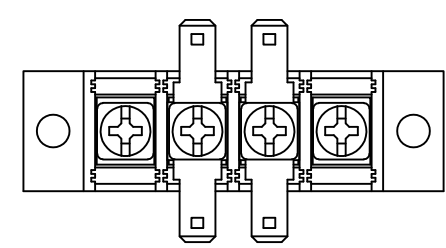
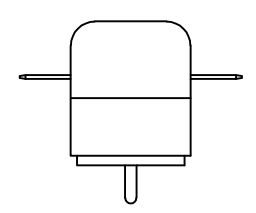
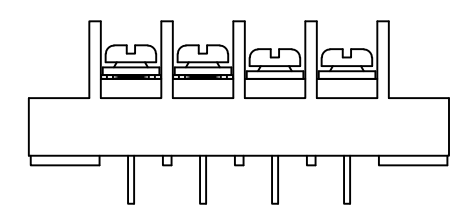
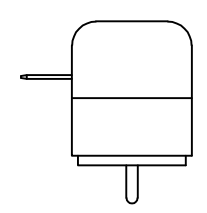
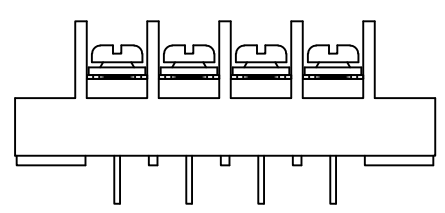
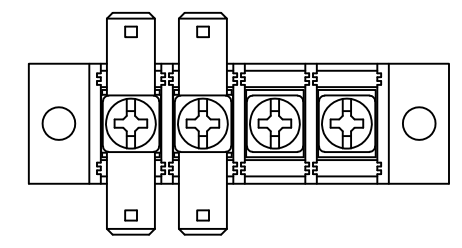
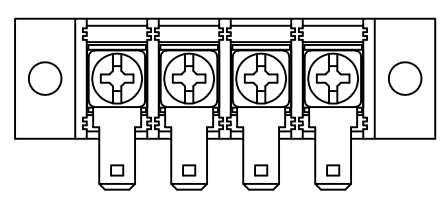
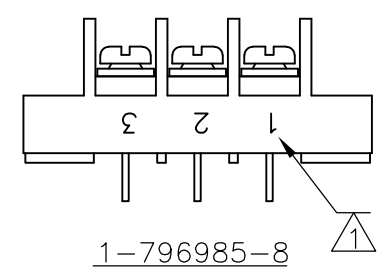
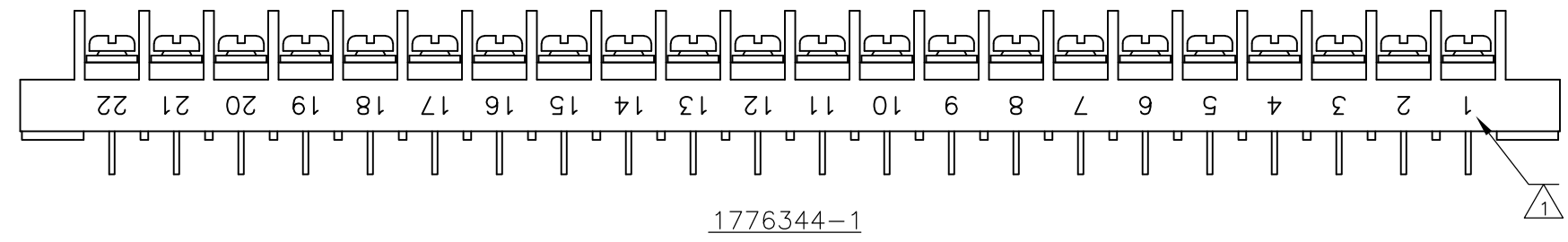

9-796985-7

1776344-2

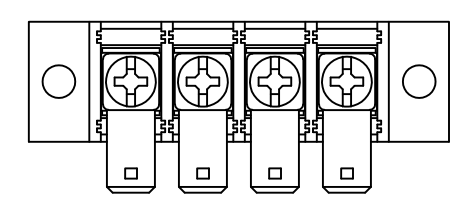
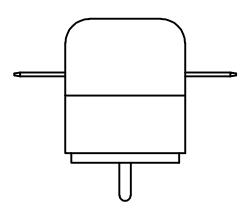
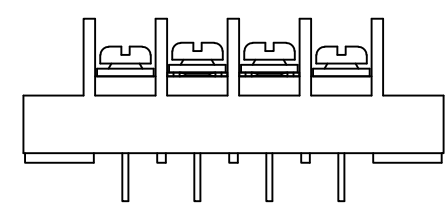

1776344-3

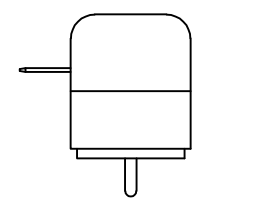
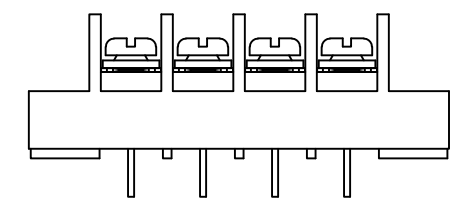

THIS DRAWING IS A CONTROLLED DOCUMENT.		DWN S. SCHLEGEL 5/7/03	Tyco Electronics Corporation Harrisburg, PA 17105	
DIMENSIONS: INCHES		CHK S. YODER 5/7/03		
TOLERANCES UNLESS OTHERWISE SPECIFIED:		APVD S. YODER 5/7/03	NAME	
0 PLC ± - 1 PLC ± - 2 PLC ± .01 3 PLC ± - 4 PLC ± - ANGLES ± -		PRODUCT SPEC -	JC6-P208-XX ASSEMBLY	
MATERIAL -		FINISH -	APPLICATION SPEC -	RESTRICTED TO -
		WEIGHT -	SIZE A3	CAGE CODE 00779
		CUSTOMER DRAWING	DRAWING NO. C-4-1437665-1	RESTRICTED TO -
		SCALE NTS	SHEET 2 OF 2	REV D

X-ON Electronics

Largest Supplier of Electrical and Electronic Components

Click to view similar products for [Barrier Terminal Blocks](#) category:

Click to view products by [TE Connectivity](#) manufacturer:

Other Similar products are found below :

[CR151D20104](#) [670A-RZ-15-KT20](#) [6C1N03](#) [6PCR-02](#) [6PCR-02-008](#) [6PCR-05-008](#) [6PCR-08-008](#) [6PCR-09-008](#) [6PCR-13-006](#) [6PCR-15-006](#) [6PCR-21-006](#) [6PCV-06-008](#) [6PCV-06-716](#) [6PCV-09-001](#) [6PCV-10-009](#) [6PCV-15-008](#) [6PCV-17-1206](#) [6PCV-20-323](#) [6PCV-20-720](#) [6PCV-30-006](#) [6STR-06-006](#) [6STR-08-006](#) [6STR-12-008](#) [6STR-13-006](#) [6STR-14-008](#) [6STR-16-008](#) [6STR-17-008](#) [6STR-21-008](#) [6STR-25-008](#) [6STR-27-008](#) [6STV-03-006](#) [6STV-03-008](#) [6STV-04-006](#) [6STV-09-006](#) [6STV-10-006](#) [6WWR-03-693](#) [6WWV-12-008](#) [72212603](#) [72504-C-50](#) [72506-C](#) [72507-C-50](#) [73203](#) [75505-C](#) [75505-C-50](#) [75510-C](#) [77010-50](#) [7C1N08](#) [812-GP-3/4ST-09](#) [8-1437402-5](#) [8-1437402-7](#)