

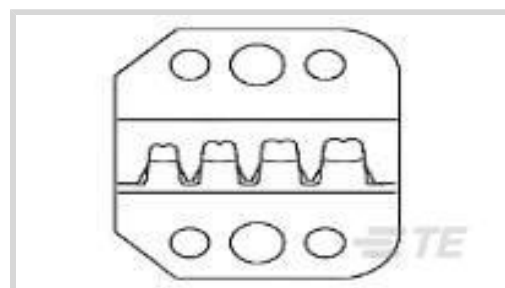

Application Tooling > Portable Crimp Tools



Tool Grade: **Commercial Crimp Tooling**

Ratchet Configuration: **Operator Releasable & Adjustable**

Die Sets Type: **Removable/Interchangeable**

Specification Type: **TE Product Specification (114-)**

TE Certification: **Upon Request for Fee**

Features

Other

Crimp Form-Wire Barrel Type	Open Barrel - F Crimp
Tool Grade	Commercial Crimp Tooling
Ratchet Configuration	Operator Releasable & Adjustable
Die Sets Type	Removable/Interchangeable
Specification Type	TE Product Specification (114-)
TE Certification	Upon Request for Fee
Power Technology Type	Battery, Electric, Manual
Tooling Type	Standard Die Envelope (SDE) Die Set

Product Compliance

[For compliance documentation, visit the product page on TE.com>](#)

EU RoHS Directive 2011/65/EU	Out of Scope
EU ELV Directive 2000/53/EC	Out of Scope
China RoHS 2 Directive MIIT Order No 32, 2016	Not reviewed for China RoHS compliance
EU REACH Regulation (EC) No. 1907/2006	Current ECHA Candidate List: JAN 2021 (211) Candidate List Declared Against: JAN 2021 (211) Does not contain REACH SVHC
Halogen Content	Low Halogen - Br, Cl, F, I < 900 ppm per

homogenous material. Also BFR/CFR/PVC Free







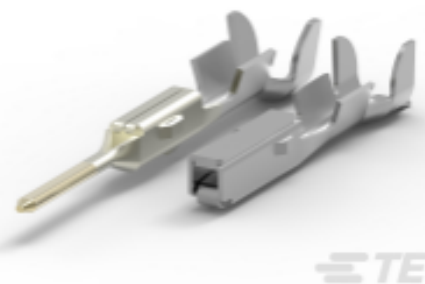

Solder Process Capability

Not applicable for solder process capability

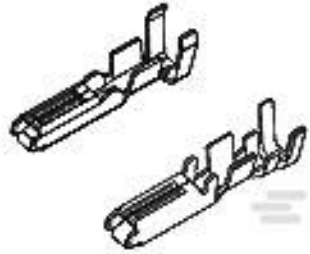
Product Compliance Disclaimer

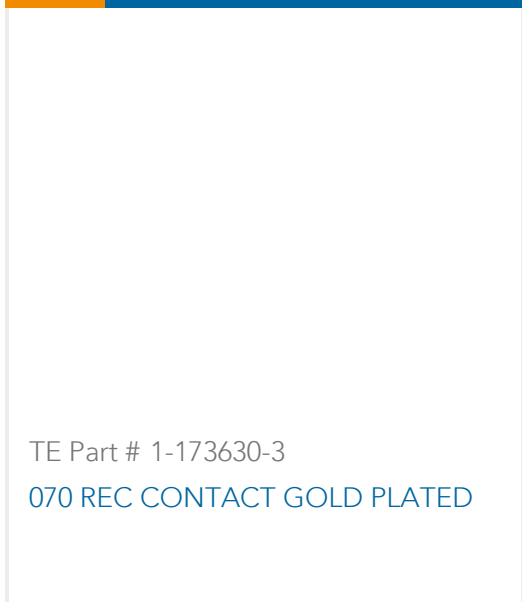
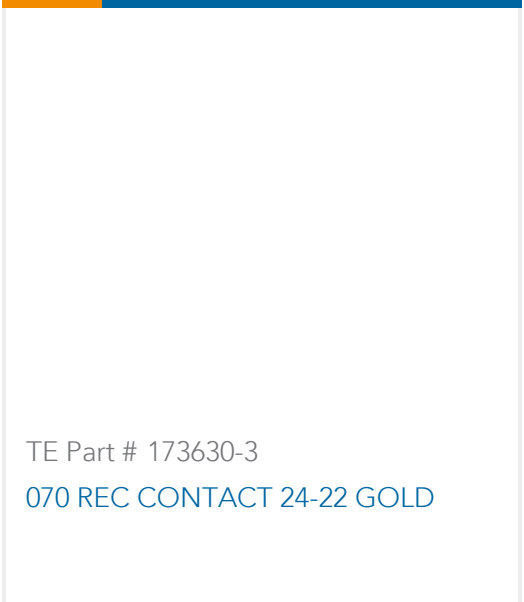
This information is provided based on reasonable inquiry of our suppliers and represents our current actual knowledge based on the information they provided. This information is subject to change. The part numbers that TE has identified as EU RoHS compliant have a maximum concentration of 0.1% by weight in homogenous materials for lead, hexavalent chromium, mercury, PBB, PBDE, DBP, BBP, DEHP, DIBP, and 0.01% for cadmium, or qualify for an exemption to these limits as defined in the Annexes of Directive 2011/65/EU (RoHS2). Finished electrical and electronic equipment products will be CE marked as required by Directive 2011/65/EU. Components may not be CE marked. Additionally, the part numbers that TE has identified as EU ELV compliant have a maximum concentration of 0.1% by weight in homogenous materials for lead, hexavalent chromium, and mercury, and 0.01% for cadmium, or qualify for an exemption to these limits as defined in the Annexes of Directive 2000/53/EC (ELV). Regarding the REACH Regulation, the information TE provides on SVHC in articles for this part number is based on the latest European Chemicals Agency (ECHA) 'Guidance on requirements for substances in articles' posted at this URL: <https://echa.europa.eu/guidance-documents/guidance-on-reach>

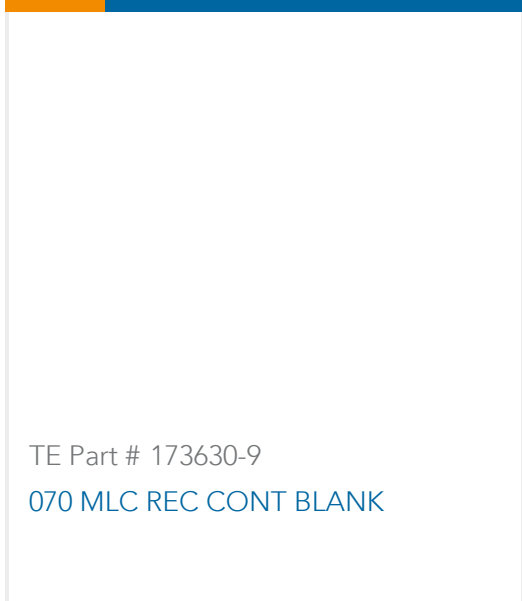
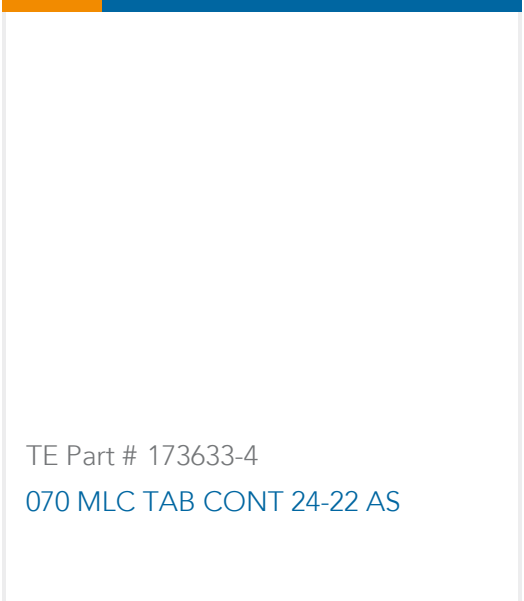
Compatible Parts

 <p>TE Part # CAT-M9194-T273 MULTILOCK, RECEPTACLE AND TAB</p>	 <p>TE Part # 175026-1 070 REC CONTACT L.P 24-22</p>	 <p>TE Part # 175026-7 070 MLC REC CONT LP</p>	 <p>TE Part # 1-173630-0 070 MLC REC CONT 24-22 AS</p>
 <p>TE Part # 1-173630-3 070 REC CONTACT GOLD PLATED</p>	 <p>TE Part # 173630-3 070 REC CONTACT 24-22 GOLD</p>	 <p>TE Part # 173630-4 070 TYPE REC CONT. 24-22 BLANK</p>	 <p>TE Part # 173630-8 070 MLC REC CONT GOLD</p>
 <p>TE Part # 173630-9 070 MLC REC CONT BLANK</p>	 <p>TE Part # 173633-4 070 MLC TAB CONT 24-22 AS</p>	 <p>TE Part # 175029-1 070 TAB CONTACT L.P 24-22</p>	 <p>TE Part # 175026-6 070 MLC REC CONT LP</p>



Customers Also Bought

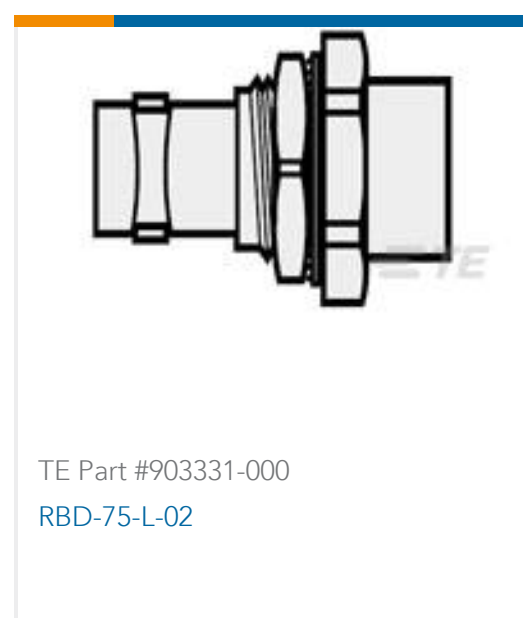

Documents

Datasheets & Catalog Pages

[1-1773865-2_1015_Commercial Manual Hand Tools](#)

English

[Crimp Term Whitepaper-Use the Right Tool 1-1773953-1](#)

English

[CRIMPING WHERE FORM MEETS FUNCTION](#)

English

[Bottoming Dies](#)



English

Instruction Sheets

Instruction Sheet (U.S.)

English

X-ON Electronics

Largest Supplier of Electrical and Electronic Components

Click to view similar products for [Punches & Dies](#) category:

Click to view products by [TE Connectivity](#) manufacturer:

Other Similar products are found below :

[58510-1](#) [63454-1601](#) [63457-0056](#) [63457-3401](#) [730-5/8](#) [730BB-1-3/8](#) [PV-670508-001](#) [1328](#) [1338](#) [13782656](#) [13782673](#) [13782686](#) [AR-24](#)
[1528-TL](#) [1583609-1](#) [1720](#) [1762951-1](#) [2063500-2](#) [19031-0168](#) [AR-20](#) [CD5-8](#) [313336-3](#) [11-19-3122](#) [539663-1](#) [63446-2241](#) [TL-18](#)
[0634451912](#) [1762674-1](#) [63454-0123](#) [68240-1](#) [68247-1](#) [734252](#) [313183-1](#) [PA2029](#) [119174-001](#) [23846-1](#) [11-40-5342](#) [68010-2](#) [690370015](#)
[730BB-1-1/8](#) [730BB-1-1/16](#) [19032-0048](#) [63465-0023](#) [11-40-4438](#) [63457-0041](#) [2906252-01](#) [19032-0202](#) [11-11-0054](#) [11-11-0052](#) [19813-](#)
[5041](#)