

Sin nuestra autorización, queda terminantemente prohibida la reproducción total o parcial de este documento, así como su uso indebido y/o su exhibición o comunicación a terceros. De los infractores se exigirá el correspondiente resarcimiento de daños y perjuicios. Se reserva todos los derechos para el caso de la concesión de patente de invención o el registro de Modelo Industrial.

Weitergabe sowie Vervielfältigung dieser Unterlage, Verwertung und Mitteilung ihres Inhalts sind nicht gestattet, soweit nicht ausdrücklich zugestanden. Zuwiderhandlungen verpflichten zu Schadenersatz. Alle Rechte für den Fall der Patenterteilung oder GM-Eintragung vorbehalten.

Copying of this document, and giving it to others and the use or communication of the contents thereof, are forbidden without express authority. Offenders are liable to the payment of damages. All rights are reserved in the event of the grant of a patent or the registration of a utility model or design.

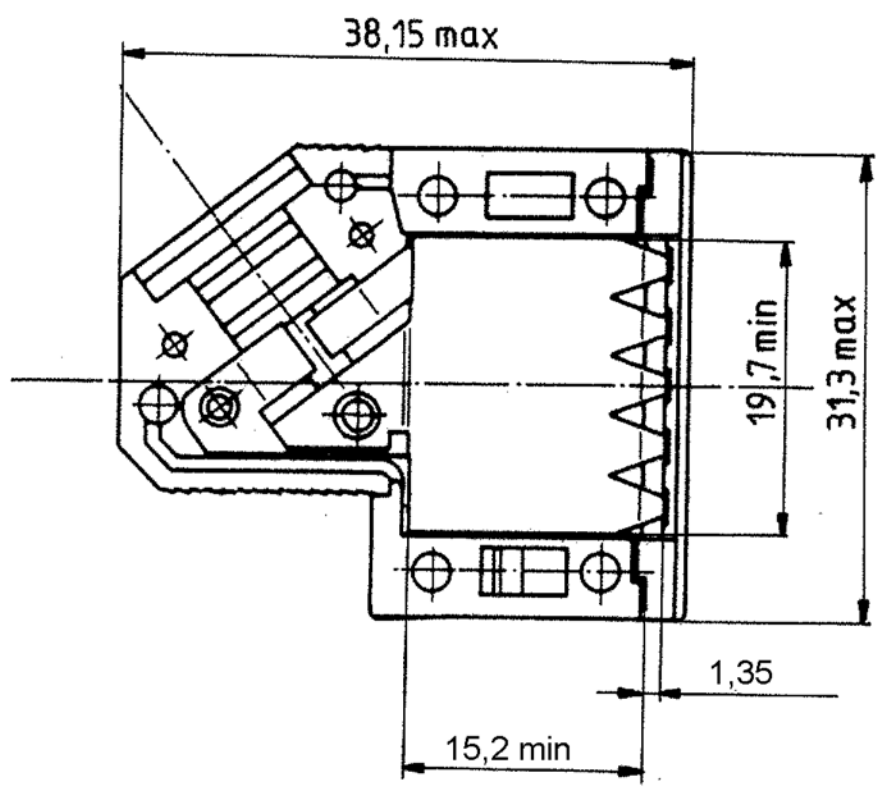

1 FOR PLASTIC PARTS (POS. 1 AND 2):  
 - LENGTHS: DIN 16901/130,  
 - ANGLES, FORMS: DIN 7168-m, R,  
 FOR METAL PARTS (POS. 3 AND 4): DIN 7168-m,  
 FOR SCREWS (POS. 5 AND 6): DIN 7981 F-H.

P/N 9 contacts version: V42254-A6000-G\*09

	Maßstab	
	TE Connectivity	
	D-Sub housing shielded 9 contacts	
	Datum: 30.08.88 Bearb: De Petter Geor: PD Com P&SE Norm:	

C	ECO-12-008266	28AUG12	CWR
Zust	Mitteilung	Datum	Name

TOLERANCES UNLESS OTHERWISE SPECIFIED:

V42254-A6000-G\*\*\*-\*-27

customer drawing number: C 1393738-1

page 1+ of 6

Si esta copia o versión autorizada queda permanentemente prohibida la reproducción total o parcial de este documento, así como su uso indebido y/o su exhibición o comunicación a terceros. De los infractores se exigirá el correspondiente resarcimiento de daños y perjuicios. Se reserva todos los derechos para el caso de la concesión de patente de invención o el registro de Modelo Industrial.



Weitergabe sowie Vervielfältigung dieses Unterbauelementes und Mitteilung ihres Inhalts ist nicht gestattet, soweit nicht ausdrücklich zugestanden. Zuwiderhandlung kann strafrechtliche und zivilrechtliche Ansprüche zur Schadensersatzung auslösen. Alle Rechte vorbehalten. Fall der Patenterteilung oder GM Untertaugung vorbehalten.

Copying of this document and giving it to others and the use or communication of the contents thereof are forbidden without express authority. Offenders are liable to the payment of damages. All rights are reserved in the event of the grant of a patent or the registration of a utility model or design.

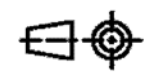

housing		dimension									
P/N	No. of contacts	A	B	C	D	E	F	G	H	J	K
V42254-A6000-											
G × 15	15					28	39,62		R3	14,5	R4,5
G × 25	25	13	14	1	7,5	41,8	53,52	6,5	R4	16	R5,5
G × 37	37					58,25	69,8				
G × 50	50	16	17,5	1,5	9,5	55,78	67,41	9,5	R5,5	20,6	R7

2) only for the 37 contacts version  
 1) tape only for the 15 to 37 contacts versions  
 drawn is the 25 contacts version

				Maßstab	
				TE Connectivity	
		Datum: 30.08.88 Bearb. De Petter Gepr. PD Com P&SE Norm.:		D-Sub housing shielded 15 to 50 contacts	
		TOLERANCES UNLESS OTHERWISE SPECIFIED:		<b>V42254-A6000-G***-*-27</b>	
		C SEE SHEET 1		page 2+	
				customer drawing number: C 1393738-1	
Zust.	Mitteilung	Datum	Name		

V 4 2 2 5 4 - A 6 0 0 \* - G \* \* \*

Housing type  
G plastic housing, shielded

Marking and colour of the housing

1	TE-marking, grey
2	without marking, grey
3	TE-marking, black
4	without marking, black

Packaging	wire diameter	No. of contacts - housing size						
		0	1	2	3	4		
set 1)	9-14,5	4-8	4-6	6-8		4-8	09	9 contact - housing size 1
200 2)	9-12	5-10	5-8	8-10		5-10	15	15 contacts - housing size 2
200 2)	12-14,5	5-11	5-8,5	8,5-1		5-11	25	25 contacts - housing size 3
200 2)		6-11	6-8	8-10	10-11	6-11	37	37 contacts - housing size 4
200 2)		9-14,5	9-12			9-14,5	50	50 contacts - housing size 5

1) per set, in blister  
 - 9 and 15 contacts : 25  
 - 25, 37 and 50 contacts : 15  
 2) loose pieces, in cardboard : 200



TE Connectivity

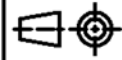

LOC DIMENSIONS  
GW IN MM

SCALE WEIGHT

MATERIAL

DATE 30.08.88  
 NAME De Petter  
 DEP. PD Com P&SE  
 EC  
 TOLERANCE UNLESS SPECIFIED OTHERWISE

NAME D-Sub Housing  
 shielded  
 DWG NO. V42254-A6000-G\*\*\*-\*-27  
 SHT. 3+

REV. CHANGE ORDER DATE APP. customer drawing number: C 1393738-1 OF 6

THIS INFORMATION IS CONFIDENTIAL AND PROPRIETARY TO TYCO ELECTRONICS CORPORATION AND ITS WORLDWIDE SUBSIDIARIES AND AFFILIATES. IT MAY NOT BE DISCLOSED TO ANYONE, OTHER THAN TYCO ELECTRONICS PERSONNEL, WITHOUT WRITTEN AUTHORIZATION FROM TYCO ELECTRONICS CORPORATION, HARRISBURG, PENNSYLVANIA USA.

PROPRIETARY:

A

B

C

D

E

F

Active part numbers. Contact Tyco Electronics for other configuration availability

Old Part Number	TE Part Number	
V42254-A6000-G109	1393738-1	
V42254-A6000-G115	1393738-2	
V42254-A6000-G125	1393738-3	
V42254-A6000-G137	1393738-4	
V42254-A6000-G150	1393738-5	
V42254-A6000-G209	<del>1393738-6</del>	OBSOLETE
V42254-A6000-G309	<del>1393738-7</del>	OBSOLETE
V42254-A6000-G315	<del>1393738-8</del>	OBSOLETE
V42254-A6000-G325	1393738-9	SUPERSEDED BY 1393738-1
V42254-A6001-G109	4-1393738-2	OBSOLETE
V42254-A6001-G125	4-1393738-4	SUPERSEDED BY 6-1393738-1
V42254-A6001-G309	4-1393738-5	SUPERSEDED BY 1-1393739-9
V42254-A6001-G315	4-1393738-6	SUPERSEDED BY 6-1393738-7
V42254-A6002-G109	5-1393738-0	OBSOLETE
V42254-A6002-G125	5-1393738-2	SUPERSEDED BY 6-1393738-1
V42254-A6003-G137	5-1393738-7	SUPERSEDED BY 6-1393738-2
V42254-A6004-G109	5-1393738-9	
V42254-A6004-G115	6-1393738-0	
V42254-A6004-G125	6-1393738-1	
V42254-A6004-G137	6-1393738-2	
V42254-A6004-G150	6-1393738-3	
V42254-A6004-G209	6-1393738-4	SUPERSEDED BY 5-1393738-9
V42254-A6004-G215	6-1393738-5	OBSOLETE
V42254-A6004-G225	6-1393738-6	OBSOLETE
V42254-A6004-G309	1-1393739-9	
V42254-A6004-G315	6-1393738-7	
V42254-A6004-G325	2-1393739-0	OBSOLETE
V42254-A6004-G337	2-1393739-1	SUPERSEDED BY 6-1393738-2
V42254-A6004-G350	2-1393739-2	SUPERSEDED BY 6-1393738-3
V42254-A6004-G409	6-1393738-8	OBSOLETE
V42254-A6004-G415	6-1393738-9	OBSOLETE
V42254-A6004-G437	7-1393738-1	OBSOLETE

THIS INFORMATION IS CONFIDENTIAL AND PROPRIETARY TO TYCO ELECTRONICS CORPORATION AND ITS WORLDWIDE SUBSIDIARIES AND AFFILIATES. IT MAY NOT BE DISCLOSED TO ANYONE, OTHER THAN TYCO ELECTRONICS PERSONNEL, WITHOUT WRITTEN AUTHORIZATION FROM TYCO ELECTRONICS CORPORATION, HARRISBURG, PENNSYLVANIA USA.



TE Connectivity		SCALE		WEIGHT	
LOC DIMENSIONS IN MM		MATERIAL			
DATE	30.08.88	NAME			
NAME	De Petter	D-Sub Housing			
DEP.	PD Com P&SE	shielded			
EC		DWG NO.			
TOLERANCE UNLESS SPECIFIED OTHERWISE		SHT. 4+			
V42254-A6000-G***-*-27		OF 6			
REV.	CHANGE ORDER	DATE	APP.	Customer Drawing: C 1393738-1	

PROPRIETARY:

PROPRIETARY: THIS INFORMATION IS CONFIDENTIAL AND PROPRIETARY TO TYCO ELECTRONICS CORPORATION AND ITS WORLDWIDE SUBSIDIARIES AND AFFILIATES. IT MAY NOT BE DISCLOSED TO ANYONE, OTHER THAN TYCO ELECTRONICS PERSONNEL, WITHOUT WRITTEN AUTHORIZATION FROM TYCO ELECTRONICS CORPORATION, HARRISBURG PENNSYLVANIA USA

V 4 2 2 5 4 - A 6 1 \* \* - L 1

Technical data		
	contact tube outer diameter ±0.1	for shield braiding outer diameter
04	4	2.0 to 2.7
05	5	2.8 to 3.7
06	6	3.8 to 4.7
07	7	4.8 to 5.7
08	8	5.8 to 6.7
09	9	6.8 to 7.7
10	10	7.8 to 8.7
11	11	8.8 to 9.7
12	12	9.8 to 10.7
13	13	10.8 to 11.7
14	14	11.8 to 12.7
15	15	12.8 to 13.7

Active part numbers. Contact Tyco Electronics for other configuration availability

Old Part Number	TE Part Number	
V42254-A6104-L1	3-1393561-2	OBSOLETE
V42254-A6105-L1	3-1393561-3	
V42254-A6106-L1	3-1393561-4	
V42254-A6107-L1	3-1393561-5	
V42254-A6108-L1	3-1393561-6	
V42254-A6109-L1	3-1393561-9	
V42254-A6110-L1	4-1393561-0	
V42254-A6111-L1	<del>4-1393561-1</del>	OBSOLETE
V42254-A6112-L1	4-1393561-2	
V42254-A6113-L1	4-1393561-3	OBSOLETE
V42254-A6114-L1	4-1393561-4	OBSOLETE
V42254-A6115-L1	5-1393502-9	OBSOLETE

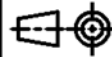
APPLICABLE SPEC.:				FINISH			
 <b>TE Connectivity</b>				DIMENSIONS APPLY		PLATING	
				SCALE		WEIGHT	
 DIMENSIONS IN MM				MATERIAL			
DATE 30.08.88 NAME De Petter DEP. PD Com P&SE EC				NAME D-Sub Housing			
TOLERANCE UNLESS SPECIFIED OTHERWISE				accessories: contact tubes			
REV. C SEE SHEET 1 CHANGE ORDER DATE APP. customer drawing number: C 1393738-1				DWG NO. V42254-A6000-G***-*-27		SHT. 5+ OF 6	



PROPRIETARY: THIS INFORMATION IS CONFIDENTIAL AND PROPRIETARY TO TYCO ELECTRONICS CORPORATION AND ITS WORLDWIDE SUBSIDIARIES AND AFFILIATES. IT MAY NOT BE DISCLOSED TO ANYONE, OTHER THAN TYCO ELECTRONICS PERSONNEL, WITHOUT WRITTEN AUTHORIZATION FROM TYCO ELECTRONICS CORPORATION, HARRISBURG PENNSYLVANIA USA

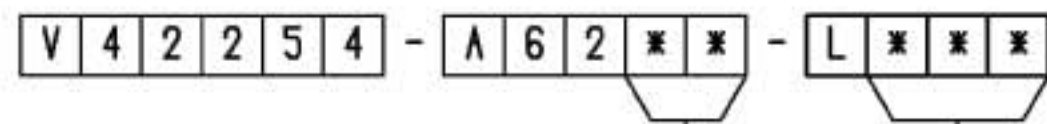

		Technical Data	
		bushing inner diameter ±0.2	cable outer diameter
00	1)2)	/	/
05	3)	5	4.2 to 4.9
06	3)	6	5.0 to 5.9
07	3)	7	6.0 to 6.9
08	3)	8	7.0 to 7.9
09	3)	9	8.0 to 8.9
10	2)	10	9.0 to 9.9
11	2)	11	10.0 to 10.9
12	4)	12	11.0 to 11.9
13	4)	13	12.0 to 12.9
14	4)	14	13.0 to 13.9
15	4)	15	14.0 to 14.9

	contacts	colour
1	9 to 37	grey
50	50	grey
100	9 to 37	black
150	50	black

Active part numbers. Contact Tyco Electronics for other configuration availability

Old Part Number	TE Part Number	
V42254-A6200-L 1	4-1393561-5	OBSOLETE
V42254-A6200-L 50	4-1393561-6	
V42254-A6200-L100	5-1393502-1	OBSOLETE
V42254-A6200-L150	5-1393502-2	OBSOLETE
V42254-A6205-L 1	4-1393561-7	
V42254-A6205-L100	4-1393561-8	
V42254-A6206-L 1	4-1393561-9	
V42254-A6206-L100	5-1393561-0	
V42254-A6207-L 1	5-1393561-1	
V42254-A6207-L100	5-1393561-4	OBSOLETE
V42254-A6208-L 1	5-1393561-5	
V42254-A6208-L100	5-1393561-6	OBSOLETE
V42254-A6209-L 1	5-1393561-7	
V42254-A6209-L100	5-1393561-8	
V42254-A6210-L 1	5-1393561-9	
V42254-A6210-L 50	6-1393561-0	OBSOLETE
V42254-A6210-L100	6-1393561-1	OBSOLETE
V42254-A6210-L150	5-1393502-3	OBSOLETE
V42254-A6211-L 1	6-1393561-2	
V42254-A6211-L 50	6-1393561-3	OBSOLETE
V42254-A6211-L100	5-1393502-4	OBSOLETE
V42254-A6211-L150	5-1393502-5	OBSOLETE
V42254-A6212-L 50	6-1393561-4	OBSOLETE
V42254-A6212-L150	5-1393502-6	OBSOLETE
V42254-A6213-L 50	6-1393561-5	OBSOLETE
V42254-A6213-L150	5-1393502-7	OBSOLETE
V42254-A6214-L 50	6-1393561-6	OBSOLETE
V42254-A6214-L150	5-1393502-8	OBSOLETE
V42254-A6215-L 50	8-1393501-5	OBSOLETE
V42254-A6215-L150	6-1393561-7	OBSOLETE

- 4) only for 50 contacts
- 3) only for 9 to 37 contacts
- 2) for 9 to 50 contacts
- 1) Blank bushing

APPLICABLE SPEC.				FINISH			
				DIMENSIONS APPLY		PLATING	
				SCALE		WEIGHT	
				MATERIAL			
DATE: 30.08.88 NAME: De Petter DEP.: PD Com P&SE EC				NAME: D-Sub Housing accessories: cable bushings			
TOLERANCE UNLESS SPECIFIED OTHERWISE				DWG. NO.		SHT. 6	
c SEE SHEET 1 REV. CHANGE ORDER				V42254-A6000-G***-*-27		OF 6	
DATE				customer drawing number: C 1393738-1			

## X-ON Electronics

Largest Supplier of Electrical and Electronic Components

*Click to view similar products for [D-Sub Backshells](#) category:*

*Click to view products by [TE Connectivity](#) manufacturer:*

Other Similar products are found below :

[600X54009X](#) [M85049/6-38N](#) [M85049/86-12N03](#) [M85049/90-13P03](#) [70.350.0636.4](#) [70.350.2435.1](#) [72.350.1035.2](#) [72.352.2435.1](#)  
[73.359.4035.3](#) [829472-1](#) [PCS-E20W](#) [970-015-040R011](#) [971-009-030R121](#) [971-009-040R011](#) [971-015-040R011](#) [DPH-B-003](#) [1437013-9](#)  
[1484402-8](#) [156-3025-EX](#) [16-500800](#) [165X02659X](#) [165X03329A](#) [165X03399A](#) [165X10259X](#) [165X11759X](#) [165X11889X](#) [165X11899X](#)  
[165X13019X](#) [165X13029X](#) [165X13169X](#) [165X13199X](#) [165X13239X](#) [165X13389X](#) [165X13489X](#) [165X14219X](#) [165X14429X](#)  
[165X14449X](#) [165X17409X](#) [165X17439X](#) [165X17569X](#) [165X17599X](#) [165X17609X](#) [165X17889X](#) [165X17979X](#) [L171373](#) [971-025-](#)  
[030R121](#) [300X10989X](#) [165X02609X](#) [165X02639X](#) [165X02689X](#)