

LOC		DIST		REVISIONS			
P	LTR	DESCRIPTION	DATE	DWN	APVD		
E		REVISED PER ECR-21-100678	08APR2021	SS	VS		
F		REVISED PER ECR-20-100915	28APR2021	JP	VS		

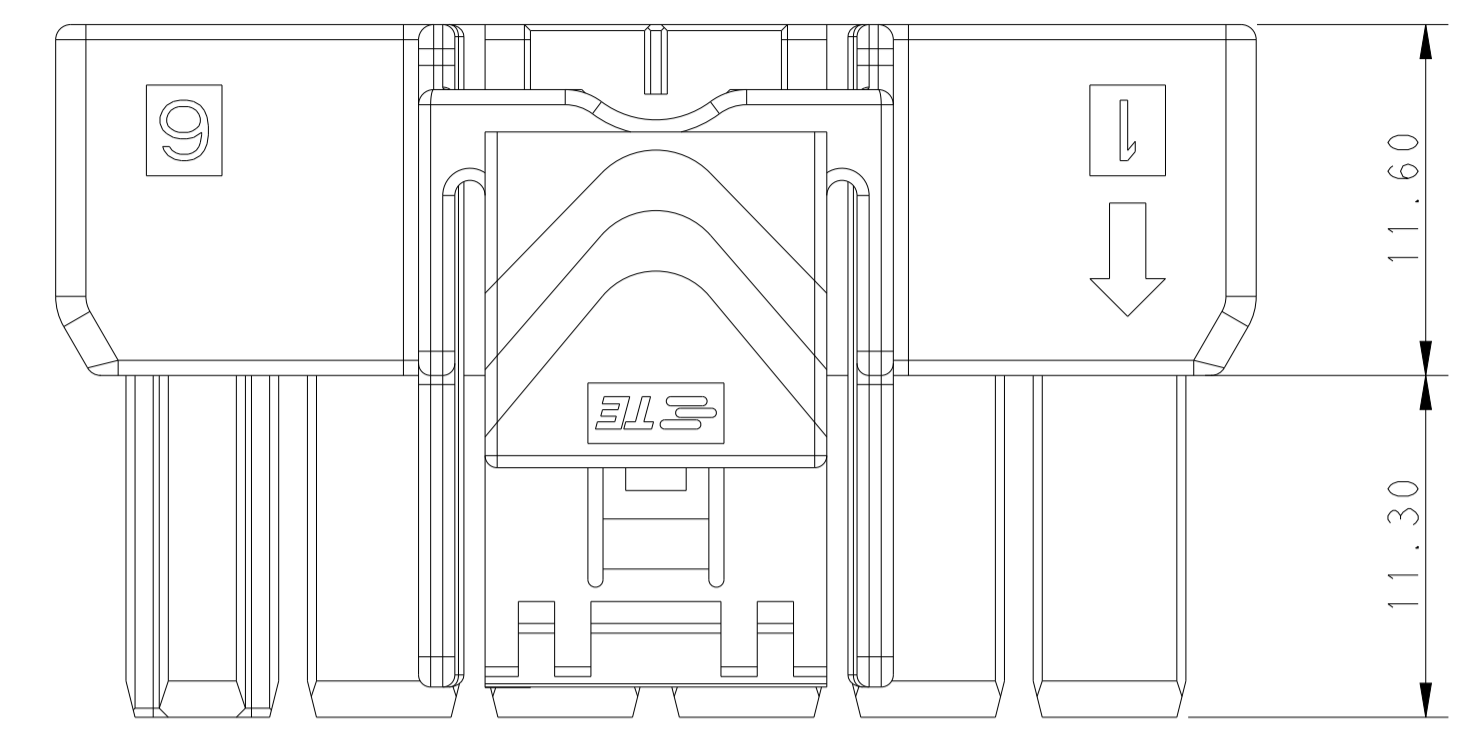

POS.	DIM. A
2*6	39.70
2*5	33.70
2*4	27.70
2*3	21.70

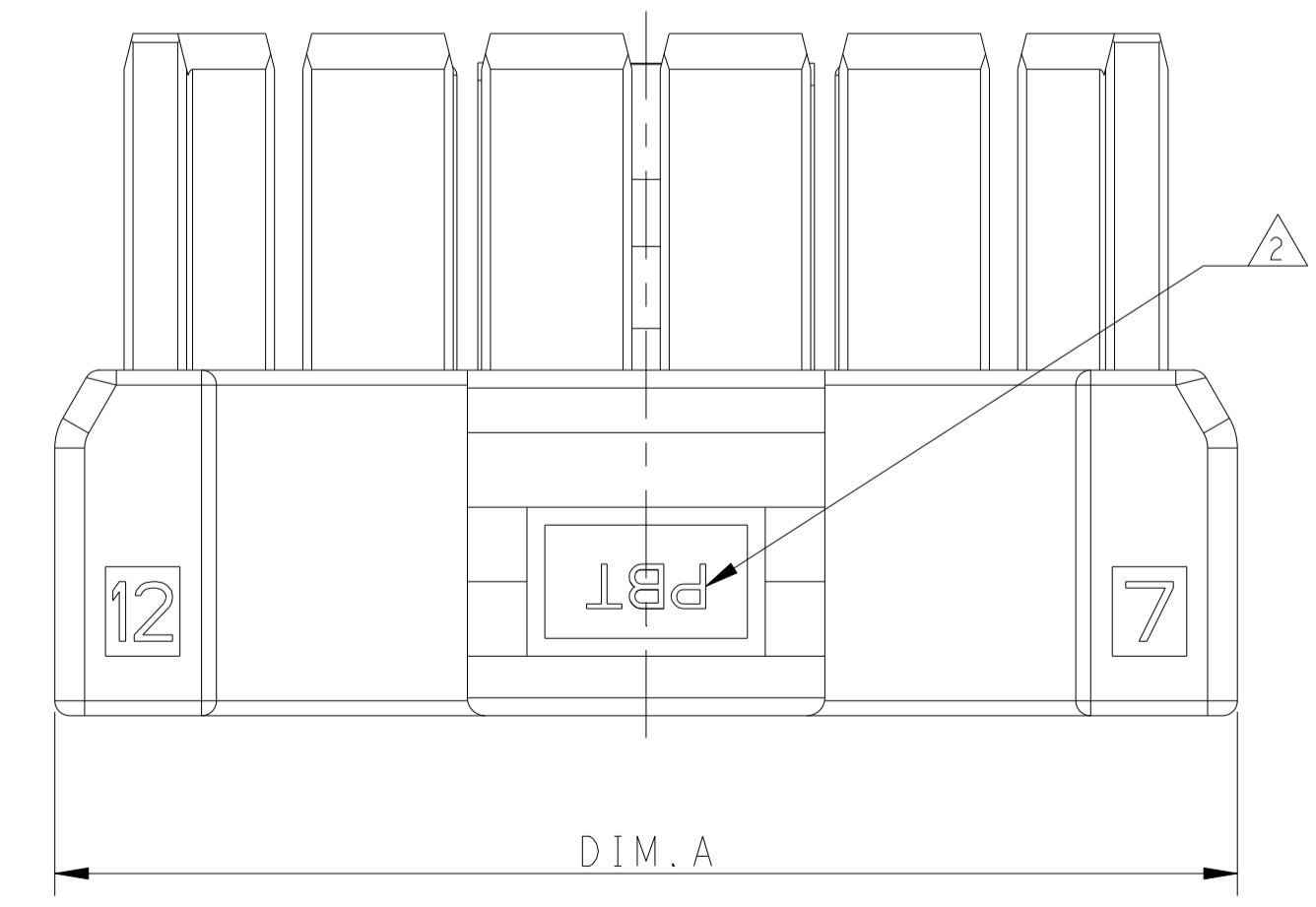
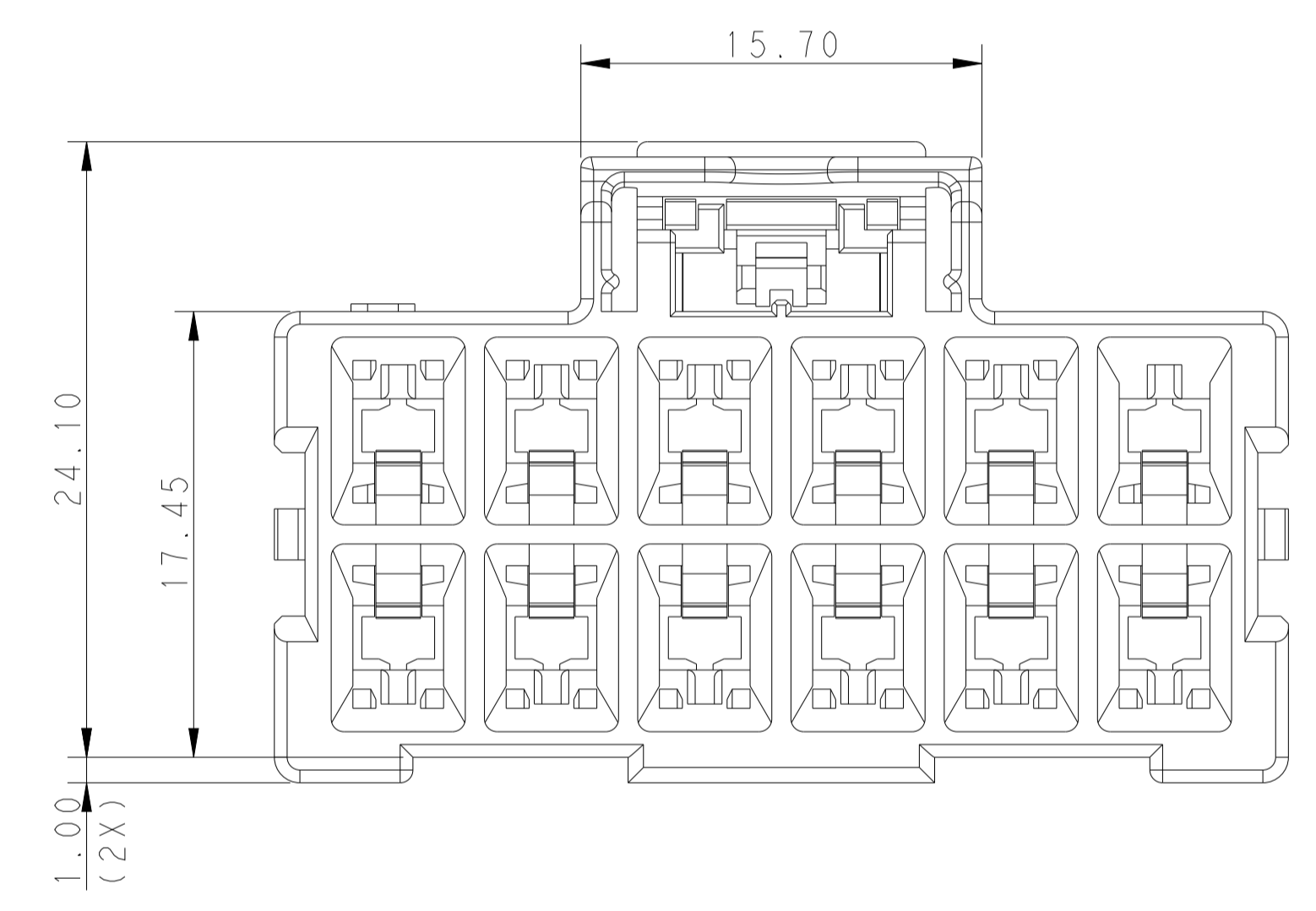
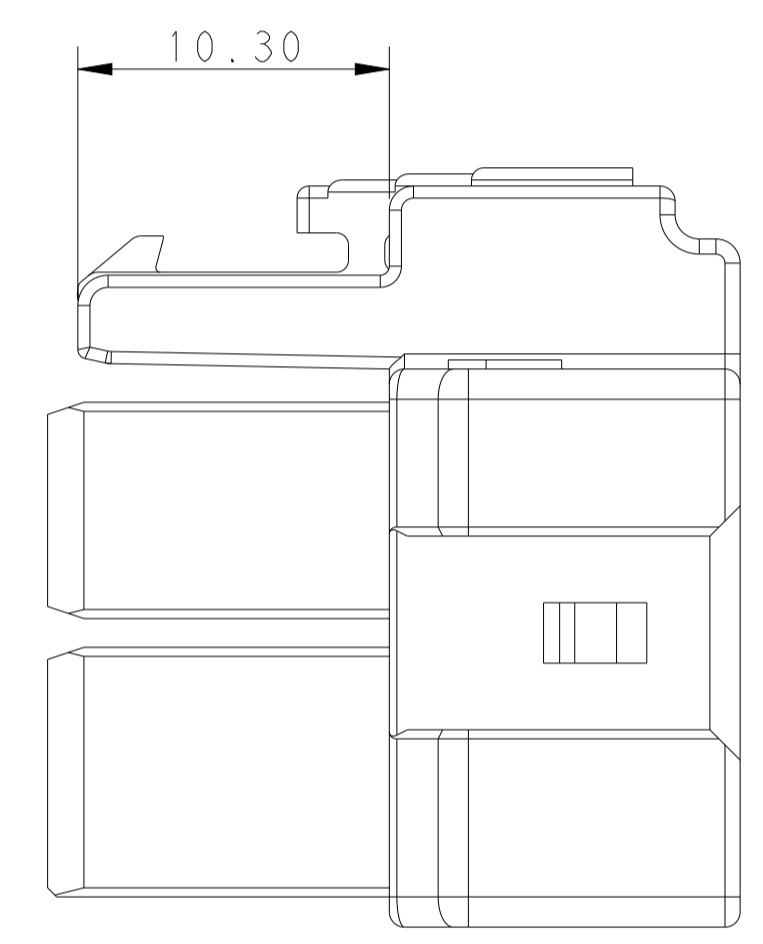
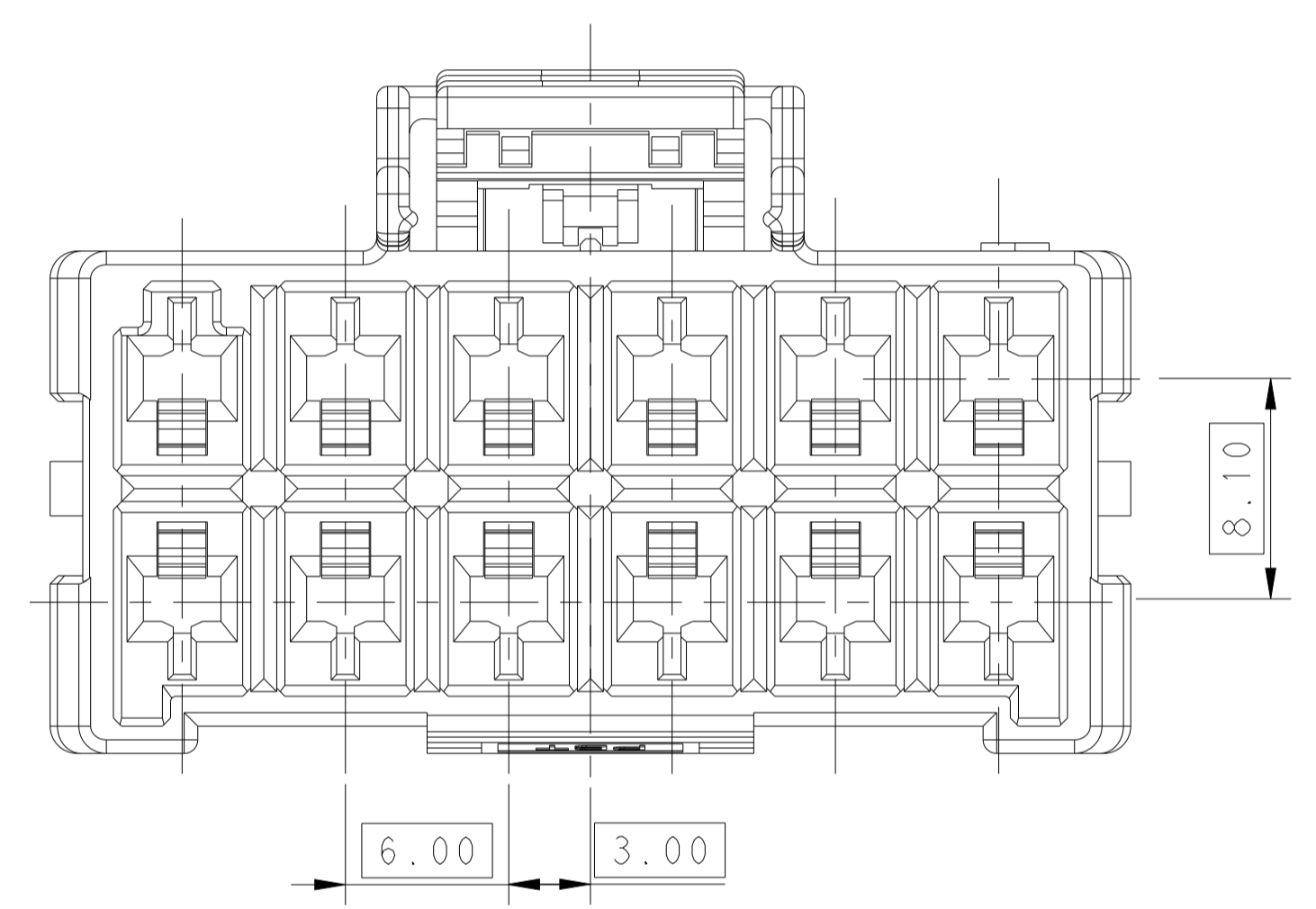

1 MATERIAL:
 LEVEL 1: PBT, STANDARD TEMPERATURE 105°C
 KEY A: NATURAL; KEY B: PURPLE; KEY C: BLUE; KEY D: YELLOW
 LEVEL 2: PA66, HIGH TEMPERATURE 150°C
 KEY A: LIGHT GREY; KEY B: RED; KEY C: BLACK; KEY D: NATURAL

2 MATERIAL MARK:
 LEVEL 1: PBT, LEVEL 2: HDT
 3. APPLICABLE CONTACT P/N
 RECEPTACLE CONTACT: 1971237/1971779/81/83/85/87-*, 2238066-*

4. MATING CONN, P/N
 CAP HSG: *-1971774/5-
 TPA (LOCKING PLATE): *-1971778-*

5 GLOW WIRE COMPLIANT IN ACCORDANCE WITH IEC 60335-1. THIS IS BASED ON THE PRODUCT MEETING A GWEPT 850° C TEST AND RESIN GWIT GREATER THAN OR EQUAL TO 775° C.

THIS DRAWING IS A CONTROLLED DOCUMENT.		DWN: TOMMY WU 09JUL2012	TE Connectivity PLUG HOUSING, DOUBLE ROW POWER TRIPLE LOCK
DIMENSIONS: mm		CHK: HAPYE WU 09JUL2012	
TOLERANCES UNLESS OTHERWISE SPECIFIED:		APVD: YUHONG MAO 09JUL2012	
0 PLC ± 1 PLC ±0.35 2 PLC ±0.25 3 PLC ± 4 PLC ± ANGLES ± FINISH -		PRODUCT SPEC: 108-106118 APPLICATION SPEC: 114-106118 WEIGHT: - Customer Drawing	
MATERIAL: 1		SIZE: A1 CAGE CODE: 00779 DRAWING NO: C=1971776 SCALE: 4:1 SHEET: 1 OF 2 REV: F	RESTRICTED TO: -

LOC		DIST		REVISIONS			
P	LTN	DESCRIPTION	DATE	OWN	APVD		
-	-	SEE SHEET 1	-	-	-		

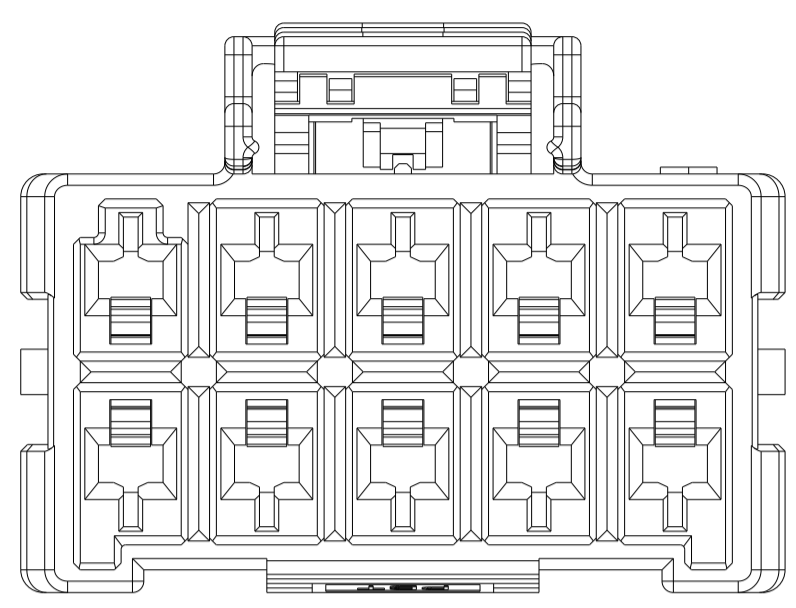
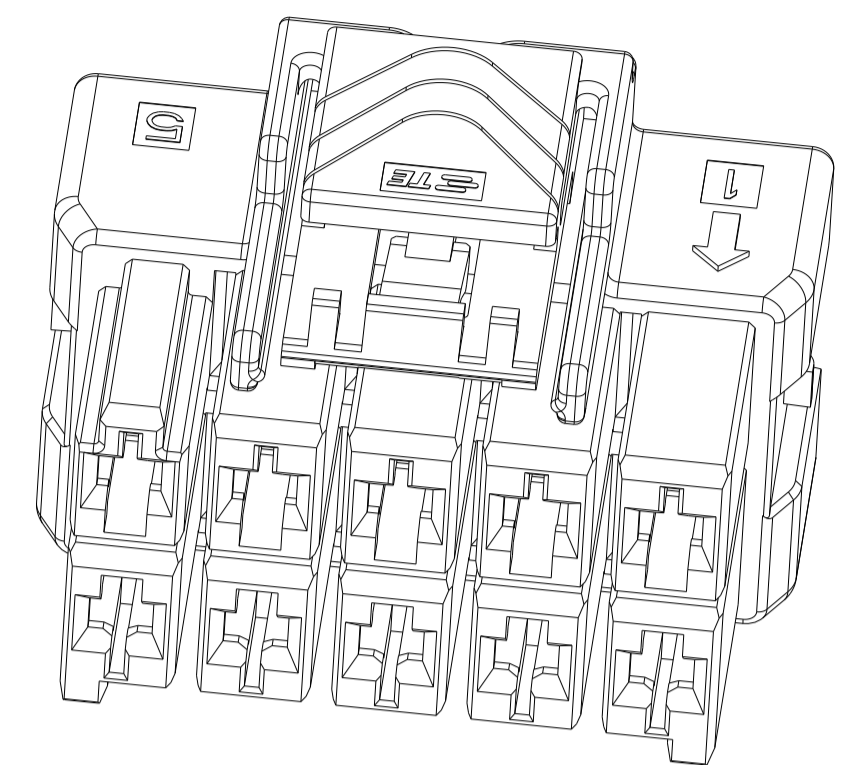

2*5 POSITIONS

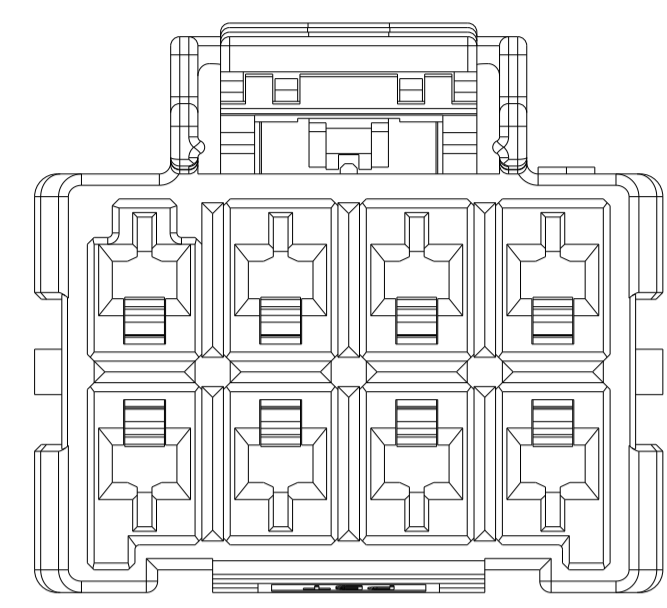
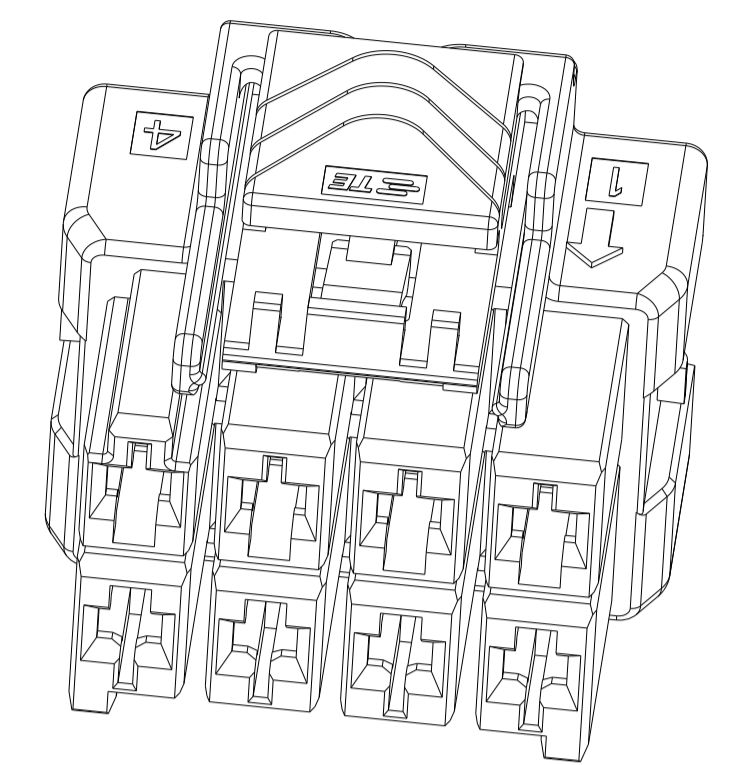

2*4 POSITIONS

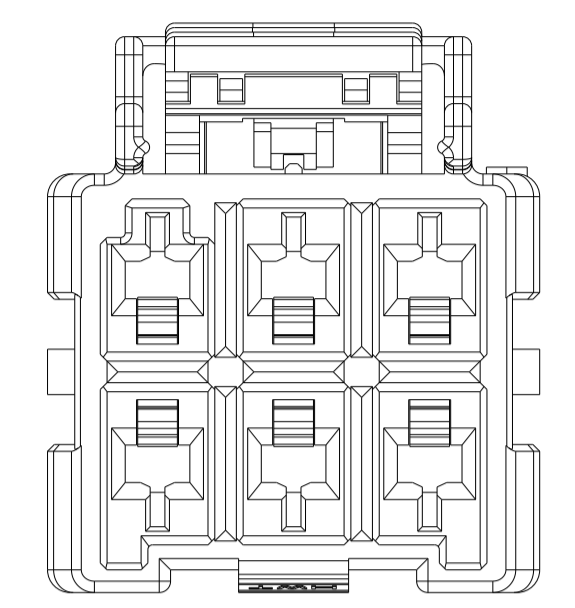
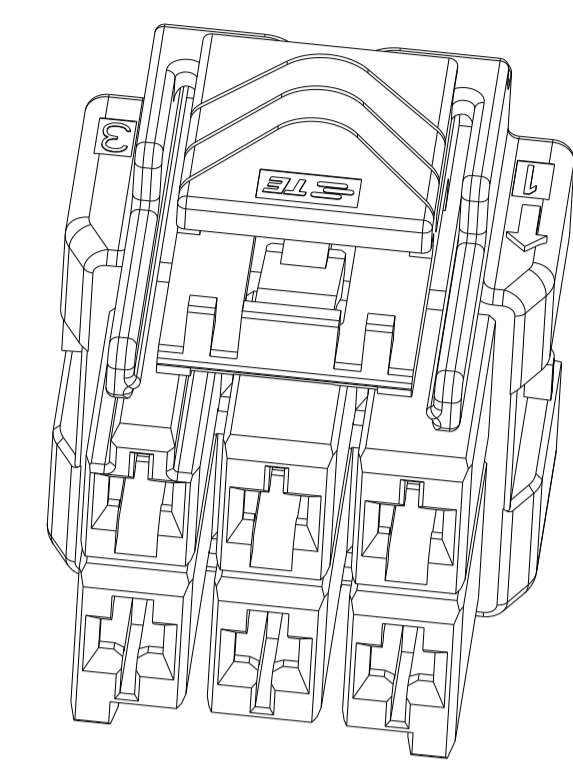

2*3 POSITIONS

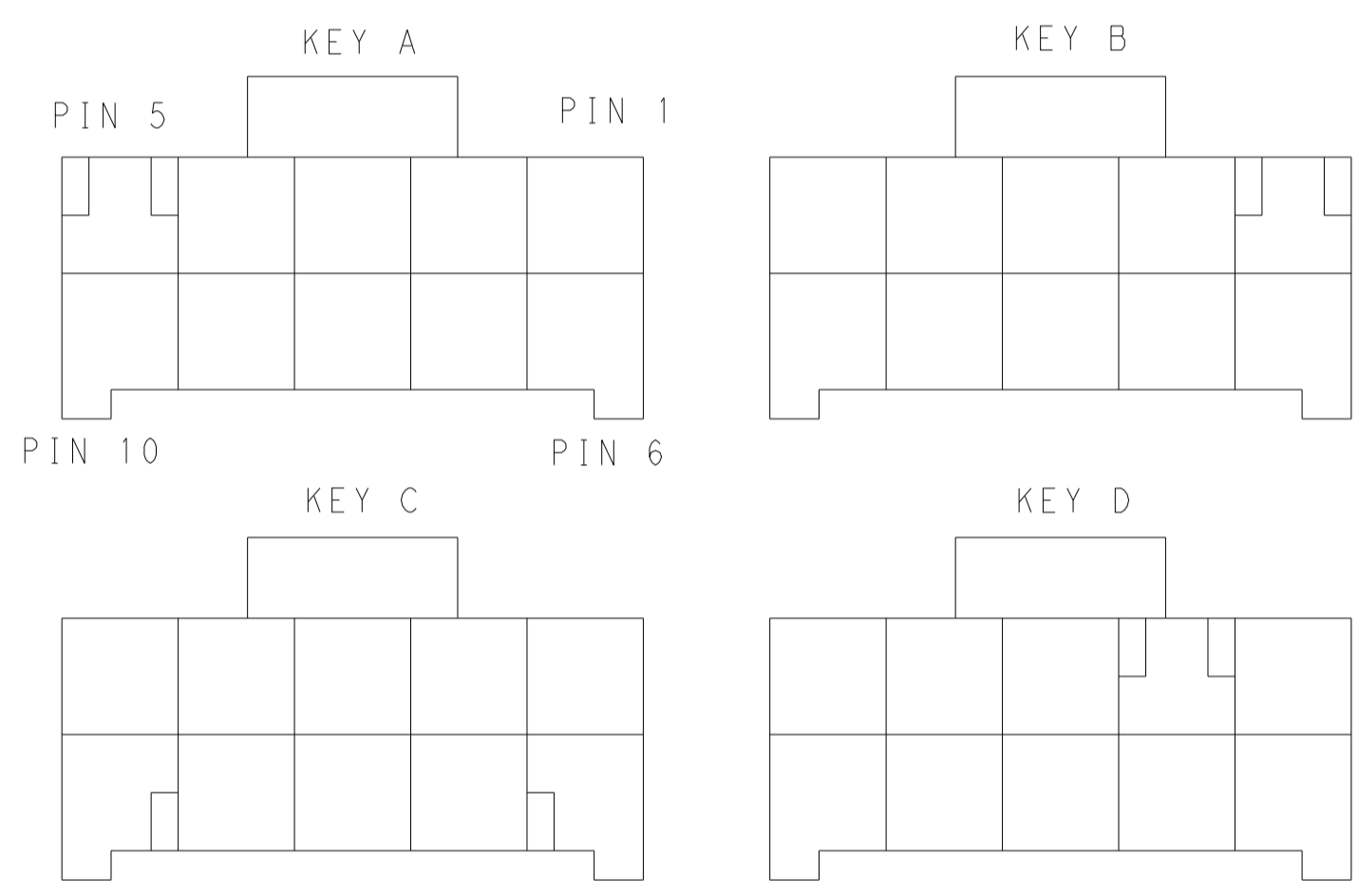

KEYING FOR 2*5 POS.

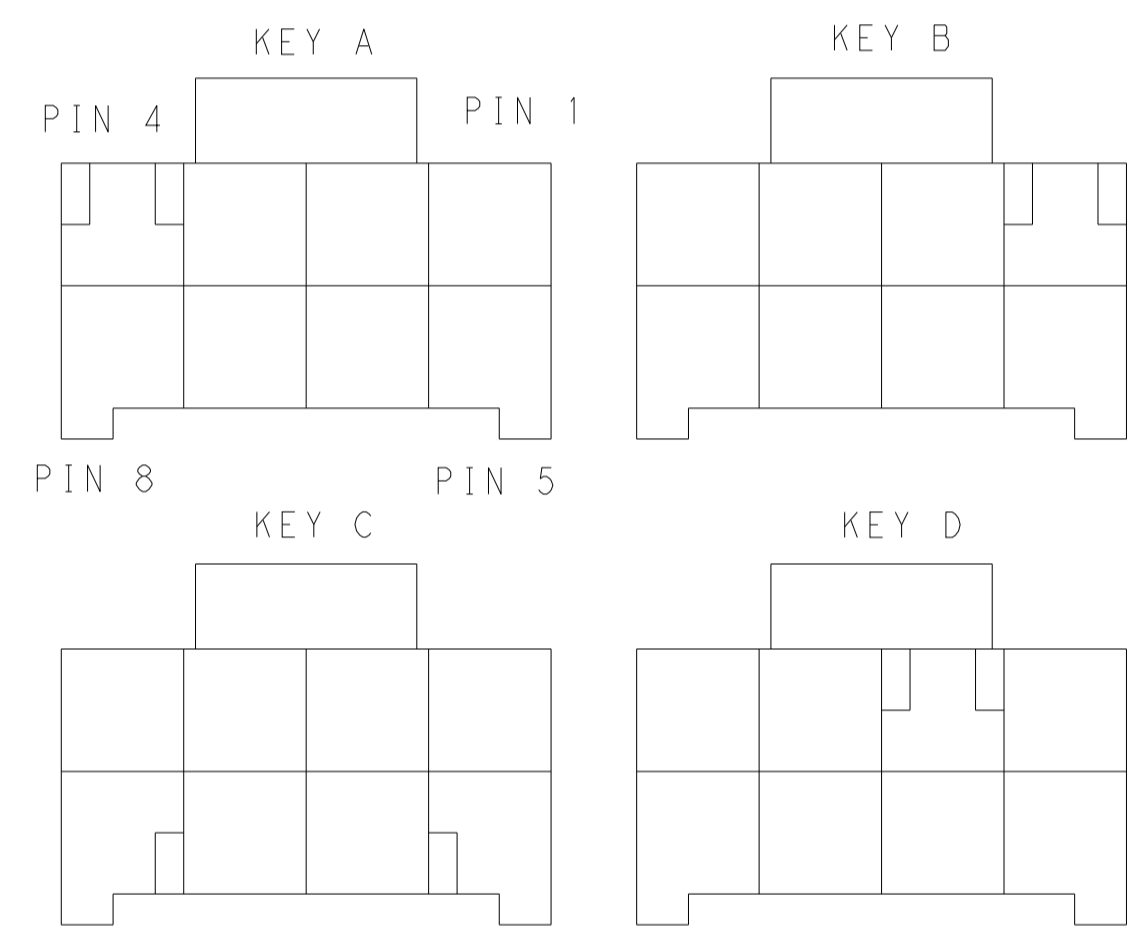

KEYING FOR 2*4 POS.

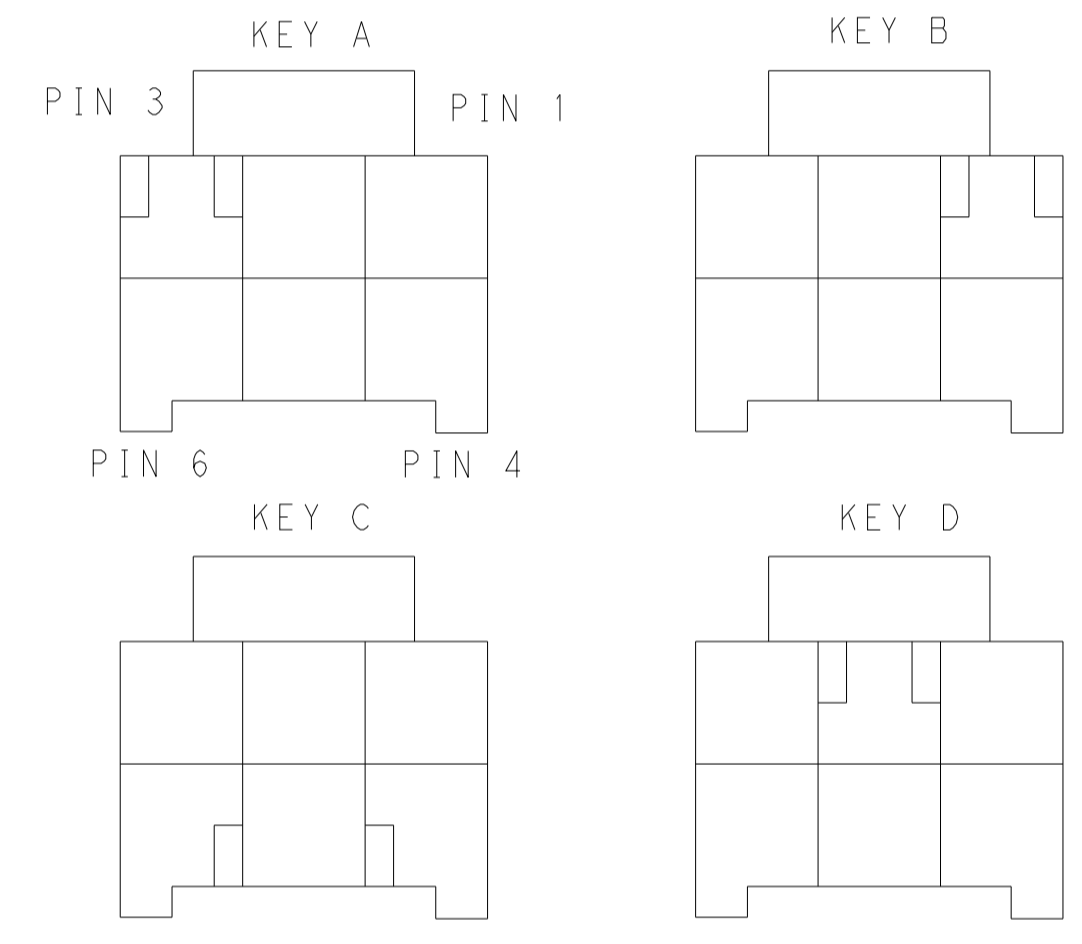

KEYING FOR 2*3 POS.

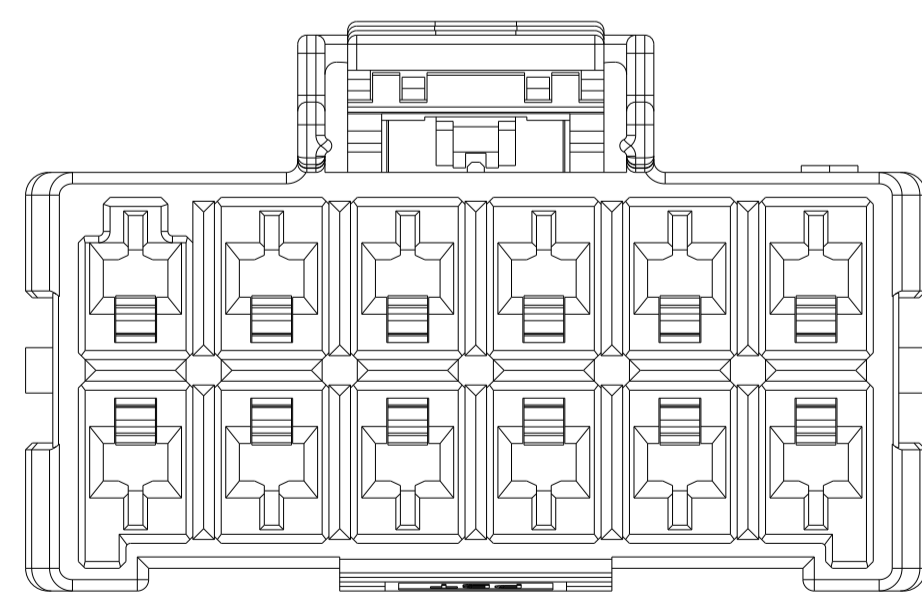
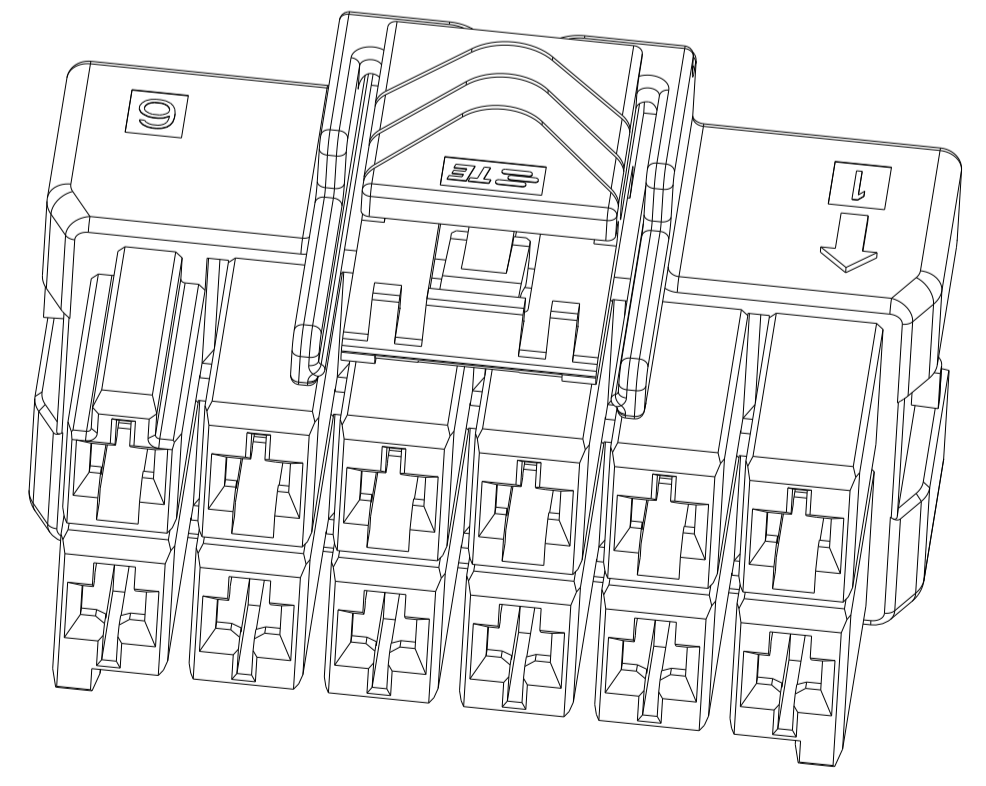

2*6 POSITIONS

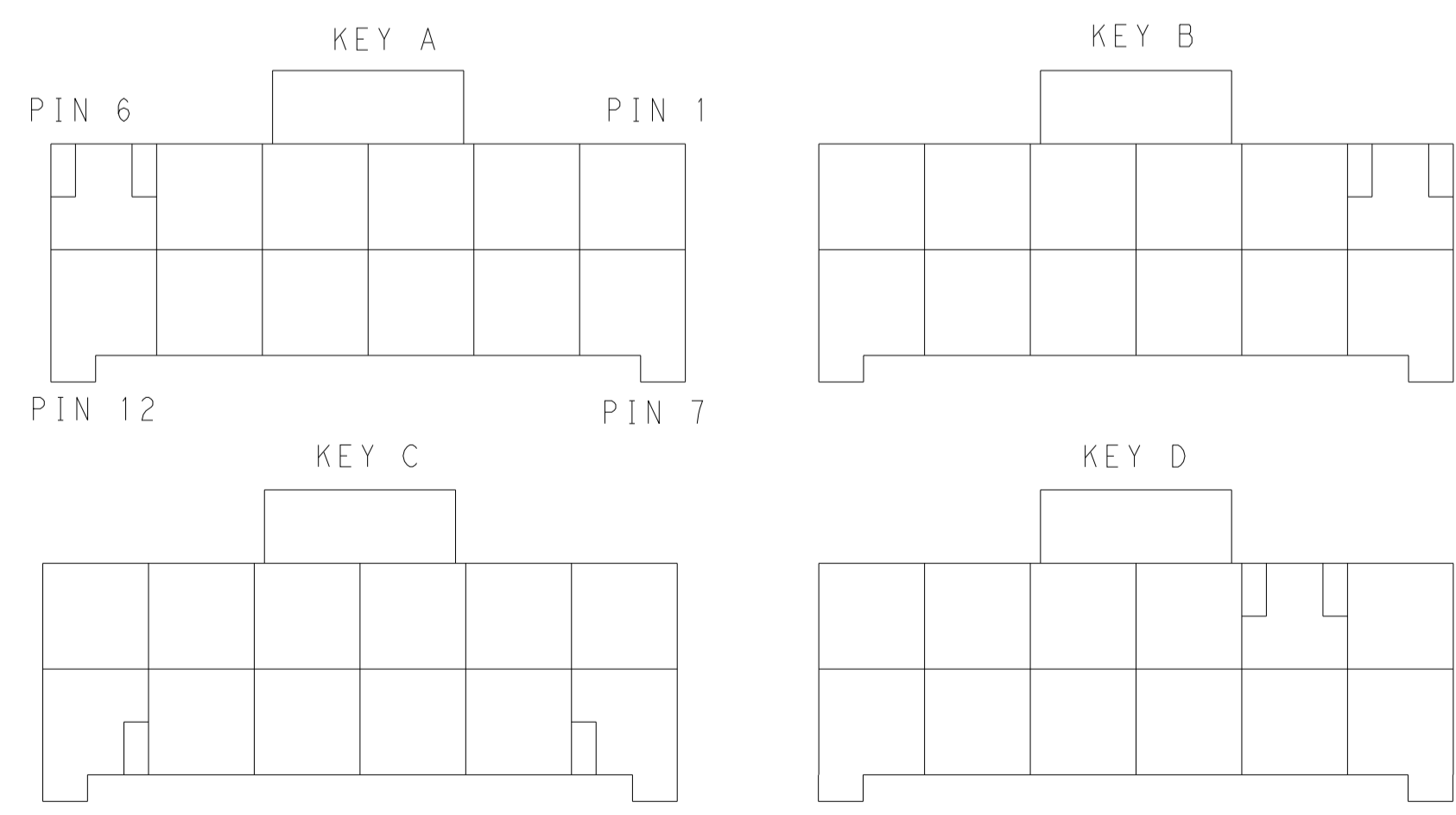

KEYING FOR 2*6 POS.

POS.	MATERIAL	KEY	P/N
2*6	LEVEL 1	KEY A	1-1971776-6
		KEY B	2-1971776-6
		KEY C	3-1971776-6
		KEY D	4-1971776-6
2*6	LEVEL 2	KEY A	5-1971776-6
		KEY B	6-1971776-6
		KEY C	7-1971776-6
		KEY D	8-1971776-6
2*5	LEVEL 1	KEY A	1-1971776-5
		KEY B	2-1971776-5
		KEY C	3-1971776-5
		KEY D	4-1971776-5
2*5	LEVEL 2	KEY A	5-1971776-5
		KEY B	6-1971776-5
		KEY C	7-1971776-5
		KEY D	8-1971776-5

POS.	MATERIAL	KEY	P/N
2*4	LEVEL 1	KEY A	1-1971776-4
		KEY B	2-1971776-4
		KEY C	3-1971776-4
		KEY D	4-1971776-4
2*4	LEVEL 2	KEY A	5-1971776-4
		KEY B	6-1971776-4
		KEY C	7-1971776-4
		KEY D	8-1971776-4
2*3	LEVEL 1	KEY A	1-1971776-3
		KEY B	2-1971776-3
		KEY C	3-1971776-3
		KEY D	4-1971776-3
2*3	LEVEL 2	KEY A	5-1971776-3
		KEY B	6-1971776-3
		KEY C	7-1971776-3
		KEY D	8-1971776-3

THIS DRAWING IS A CONTROLLED DOCUMENT. DWN TOMMY WU 09JUL2012
 CHK HAPYE WU 09JUL2012
 APVD YUHONG MAO 09JUL2012

STE TE Connectivity

NAME: PLUG HOUSING, DOUBLE ROW POWER TRIPLE LOCK

PRODUCT SPEC: 108-106118
 APPLICATION SPEC: 114-106118

SIZE: A1 CAGE CODE: 00779 DRAWING NO: 1971776
 SHEET 2 OF 2 REV F

MATERIAL: . FINISH: . WEIGHT: . SCALE: 4:1

Customer Drawing

X-ON Electronics

Largest Supplier of Electrical and Electronic Components

Click to view similar products for [Heavy Duty Power Connectors](#) category:

Click to view products by [TE Connectivity](#) manufacturer:

Other Similar products are found below :

[6646058-2](#) [6646137-1](#) [6646138-1](#) [6646940-1](#) [6651091-1](#) [6651525-1](#) [6651529-1](#) [696475-1](#) [702-32-01109](#) [73080255059](#) [73080965046](#)
[7310205040001](#) [765-16-0080B](#) [765-18-0080D](#) [902-77-02113](#) [PS00/A0620/6300](#) [AN0024023](#) [154-42B7WM250](#) [MS3117-14AC](#) [1643543-1](#)
[1766966-1](#) [1791340000](#) [NLDFT-3-BL-L-S120-M40A](#) [NLDFT-N-W-L-C240-M40B](#) [1926015-1](#) [NLS-3-BL-C240-M40B](#) [NLS-N-W-C240-](#)
[M40B](#) [NPS-3-BL-T6](#) [2-1589900-8](#) [9300480317](#) [294-0091-01100](#) [296-0040-01100](#) [1-6609148-0](#) [A32595-0049](#) [1766249-1](#) [19000005132](#)
[1926016-1](#) [1-966831-8](#) [AN0024202](#) [AN0264023](#) [279-0841-10100A](#) [281-0334-00100A](#) [RMSB4](#) [419-2083-301](#) [LCDX4/0-14B-X](#) [075-8519-](#)
[001](#) [078238-1613](#) [07.470.3256.0](#) [09000005288](#) [09140240311](#)