

## Type CRGP Series

### Key Features

### Key Features

Small size and light weight

Suitable for both wave and reflow soldering techniques

Supplied on tape

Pulse Rated

7 different package sizes

Terminal finish matte Sn over Ni

AEC-Q200 Compliant



TE Connectivity is pleased to introduce this SMD Pulse withstand thick film Chip resistor, suitable for auto placement in volume and for most applications.

Available in five different packages and supplied on tape and reel for automatic insertion processes. Standard values – E24 Series and now AEC-Q200 Qualified

### Characteristics – Electrical

Type	CRGP0402	CRGP0603	CRGP0805	CRGP1206
Power Rating @ 70°C	0.125W	0.25W	0.33W	0.5W
Max. Working Voltage	50V	50V	150V	200V
Max. Overload Voltage	100V	100V	300V	400V
Dielectric Withstand	100V	300V	500V	500V
Temperature Range	-55°C ~ +155°C			
Ambient Temperature	70°C			

Type	CRGP1210	CRGP2010	CRGP2512
Power Rating @ 70°C	0.75W	1.25W	2W
Max. Working Voltage	200V	400V	500V
Max. Overload Voltage	500V	800V	1000V
Dielectric Withstand	500V	500V	500V
Temperature Range	-55°C ~ +155°C		
Ambient Temperature	70°C		

## Power derating curve

Power rating based on continuous load operation in ambient temperature of 70°C. For resistors operated in ambient temperatures above 70°C, power rating must be derated in accordance with this curve.

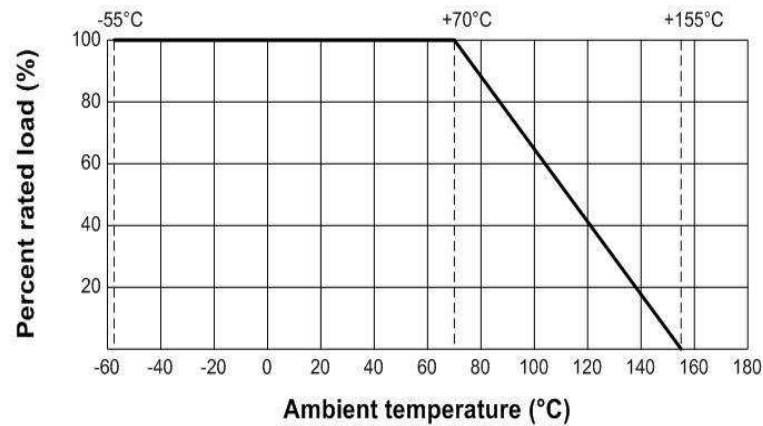

## Dimensions:

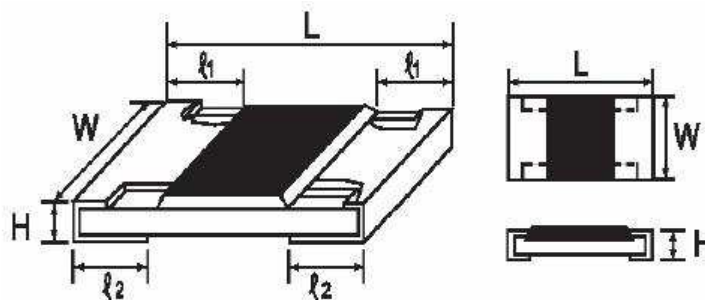

Type	Dimension (mm)				
	L	W	H	ℓ1	ℓ2
CRGP0402	1.10±0.10	0.50±0.05	0.35±0.05	0.20±0.10	0.25±0.10
CRGP0603	1.60±0.10	0.80±0.10	0.45±0.10	0.30±0.20	0.30±0.20
CRGP0805	2.00±0.15	1.25+0.15 -0.10	0.55±0.10	0.40±0.20	0.40±0.20
CRGP1206	3.10±0.15	1.55+0.15 -0.10	0.55±0.10	0.45±0.20	0.45±0.20
CRGP1210	3.10±0.10	2.60±0.20	0.55±0.10	0.55±0.25	0.50±0.20
CRGP2010	5.00±0.10	2.50±0.20	0.55±0.10	0.60±0.25	0.50±0.20
CRGP2512	6.35±0.10	3.20±0.20	0.55±0.10	0.60±0.25	0.50±0.20

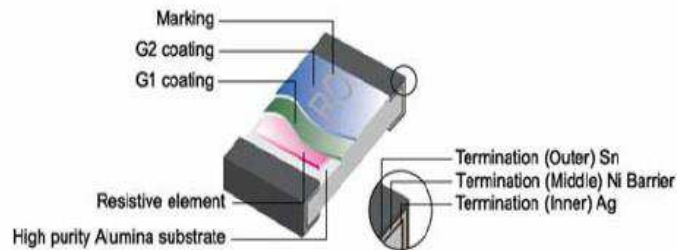
**Construction:****Power Rating and Resistance Range:**

Type	Power Rating @ 70°C	Tolerance	Resistance Range	Standard Series
CRGP0402	0.125W	±1%	1R0 – 10M	E24 E96 by negotiation
		±5%		
CRGP0603	0.25W	±1%	1R0 – 10M	E24 E96 by negotiation
		±5%		
CRGP0805	0.33W	±1%	1R0 – 10M	E24 E96 by negotiation
		±5%		
CRGP1206	0.5W	±1%	1R0 – 10M	E24 E96 by negotiation
		±5%		
CRGP1210	0.75W	±1%	1R0 – 10M	E24 E96 by negotiation
		±5%		
CRGP2010	1.25W	±1%	1R0 – 10M	E24 E96 by negotiation
		±5%		
CRGP2512	2W	±1%	1R0 – 10M	E24 E96 by negotiation
		±5%		

**Marking:**

E24 series 0603 – 2512 3 Digits – first two digits denote significant figures of resistance and third digit denotes number of zeros thereafter. EG

	222	
--	-----	--

=
2K2

Marking for E96 Series 0805 – 2512 4 digits – First three digits denote significant figures of resistance and fourth digit denotes number of zeros thereafter. EG.

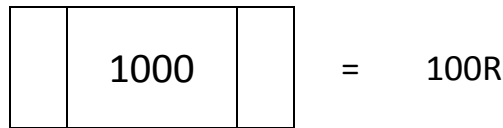

For ohmic values below 100R letter “R” denotes decimal point. EG

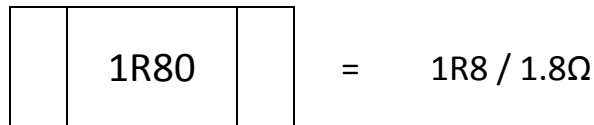

0402 size chips are not marked

0603 E96 3 digit marking.

**Mutiplier Code :**

Code	A	B	C	D	E	F	G	H	X	Y	Z
Multiplier	10 <sup>0</sup>	10 <sup>1</sup>	10 <sup>2</sup>	10 <sup>3</sup>	10 <sup>4</sup>	10 <sup>5</sup>	10 <sup>6</sup>	10 <sup>7</sup>	10 <sup>-1</sup>	10 <sup>-2</sup>	10 <sup>-3</sup>

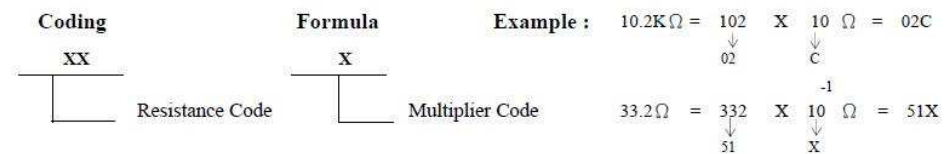

Value	Code	Value	Code	Value	Code	Value	Code	Value	Code
100	01	162	21	261	41	422	61	681	81
102	02	165	22	267	42	432	62	698	82
105	03	169	23	274	43	442	63	715	83
107	04	174	24	280	44	453	64	732	84
110	05	178	25	287	45	464	65	750	85
113	06	182	26	294	46	475	66	768	86
115	07	187	27	301	47	487	67	787	87
118	08	191	28	309	48	499	68	806	88
121	09	196	29	316	49	511	69	825	89
124	10	200	30	324	50	523	70	845	90
127	11	205	31	332	51	536	71	866	91
130	12	210	32	340	52	549	72	887	92
133	13	215	33	348	53	562	73	909	93
137	14	221	34	357	54	576	74	931	94
140	15	226	35	365	55	590	75	953	95
143	16	232	36	374	56	604	76	976	96
147	17	237	37	383	57	619	77		
150	18	243	38	392	58	634	78		
154	19	249	39	402	59	649	79		
158	20	255	40	412	60	665	80		

### Pulse withstand capacity

The single impulse graph is the result of 50 impulses of rectangular shape applied at one-minute intervals. The limit of acceptance was a shift in resistance of less than 1% from the initial value. The power applied was subject to the restrictions of the maximum permissible impulse voltage graph shown.

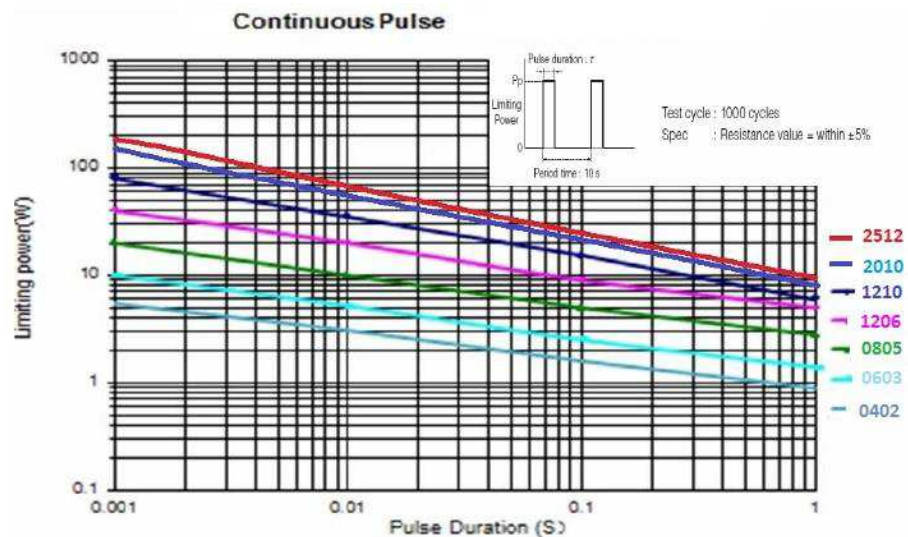
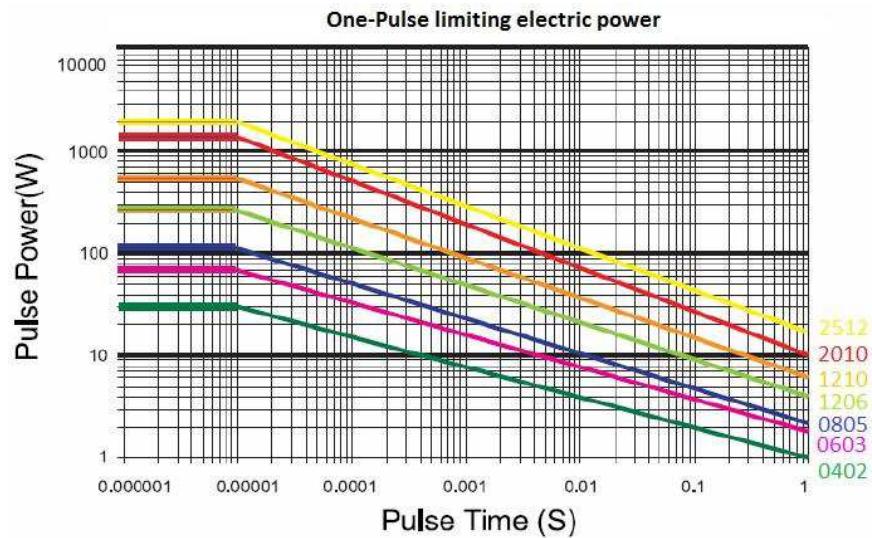

**Performance Specification:**

Characteristic	Limits	Test Methods (AEC-Q200)
Operational life	±5%, ±10%, ±20%: ±(3%+0.1Ω)Max.	125°C, at35% of operating power, 1000H(1.5 hours “ON”, 0.5 hour “OFF”). (MIL-STD-202)
Temperature Coefficient	1Ω~10Ω : ± 400 PPM/°C 10.1Ω~10MΩ : ± 100 PPM/°C	Natural resistance change per temp. degree centigrade R1-R2 ----- x10 <sup>6</sup> (PPM/°C) R1(t2-t1) R1 resistance value at room temperature (t1) R2 Resistance value at room temperature +100°C (t2)
External Visual	No Mechanical Damage	Electrical test not required. Inspect device construction, marking and workmanship (MIL-STD-883 Method 2009)
Physical Dimensions	Reference 2.0 Dimension Standards	Verify physical dimensions to the applicable device detail specification. Note: User(s) and Suppliers spec. Electrical test not required. (JESD22 MH Method JB-100)
Resistance to Solvent	Marking Unsmearred	Note: Add Aqueous wash chemical – OKEM Clean or equivalent. Do not use banned solvents. ( MIL-STD-202 Method 215)
Terminal Strength	Not Broken	Force of 1.8kg for 60 seconds. (JIS-C-6429)
Terminal Bending	± (1.0% ±0.05Ω) Max.	Twist of Test Board : Y/X = 5/90 mm for 10 seconds (Sub-clause 4.33)
High Temperature Exposure (Storage)	±(1%+0.1Ω)max	1000hrs. @T=155°C.Unpowered. Measurement at 24±2 hours after test conclusion. (MIL-STD-202 Method 108)
Temperature Cycling	Resistance change rate is ±5%, ±10%, ±20%: ± (1.0%+0.1Ω) Max.	1000 Cycles (-55°C to +155°C). Measurement at 24±2 hours after test conclusion. (JESD22 Method JA-104)
Solderability	95% coverage Min.	Test temperature of solder : 245 ± 3 °C Dwell time in solder : 2 ~ 3 seconds (Sub-clause 4.17) For both leaded & SMD. Electrical test not required. 95% coverage Min. Magnification 50X. Conditions: ( J-STD-002)
Soldering Heat	Resistance change rate is ±(1.0%+0.05Ω) Max.	Dip the resistor into a solder bath having a temperature of 260°C±3°C and hold it for 10±1 seconds (Sub-clause 4.18)
Insulation Resistance	1,000MΩ or more	Apply 500V DC between protective coating and termination for 1 min, then measure (Sub-clause 5.6)

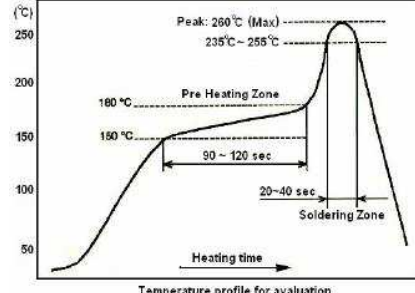
Characteristic	Limits	Test Methods (AEC-Q200)
Solder Temp. Reference	Electrical characteristics shall be satisfied without distinct deformation in appearance. (95% coverage Min.)	Wave soldering condition: (2 cycles Max.) Pre-heat : 100 ~ 120 °C, 30 ± 5 sec. Suggestion solder temp.: 235 ~ 255 °C, 10 seconds max. Peak temp.: 260 °C Reflow soldering condition: (2 cycles Max.) Pre-heat : 150 ~ 180 °C, 90 ~ 120 sec. Suggestion solder temp.: 235 ~ 255 °C, 20 ~ 40 sec. Peak temp.: 260 °C  Hand Soldering 300°C 5 seconds
Short term overload	Resistance change rate is ±5% : ±(2.0% ±0.1Ω) Max. ±1% : ±(1.0% ±0.1Ω) Max.	Permanent resistance change after the application of a potential of 2.5 times RCWV for 5 seconds Sub-clause 4.13
Dielectric Withstand Voltage	No evidence of flashover, mechanical damage, arcing or insulation breakdown.	Apply 500V AC between protective coating and termination for 1 minute (Sub-clause 4.7)
Humidity	Resistance change rate is: ± (3.0% + 0.1Ω) Max.	Temporary resistance change after 240 hours exposure in a humidity test chamber controlled at 40±2°C and 90-95% relative humidity (Sub-clause 4.24)
Load Life In Humidity	Resistance change rate is: ±5% : ±(3.0% ±0.1Ω) Max. ±1% : ±(1.0% ±0.1Ω) Max.	Resistance change after 1,000 hours (1.5 hours "on", 0.5 hour "off") at RCWV in a humidity chamber controlled at 40°C ± 2°C and 90 to 95 % relative humidity. (Sub-clause 4.24.2.1)
Load Life	Resistance change rate is: ±5% : ±(3.0% ±0.1Ω) Max. ±1% : ±(1.0% ±0.1Ω) Max.	Permanent resistance change after 1,000 hours operating at RCWV, with duty cycle of (1.5 hours "on", 0.5 hour "off") at 70°C ± 2°C ambient (Sub-clause 4.25.1)

### Packaging Specification

#### Paper Taping

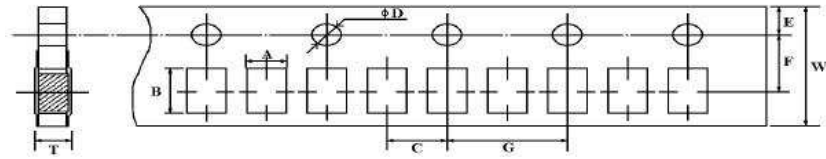

Type	A ±	B ±	C ±	ØD +0.1 -0	E ±	F ±	G ±	W ±	T ±
0402	0.65	1.15	2.0	1.5	1.75	3.5	4.0	8.0	0.45
0603	1.10	1.90	2.0	1.5	1.75	3.5	4.0	8.0	0.67
0805	1.65	2.40	2.0	1.5	1.75	3.5	4.0	8.0	0.81
1206	2.00	3.60	2.0	1.5	1.75	3.5	4.0	8.0	0.81
1210	2.80	3.50	2.0	1.5	1.75	3.5	4.0	8.0	0.75

#### Embossed Taping

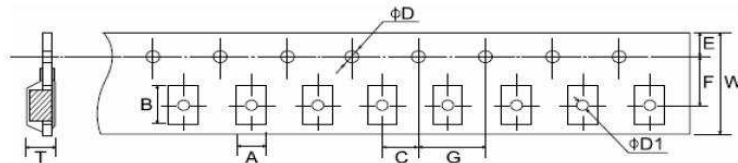

Type	A ±	B ±	C ±	ØD +0.1 -0	ØD1 +0.1 -0	E ±	F ±	G ±	W ±	T ±
2010	2.90	5.60	2.0	1.5	1.5	1.75	5.5	4.0	12.0	1.0
2512	3.50	6.70	2.0	1.5	1.5	1.75	5.5	4.0	12.0	1.0

Peeling strength of cover tape:

Test condition: 0.1 to 0.7 N at a peel off speed of 300mm / min.

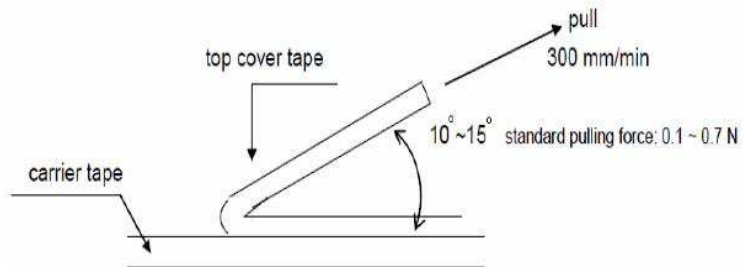



## Reel Dimensions (mm):

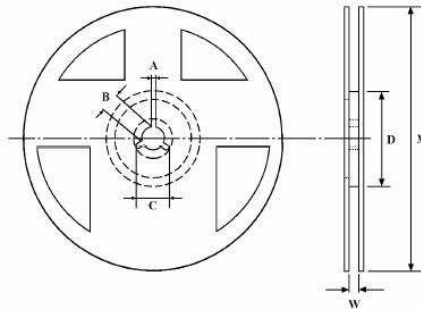

Type	Tape	Reel Qty	A ± 0.5	B ± 0.5	C ± 0.5	D ± 1	M ± 2	W ± 1
0402	Paper	10,000	2	13	21	60	178	10
0603	Paper	5,000	2	13	21	60	178	10
0805	Paper	5,000	2	13	21	60	178	10
1206	Paper	5,000	2	13	21	60	178	10
1210	Paper	5,000	2	13	21	60	178	10
2010	Embossed	4,000	2	13	21	60	178	13.8
2512	Embossed	4,000	2	13	21	60	178	13.8

**Environment Related Substance**

This product complies to EU RoHS directive, EU PAHs directive, EU PFOS directive and Halogen free.

**Ozone layer depleting substances.**

Ozone depleting substances are not used in our manufacturing process of this product.

This product is not manufactured using Chloro fluorocarbons (CFCs), Hydrochlorofluorocarbons (HCFCs), Hydrobromofluorocarbons (HBFCs) or other ozone depleting substances in any phase of the manufacturing process.

**Storage Condition**

The performance of these products, including the solderability, is guaranteed for a year from the date of arrival at your company, provided that they remain packed as they were when delivered and stored at a temperature of  $25^{\circ}\text{C} \pm 10^{\circ}\text{C}$  and a relative humidity of  $60\%RH \pm 10\%RH$ , chemical and dust free atmosphere

Even within the above guarantee periods, do not store these products in the following conditions otherwise, their electrical performance and/or solderability may be deteriorated, and the packaging materials (e.g. taping materials) may be deformed or deteriorated, resulting in mounting failures.

1. In salty air or in air with a high concentration of corrosive gas, such as  $\text{Cl}_2$ ,  $\text{H}_2\text{S}$ ,  $\text{NH}_3$ ,  $\text{SO}_2$ , or  $\text{NO}_2$
2. In direct sunlight

**Solder Profile**

Wave soldering condition: (2 cycles Max.)

Pre-heat : 100 ~ 120 °C, 30 ± 5 sec.

Suggestion solder temp.: 235 ~ 255 °C, 10 seconds

Peak temp.: 260 °C

Reflow soldering condition: (2 cycles Max.)

Pre-heat : 150 ~ 180 °C, 90 ~ 120 sec.

Suggestion solder temp.: 235 ~ 255 °C, 20 ~ 40 seconds

Peak temp.: 260 °C

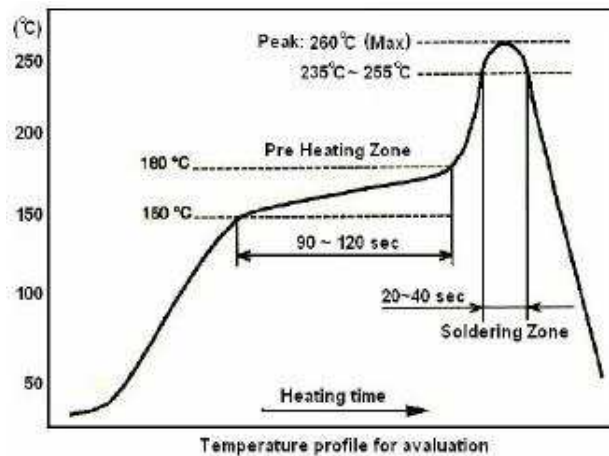

Hand Soldering condition: The Soldering iron tip should be less than 300°C and maximum contact time should be 5 seconds

**How To Order**

CRGP	0603	J	10K
Common Part	Size	Tolerance	Resistance Value
CRGP – Pulse Withstand Thick Film Chip Resistor	0402	F - ±1% J - ±5%	1 ohm (1Ω) 1R0
	0603		1K ohm (1000Ω) 1K0
	0805		100K ohm (100000Ω) 100K
	1206		
	1210		
	2010		
	2512		1M ohm (1000000Ω) 1M0

## X-ON Electronics

Largest Supplier of Electrical and Electronic Components

*Click to view similar products for* [Thick Film Resistors - SMD category:](#)

*Click to view products by* [TE Connectivity manufacturer:](#)

Other Similar products are found below :

[CR-05FL7--19K6](#) [CR-05FL7--243R](#) [CR-05FL7--40K2](#) [CR-12JP4--680R](#) [M55342K03B499DRS6](#) [M55342K06B10D0RS6](#)  
[M55342K06B14E0RS6](#) [M55342K06B16E2RS2](#) [M55342K06B24E9RS6](#) [M55342K06B309DRS3](#) [M55342K06B6E81RS3](#)  
[M55342K08B100DRWB](#) [M55342M06B26E7RS3](#) [MC0603-511-JTW](#) [742C083750JTR](#) [MCR01MZPF1202](#) [MCR01MZPF1601](#)  
[MCR01MZPF1800](#) [MCR01MZPF4992](#) [MCR01MZPF6201](#) [MCR01MZPF9102](#) [MCR01MZPJ113](#) [MCR01MZPJ121](#) [MCR01MZPJ125](#)  
[MCR01MZPJ203](#) [MCR01MZPJ751](#) [MCR01MZPJ822](#) [MCR03EZHJ103](#) [MCR03EZPFX1272](#) [MCR03EZPFX2004](#) [MCR03EZPJ123](#)  
[MCR03EZPJ270](#) [MCR03EZPJ821](#) [MCR10EZPF1102](#) [MCR10EZPF2003](#) [MCR10EZPF2700](#) [MCR18EZPJ101](#) [MCR18EZPJ330](#)  
[RC0603F1473CS](#) [RC0603F150CS](#) [RC1005F1152CS](#) [RC1005F1182CS](#) [RC1005F1372CS](#) [RC1005F183CS](#) [RC1005F1911CS](#)  
[RC1005F1912CS](#) [RC1005F201CS](#) [RC1005F203CS](#) [RC1005F2052CS](#) [RC1005F241CS](#)