

THIS DRAWING IS UNPUBLISHED. RELEASED FOR PUBLICATION
 © COPYRIGHT 19 BY TYCO ELECTRONICS CORPORATION. ALL RIGHTS RESERVED.

LOC	DIST	REVISIONS					
		P	LTR	DESCRIPTION	DATE	DWN	APVD
FX	00		A	RELEASED PER NPR 2001054	19APR2001	DWF	DWF

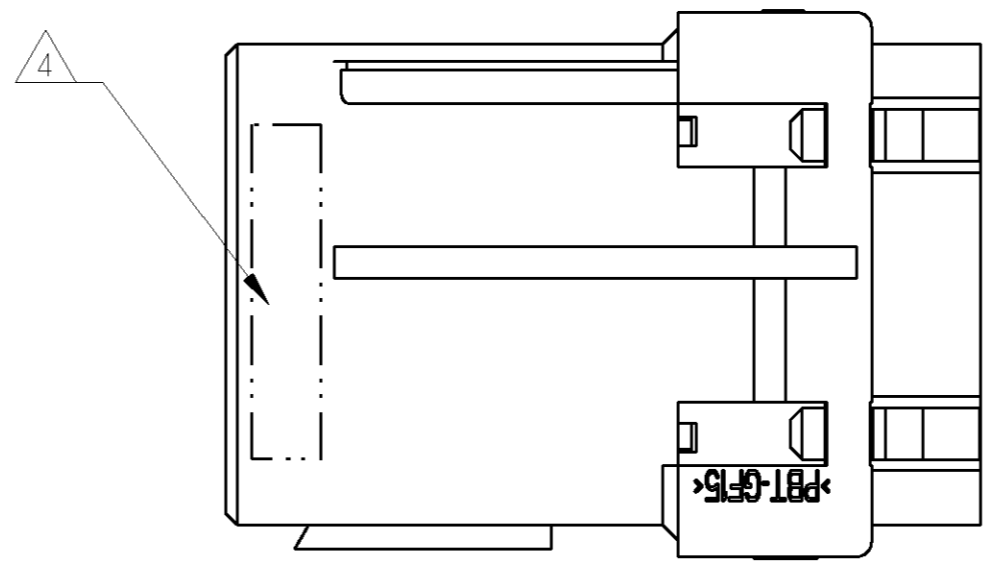
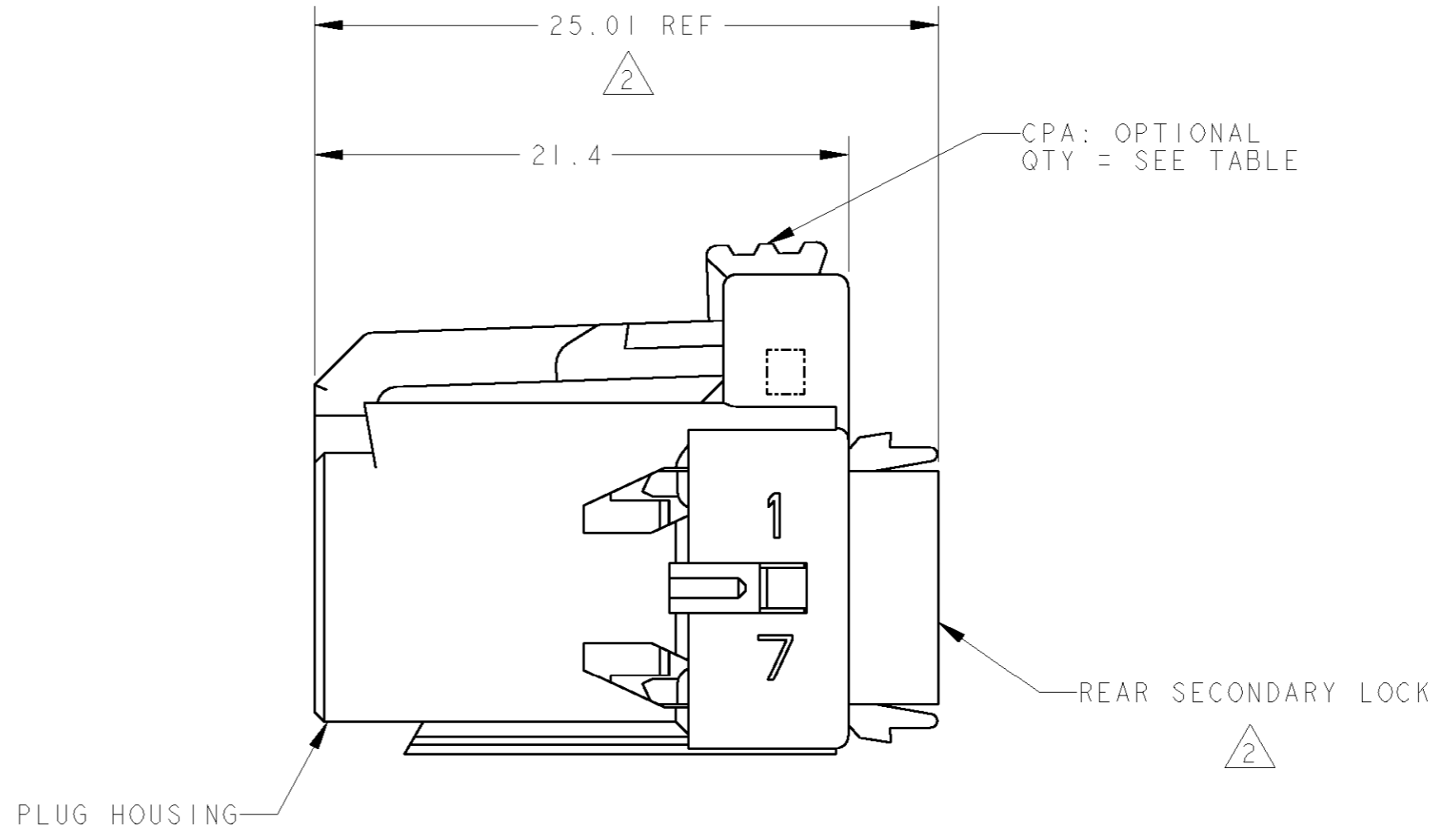
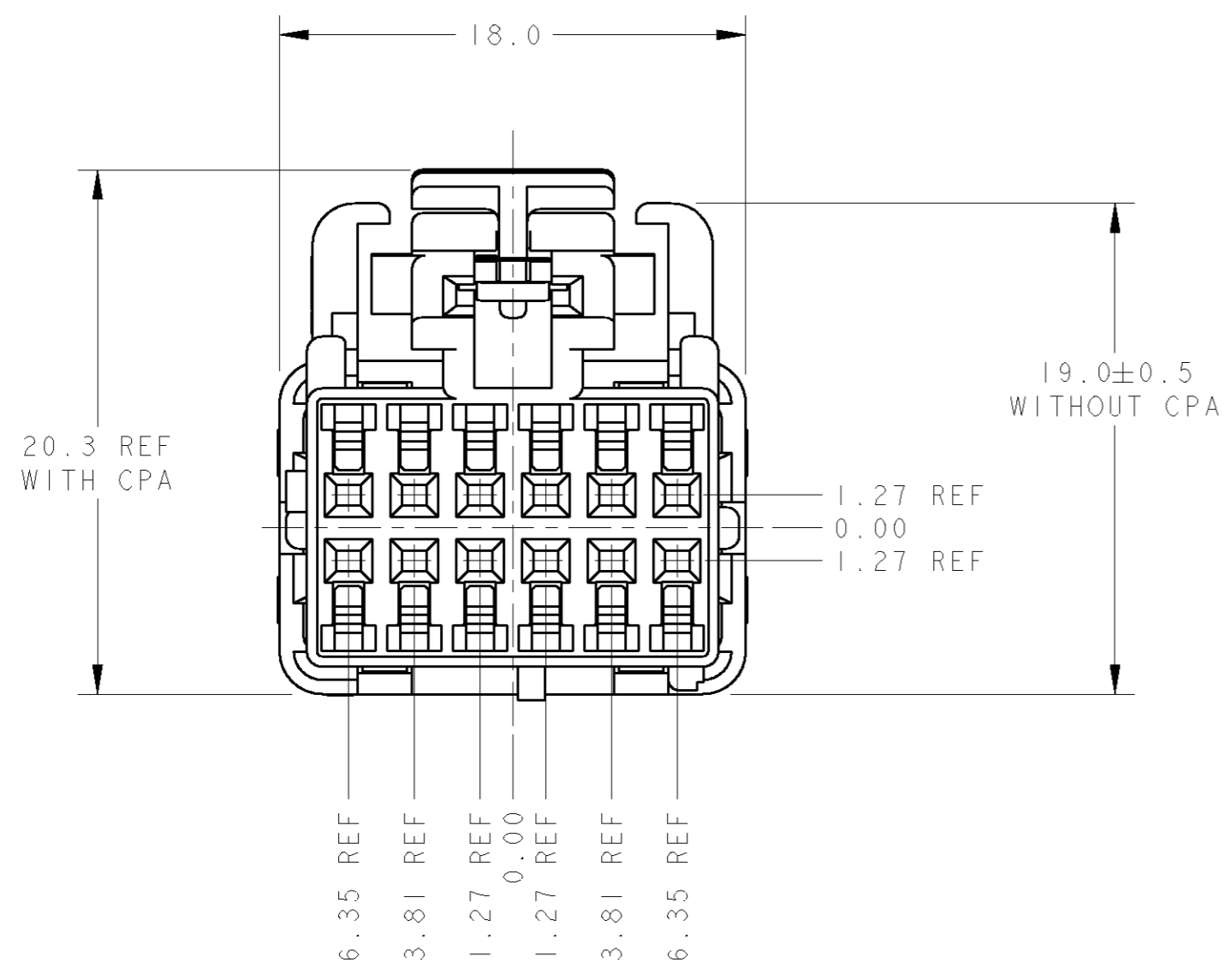

- 638394-5 SHOWN.
- REAR SECONDARY LOCK, SHOWN IN PRE-LATCHED POSITION.
- PLUG HOUSING: PBT, 15% GLASS FILLED, 25% MAX REGRIND, COLOR: SEE TABLE. REAR SECONDARY LOCK: PBT, UNFILLED, GRAY, 25% MAX REGRIND. CPA: PBT, 15% GLASS FILLED, RED, 25% MAX REGRIND.
- MARK FOUR DIGIT JULIAN DATE CODE (DDDY), LOCATED IN APPROXIMATE AREA SHOWN.
- TERMINALS SOLD SEPARATELY, SEE AMP RECOMMENDED P/N 1326028 (GOLD) OR 638551 (TIN) FOR TERMINATION AND REELING OPTIONS.
- THIS PRODUCT HAS A MISMATING FORCE OF 100 NEWTONS.
- WEIGHT OF ASSEMBLY WITH CPA IS: 3.6 GRAMS
WEIGHT OF ASSEMBLY WITHOUT CPA IS: 3.5 GRAMS

COLOR	CPA QTY	KEYING ARRANGEMENT (SEE SHEET 2)	PART NUMBER
GREEN	1	"D"	638394-8
BLUE	1	"C"	638394-7
YELLOW	1	"B"	638394-6
BLACK	1	"A"	638394-5
GREEN	N/A	"D"	638394-4
BLUE	N/A	"C"	638394-3
YELLOW	N/A	"B"	638394-2
BLACK	N/A	"A"	638394-1

THIS DRAWING IS A CONTROLLED DOCUMENT FOR TYCO ELECTRONICS CORPORATION IT IS SUBJECT TO CHANGE AND THE CONTROLLING ENGINEERING ORGANIZATION SHOULD BE CONTACTED FOR THE LATEST REVISION.		DWN D. FRY 26AUG99	AMP Incorporated Harrisburg, PA 17105-3608	
DIMENSIONS: mm		CHK A. EBRAHEEM 19APR2001	NAME PLUG ASSEMBLY, UNSEALED, 12 POSITION 2X6, 0.64mm CONNECTOR	
TOLERANCES UNLESS OTHERWISE SPECIFIED: 0 PLC ± 1 PLC ±0.4 2 PLC ±0.30 3 PLC ± 4 PLC ± ANGLES ± FINISH -		APVD G. BALON 19APR2001	RESTRICTED TO	
MATERIAL		PRODUCT SPEC SAE/USCAR-2 8/97	SIZE A2	CAGE CODE 00779
3		APPLICATION SPEC	DRAWING NO 638394	REV A
CUSTOMER DRAWING		WEIGHT	SCALE 4:1	SHEET 1 OF 2

THIS DRAWING IS UNPUBLISHED. RELEASED FOR PUBLICATION
 © COPYRIGHT 19 BY TYCO ELECTRONICS CORPORATION. ALL RIGHTS RESERVED.

LOC	DIST	REVISIONS					
		P	LTR	DESCRIPTION	DATE	DWN	APVD
FX	00	-		SEE SHEET 1	-	-	-

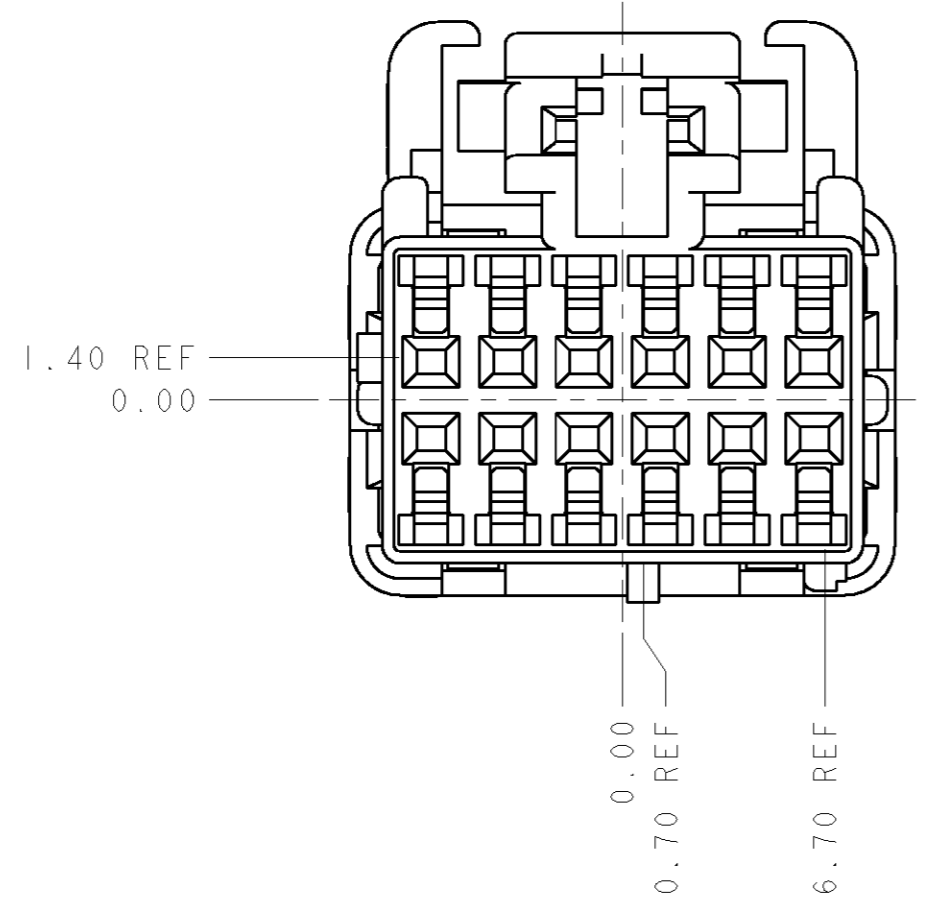

KEY CODE "A"
 (APPLIES TO -1 AND -5 ONLY)
 SCALE 4:1

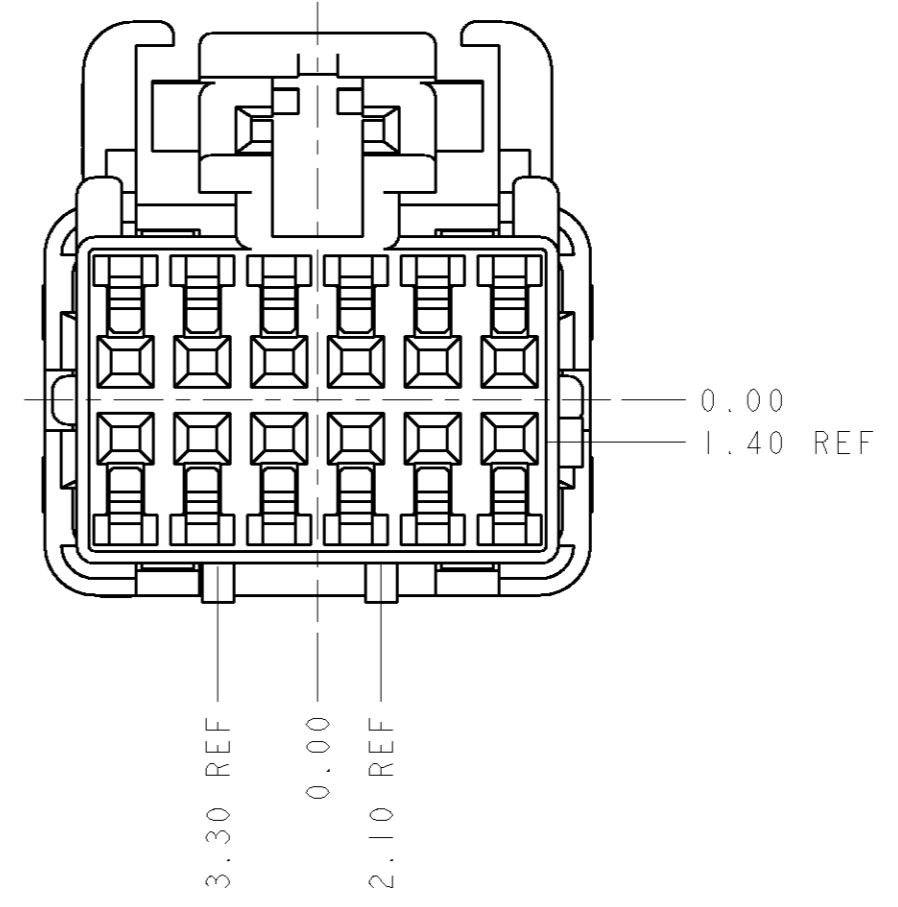

KEY CODE "B"
 (APPLIES TO -2 AND -6 ONLY)
 SCALE 4:1

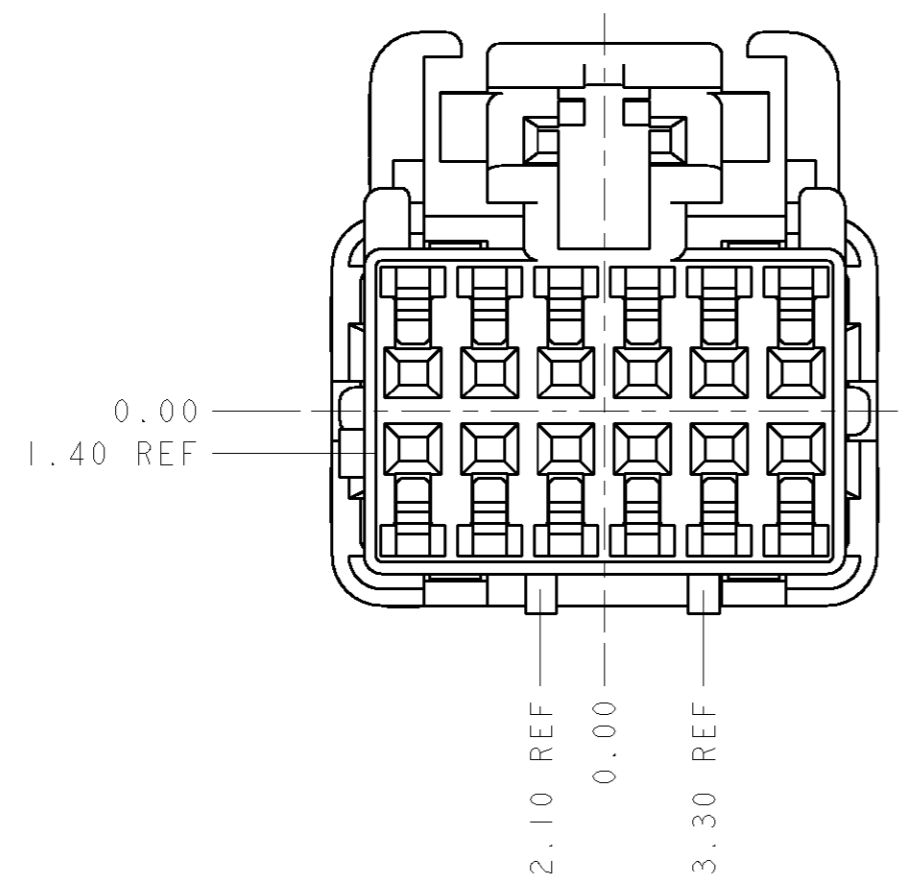

KEY CODE "C"
 (APPLIES TO -3 AND -7 ONLY)
 SCALE 4:1

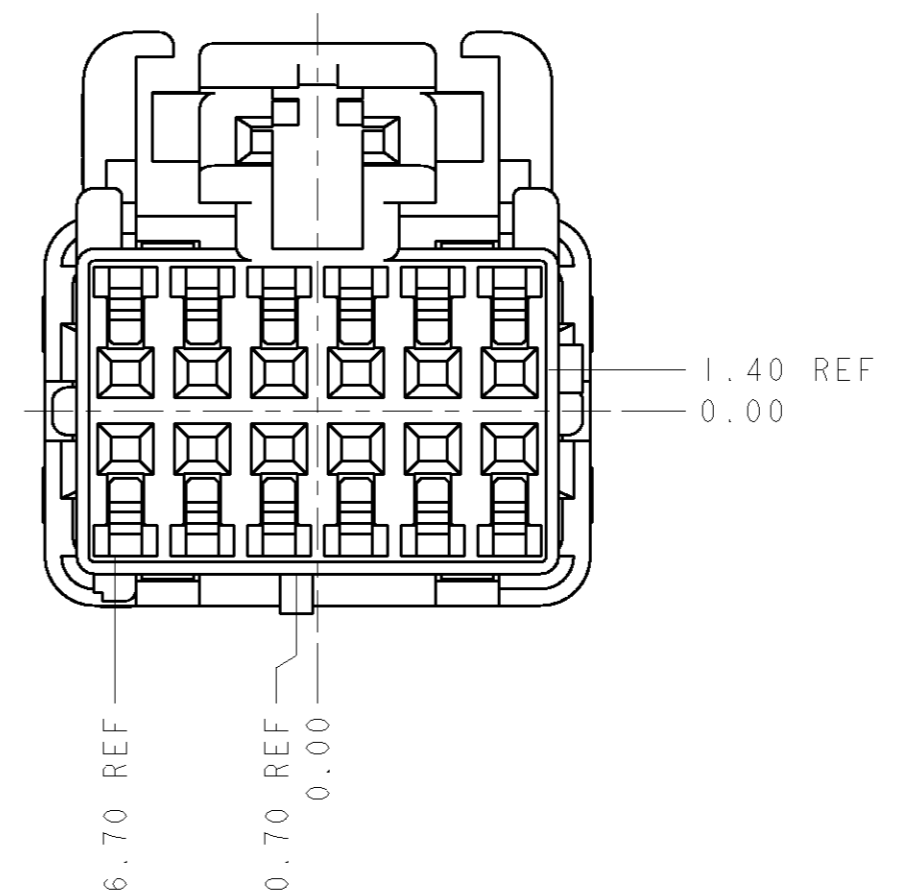

KEY CODE "D"
 (APPLIES TO -4 AND -8 ONLY)
 SCALE 4:1

<small>THIS DRAWING IS A CONTROLLED DOCUMENT FOR TYCO ELECTRONICS CORPORATION IT IS SUBJECT TO CHANGE AND THE CONTROLLING ENGINEERING ORGANIZATION SHOULD BE CONTACTED FOR THE LATEST REVISION.</small>		DWN D. FRY 26AUG99 CHK A. EBRAHEEM 19APR2001 APVD G. BALON 19APR2001	AMP AMP Incorporated Harrisburg, PA 17105-3608
DIMENSIONS: mm 	TOLERANCES UNLESS OTHERWISE SPECIFIED: 0 PLC ± 1 PLC ±0.4 2 PLC ±0.30 3 PLC ± 4 PLC ± ANGLES ± FINISH -	NAME PLUG ASSEMBLY, UNSEALED, 12 POSITION 2X6, 0.64mm CONNECTOR	RESTRICTED TO -
MATERIAL		PRODUCT SPEC APPLICATION SPEC WEIGHT CUSTOMER DRAWING	SIZE A2 CAGE CODE 00779 DRAWING NO. 638394 SCALE 4:1 SHEET 2 OF 2 REV A

X-ON Electronics

Largest Supplier of Electrical and Electronic Components

Click to view similar products for [Automotive Connectors](#) category:

Click to view products by [TE Connectivity](#) manufacturer:

Other Similar products are found below :

[003-018-000](#) [60403001](#) [60993906-B](#) [M902-2131](#) [M902-2161](#) [M902-2344](#) [72.330.1035.1](#) [73.353.4028.0](#) [F119300-B](#) [F166900](#) [F258300-B](#)
[F358300-B](#) [F407400](#) [F444110](#) [F487000](#) [F509500B-B](#) [827153-1](#) [8N1515-32-24P](#) [9-1326729-8](#) [925474-1](#) [928905-1](#) [964562-4](#) [968782-1](#)
[GT17SA-8DS-HU](#) [98891-1012](#) [98947-1016](#) [12004147](#) [12004475-L](#) [12010290](#) [12015454](#) [12020219-B](#) [12041318-B](#) [12052225-L](#) [12052466](#)
[12064869](#) [12004327-B](#) [12015308](#) [12015384](#) [12015909](#) [1-21030-1](#) [12041254](#) [12041318](#) [12047946-B](#) [12047957](#) [12047957-L](#) [12059473](#)
[12066261](#) [12110546](#) [12110546-B](#) [12131792](#)