

LOC		DIST		REVISIONS			
ES	00	P	LTN	DESCRIPTION	DATE	DMN	APVD
		E2		REV PER ECR-12-015720	11SEP2012	CZ	SZ
		E3		REV PER ECR-13-004638	20MAR2013	ML	SZ

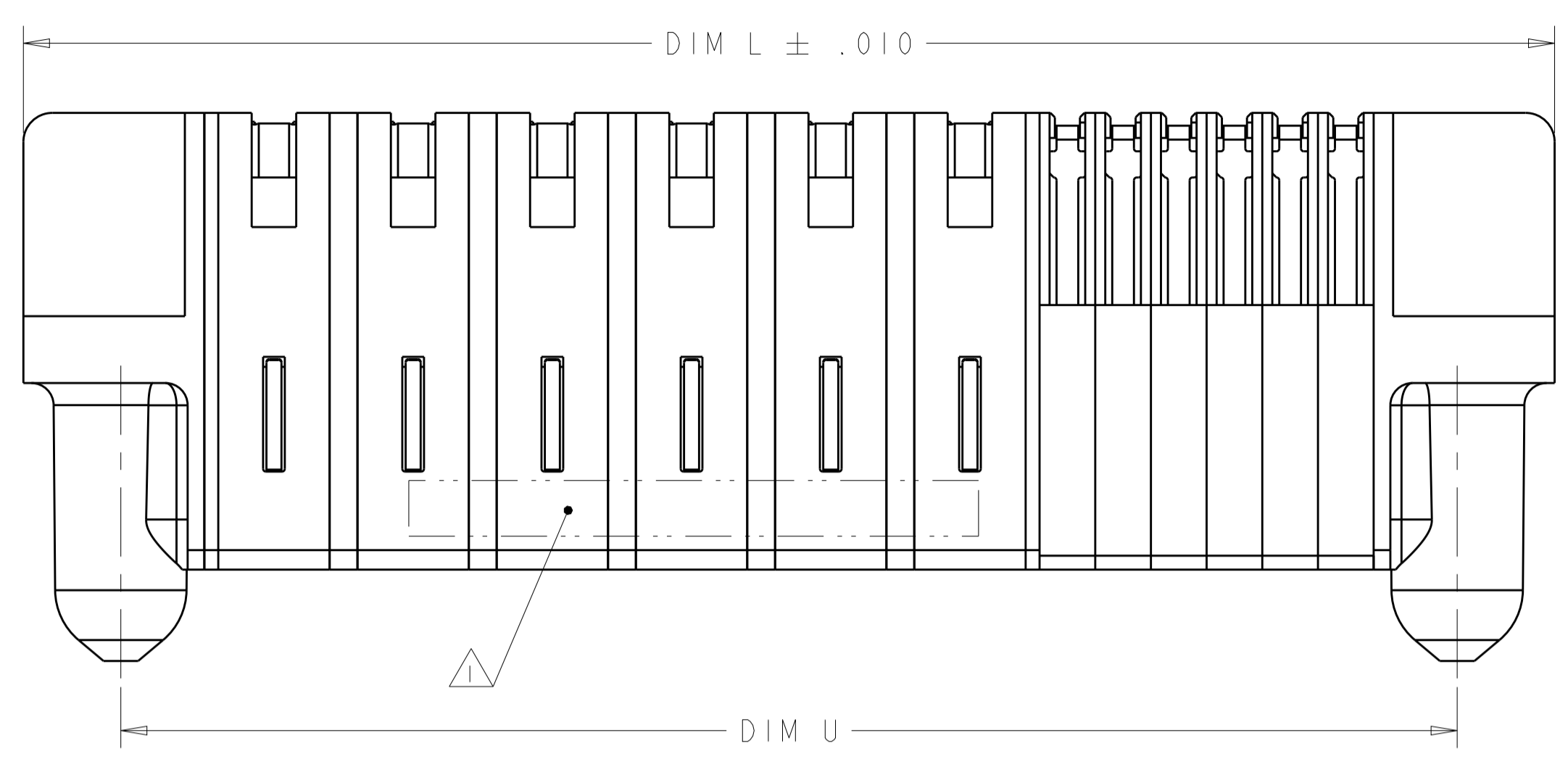

- 1 "AMP", PART NUMBER AND DATE CODE TO BE MARKED
- 2 MATERIAL: HOUSING - GLASS FILLED HIGH TEMP THERMO PLASTIC, UL94 V-0.
 SIGNAL CONTACT - HIGH CONDUCTIVITY COPPER ALLOY
 POWER CONTACT - HIGH CONDUCTIVITY COPPER ALLOY
- 3 CONTACT PLATING:
 NOBLE METAL PLATED ON THE CONTACT FUNCTIONAL AREA OF POWER AND SIGNAL CONTACTS.
- 4 MECHANICAL CONNECTOR KEEP OUT ZONE.
- 5 DATUM AND BASIC DIMENSIONS ESTABLISHED BY CUSTOMER.
- 6 PCB - ALL HOLE DIAMETERS ARE FINISHED HOLE SIZES
- 7 PCB - .0453±.0010 DRILLED HOLES PLATED WITH .0003 MIN Sn OVER .001 TO .003 Cu PLATING TO ACHIEVE A .040 DIAMETER HOLE

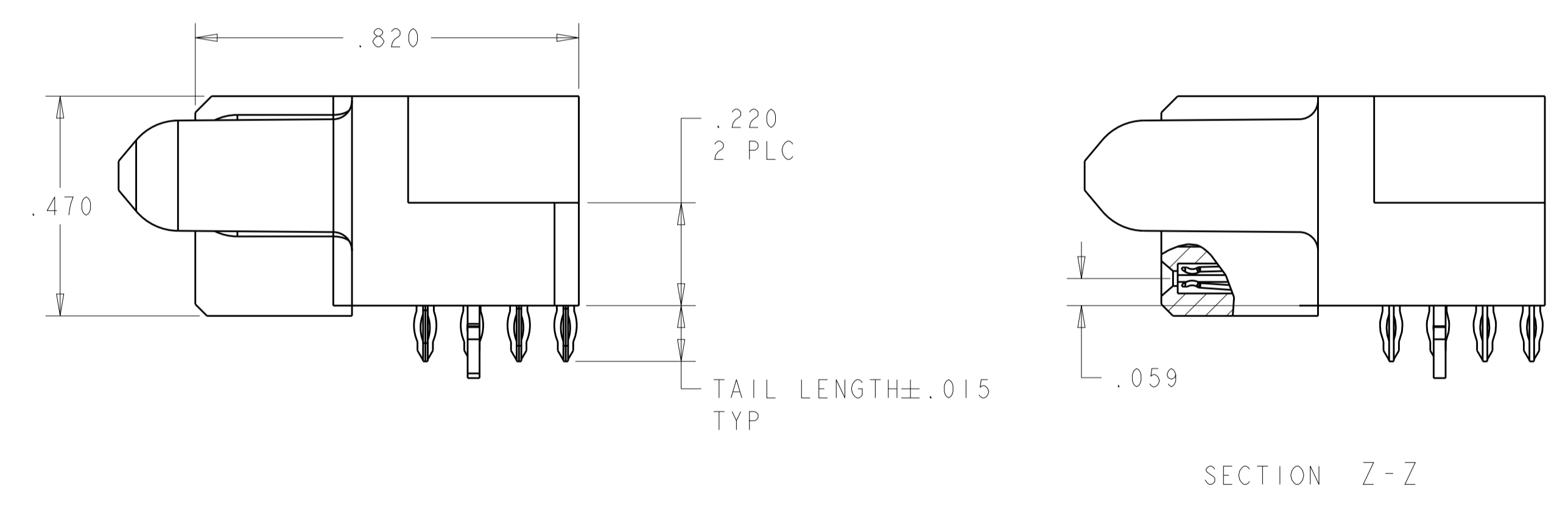
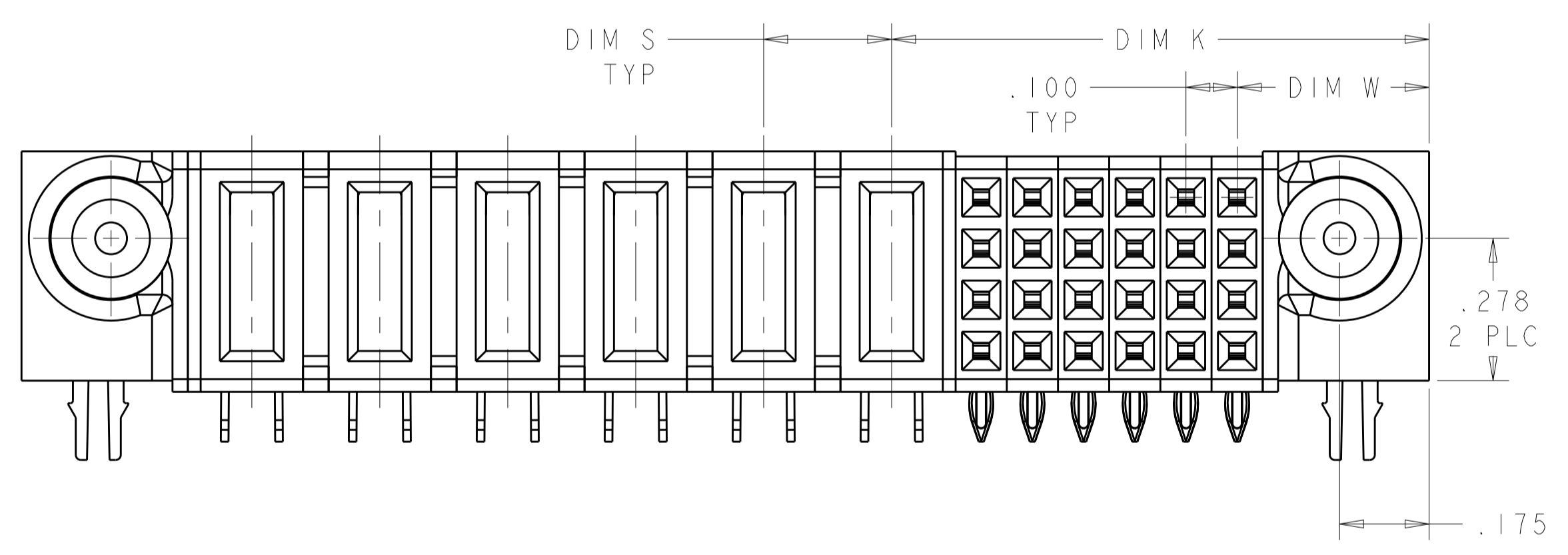

E2	.119	.375	1.600	.250	1.950	.750	12S + 4P	6450561-8
	.119	.375	4.650	.250	5.000	2.050	64S + 11P	6450561-7
	.165	.375	1.500	-	1.850	-	48S	6450561-5
	.119	.425	1.200	-	1.550	-	32S	6450561-4
	.119	.375	2.400	.250	2.750	1.050	24S + 6P	6450561-3
	TAIL LENGTH	DIM W	DIM U	DIM S	DIM L	DIM K	DESCRIPTION	PART NUMBER

THIS DRAWING IS A CONTROLLED DOCUMENT. DMN: CECILY.ZHOU 05JUL06
 CHK: S.ZHAO 05JUL06
 APVD: S.YAO

STE TE Connectivity

NAME: RIGHT ANGLE RECEPTACLE ASSEMBLY
 PRODUCT SPEC: 108-1973
 APPLICATION SPEC: 114-13038
 SIZE: A100779 C=6450561
 WEIGHT: -
 CUSTOMER DRAWING

DIMENSIONS: INCHES
 TOLERANCES UNLESS OTHERWISE SPECIFIED:
 0 PLC ±.
 1 PLC ±.01
 2 PLC ±.01
 3 PLC ±.005
 4 PLC ±.0020
 ANGLES ±.020

SCALE: 4:1 SHEET 1 OF 4 REV: E3

PART NUMBER	ROWS	POWER						SIGNAL					
		P6	P5	P4	P3	P2	P1	6	5	4	3	2	1
6450561-3	D C B A	RP	RP	RP	RP	RP	RP	D	D	D	D	D	D
		C	C	C	C	C	C	C	C	C	C	C	C
		B	B	B	B	B	B	B	B	B	B	B	B
		A	A	A	A	A	A	A	A	A	A	A	A
24S + 6P													

PART NUMBER	ROWS	SIGNAL											
		12	11	10	9	8	7	6	5	4	3	2	1
6450561-5	D C B A	DD	DD	DD	DD	DD	DD	DD	DD	DD	DD	DD	DD
		CC	CC	CC	CC	CC	CC	CC	CC	CC	CC	CC	CC
		BB	BB	BB	BB	BB	BB	BB	BB	BB	BB	BB	BB
		AA	AA	AA	AA	AA	AA	AA	AA	AA	AA	AA	AA
48S													

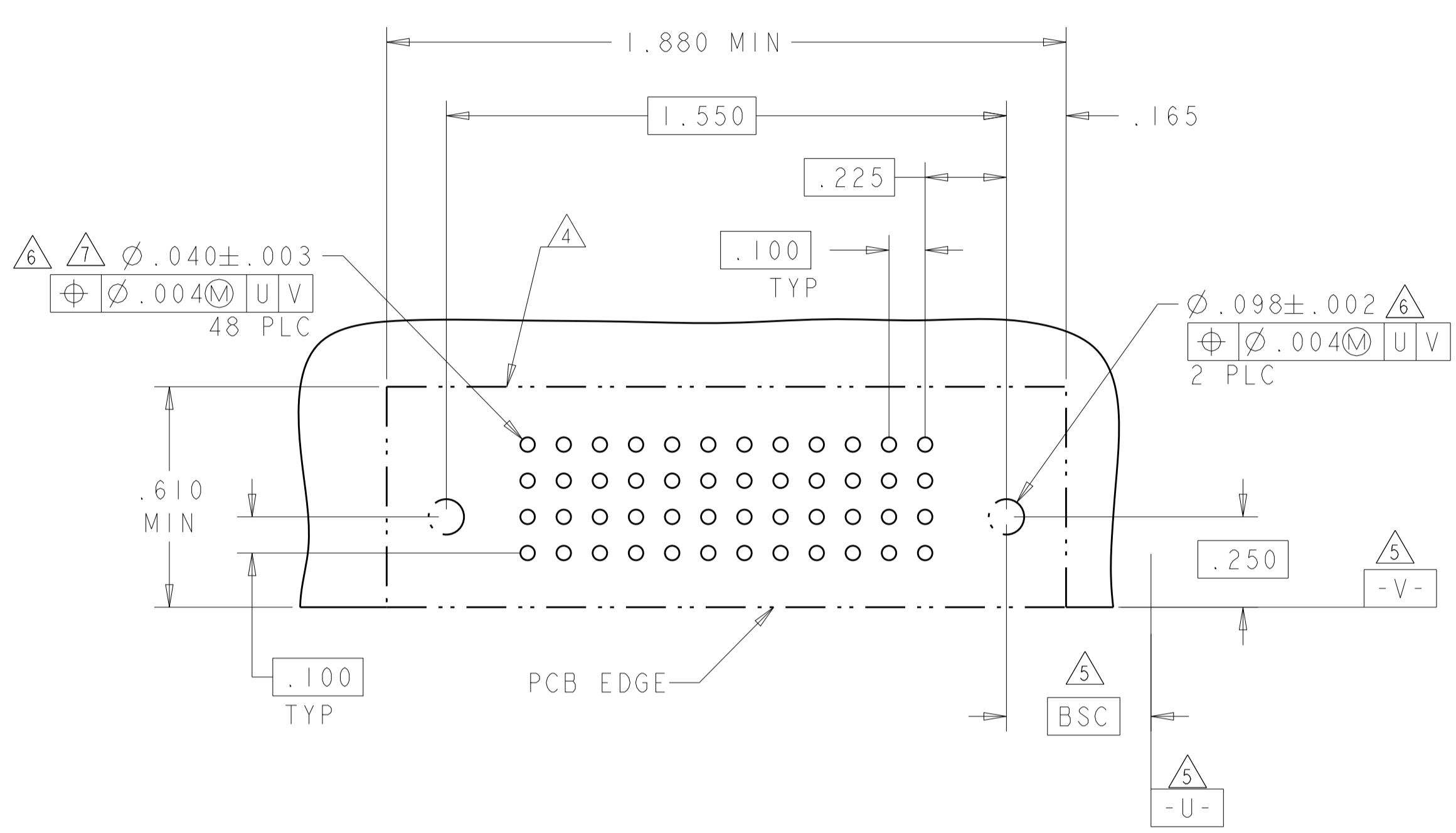
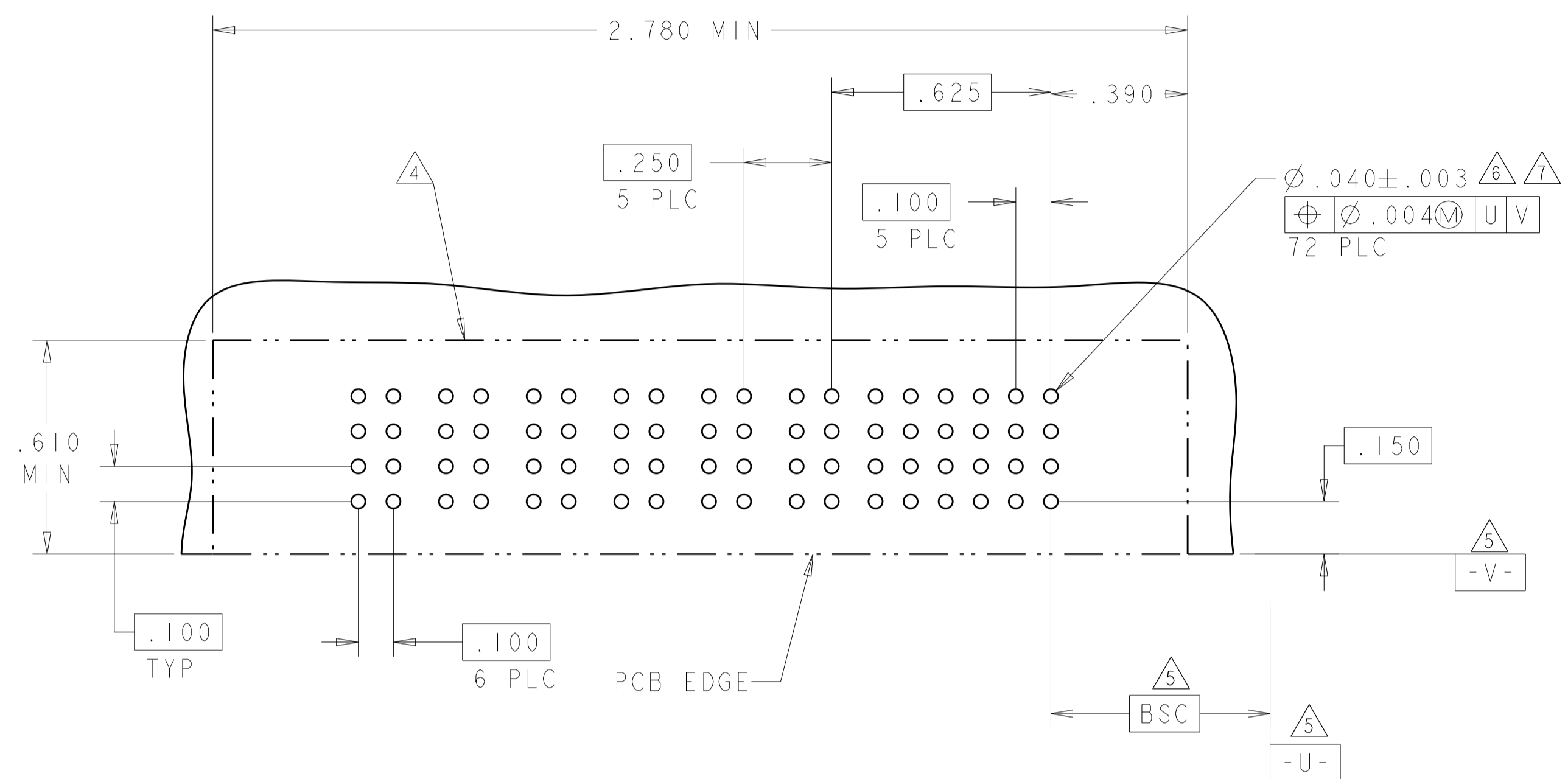

PART NUMBER	ROWS	SIGNAL							
		8	7	6	5	4	3	2	1
6450561-4	D C B A	D	D	D	D	D	D	D	D
		C	C	C	C	C	C	C	C
		B	B	B	B	B	B	B	B
		A	A	A	A	A	A	A	A
32S									

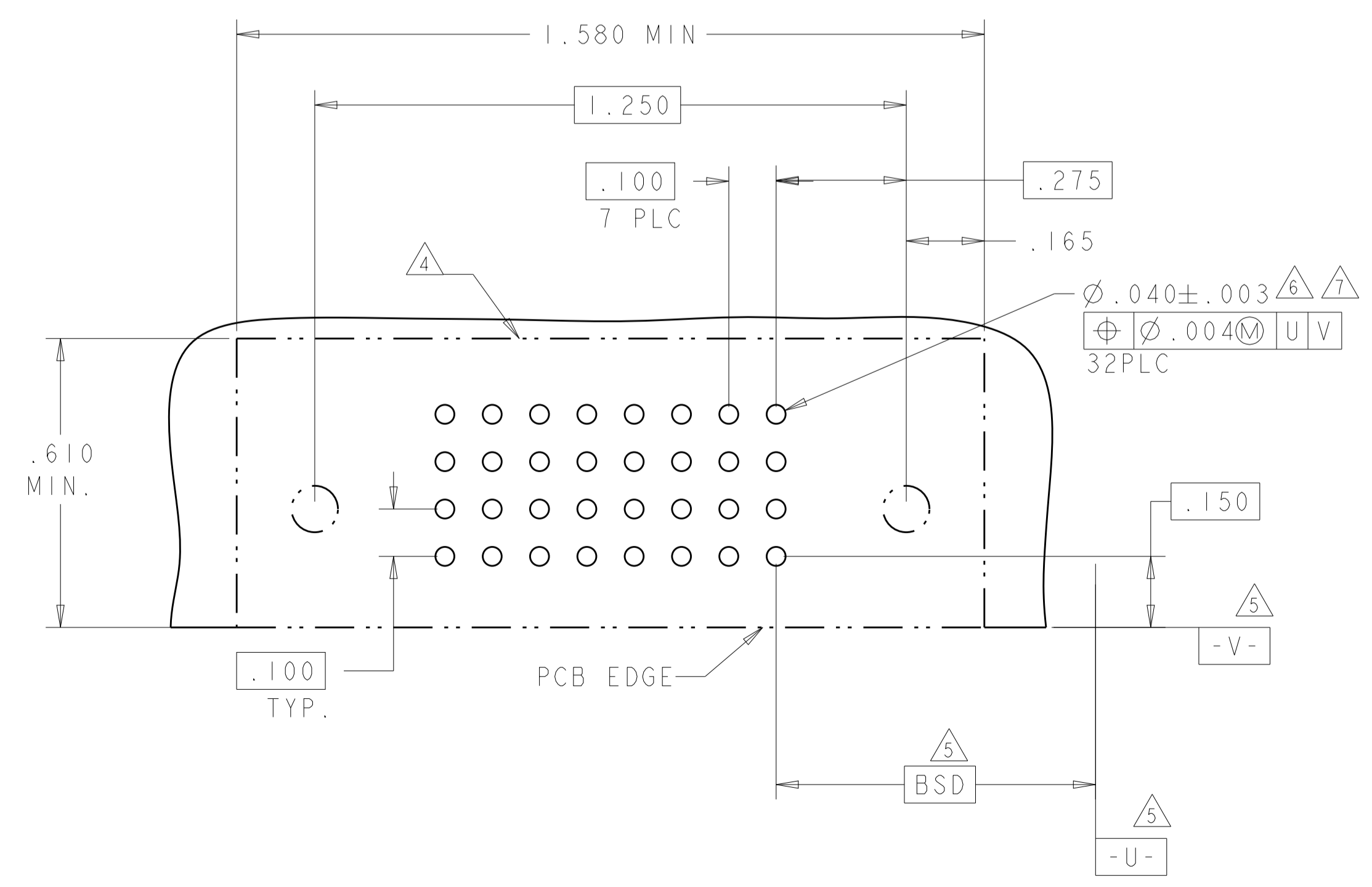

TAIL LENGTH	CODE	DESCRIPTION	ROW
.165	DD	SIGNAL CONTACT, PRESS-FIT	D
.165	CC	SIGNAL CONTACT, PRESS-FIT	C
.165	BB	SIGNAL CONTACT, PRESS-FIT	B
.165	AA	SIGNAL CONTACT, PRESS-FIT	A
.119	D	SIGNAL CONTACT, PRESS-FIT	D
.119	C	SIGNAL CONTACT, PRESS-FIT	C
.119	B	SIGNAL CONTACT, PRESS-FIT	B
.119	A	SIGNAL CONTACT, PRESS-FIT	A
.119	RS	POWER CONTACT, STD, PRESS FIT	-
.119	RP	POWER CONTACT, MFBL, PRESS FIT	-

THIS DRAWING IS A CONTROLLED DOCUMENT.		DWN: CECILY.ZHOU 05JUL06	TE Connectivity
DIMENSIONS: INCHES		CHK: S.ZHAO 05JUL06	
TOLERANCES UNLESS OTHERWISE SPECIFIED:		APVD: S.YAO	NAME: RIGHT ANGLE RECEPTACLE ASSEMBLY
0 PLC ±	1 PLC ±.01	PRODUCT SPEC	108-1973
2 PLC ±.01	3 PLC ±.005	APPLICATION SPEC	114-13038
4 PLC ±.0020	ANGLES ±.020	RESTRICTED TO	A100779C=6450561
MATERIAL: 2	FINISH: 3	WEIGHT:	CUSTOMER DRAWING
SCALE: 4:1		SHEET: 2 OF 4	REV: E3

LOC	DIST	REVISIONS					
		P	LTN	DESCRIPTION	DATE	DMN	APVD
ES	00	-	-	SEE SHEET 1	-	-	-

PART NUMBER	ROWS	POWER										SIGNAL																	
		P11	P10	P9	P8	P7	P6	P5	P4	P3	P2	P1	16	15	14	13	12	11	10	9	8	7	6	5	4	3	2	1	
6450561-7	D											D	D	D	D	D	D	D	D	D	D	D	D	D	D	D	D	D	
	C	RS	RS	RS	RS	RS	RS	RS	RS	RS	RS	C	C	C	C	C	C	C	C	C	C	C	C	C	C	C	C	C	
	B											B	B	B	B	B	B	B	B	B	B	B	B	B	B	B	B	B	
	A											A	A	A	A	A	A	A	A	A	A	A	A	A	A	A	A	A	
64S + IIP																													

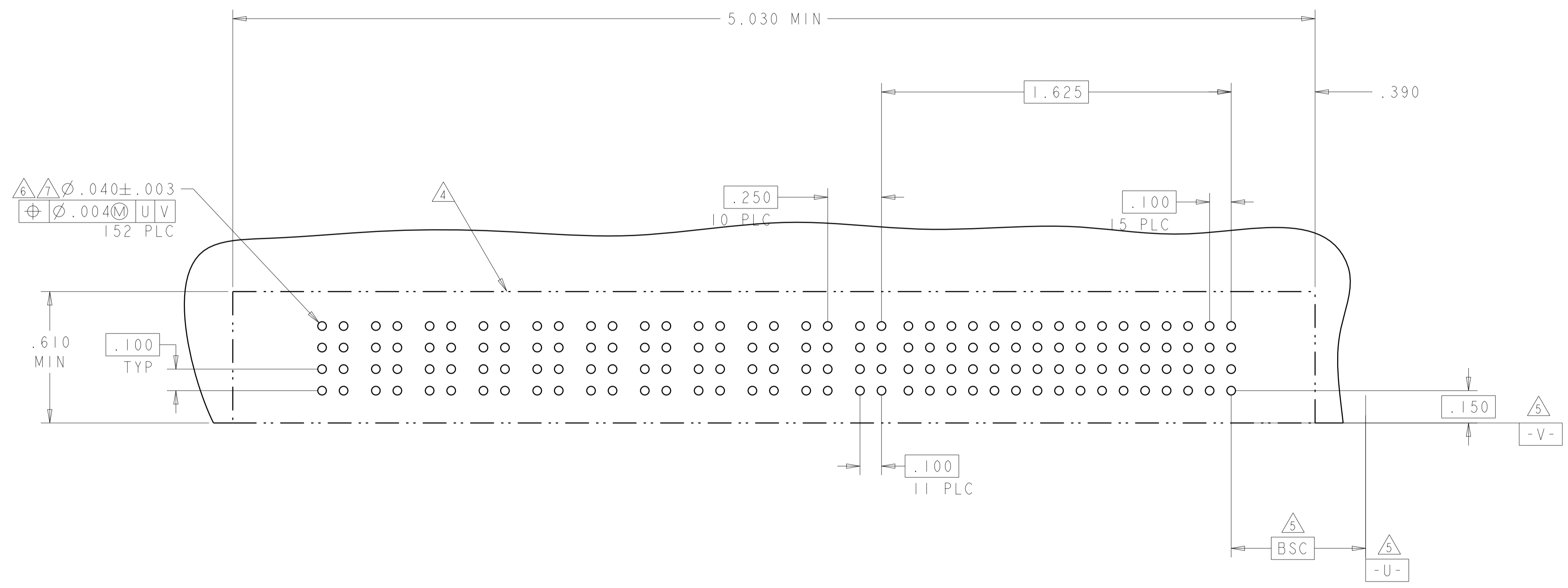

THIS DRAWING IS A CONTROLLED DOCUMENT.		DMN: CECILY.ZHOU 05JUL06	TE Connectivity
DIMENSIONS: INCHES		CHK: S.ZHAO 05JUL06	
TOLERANCES UNLESS OTHERWISE SPECIFIED: 0 PLC ±. 1 PLC ±. 2 PLC ±.01 3 PLC ±.005 4 PLC ±.0020 ANGLES ±.7°		APVD: S.YAO	NAME: RIGHT ANGLE RECEPTACLE ASSEMBLY
		PRODUCT SPEC: 108-1973	PRODUCT SPEC: MULTI-BEAM XL
MATERIAL: -		APPLICATION SPEC: 114-13038	SIZE: A100779
FINISH: -		WEIGHT: -	CAGE CODE: 6450561
		CUSTOMER DRAWING	RESTRICTED TO: -
		SCALE: 4:1	SHEET 3 OF 4
			REV: E3

X-ON Electronics

Largest Supplier of Electrical and Electronic Components

Click to view similar products for [Power to the Board](#) category:

Click to view products by [TE Connectivity](#) manufacturer:

Other Similar products are found below :

[10131318-08512GRLF](#) [6450171-4](#) [6450552-7](#) [6600323-8](#) [6643429-1](#) [6646040-2](#) [6651939-1](#) [6766604-1](#) [120959-1](#) [1393557-2](#) [1393532-2](#)
[1393532-3](#) [1393532-4](#) [1393557-1](#) [1600812-5](#) [1-6450861-2](#) [1645595-1](#) [1743490-1](#) [1744132-7](#) [1761122-1](#) [1766169-1](#) [1766250-1](#) [18362](#)
[1892109-1](#) [1-967627-6](#) [2226808-1](#) [2-6450860-5](#) [2-6450860-6](#) [2-6450870-0](#) [93003-0502](#) [953552-1](#) [1-6450161-4](#) [1-6450850-6](#) [1645526-2](#) [1-](#)
[6600130-0](#) [1743419-1](#) [1766150-1](#) [2005243-2](#) [211110-1](#) [2-6600130-2](#) [TE34-12-16P-F0](#) [51700-10201602AALF](#) [5-6450830-6](#) [5646956-4](#)
[36662-0005](#) [40585-3000](#) [4-6450830-9](#) [4-6600333-3](#) [51142-0214](#) [10125416-4050LF](#)