

LOC	DIST	REVISIONS					
		P	LTN	DESCRIPTION	DATE	DMN	APVD
ES	00	G5		ADD NEW DASH NUMBER 1-8	11AUG2014	AL	SZ

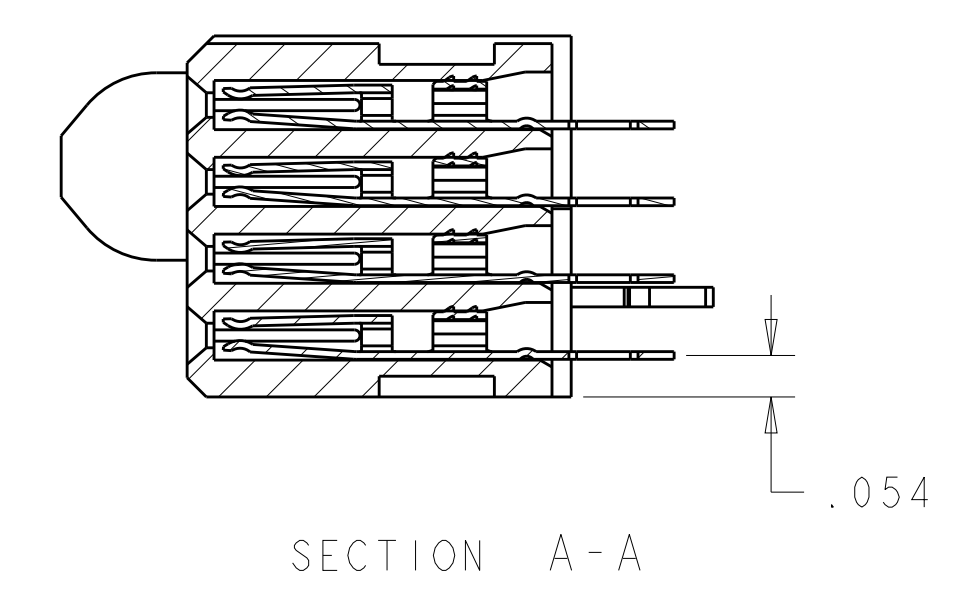
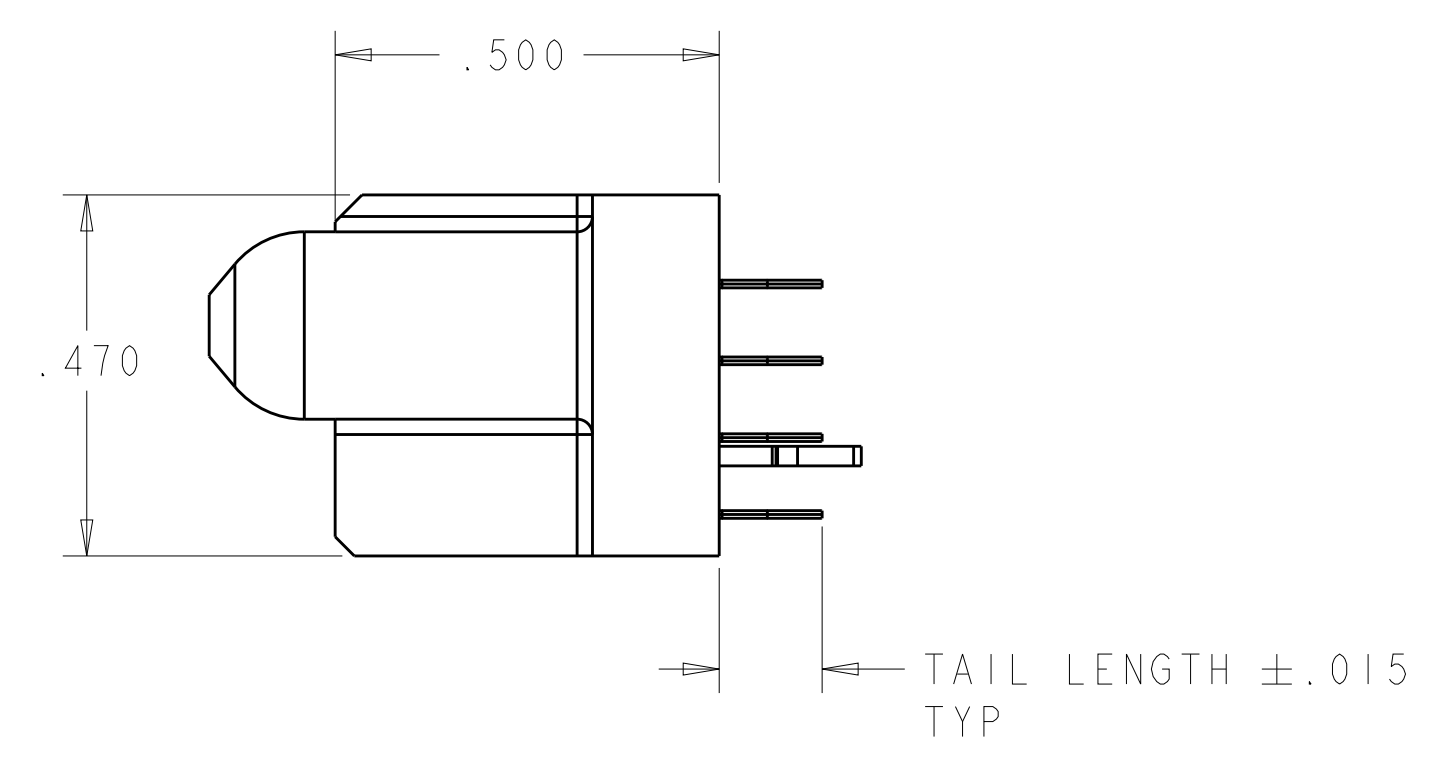
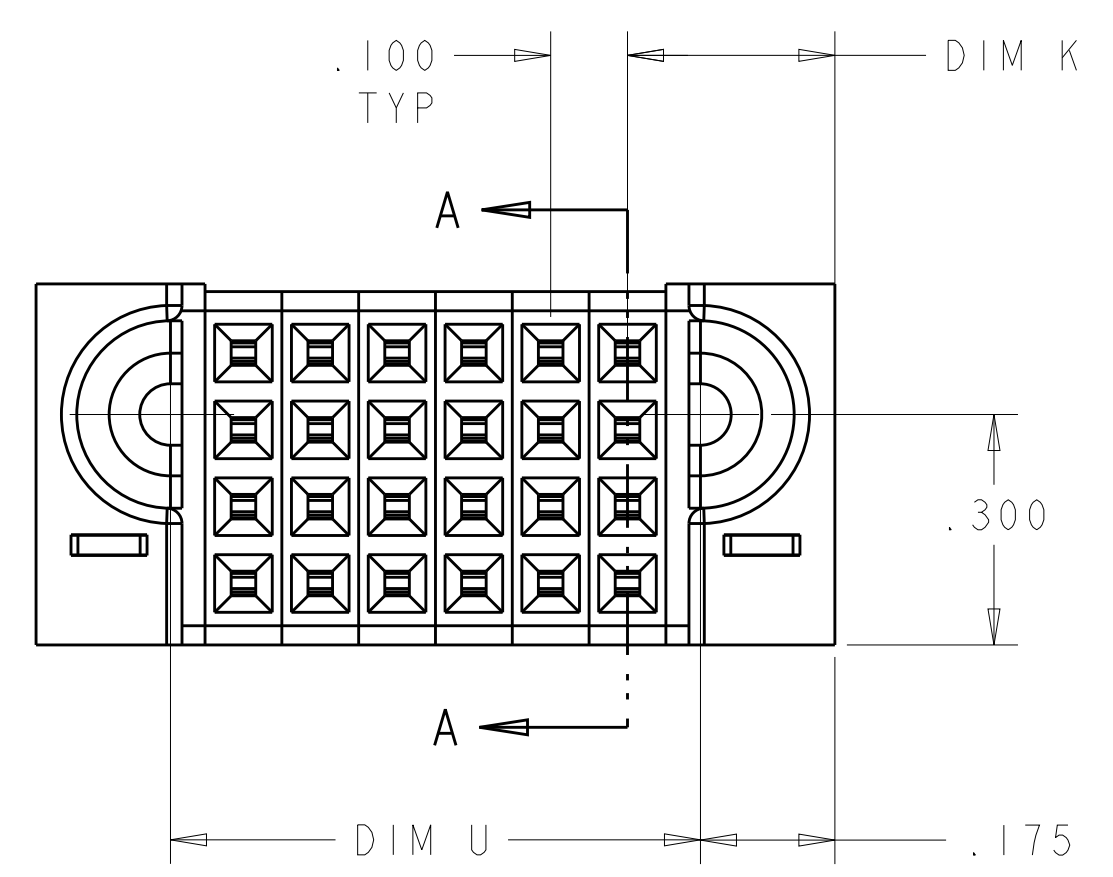
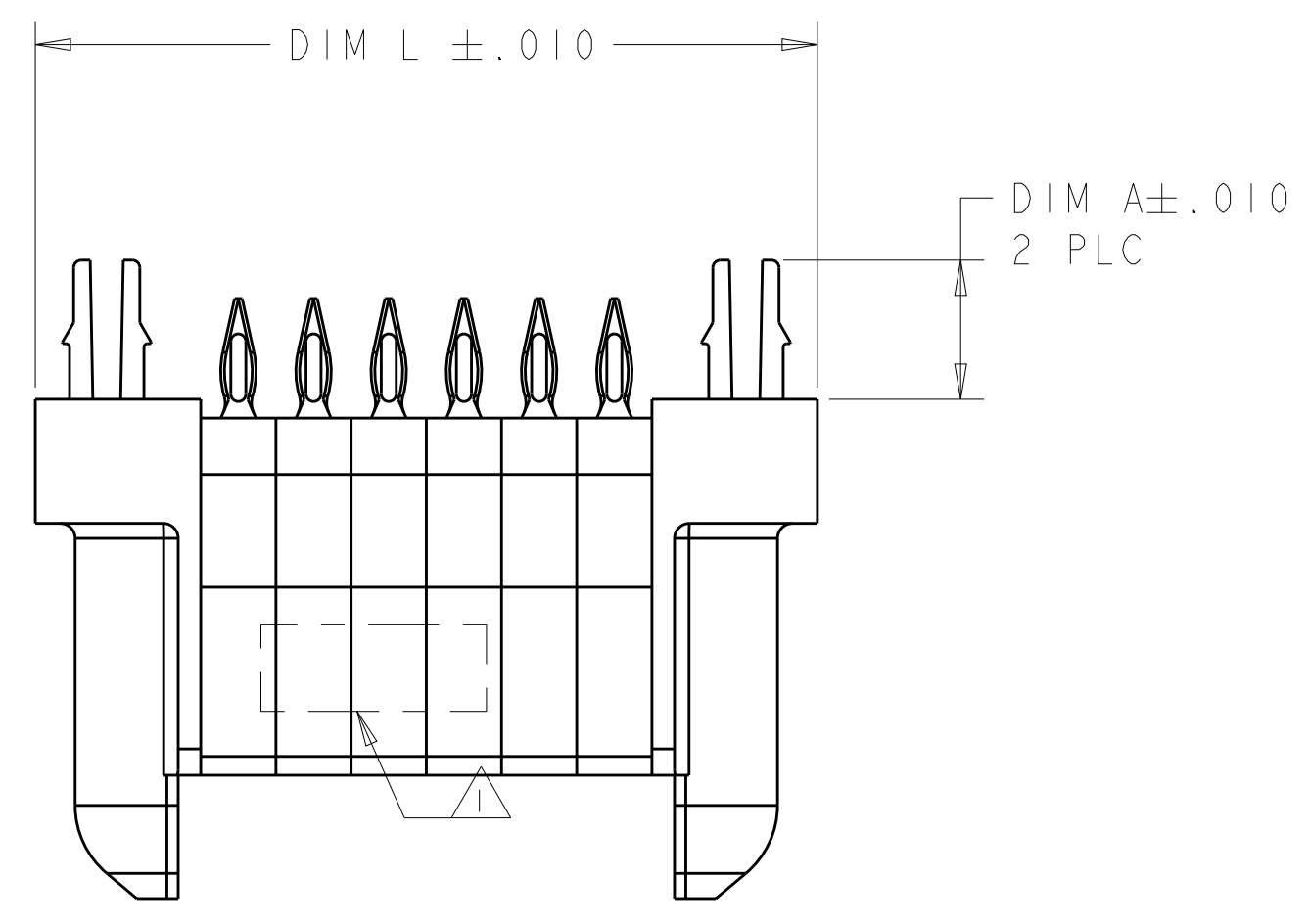
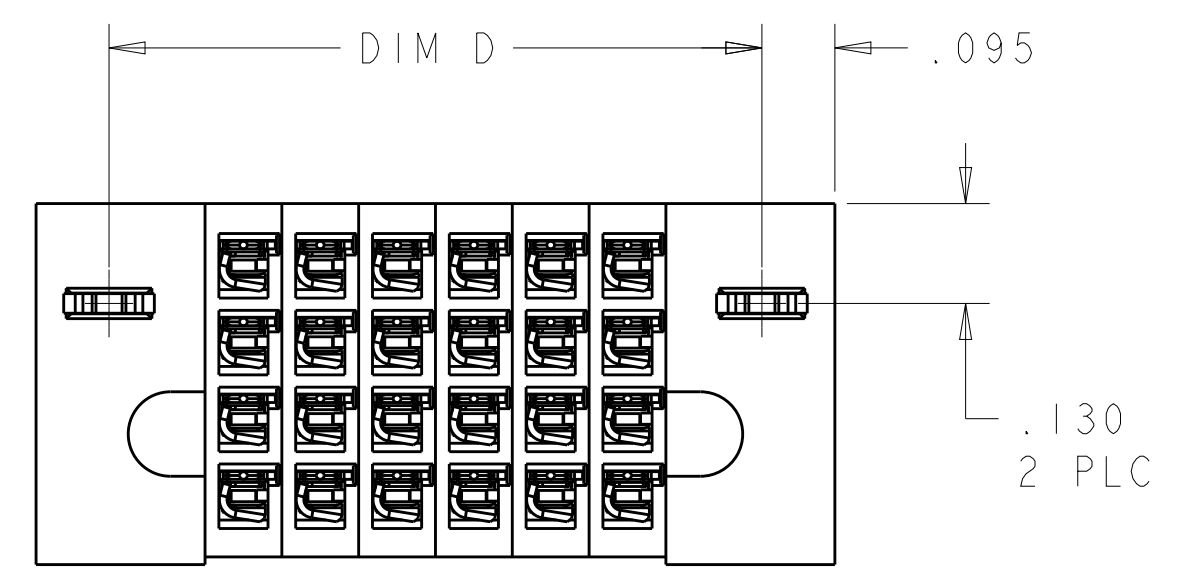

- 1 "AMP", PART NUMBER AND DATE CODE TO BE MARKED IN AREA SHOWN PARTS UNDER 2.00 LONG MAY BE MARKED ON BOTH SIDES
- 2 MATERIAL: HOUSING - GLASS FILLED HIGH TEMP THERMO PLASTIC, UL94 V-0  
 SIGNAL CONTACT - HIGH CONDUCTIVITY COPPER ALLOY  
 POWER CONTACT - HIGH CONDUCTIVITY COPPER ALLOY
- 3 CONTACT PLATING: NOBLE METAL PLATING ON CONTACT FUNCTIONAL AREA OF POWER AND SIGNAL CONTACTS
- 4 MECHANICAL CONNECTOR KEEP OUT ZONE
- 5 DATUM AND BASIC DIMENSIONS ESTABLISHED BY CUSTOMER
- 6 PCB - ALL HOLE DIAMETERS ARE FINISHED HOLE SIZES
- 7 PCB - 0.0453 ±.0010 DRILLED HOLES PLATED WITH .0003 MIN Sn OVER .001 TO .003 Cu PLATING TO ACHIEVE A .040 ±.0030 HOLE
- 8 FOR "S+P" CONFIGURATION ,VARIABLE DIMENSIONS PLEASE REFER TO SHEET 2
- 9 FOR "S+LP+P" CONFIGURATION ,VARIABLE DIMENSIONS PLEASE REFER TO SHEET 2
- 10 VARIABLE DIMENSION REFER TO THE DIMENSION ON CORRRESPONDING MODEL UNDER THE PCB

THIS DRAWING IS A CONTROLLED DOCUMENT.		DMN C. ZHOU CHK S. ZHAO	20JUN2012 20JUN2012	TE Connectivity
DIMENSIONS: INCHES	TOLERANCES UNLESS OTHERWISE SPECIFIED:	APVD	NAME	
0 PLC ±. 1 PLC ±. 2 PLC ±. 3 PLC ±.005 4 PLC ±.0020 ANGLES ±.7°	PRODUCT SPEC 108-2292 APPLICATION SPEC 114-13251	VERTICAL RECEPTACLE ASSEMBLY WITH SHORT GUIDE, PRESS FIT MULTI-BEAM XLE		
MATERIAL	FINISH	WEIGHT	SIZE	RESTRICTED TO
			A100779C=6450861	
Customer Drawing		SCALE	SHEET	REV
		1:1	11	G5

LOC		DIST		REVISIONS				
ES	00	P	LTH	DESCRIPTION	DATE	DWN	APVD	
		-		SEE SHEET 1				

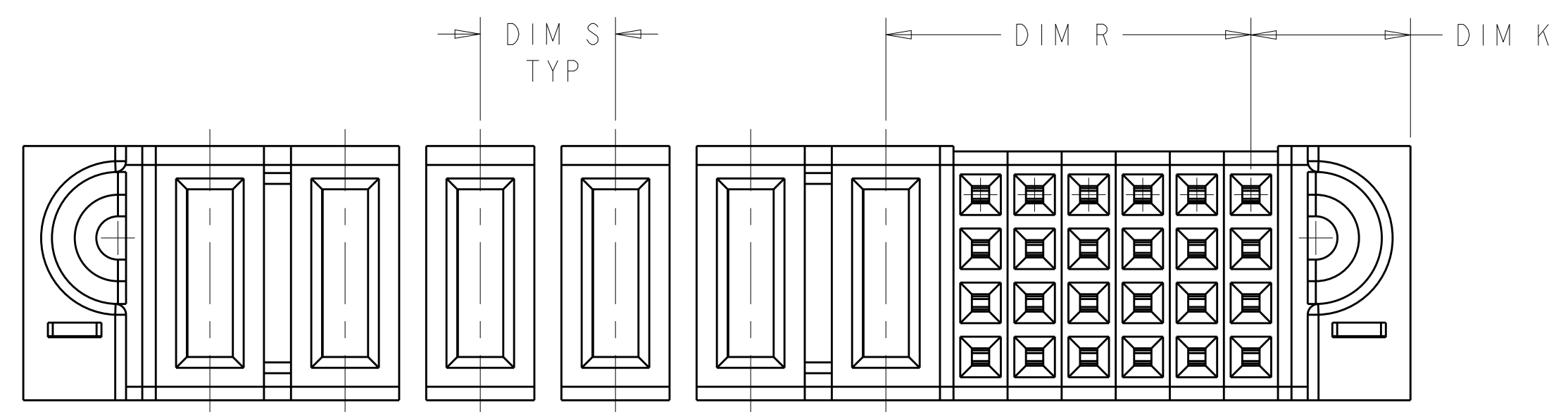

△ FOR "S + P" CONFIGURATION  
 UNSPECIFIED DIMENSIONS REFER TO SHEET 1.

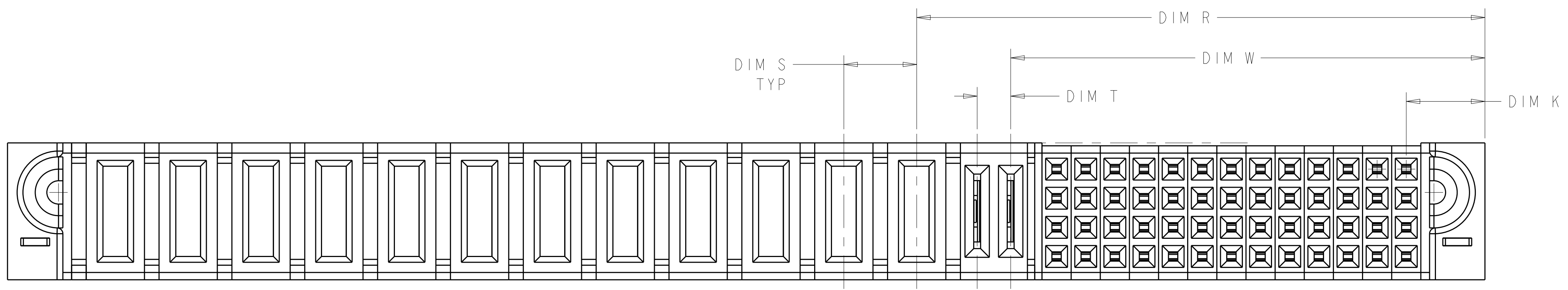

△ FOR "S + LP + P" CONFIGURATION  
 UNSPECIFIED DIMENSIONS REFER TO SHEET 1.

.185	-	-	-	-	1.640	1.290	1.450	.270	48S	1-6450861-8
.128	-	-	△	.475 △	1.990	1.640	1.800	.270	16S + 4P	1-6450861-7
.185	-	-	-	-	.840	.490	.650	.270	16S	1-6450861-6
.185	-	-	.200 △	.675 △	1.865	1.515	1.675	.270	24S + 4P	1-6450861-5
.185	-	-	-	-	2.140	1.790	1.950	.320	64S	1-6450861-4
.185	-	-	.250 △	.475 △	3.840	3.490	3.650	.295	16S + 12P	1-6450861-3
.185	-	-	.300 △	.875 △	2.465	2.115	2.275	.320	32S + 4ACP	1-6450861-2
.185	-	-	.250 △	.475 △	3.340	2.990	3.150	.295	16S + 10P	1-6450861-1
.185	-	-	.250 △	.675 △	2.040	1.690	1.850	.270	24S + 4P	6450861-9
.185	-	-	.250 △	.475 △	1.440	1.090	1.250	.320	16S + 2P	6450861-8
.185	.115 △	1.6275 △	.250 △	1.950 △	5.070	4.720	4.880	.270	52S + 2LP + 12P	6450861-6
.185	-	-	.250 △	.675 △	3.065	2.715	2.875	.295	24S + 8P	6450861-5
.185	-	-	.250 △	.675 △	2.565	2.215	2.375	.295	24S + 6P	6450861-4
.185	-	-	.250 △	.675 △	2.565	2.215	2.375	.295	24S + 6P	6450861-3
.185	-	-	-	-	2.240	1.890	2.050	.270	72S	6450861-2
.185	-	-	-	-	1.040	.690	.850	.270	24S	6450861-1
DIM A	DIM T	DIM W	DIM S	DIM R	DIM L	DIM U	DIM D	DIM K	DESCRIPTION	PART NUMBER

THIS DRAWING IS A CONTROLLED DOCUMENT. DWN: C. ZHOU, 08082008  
 CHK: S. ZHAO, 08082008

STE TE Connectivity

VERVIEWAREBERSSEMBASSEMBLY  
 W WITH ISHFOR TO LIGLIDESE,, HRESSSS FFIIT  
 MULT I HLELAM HLELAM XLE

108-2292  
 APPLICATION SPEC

114-13058  
 WEIGHT

A100779C=6450861

CUSTOMER DRAWING SCALE 4:1 SHEET 2 OF 11 REV 66



LOC	DIST	REVISIONS					
ES	00	P	LTN	DESCRIPTION	DATE	DWN	APVD
		-		SEE SHEET 1			

PART NUMBER	ROWS	SIGNAL																	
		18	17	16	15	14	13	12	11	10	9	8	7	6	5	4	3	2	1
6450861-2	D C B A	AP	AP	AP	AP	AP	AP	AP	AP	AP	AP	AP	AP	AP	AP	AP	AP	AP	AP
		AP	AP	AP	AP	AP	AP	AP	AP	AP	AP	AP	AP	AP	AP	AP	AP	AP	AP
		AP	AP	AP	AP	AP	AP	AP	AP	AP	AP	AP	AP	AP	AP	AP	AP	AP	AP
		AP	AP	AP	AP	AP	AP	AP	AP	AP	AP	AP	AP	AP	AP	AP	AP	AP	AP
72S																			

PART NUMBER	ROWS	POWER						SIGNAL					
		P6	P5	P4	P3	P2	P1	6	5	4	3	2	1
6450861-4	D C B A	GS	GS	GS	GS	GS	GS	AP	AP	AP	AP	AP	AP
		GS	GS	GS	GS	GS	GS	AP	AP	AP	AP	AP	AP
		GS	GS	GS	GS	GS	GS	AP	AP	AP	AP	AP	AP
		GS	GS	GS	GS	GS	GS	AP	AP	AP	AP	AP	AP
24S + 6P													

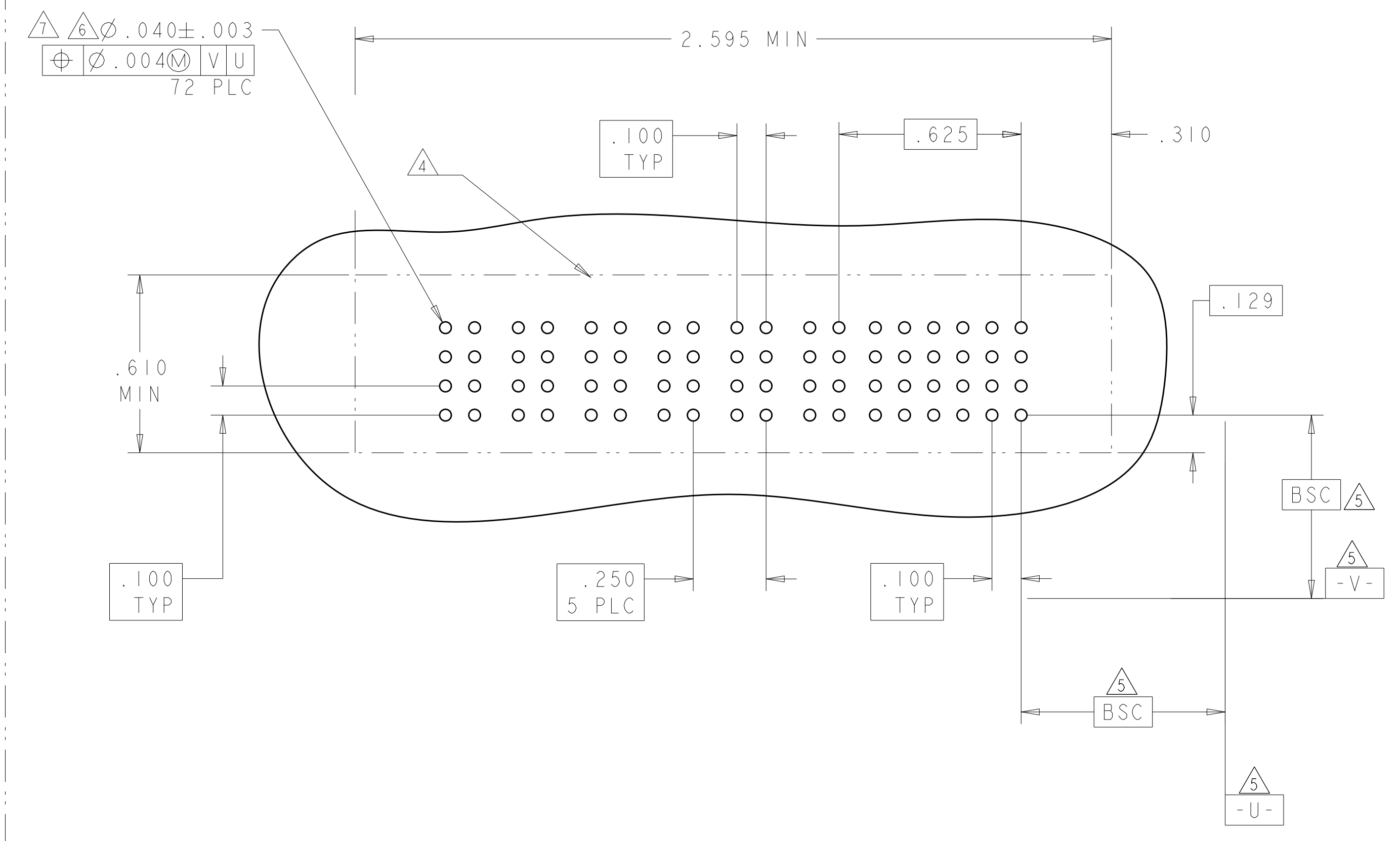
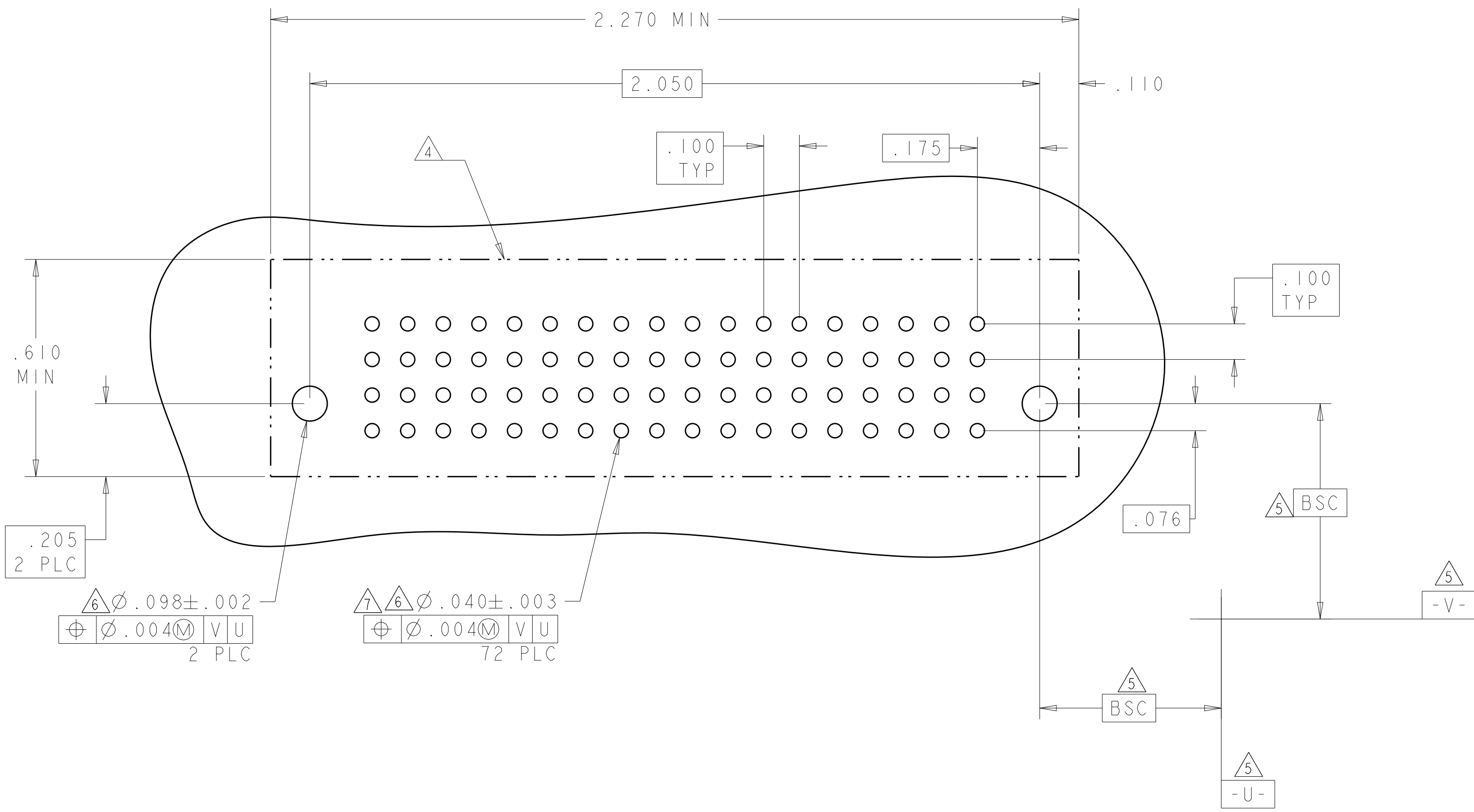

THIS DRAWING IS A CONTROLLED DOCUMENT.		DWN C. ZHOU	80802008	<b>STE</b> TE Connectivity
DIMENSIONS: INCHES		CHK S. ZHAO	80802008	
TOLERANCES UNLESS OTHERWISE SPECIFIED:		APVD S. YAO		NAME VERVE GABE REVERSE SMD ASSEMBLY
0 PLC ±.01		PRODUCT SPEC		W/ WITH ISH FOR TO LOUDEDSE, HRESSS FIHT
1 PLC ±.01		APPLICATION SPEC		MULTI-MELAM-MELAM XLE
2 PLC ±.01		SIZE	114-13058	CAGE CODE DRAWING NO
3 PLC ±.005		RESTRICTED TO		A100779C=6450861
4 PLC ±.002		SCALE	4:1	SHEET 4 OF 11
ANGLES ±.2°		REV	66	
MATERIAL	FINISH	WEIGHT		
CUSTOMER DRAWING				

LOC	DIST	REVISIONS			
P	LTN	DESCRIPTION	DATE	DMN	APVD
-	-	SEE SHEET 1	-	-	-

PART NUMBER	ROWS	POWER								SIGNAL					
		P8	P7	P6	P5	P4	P3	P2	P1	6	5	4	3	2	1
6450861-5	D C B A	GS	GS	GS	GS	GS	GS	GS	GS	AP	AP	AP	AP	AP	AP
		GS	GS	GS	GS	GS	GS	GS	GS	AP	AP	AP	AP	AP	AP
		GS	GS	GS	GS	GS	GS	GS	GS	AP	AP	AP	AP	AP	AP

24S + 8P

PART NUMBER	ROWS	POWER												SIGNAL																							
		P12	P11	P10	P9	P8	P7	P6	P5	P4	P3	P2	P1	LP2	LPI	13	12	11	10	9	8	7	6	5	4	3	2	1									
6450861-6	D C B A	GS	GS	GS	GS	GS	GS	GS	GS	GS	GS	GS	GS	GS	LSI	LSI	AP	AP	AP	AP	AP	AP	AP	AP	AP	AP	AP	AP	AP	AP	AP	AP	AP	AP	AP	AP	AP
		GS	GS	GS	GS	GS	GS	GS	GS	GS	GS	GS	GS	GS	LSI	LSI	AP	AP	AP	AP	AP	AP	AP	AP	AP	AP	AP	AP	AP	AP	AP	AP	AP	AP	AP	AP	AP
		GS	GS	GS	GS	GS	GS	GS	GS	GS	GS	GS	GS	GS	LSI	LSI	AP	AP	AP	AP	AP	AP	AP	AP	AP	AP	AP	AP	AP	AP	AP	AP	AP	AP	AP	AP	AP

52S + 2LP + 12P

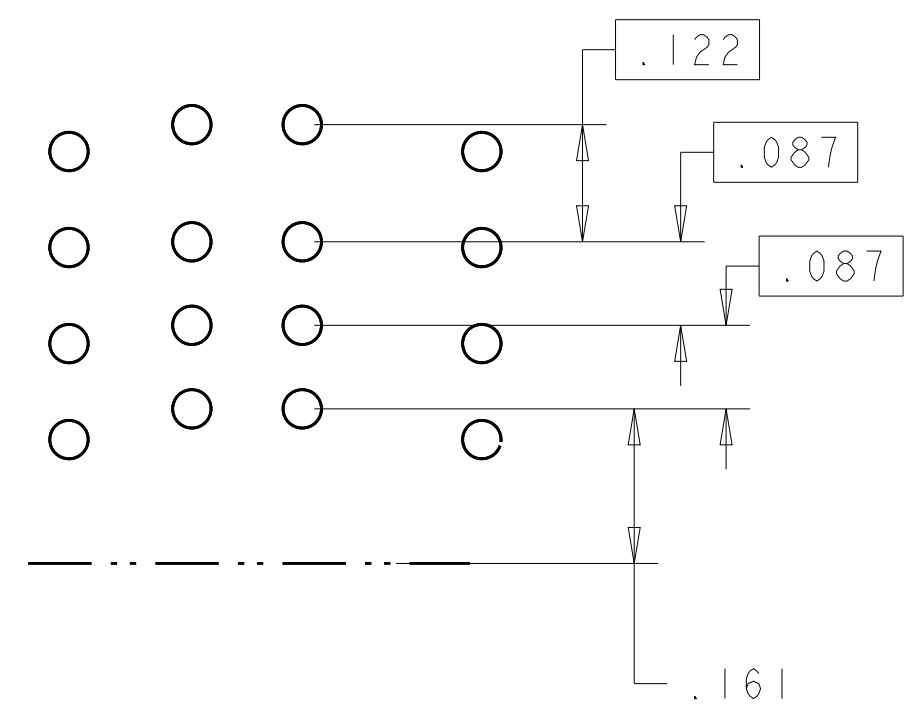
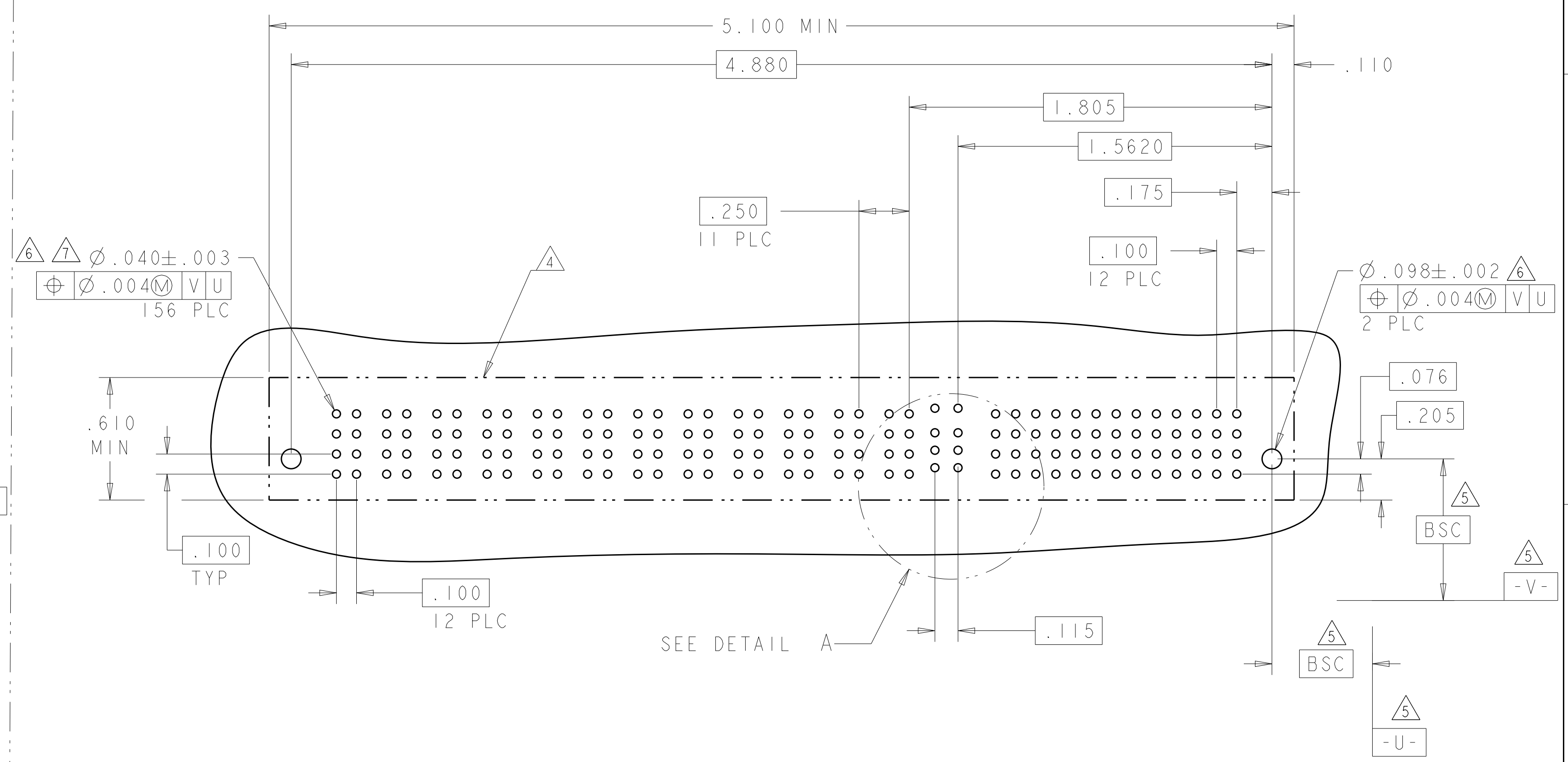
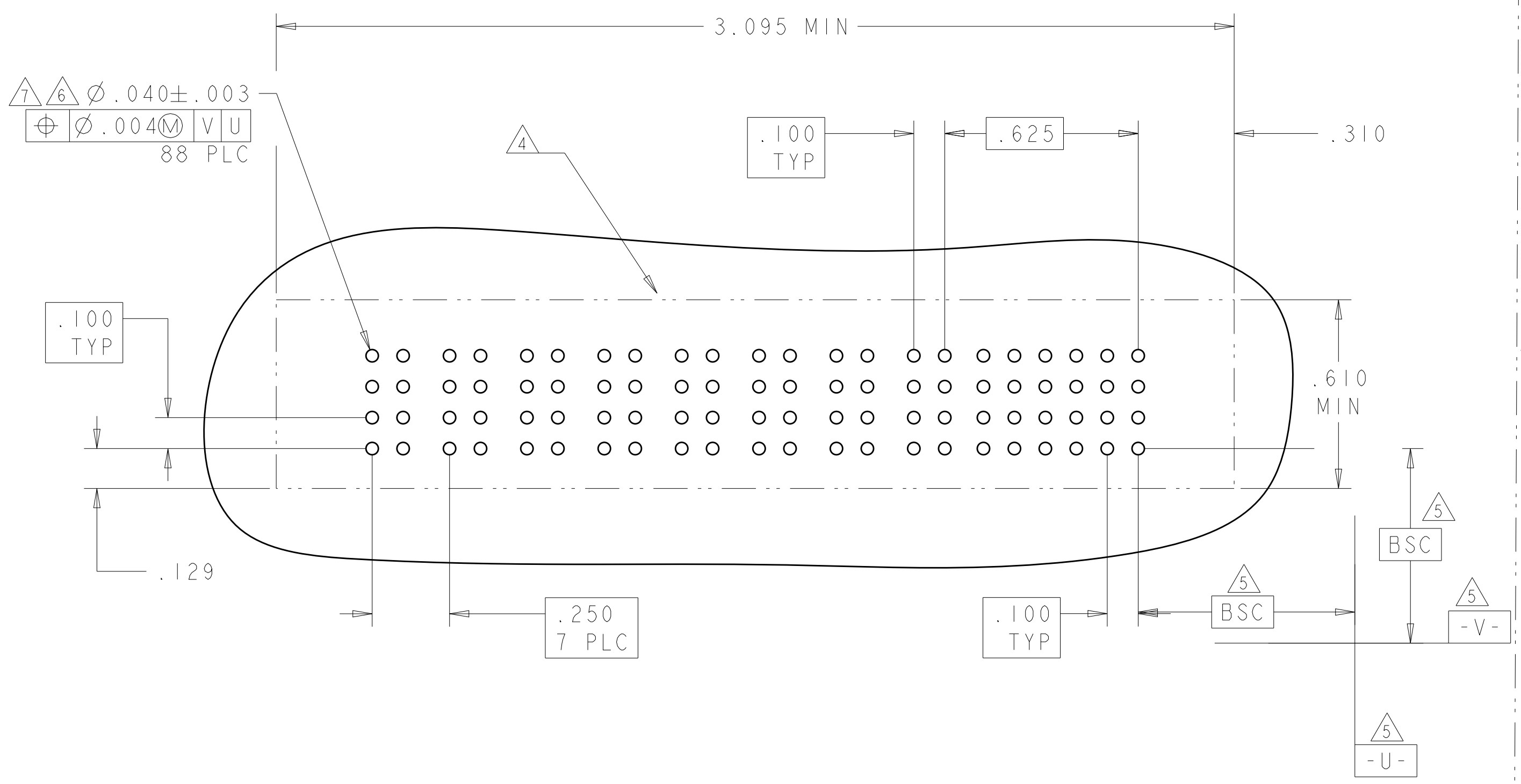

DETAIL A  
SCALE 5:1

THIS DRAWING IS A CONTROLLED DOCUMENT.		DMN C. ZHOU	80602008	<b>STE</b> TE Connectivity
DIMENSIONS: INCHES		CHK S. ZHAO	80602008	
TOLERANCES UNLESS OTHERWISE SPECIFIED:		APVD S. YAO	NAME	VERVIEW REVERSE ASSEMBLY
0 PLC ± .01		PRODUCT SPEC	108-2292	W/ WITH IS FOR TO LOUDEDSE, PRESSS FRIT
1 PLC ± .01		APPLICATION SPEC	114-13058	MULTI-MELEM-HELEM XLE
2 PLC ± .005		SIZE	114-13058	
3 PLC ± .002		WEIGHT	A100779	C=6450861
4 PLC ± .002		SCALE	4:1	SHEET 5 OF 11
ANGLES ± .2°		FINISH		REV 66
MATERIAL		CUSTOMER DRAWING		

LOC	DIST	REVISIONS			
P	LTN	DESCRIPTION	DATE	DWN	APVD
ES	00	SEE SHEET 1			

PART NUMBER	ROWS	POWER		SIGNAL			
		P2	P1	4	3	2	1
6450861-8	D C B A	GS	GS	AP	AP	AP	AP
				AP	AP	AP	AP
				AP	AP	AP	AP
				AP	AP	AP	AP
16S + 2P		HD		HD			

PART NUMBER	ROWS	POWER				SIGNAL					
		P4	P3	P2	P1	6	5	4	3	2	1
6450861-9	D C B A	GP	GP	GP	GP	AP	AP	AP	AP	AP	AP
						AP	AP	AP	AP	AP	AP
						AP	AP	AP	AP	AP	AP
						AP	AP	AP	AP	AP	AP
24S + 4P		HD		HD							

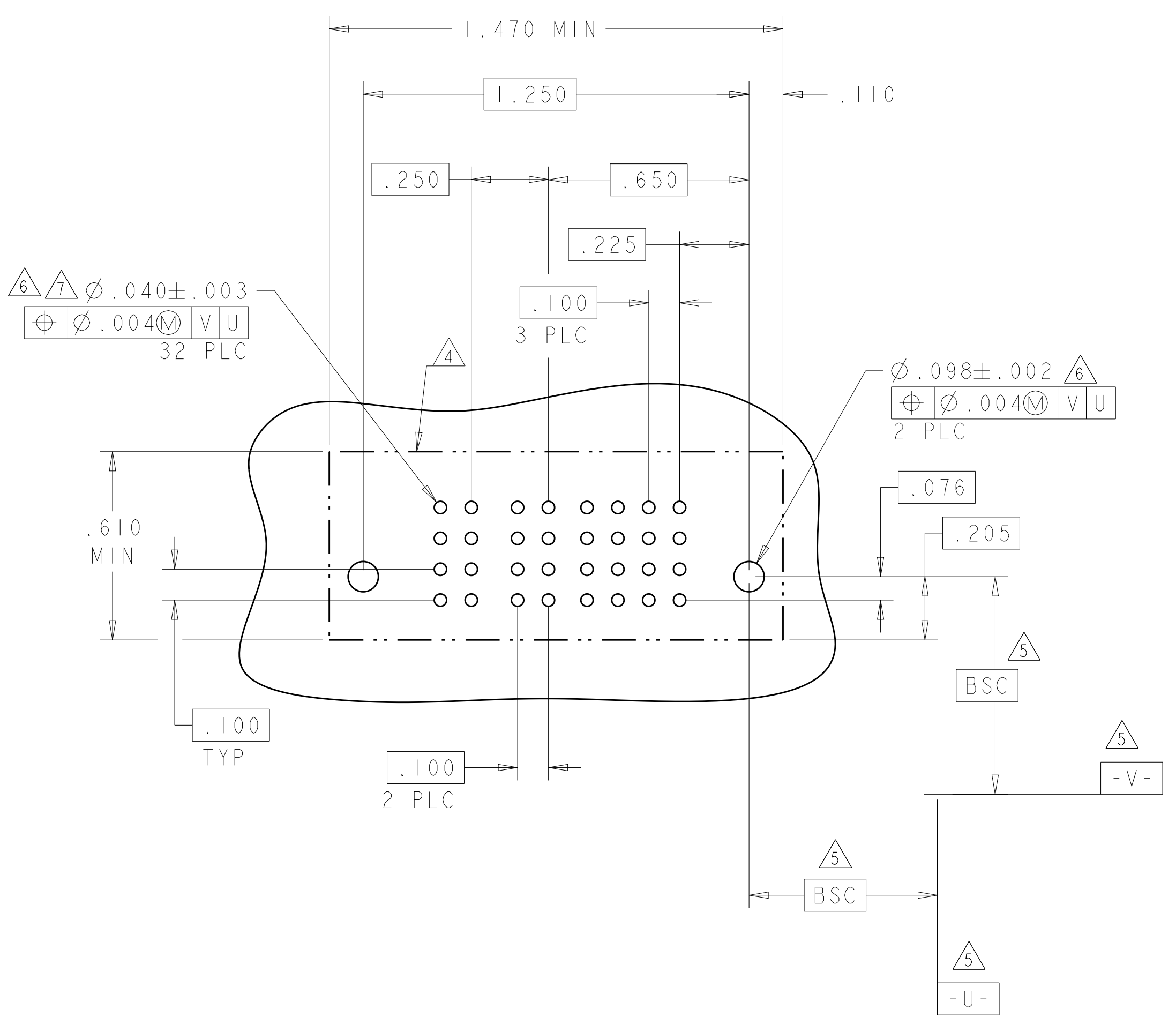

(F)

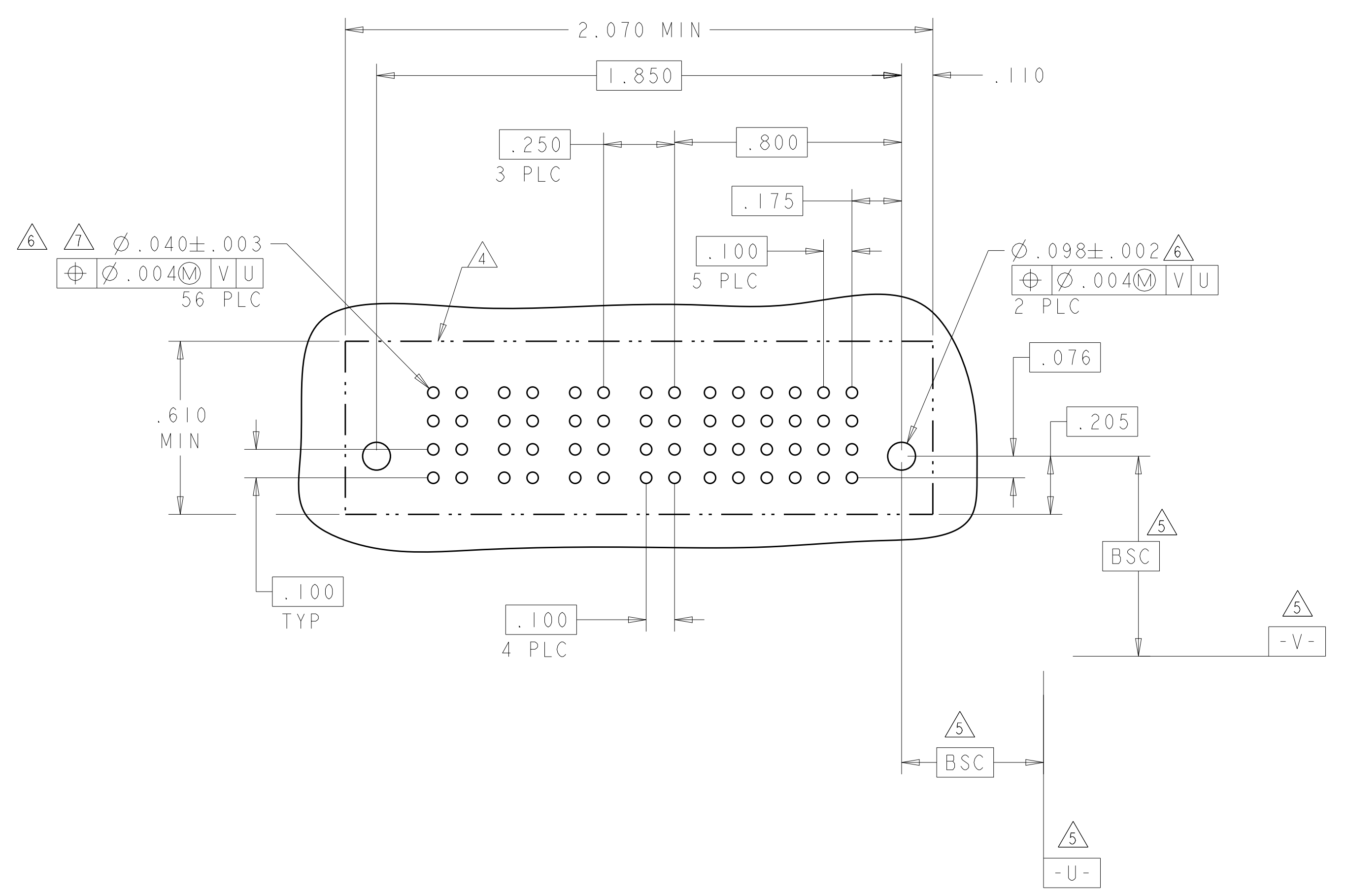

THIS DRAWING IS A CONTROLLED DOCUMENT.		DWN: C.ZHOU CHK: S.ZHAO	808082008	<b>STE</b> TE Connectivity
DIMENSIONS: INCHES		TOLERANCES UNLESS OTHERWISE SPECIFIED:		
		0 PLC ±	1 PLC ±	NAME: VERVIEWBAREBERSSEMBASSEMBLY W WITH IS FOR TO LOUDEDSE, FFRESSS FFITT MULT I-HELEAM -HELEAM XLE SIZE: 114-13058 WEIGHT: A100779C=6450861 CUSTOMER DRAWING
MATERIAL: -		2 PLC ±.01	3 PLC ±.005	
FINISH: -		4 PLC ±.0020	ANGLES: ±2°	
SCALE: 4:1		SHEET 6 OF 11		
REV: 66		DATE: -		

LOC	DIST	REVISIONS			
P	LTN	DESCRIPTION	DATE	DMN	APVD
-	-	SEE SHEET 1	-	-	-

PART NUMBER	ROWS	POWER										SIGNAL			
		P10	P9	P8	P7	P6	P5	P4	P3	P2	P1	4	3	2	1
I-6450861-1	D C B A	GS	GS	GS	GS	GS	GS	GS	GS	GS	GS	AP	AP	AP	AP
		GS	GS	GS	GS	GS	GS	GS	GS	GS	GS	AP	AP	AP	AP
		GS	GS	GS	GS	GS	GS	GS	GS	GS	GS	AP	AP	AP	AP
		GS	GS	GS	GS	GS	GS	GS	GS	GS	GS	AP	AP	AP	AP
16S + 10P															

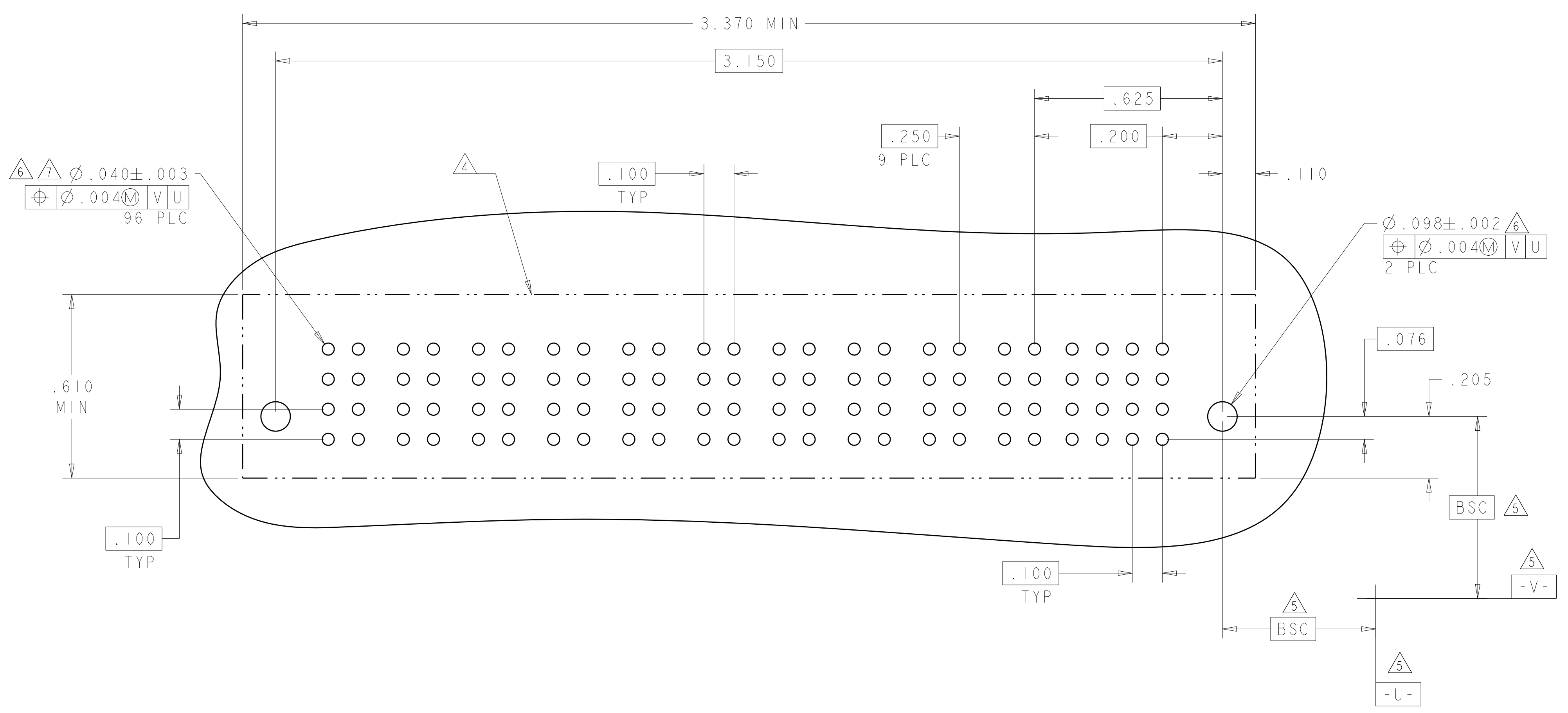

THIS DRAWING IS A CONTROLLED DOCUMENT.		DMN C. ZHOU	88MNR2008	 TE Connectivity
DIMENSIONS: INCHES		CHK S. ZHAO	88MNR2008	
TOLERANCES UNLESS OTHERWISE SPECIFIED:		APVD S. YAO	NAME	VERVIEW BARBERS CMB ASSEMBLY
0 PLC ±		PRODUCT SPEC	108-2292	W/TH HSK FOR TIG WELDING, PRESSURE FIT
1 PLC ±.01		APPLICATION SPEC	114-13058	MULTI-MATERIAL XLE
2 PLC ±.05		SIZE	A100779	C=6450861
3 PLC ±.0020		WEIGHT	-	-
4 PLC ±.0020		SCALE	4:1	SHEET 7 OF 11
ANGLES ±2°		FINISH	-	REV 66
MATERIAL		CUSTOMER DRAWING	SCALE	4:1

LOC		DIST		REVISIONS			
ES	00	P	LTN	DESCRIPTION	DATE	DMN	APVD
		-		SEE SHEET 1			

PART NUMBER	ROWS	POWER				SIGNAL								
		P4	P3	P2	P1	8	7	6	5	4	3	2	1	
1-6450861-2	D C B A	GP	GP	GP	GP	AP	AP	AP	AP	AP	AP	AP	AP	AP
		GP	GP	GP	GP	AP	AP	AP	AP	AP	AP	AP	AP	
		GP	GP	GP	GP	AP	AP	AP	AP	AP	AP	AP	AP	
		GP	GP	GP	GP	AP	AP	AP	AP	AP	AP	AP	AP	
32S + 4ACP														

PART NUMBER	ROWS	POWER												SIGNAL				
		P12	P11	P10	P9	P8	P7	P6	P5	P4	P3	P2	P1	4	3	2	1	
1-6450861-3	D C B A	GS	GS	GS	GS	GS	GS	GS	GS	GS	GS	GS	GS	GS	GS	GS	GS	GS
		GS	GS	GS	GS	GS	GS	GS	GS	GS	GS	GS	GS	GS	GS	GS	GS	GS
		GS	GS	GS	GS	GS	GS	GS	GS	GS	GS	GS	GS	GS	GS	GS	GS	GS
		GS	GS	GS	GS	GS	GS	GS	GS	GS	GS	GS	GS	GS	GS	GS	GS	GS
16S + 12P																		

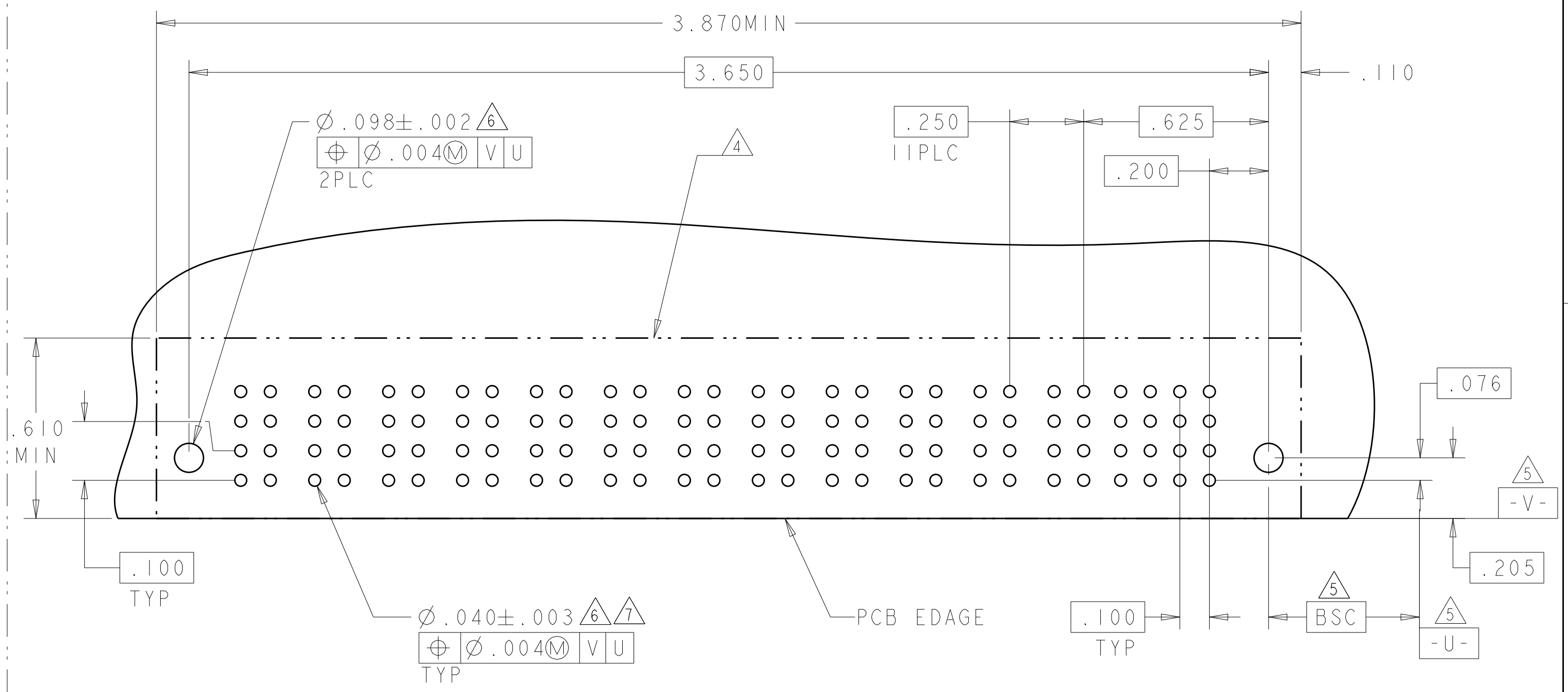
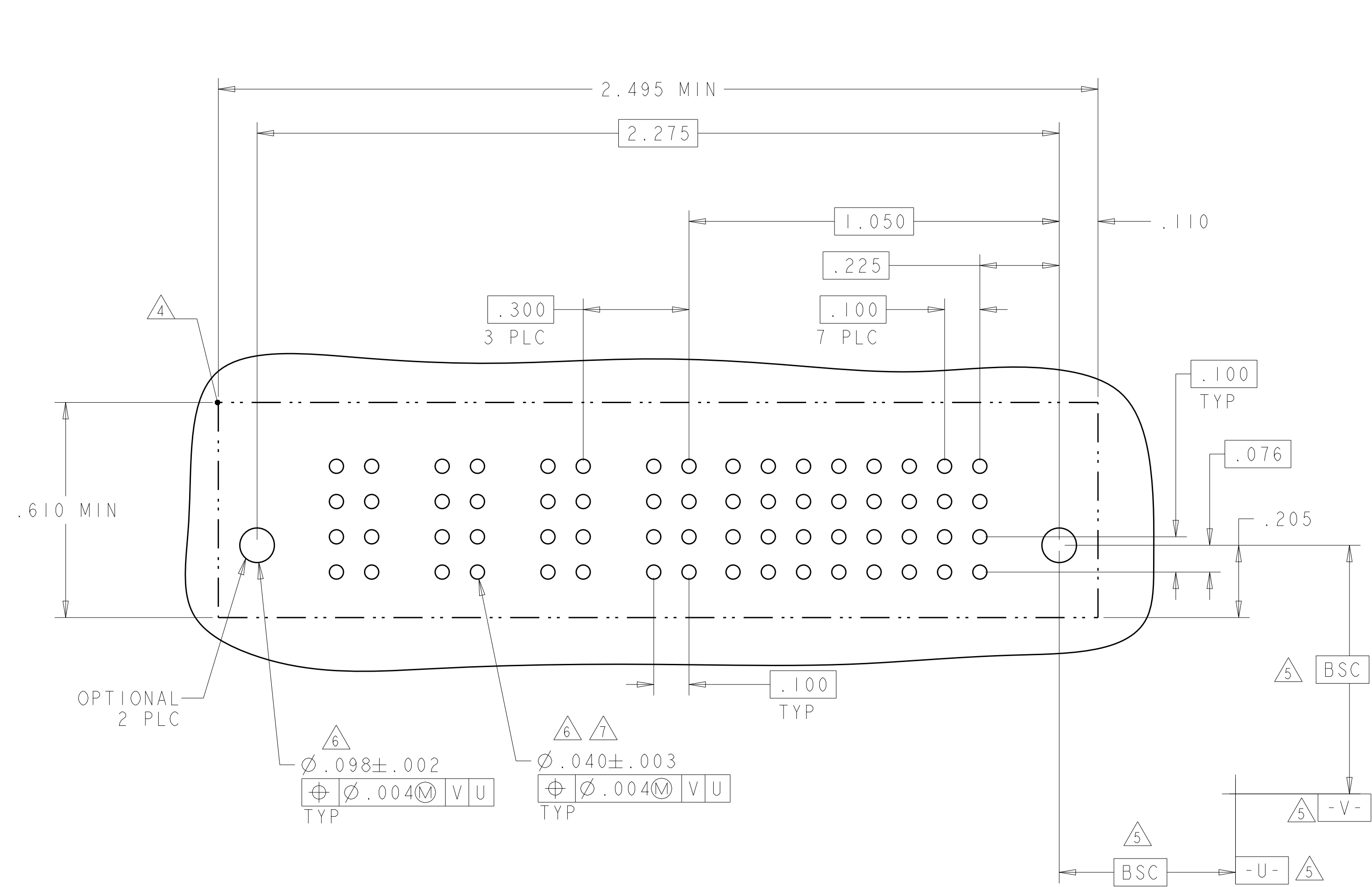

THIS DRAWING IS A CONTROLLED DOCUMENT.		DMN C. ZHOU 20JUN2012	NAME VERTICAL RECEPTACLE ASSEMBLY WITH SHORT GUIDE, PRESS FIT MULTI-BEAM XLE
DIMENSIONS: INCHES		CHK S. ZHAO 20JUN2012	PRODUCT SPEC 108-2292
TOLERANCES UNLESS OTHERWISE SPECIFIED:		APVD	APPLICATION SPEC 114-13251
0 PLC ± .005		SIZE A1	CAGE CODE 6450861
1 PLC ± .005		WEIGHT	RESTRICTED TO
2 PLC ± .005		Customer Drawing	SCALE 1:1 SHEET 8 OF 11 REV G5
3 PLC ± .005			
4 PLC ± .0020			
ANGLES ± .2°			
FINISH			



LOC		DIST		REVISIONS			
ES	00	P	LTN	DESCRIPTION	DATE	DWN	APVD
		-		SEE SHEET 1			

F6

PART NUMBER	ROWS	SIGNAL															
		16	15	14	13	12	11	10	9	8	7	6	5	4	3	2	1
1-6450861-4	D	BP	BP	BP	BP	BP	BP	BP	BP	BP	BP	BP	BP	BP	BP	BP	BP
	C	BP	BP	BP	BP	BP	BP	BP	BP	BP	BP	BP	BP	BP	BP	BP	BP
	B	BP	BP	BP	BP	BP	BP	BP	BP	BP	BP	BP	BP	BP	BP	BP	BP
	A	BP	BP	BP	BP	BP	BP	BP	BP	BP	BP	BP	BP	BP	BP	BP	BP
64S		HD															HD

PART NUMBER	ROWS	POWER				SIGNAL					
		P4	P3	P2	P1	6	5	4	3	2	1
1-6450861-5	D					AP	AP	AP	AP	AP	AP
	C					AP	AP	AP	AP	AP	AP
	B	GS	GS	GS	GS	AP	AP	AP	AP	AP	AP
	A	HD				AP	AP	AP	AP	AP	AP
24S + 4P											

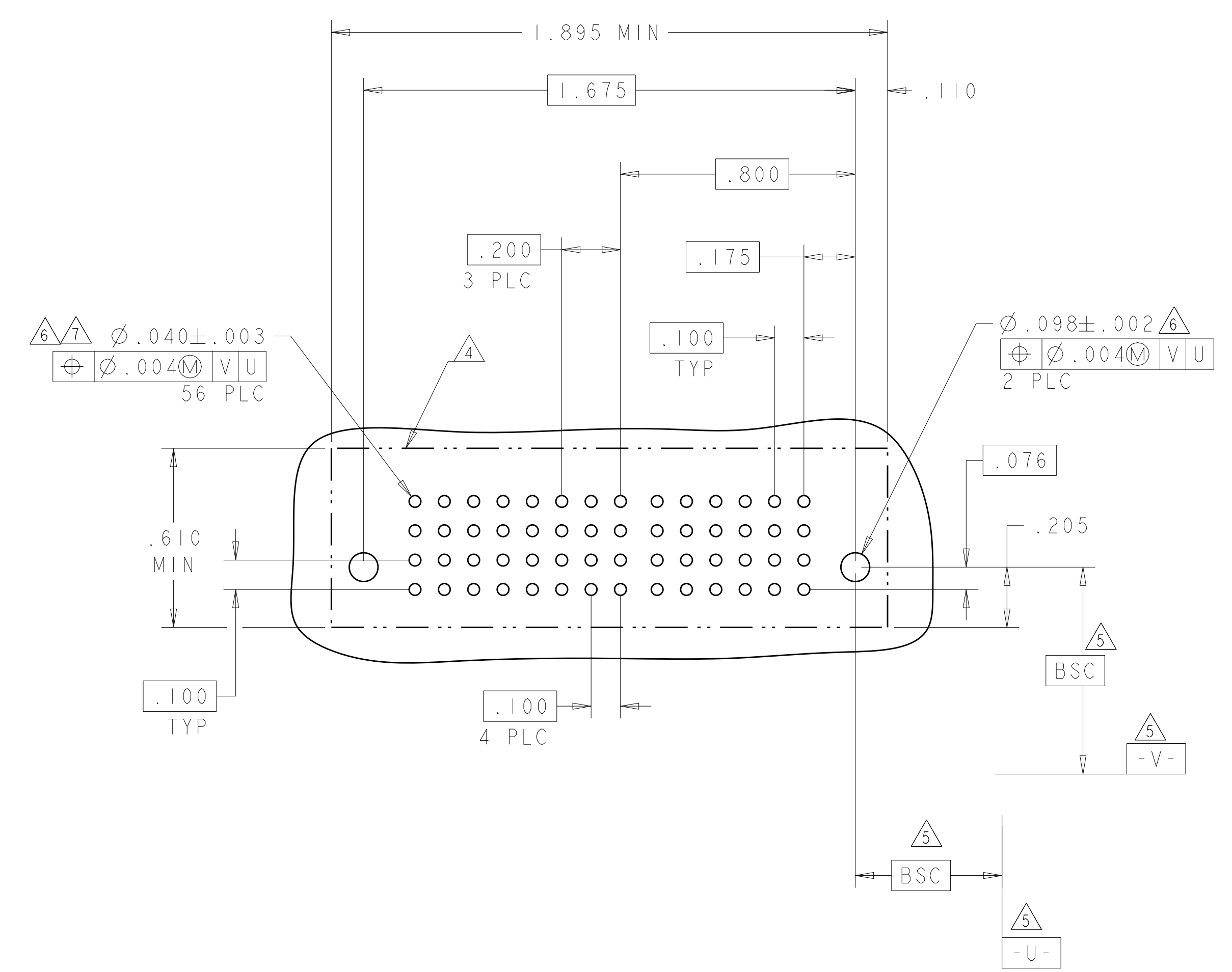
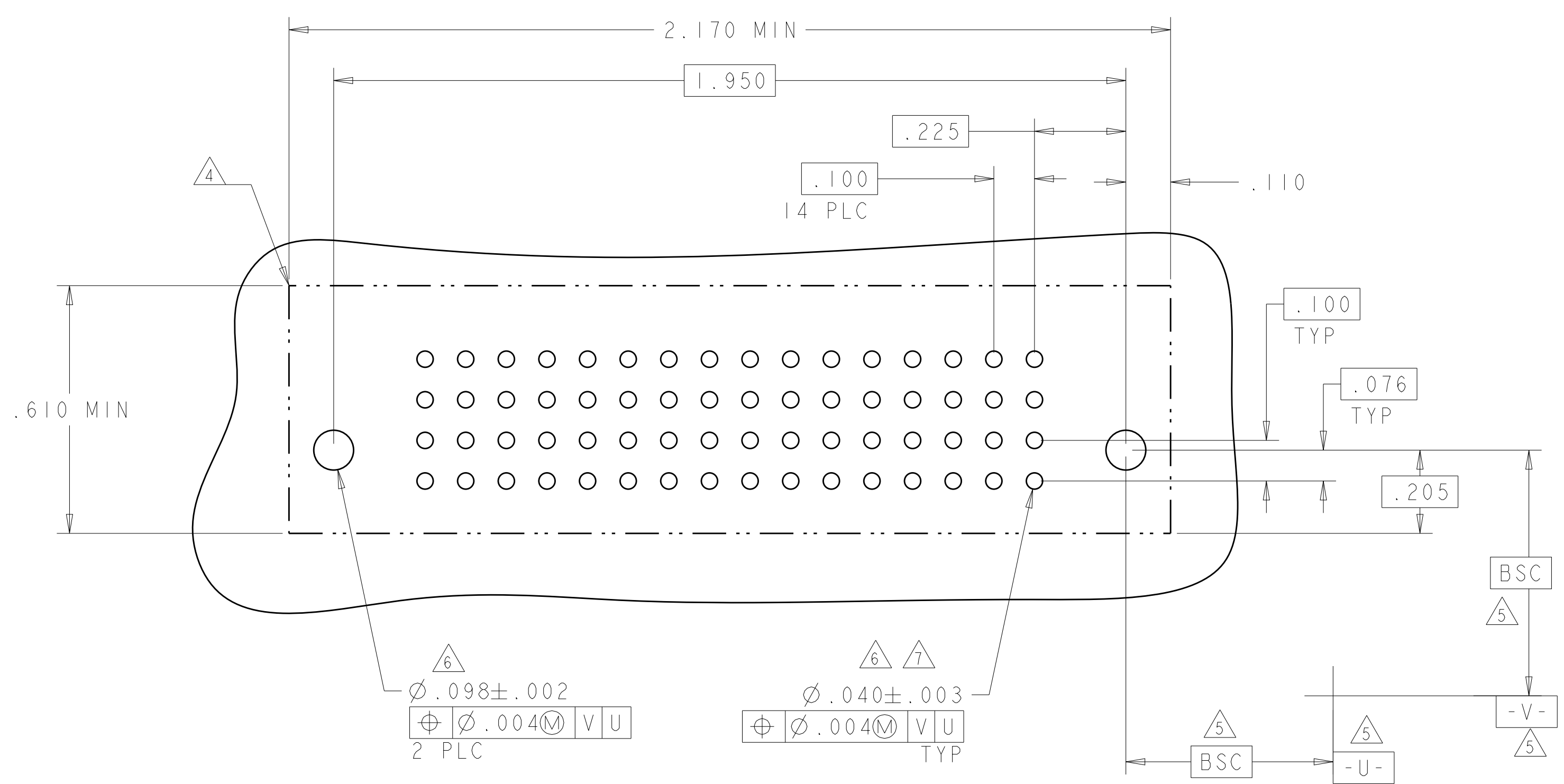

THIS DRAWING IS A CONTROLLED DOCUMENT.		DWN: C. ZHOU 20JUN2012	TE Connectivity
DIMENSIONS: INCHES		CHK: S. ZHAO 20JUN2012	
TOLERANCES UNLESS OTHERWISE SPECIFIED:		APVD: -	NAME: VERTICAL RECEPTACLE ASSEMBLY WITH SHORT GUIDE, PRESS FIT MULTI-BEAM XLE
0 PLC ± 1 PLC ± 2 PLC ± 3 PLC ±.005 4 PLC ±.0020 ANGLES ±.7° FINISH -		PRODUCT SPEC: 108-2292	RESTRICTED TO: -
MATERIAL: -		APPLICATION SPEC: 114-13251	SIZE: A1
		WEIGHT: -	CAGE CODE: 6450861
		Customer Drawing	SCALE: 1:1 SHEET 9 OF 11 REV: G5

LOC	DIST	REVISIONS			
P	LTN	DESCRIPTION	DATE	DMN	APVD
ES	00	SEE SHEET 1			

PART NUMBER	ROWS	SIGNAL			
		4	3	2	1
1-6450861-6	D	AP	AP	AP	AP
	C	AP	AP	AP	AP
	B	AP	AP	AP	AP
	A	AP	AP	AP	AP

16S

PART NUMBER	ROWS	POWER					SIGNAL			
		P4	P3	-	P2	P1	4	3	2	1
1-6450861-7	D	VS	VS	-	VS	VS	P	P	P	P
	C	VS	VS	-	VS	VS	P	P	P	P
	B	VS	VS	-	VS	VS	P	P	P	P

16S + 4P

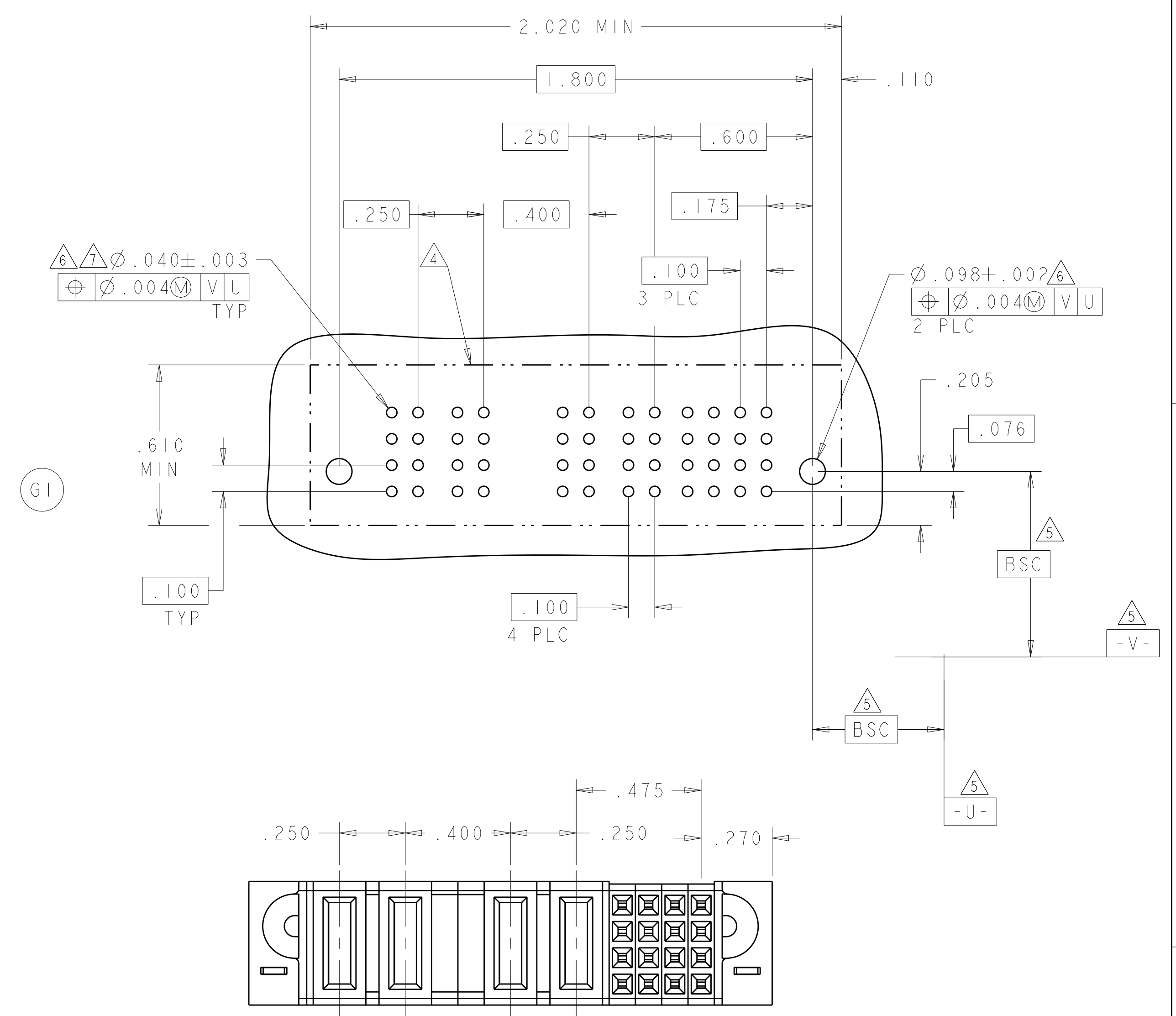
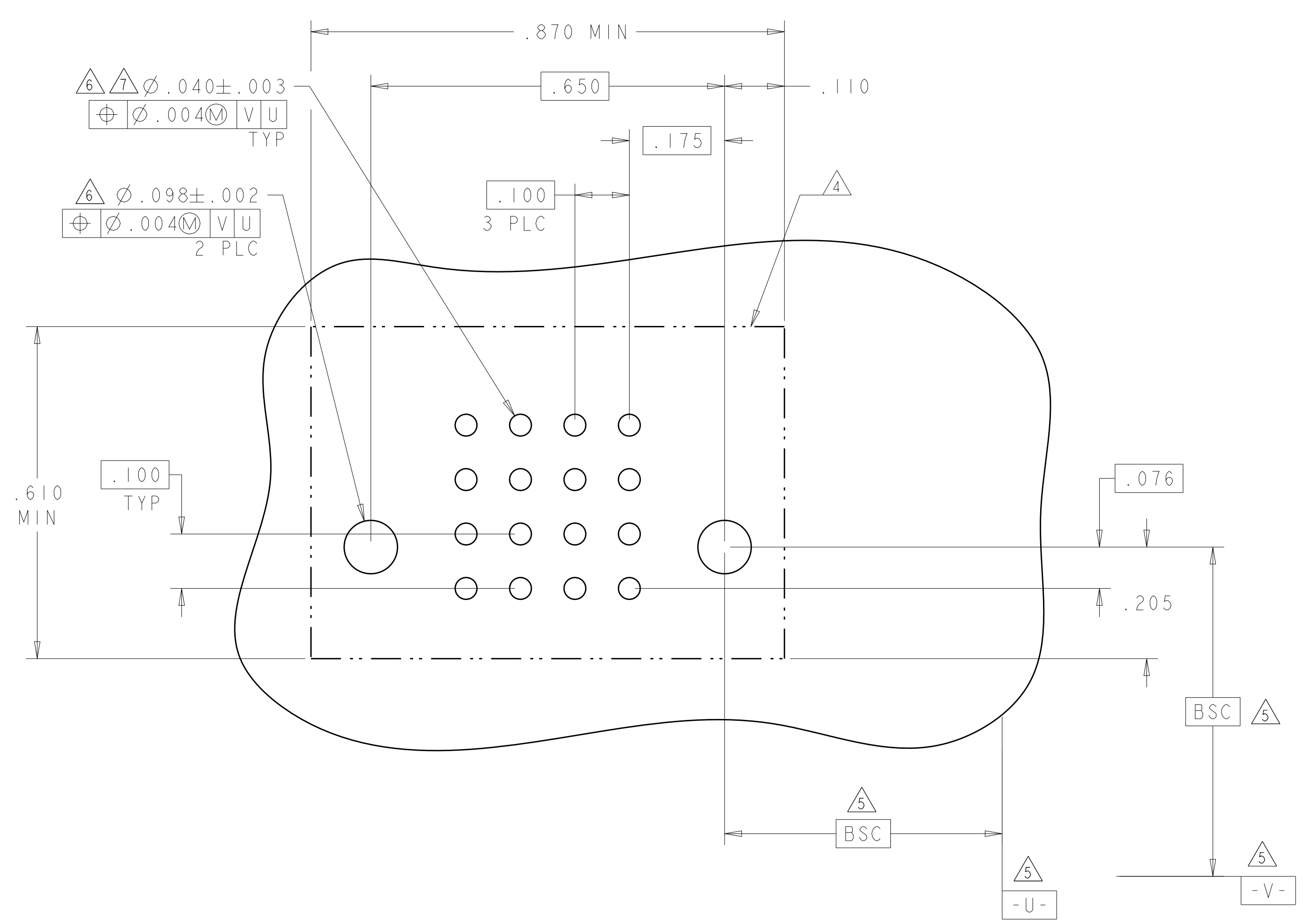

NO CONTACT LOADED

HD	HOLD DOWN
P	SIGNAL PRESS FIT CONTACT .115"
VS	STD POWER PRESS FIT CONTACT .115"
CODE	TAIL LENGTH

CONTACT TABLE

THIS DRAWING IS A CONTROLLED DOCUMENT. DWN: C. ZHOU 20JUN2012  
 CHK: S. ZHAO 20JUN2012

DIMENSIONS: INCHES	TOLERANCES UNLESS OTHERWISE SPECIFIED:	PRODUCT SPEC	NAME
0 PLC ± .005	1 PLC ± .005	108-2292	VERTICAL RECEPTACLE ASSEMBLY WITH SHORT GUIDE, PRESS FIT MULTI-BEAM XLE
2 PLC ± .005	3 PLC ± .005	APPLICATION SPEC	SIZE
4 PLC ± .0020	ANGLES ± .0020	114-13251	CAGE CODE DRAWING NO
MATERIAL	FINISH	WEIGHT	RESTRICTED TO
			A100779C=6450861

Customer Drawing SCALE 1:1 SHEET 10 OF 11 REV G5



## X-ON Electronics

Largest Supplier of Electrical and Electronic Components

*Click to view similar products for te connectivity manufacturer:*

Other Similar products are found below :

[570416-000](#) [CLTEQ-M81CE-SSRELAY-4-20V](#) [D38999/24FJ4AN](#) [358838-000](#) [4-1195131-0](#) [650069-000](#) [SMD100-2](#) [CB-1022B-78](#)  
[RM707012](#) [RP410012](#) [MMS42](#) [1-640426-8](#) [2EDL4CM](#) [DTS20W19-11PD-3028-LC](#) [RM202615](#) [NC6-P104-06](#) [MSPS103B](#) [DTS26F21-41AE](#) [DTS26F21-41PE-LC](#) [DTS26F21-11SE-3028-LC](#) [1932144-1](#) [293545-4](#) [LVR125S](#) [MS27466T25F4PB](#) [CKB-38-78010](#)  
[1206SFF150F/63-2](#) [D38999/20JB35HA](#) [D38999/24WJ20PA](#) [1754138-1](#) [TE1500A2R2J](#) [DTS24F25-29PC-3028-LC](#) [D38999/24WG11HA](#)  
[D38999/24WG11HN](#) [MS27467T21F11H](#) [DJT16E21-11HA](#) [1206SFH150F/24-2](#) [DTS24F19-11SC-3028-LC](#) [DTS24F21-41HN-LC](#)  
[DTS24F21-41AN](#) [DTS24F21-41PN-LC](#) [RP330024](#) [MS27467T21F35J](#) [MS27467T21F11J](#) [MS27467T21F16H-LC](#) [MS27467T21F35H](#)  
[MS27467T21F41H-LC](#) [DJT16E21-11PA-LC](#) [DJT16E21-11HA-LC](#) [DJT16E21-11AA](#) [MS27467T21B11JA](#)