

Single Phase Power Line Filter for Frequency Converters

# FC Series



UL Recognized



## FC Series

- Designed for frequency inverters and variable speed motor drives
- Suitable for electronically noisy environments
- Protects programmable logic controllers from RF noise on the AC power line
- Side flanges for easy mounting
- Touch safe terminals provide easy connections and prevent inadvertent contact for safety in the most demanding applications

## Ordering Information

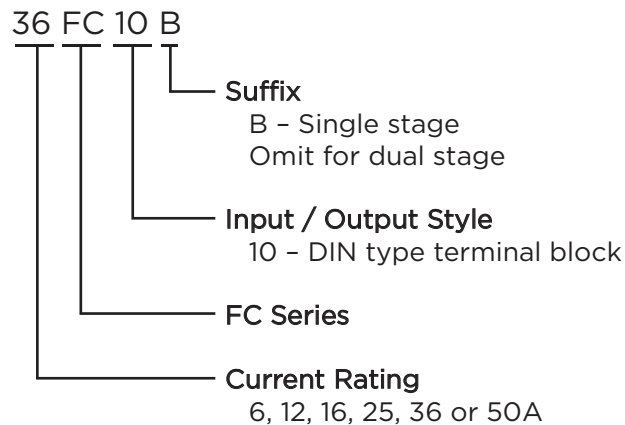

## Available Part Numbers

6FC10	
12FC10	12FC10B
16FC10	16FC10B
25FC10	25FC10B
36FC10	36FC10B
50FC10	50FC10B

## Specifications

### Maximum leakage current each Line to Ground:

	B suffix	no suffix
@ 120 VAC 60 Hz:	3.9 mA	3.8 mA
@ 250 VAC 50 Hz:	7.0 mA	6.7 mA

### Hipot rating (one minute):

Line to Ground:	2250 VDC
Line to Line:	1450 VDC

### Rated Voltage (max):

250 VAC

### Operating Frequency:

50/60 Hz

### Rated Current:

6 to 50A

### Operating Ambient Temperature Range

(at rated current  $I_r$ ): -10°C to +40°C  
In an ambient temperature ( $T_a$ ) higher than +40°C the maximum operating current ( $I_o$ ) is calculated as follows:  $I_o = I_r \sqrt{(85-T_a)/45}$

## Electrical Schematics

### FC10

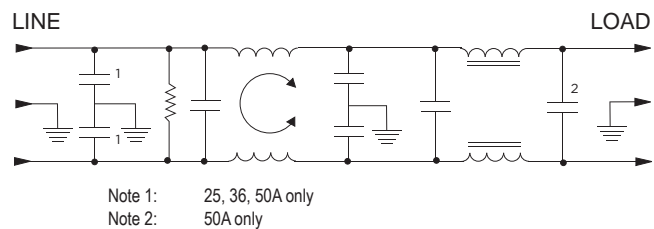

### FC10B

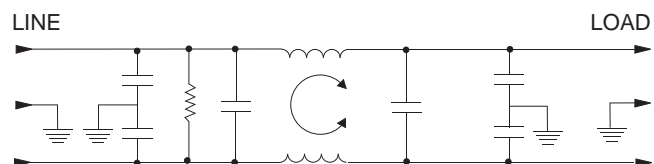

Single Phase Filter for Frequency Converters *(continued)*

# FC Series

## Case Styles

### FC10 / FC10B (6, 12, 16A)

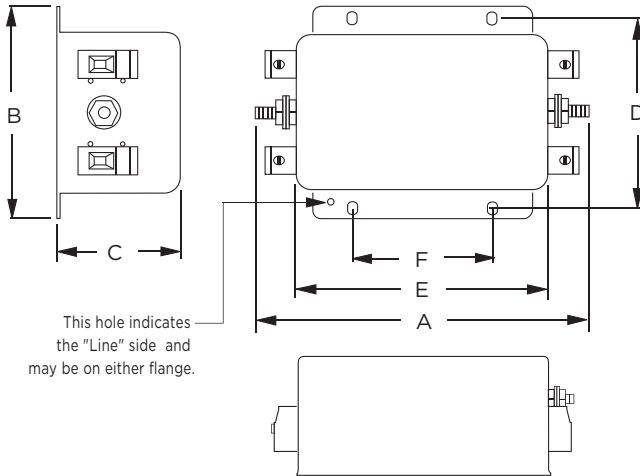

Typical Dimensions:

- Line/Load Terminals (4): DIN type accepts 10AWG solid / 12AWG stranded
- Ground Terminals (2): 8-32 screw terminals
- Mounting Holes (4): .203 x .156 [5.16 x 3.96]

### FC10 / FC10B (25, 36, 50A )

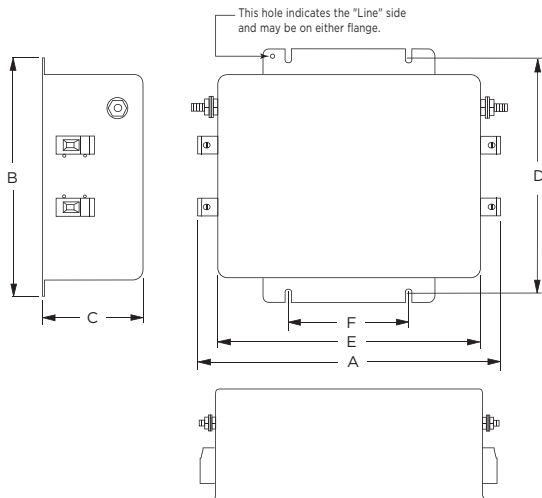

Typical Dimensions:

- Line/Load Terminals (4): DIN type accepts 8AWG solid / 10AWG stranded
- Ground Terminals (2): 8-32 screw terminals
- Mounting Slots (4): .260 [6.6] wide

## Case Dimensions

Part No.	A (max)	B (max)	C (max)	D $\pm .020$ $\pm .510$	E (max)	F $\pm .010$ $\pm .254$
6FC10	<b>4.60</b> <i>116.8</i>	<b>3.10</b> <i>78.7</i>	<b>1.78</b> <i>45.21</i>	<b>2.677</b> <i>67.8</i>	<b>3.70</b> <i>94.0</i>	<b>2.0</b> <i>50.8</i>
12FC10/10B	<b>5.47</b>	<b>3.96</b>	<b>2.18</b>	<b>3.50</b>	<b>4.53</b>	<b>2.0</b>
16FC10/10B	<i>139.0</i>	<i>100.6</i>	<i>55.4</i>	<i>88.9</i>	<i>114.8</i>	<i>5.08</i>
25, 36, 50	<b>6.90</b>	<b>5.48</b>	<b>2.55</b>	<b>4.90</b>	<b>5.94</b>	<b>2.756</b>
FC10/10B	<i>175.3</i>	<i>139.2</i>	<i>64.77</i>	<i>124.5</i>	<i>150.9</i>	<i>70.0</i>

1  
RFI Power Line Filters

Single Phase Filter for Frequency Converters *(continued)*

# FC Series

## Performance Data

### Typical Insertion Loss

Measured in closed 50 Ohm system

— Common Mode / Asymmetrical (L-G)  
— Differential Mode / Symmetrical (L-L)

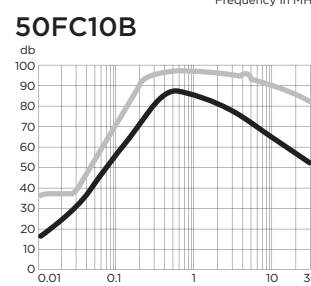
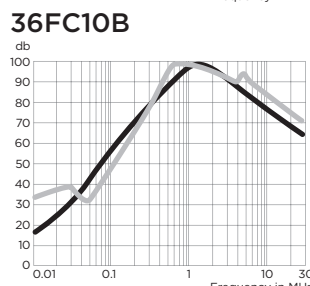
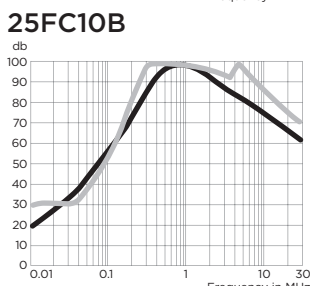
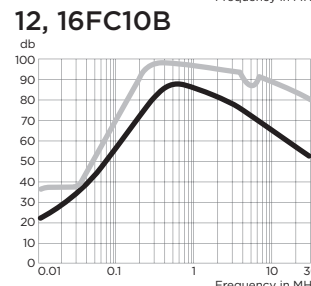
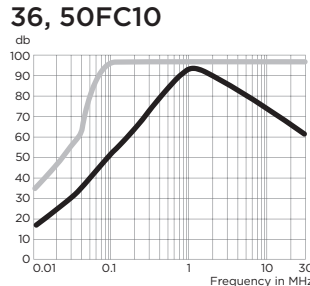
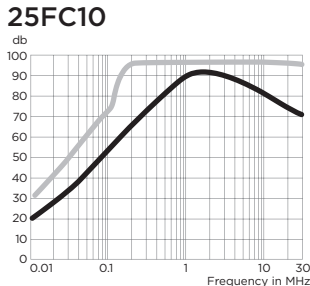
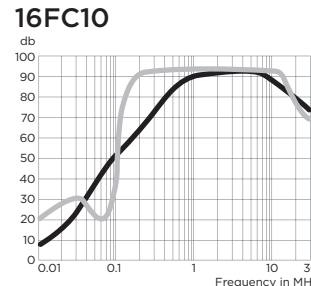
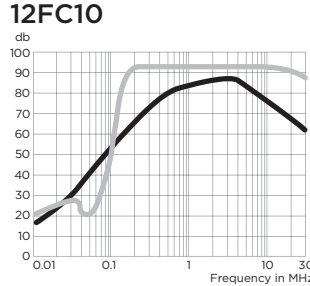
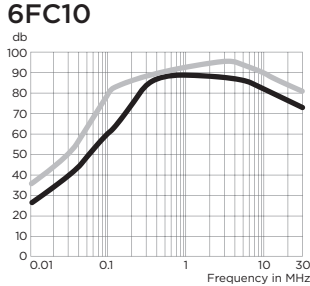

### Minimum Insertion Loss

Common Mode / Asymmetrical (Line to Ground)

Differential Mode / Symmetrical (Line to Line)

Part No.	Frequency – MHz								
	.01	.03	.05	.1	.5	1	5	10	30
6FC10	9	19	26	37	65	65	50	40	35
12FC10	5	17	25	37	65	65	65	60	35
16FC10	4	15	22	36	65	65	70	70	35
25FC10	2	14	22	36	75	75	70	70	48
36, 50FC10	-	6	14	27	68	75	70	70	50
12, 16FC10B	16	28	37	50	81	76	63	55	38
25FC10B	14	25	36	49	91	88	71	64	46
36FC10B	11	25	37	50	81	87	73	66	49
50FC10B	11	24	36	49	81	75	62	54	37

Part No.	Frequency – MHz								
	.01	.03	.05	.1	.5	1	5	10	30
6FC10	10	10	35	60	75	75	60	50	45
12FC10	14	14	30	51	75	75	75	70	45
16FC10	14	14	29	55	75	75	75	70	45
25FC10	14	14	17	42	75	75	70	70	50
36, 50FC10	14	14	17	42	75	75	70	70	50
12, 16FC10B	30	32	46	64	91	86	77	78	65
25FC10B	24	24	31	46	92	87	86	75	55
36FC10B	27	33	27	41	89	88	82	74	55
50FC10B	30	32	48	64	91	87	82	79	67

## X-ON Electronics

Largest Supplier of Electrical and Electronic Components

*Click to view similar products for [Power Line Filters](#) category:*

*Click to view products by [TE Connectivity](#) manufacturer:*

Other Similar products are found below :

[6609019-3](#) [6609026-5](#) [6609030-6](#) [6609973-2](#) [D30A](#) [7-1609090-5](#) [F2810](#) [F4456A](#) [F7382Z](#) [F7863Z](#) [FAHAV3100ZC000](#) [806276](#) [FN2020B-1-06](#) [FN2080B-10-06](#) [FN2410H-32-33](#) [FP144](#) [FS4153-20-06](#) [FS4353-500-99](#) [12-MMB-030-11-D](#) [DB4-393](#) [15811T200](#) [20B1](#) [LC630](#) [2B1](#) [1609080-2](#) [1609993-8](#) [1-6609070-1](#) [F1100AA02](#) [F1150CC10](#) [F1500CA10](#) [F1500CA15](#) [F4041Z](#) [F7585E](#) [1B1](#) [FN2070A-16-06](#) [FN2090A-20-06](#) [FN2090B-12-06](#) [FN2090Z-1-06](#) [FN2410H-25-33](#) [FN2410H-60-34](#) [FN2410H-8-44](#) [FN2412H-8-44](#) [FN323B-6-01](#) [FN3258H-130-35](#) [FN610R-3-06](#) [20EHQ7](#) [20EHZ7](#) [20K1](#) [30B6](#) [3K1](#)