

THIS DRAWING IS UNPUBLISHED. RELEASED FOR PUBLICATION
 © COPYRIGHT BY TYCO ELECTRONICS CORPORATION. ALL RIGHTS RESERVED.

| LOC | | DIST | | REVISIONS | | | |
|-----|-----|-------------|-----------------------|-----------|------|----|--|
| P | LTR | DESCRIPTION | DATE | DWN | APVD | | |
| GP | 00 | B | REV PER ECO-07-027901 | 27NOV07 | RG | PD | |

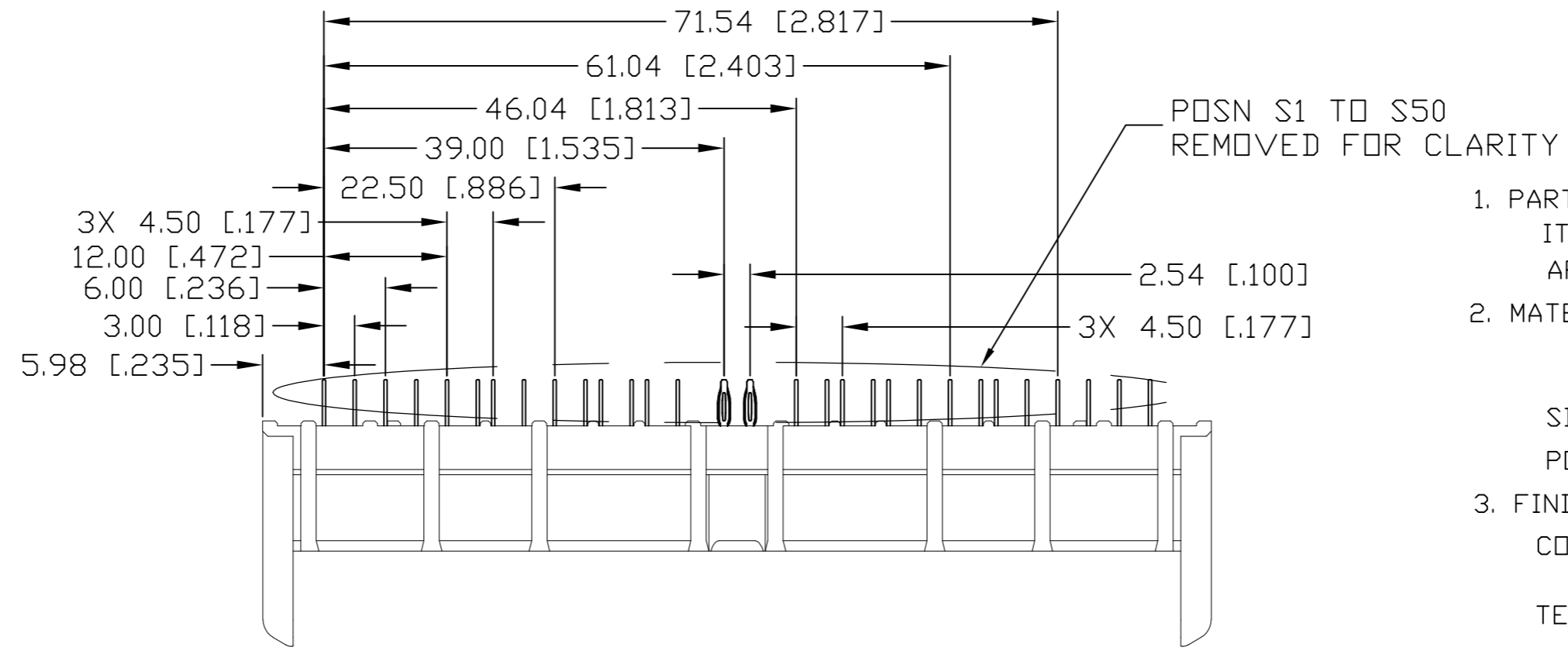

- PART NUMBER CHANGES AND OR DESIGN CHANGES AFFECTING ITEM INTERCHANGEABILITY REQUIRE PRIOR TYCO ELECTRONICS APPROVAL AND AUTHORIZATION BY REVISION TO THIS DRAWING.
- MATERIALS:
 INSULATORS: THERMOPLASTIC, GLASS REINFORCED, COLOR: BLACK, UL94V-0 FLAMMABILITY RATED.
 SIGNAL PINS: BRASS ALLOY.
 POWER CONTACTS: COPPER ALLOY.
- FINISHES:
 CONTACT PLATING: SELECTIVE GOLD 0.76µm MIN THK. OVER NICKEL 1.27µm MIN THK.
 TERMINAL PLATING:
 TIN PLATE 3.05µm MIN THK. OVER NICKEL 1.27µm MIN THK.
- ITEMS PROVIDED TO THIS SPECIFICATION TO BE PERMANENTLY IDENTIFIED PER THE FOLLOWING IDENTIFIER.
 YEAR WEEK
 DATE CODE (e.g. 0206) XXXX

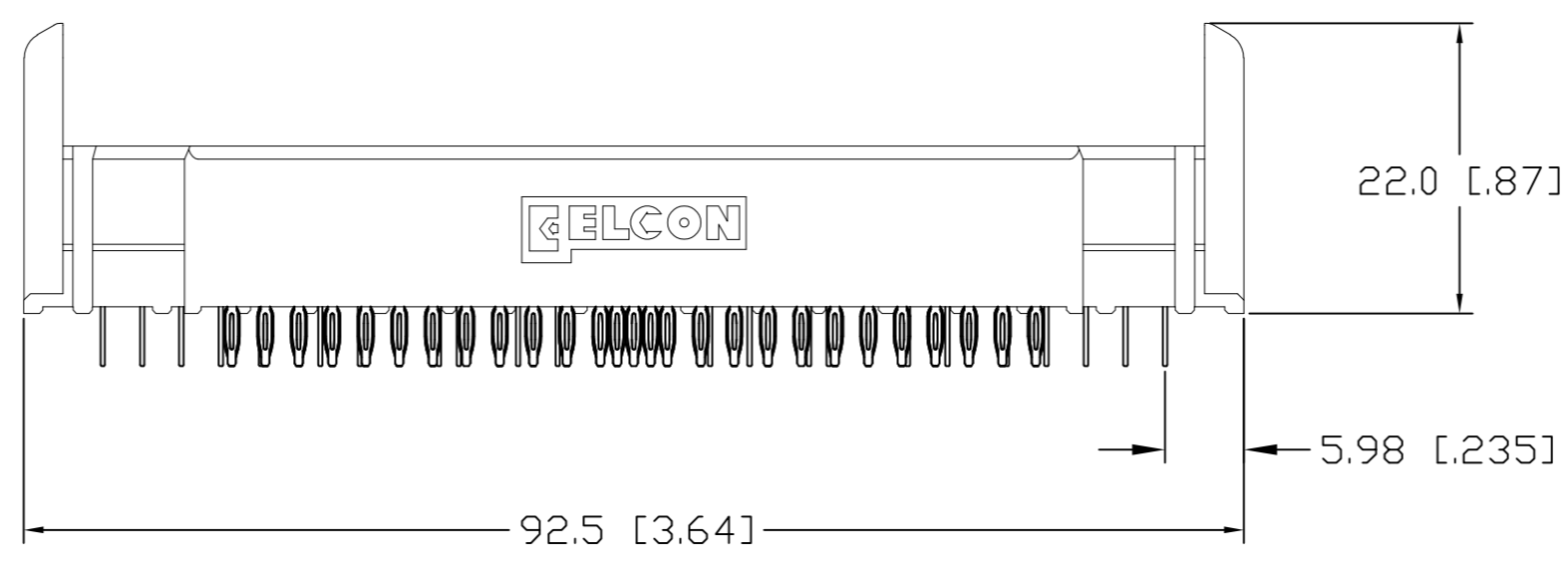
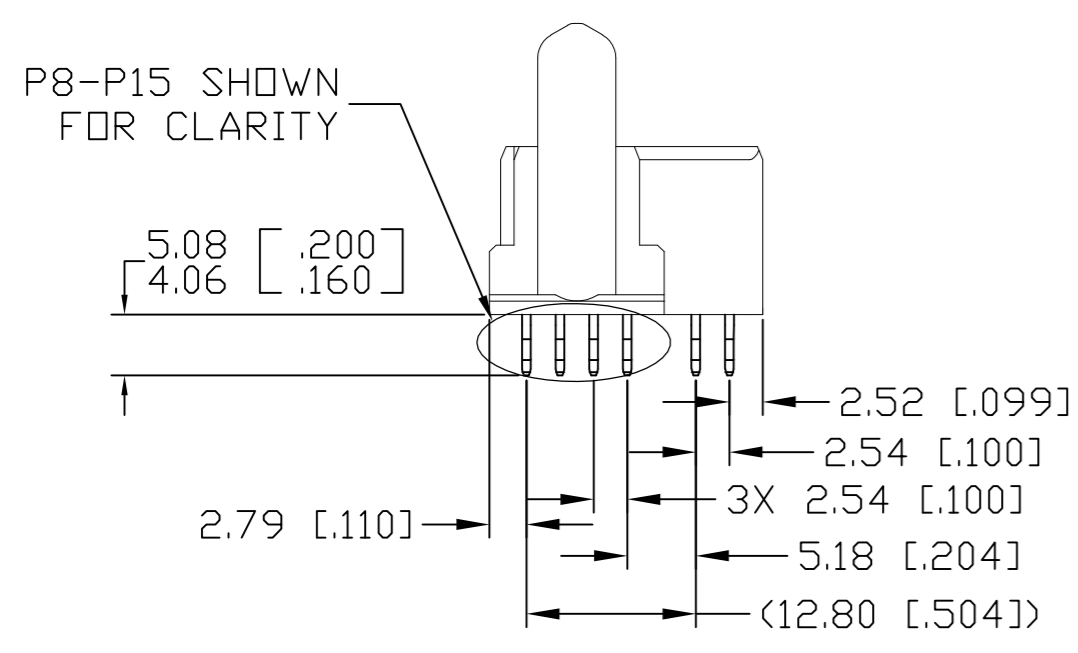
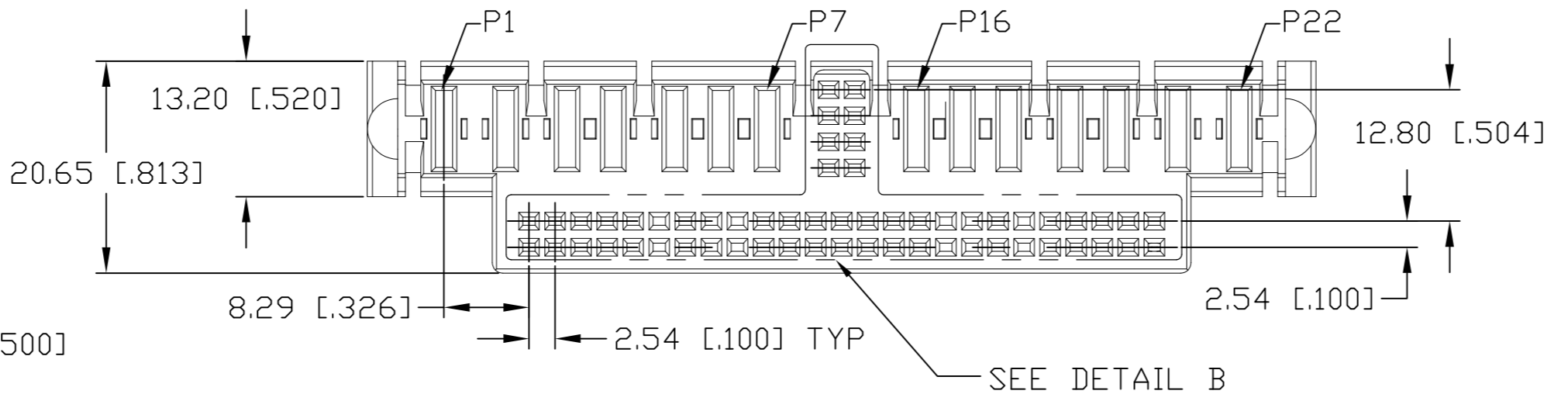
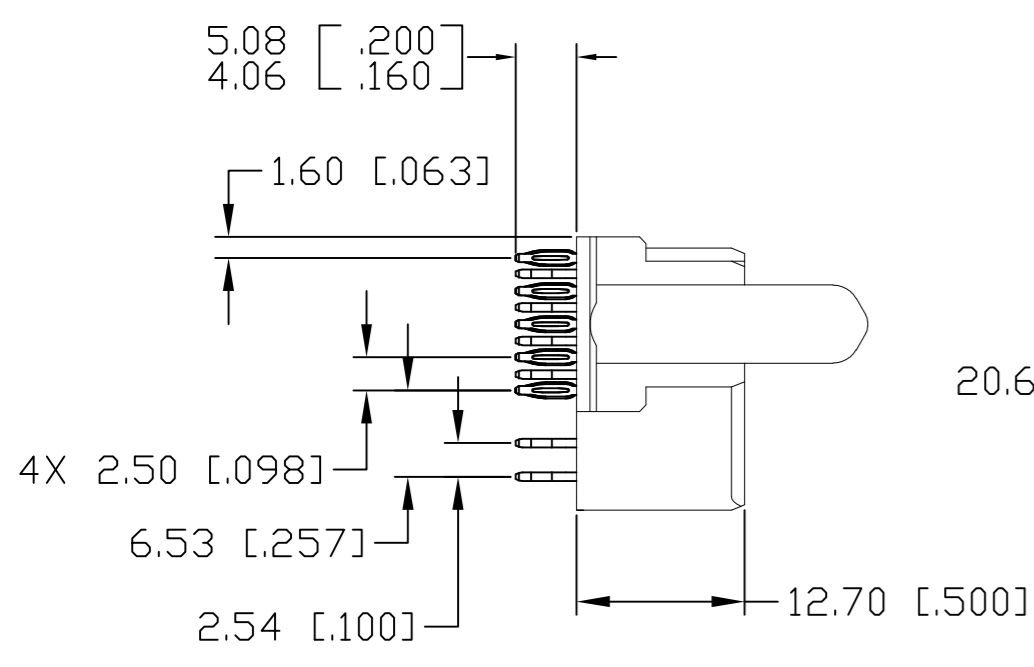

| | |
|-------------|-----------|
| AS SHOWN | 6651743-1 |
| DESCRIPTION | PART NO. |

| | | | | |
|--|--|------------------------------------|--|--------------------|
| THIS DRAWING IS A CONTROLLED DOCUMENT. | | DWN R.GRZYBOWSKI 27NOV2007 | Tyco Electronics Corporation Harrisburg, PA 17105-3608 | |
| DIMENSIONS: mm | | CHK P.DAMATO 27NOV07 | NAME SOCKET CONNECTOR, STRAIGHT COMPLIANT TAILS CUSTOM, MINIPAK | |
| TOLERANCES UNLESS OTHERWISE SPECIFIED: 0 PLC ± - 1 PLC ± .3 2 PLC ± .15 3 PLC ± - 4 PLC ± - ANGLES ± 3 | | APVD CHAU/FLICKINGER 27NOV07 | PRODUCT SPEC | |
| MATERIAL | | APPLICATION SPEC | SIZE A2 | CAGE CODE 00779 |
| FINISH | | WEIGHT | DRAWING NO 6651743 | RESTRICTED TO |
| | | CUSTOMER DRAWING | SCALE 1:1 | SHEET 1 of 2 |
| | | | REV B | |

6651743

THIS DRAWING IS UNPUBLISHED. RELEASED FOR PUBLICATION
 © COPYRIGHT BY TYCO ELECTRONICS CORPORATION. ALL RIGHTS RESERVED.

| LOC | DIST | REVISIONS | | | |
|-----|------|-------------|------|-----|------|
| P | LTR | DESCRIPTION | DATE | DWN | APVD |
| GP | 00 | SEE SHEET 1 | - | - | - |

DETAIL A

RECOMMENDED PRINTED CIRCUIT HOLE
 FINISHED HOLE: $\phi 1.02$ [0.040] ± 0.08 [0.003]
 DRILLED HOLE: $\phi 1.15$ [0.0453] ± 0.013 [0.0005]
 COPPER PLATE: .025 [0.0010] MINIMUM (PER SURFACE)
 TIN PLATE: .008 [0.0003] MINIMUM (PER SURFACE)

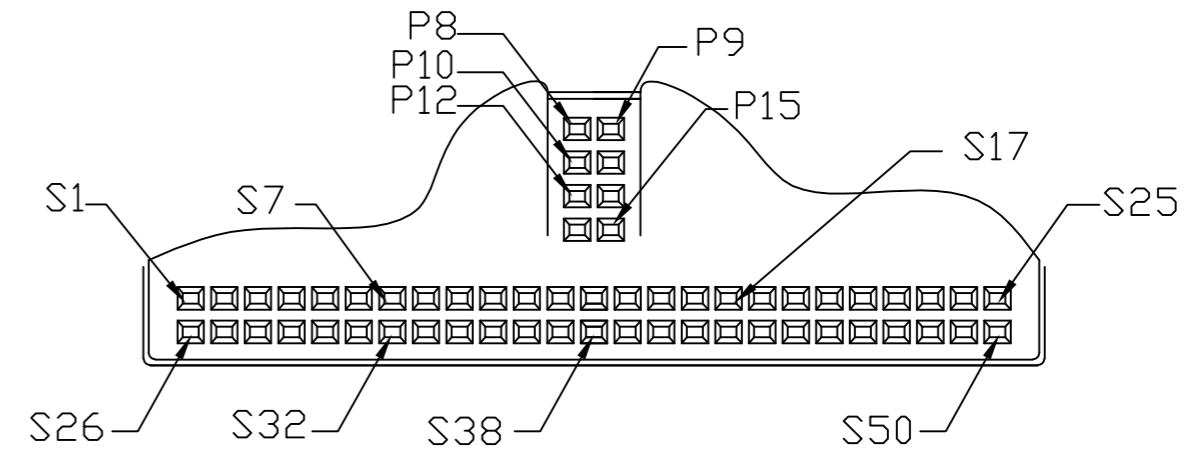

DETAIL B

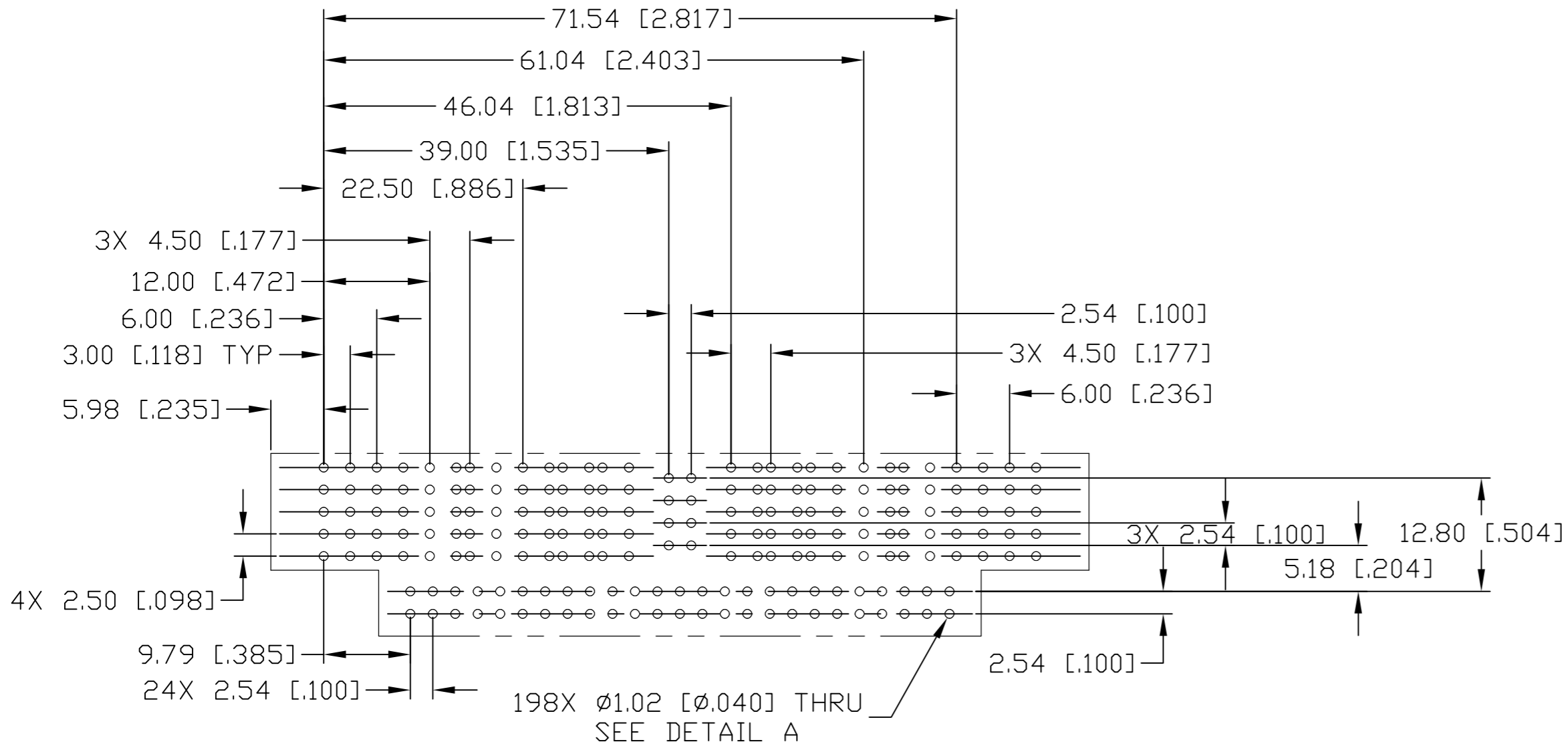

PRINTED CIRCUIT LAYOUT

| CONNECTOR | CONTACT | POSITION | CONTACT PITCH | VOLTAGE RATING* |
|-----------|---------|----------------------------------|---------------|-----------------|
| SOCKET | SIGNAL | S1-S50 P8-P14 | 2.54 [0.100] | 60 VOLTS |
| | POWER | P3-P4, P5-P7 P16-P18, P19-P21 | 4.50 [0.177] | COMMON |
| | POWER | P1-P2, P21-P22 | 6.00 [0.236] | 60 VOLTS |

| | | | | |
|--|-------------|------------------------------------|--|-----------------------|
| THIS DRAWING IS A CONTROLLED DOCUMENT. | | DWN R.GRZYBOWSKI 27NOV2007 | Tyco Electronics Corporation Harrisburg, PA 17105-3608 | |
| DIMENSIONS: mm | | CHK P.DAMATO 27NOV07 | NAME SOCKET CONNECTOR, STRAIGHT COMPLIANT TAILS CUSTOM, MINIPAK | |
| TOLERANCES UNLESS OTHERWISE SPECIFIED: 0 PLC ± - 1 PLC ± .3 2 PLC ± .15 3 PLC ± - 4 PLC ± - ANGLES ± 3 | | APVD CHAU/FLICKINGER 27NOV07 | PRODUCT SPEC - | APPLICATION SPEC - |
| MATERIAL - | FINISH - | WEIGHT - | SIZE A2 | CAGE CODE 00779 |
| CUSTOMER DRAWING | | | SCALE 1:1 | SHEET 2 OF 2 |
| | | | | REV B |

X-ON Electronics

Largest Supplier of Electrical and Electronic Components

Click to view similar products for [Power to the Board](#) category:

Click to view products by [TE Connectivity](#) manufacturer:

Other Similar products are found below :

[6450171-4](#) [6450552-7](#) [6600323-8](#) [6643429-1](#) [6646040-2](#) [6651939-1](#) [6766604-1](#) [120959-1](#) [1393557-2](#) [1393532-2](#) [1393532-3](#) [1393532-4](#)
[1393557-1](#) [1600812-5](#) [1-6450861-2](#) [1744132-7](#) [1761122-1](#) [1766250-1](#) [1892109-1](#) [2-6450860-5](#) [2-6450870-0](#) [1-6450161-4](#) [1-6450850-6](#) [1-6450869-6](#) [1645526-2](#) [1-6600130-0](#) [2005243-2](#) [377-0020-11130](#) [TE34-12-16P-F0](#) [5-6450830-6](#) [5646956-4](#) [377-0080-11131A](#) [4-6450830-9](#)
[4-6600333-3](#) [10125416-4050LF](#) [6600320-3](#) [3-6450860-5](#) [1888123-2](#) [6450166-1](#) [6643978-1](#) [6766605-1](#) [701-15-02109](#) [N11444](#) [6651938-1](#)
[6450810-7](#) [46437-1112](#) [1-1589677-8](#) [5646956-5](#) [6450813-2](#) [6450129-4](#)