

THIS DRAWING IS UNPUBLISHED. RELEASED FOR PUBLICATION
 © COPYRIGHT - By - ALL RIGHTS RESERVED.

LOC		DIST		REVISIONS			
P	LTR	DESCRIPTION	DATE	DWN	APVD		
	A3	REVISED PER ECO-11-004917	11MAR11	RK	HMR		

NOTES:

MATERIAL:

HOUSING: THERMOPLASTIC, UL94V-0 BLACK.
 TERMINALS: COPPER ALLOY, BRIGHT TIN PLATED.
 SCREWS: 6-32, STEEL, ZINC PLATED WITH CLEAR CHROMATE.
 UNLESS OTHERWISE NOTED.

ELECTRICAL:

MAXIMUM CURRENT: 25A.
 OPERATING VOLTAGE: 300V.
 WIRE RANGE: 12-22 AWG.
 RECOMMENDED TIGHTENING TORQUE: 7 IN-LBS.

ENVIRONMENT:

OPERATING TEMP.: +105°C

- 1 MARKED WITH WHITE PERMANENT INK.
- 2 SCREWS ARE NICKEL PLATED BRASS.
- 3 OBSOLETE PARTS: OBSOLETE CIS STREAMLINING PER D.RENAUD/D.SINISI

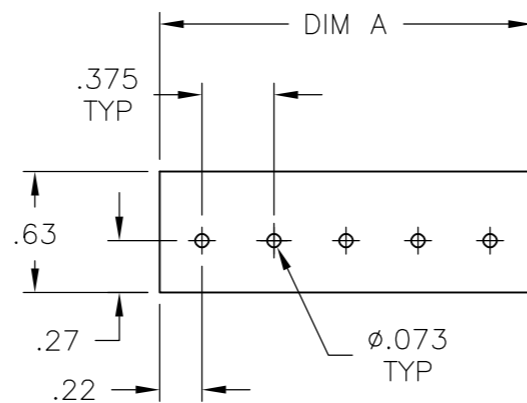
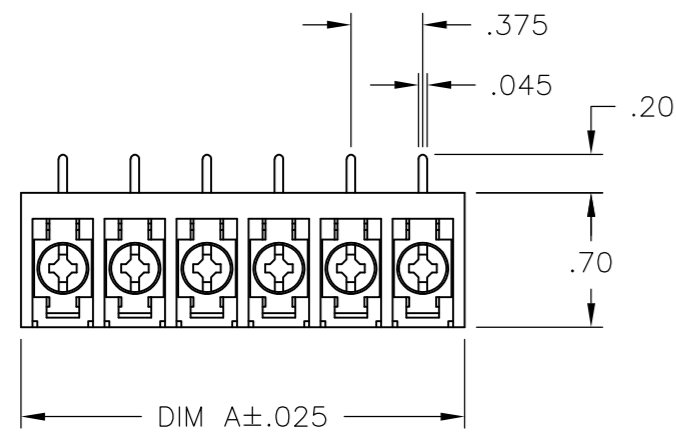

RECOMMENDED PCB LAYOUT

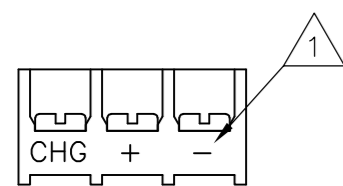
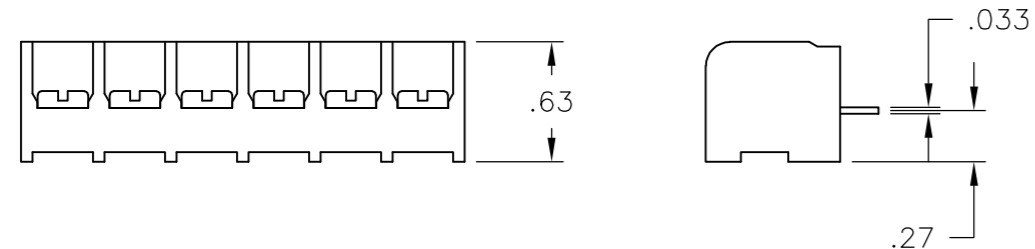

7-1437651-0

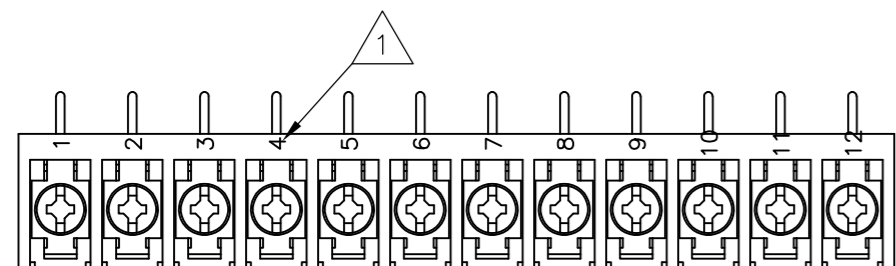

2-796988-3 OBSOLETE

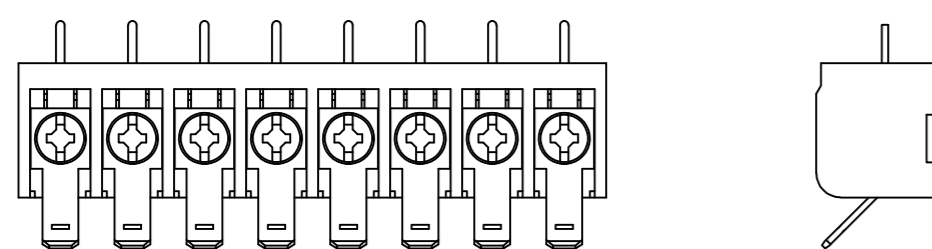

796905-1

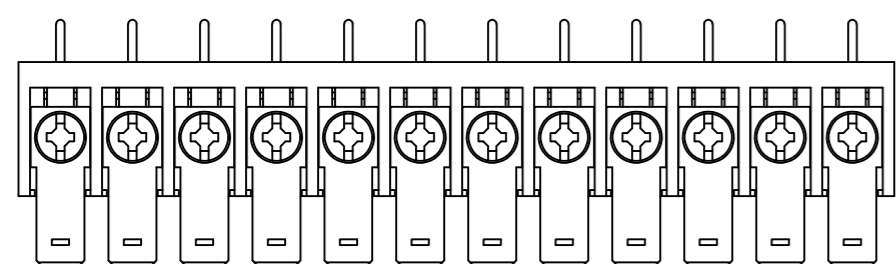

2-796988-9 OBSOLETE

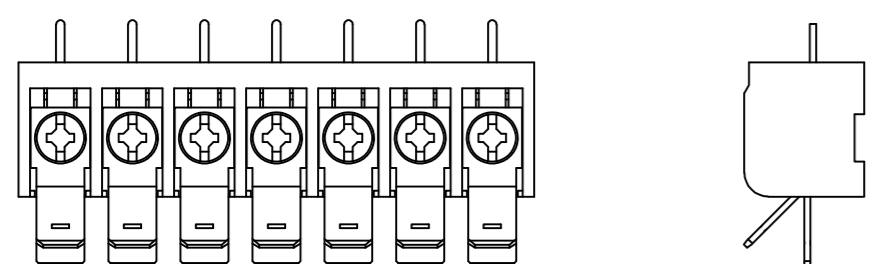

9-1437651-3

DIM. "A"	NO. OF POS.	CATALOG NUMBER	PART NO.
11.311	30	6PCR-30-007	796905-3
10.936	29	6PCR-29-007	796905-2
10.561	28	6PCR-28-007	4-1546158-2
10.186	27	6PCR-27-007	3-1546399-2
9.811	26	6PCR-26-007	3-1546399-1
9.436	25	6PCR-25-007	3-1546399-0
9.061	24	6PCR-24-007	2-1546399-9
8.686	23	6PCR-23-007	2-1546399-8
8.311	22	6PCR-22-007	2-1546399-7
7.936	21	6PCR-21-007	2-1546399-6
7.561	20	6PCR-20-007	2-1546399-5
7.186	19	6PCR-19-007	2-1546399-4
6.811	18	6PCR-18-007	2-1546399-3
6.436	17	6PCR-17-007	2-1546399-2
6.061	16	6PCR-16-007	2-1546399-1
5.686	15	6PCR-15-007	2-1546399-0
5.311	14	6PCR-14-007	1-1546399-9
4.936	13	6PCR-13-007	1-1546399-8
4.561	12	6PCR-12-1381	2-796988-3
4.561	12	6PCR-12-1382	2-796988-9
4.561	12	6PCR-12-007	1-1437652-4
4.186	11	6PCR-11-007	1-1546399-7
3.811	10	6PCR-10-007	1-1546399-6
3.436	9	6PCR-09-007	1-1546399-5
3.061	8	6PCR-08-003	3-1546158-4
3.061	8	6PCR-08-1383	796905-1
3.061	8	6PCR-08-007	3-1546158-3
2.686	7	6PCR-07-014	9-1437651-3
2.686	7	6PCR-07-007	9-1437651-2
2.311	6	6PCR-06-007	8-1437651-8
1.936	5	6PCR-05-007	1-1546399-4
1.561	4	6PCR-04-007	7-1437651-8
1.186	3	6PCR-03-1224	7-1437651-0
1.186	3	6PCR-03-007	1-1546160-9
.811	2	6PCR-02-003	2-1546158-6
.811	2	6PCR-02-007	6-1437651-3

1 SEE FIGURE
 SEE FIGURE

3 OBSOLETE

2 SEE FIGURE

SEE FIGURE

SEE FIGURE 1

2

THIS DRAWING IS A CONTROLLED DOCUMENT.

DWN	S SCHLEGEL	5/21/04
CHK	S YODER	5/21/04
APVD	S YODER	5/21/04

TE Connectivity

6PCR-XX-007

SIZE	CAGE CODE	DRAWING NO	RESTRICTED TO
A2	00779	6-1437651-3	-

CUSTOMER DRAWING

SCALE: NTS SHEET: 1 of 1 REV: A3

X-ON Electronics

Largest Supplier of Electrical and Electronic Components

Click to view similar products for [Barrier Terminal Blocks](#) category:

Click to view products by [TE Connectivity](#) manufacturer:

Other Similar products are found below :

[CR151D20104](#) [670A-RZ-15-KT20](#) [6C1N03](#) [6PCR-02](#) [6PCR-02-008](#) [6PCR-05-008](#) [6PCR-08-008](#) [6PCR-09-008](#) [6PCR-13-006](#) [6PCR-15-006](#) [6PCR-21-006](#) [6PCV-06-008](#) [6PCV-06-716](#) [6PCV-09-001](#) [6PCV-10-009](#) [6PCV-15-008](#) [6PCV-17-1206](#) [6PCV-20-323](#) [6PCV-30-006](#) [6STR-06-006](#) [6STR-08-006](#) [6STR-12-008](#) [6STR-13-006](#) [6STR-14-008](#) [6STR-16-008](#) [6STR-17-008](#) [6STR-21-008](#) [6STR-25-008](#) [6STR-27-008](#) [6STV-03-006](#) [6STV-03-008](#) [6STV-04-006](#) [6STV-09-006](#) [6STV-10-006](#) [6WWR-03-693](#) [6WWV-12-008](#) [6WWV-16-008](#) [72212603](#) [72504-C-50](#) [72506-C](#) [72507-C-50](#) [73203](#) [75505-C](#) [75505-C-50](#) [75510-C](#) [77010-50](#) [7C1N08](#) [812-GP-3/4ST-09](#) [8-1437402-5](#) [8-1437402-7](#)